



the photoelectric specialist

Product Line Specifications

Standard OMNI-BEAM™ Sensors

Modular self-contained sensors with D.A.T.A.™ (Display And Trouble Alert)

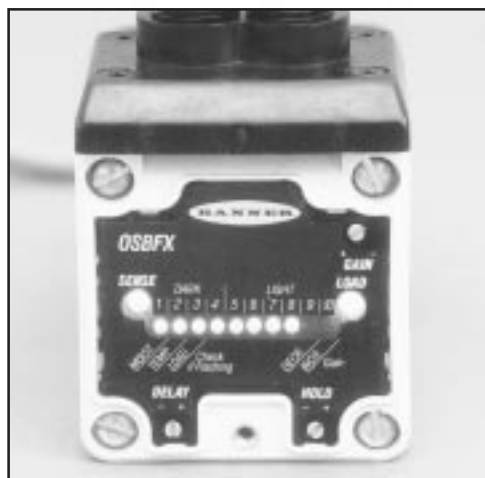
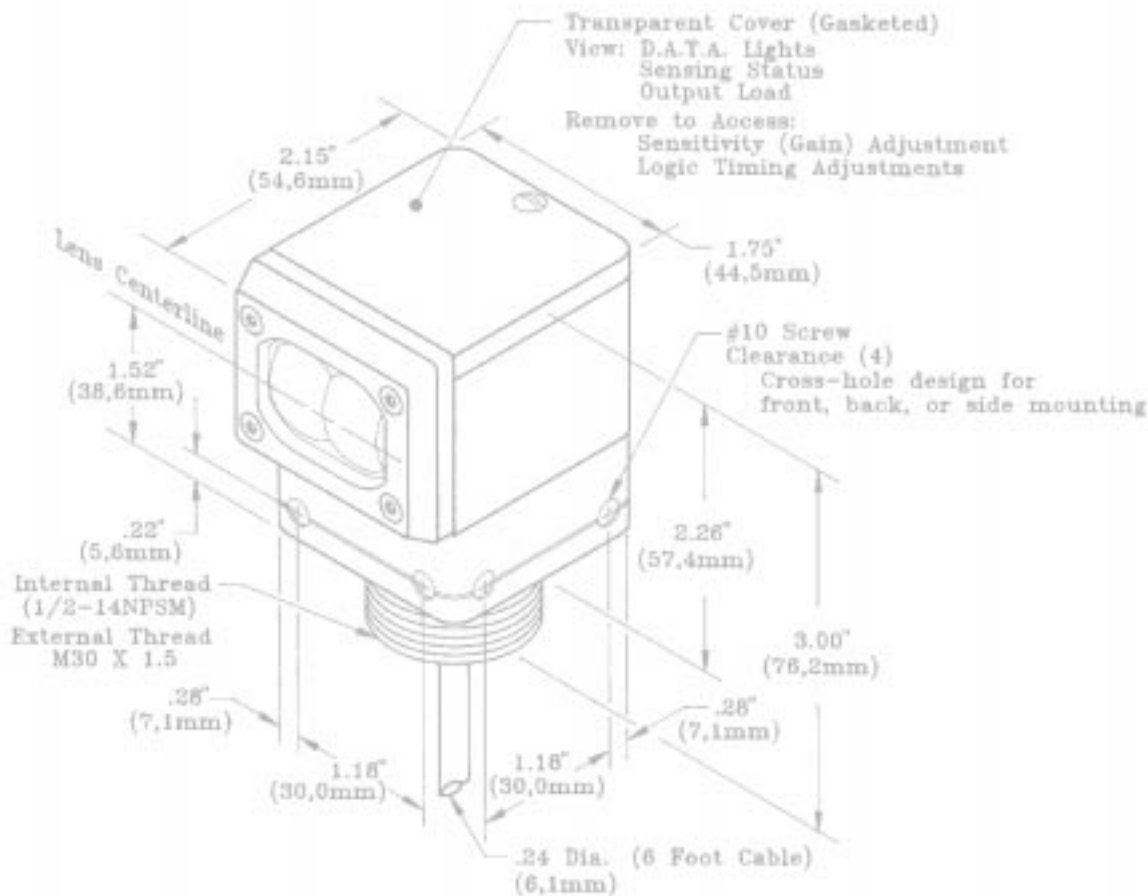

- Modular design with interchangeable components plus provision for optional timing modules
- D.A.T.A.™ (Display And Trouble Alert), a complete self-diagnostic system, displays an early warning of a sensing problem before a failure occurs, simplifying troubleshooting and preventing expensive down-time
- Choice of power blocks for AC or DC operation; DC models feature Bi-Modal™ output circuitry for *either* sinking or sourcing interface requirements
- Cross-hole design for front, back, or side mounting (standard limit-switch spacing), plus 30-mm threaded base mounting hub
- Models available in all sensing modes

Contents

Introduction to Standard OMNI-BEAM™ Modular Sensors	page 3
Summary of available models	page 4
Standard OMNI-BEAM™ Sensor Heads	
D.A.T.A. Self-diagnostic System	page 5
Measuring Excess Gain and Contrast	page 6
Sensor Head Programming	page 7
Descriptions and Specifications	pages 8 - 11
OSBFAC Sensor Head: AC-coupled Fiber Optic Mode	page 12
Standard OMNI-BEAM™ Power Blocks	
DC Power Blocks	page 13
AC Power Blocks	page 14
OMNI-BEAM™ Logic Modules	page 15
OMNI-BEAM™ Accessories	
Quick-disconnect Cables	page 16
2-axis Universal Mounting Bracket	page 16
Swivel Mounting Bracket	page 16



WARNING The photoelectric presence sensors described in this catalog do NOT include the self-checking redundant circuitry necessary to allow their use in personnel safety applications. A sensor failure or malfunction can result in *either* an energized or a de-energized sensor output condition.

Never use these products as sensing devices for personnel protection. Their use as a safety device may create an unsafe condition which could lead to serious injury or death.

Only MACHINE-GUARD and PERIMETER-GUARD Systems, and other systems so designated, are designed to meet OSHA and ANSI machine safety standards for point-of-operation guarding devices. No other Banner sensors or controls are designed to meet these standards, and they must NOT be used as sensing devices for personnel protection.

WARRANTY: Banner Engineering Corporation warrants its products to be free from defects for one year. Banner Engineering Corporation will repair or replace, free of charge, any product of its manufacture found to be defective at the time it is returned to the factory during the warranty period. This warranty does not cover damage or liability for the improper application of Banner products. This warranty is in lieu of any other warranty either expressed or implied.

Standard OMNI-BEAM™

Modular Self-contained Photoelectric Sensors

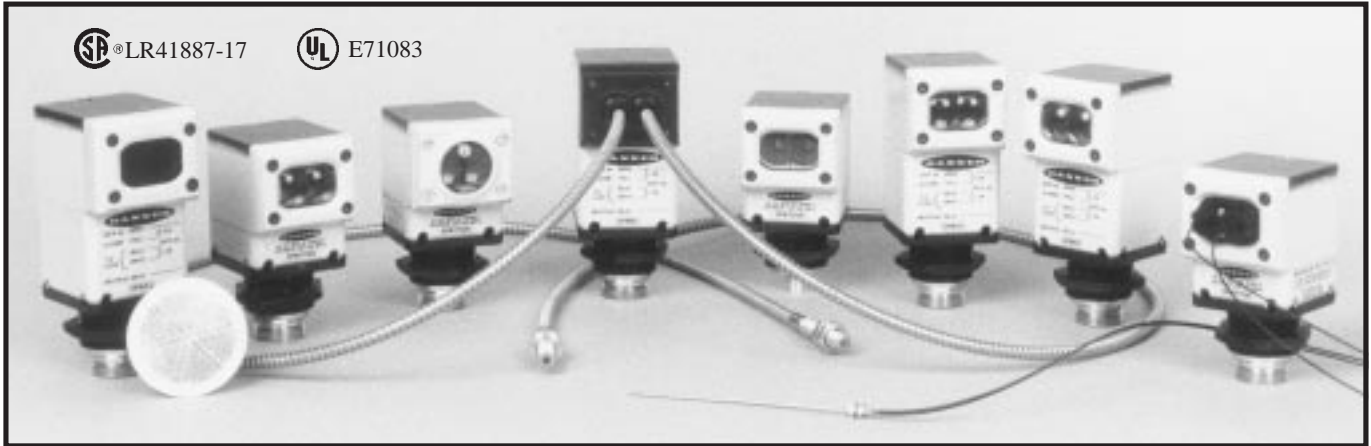

Standard OMNI-BEAMs are modular, self-contained photoelectric sensors consisting of a sensor head, a power block, and (optionally) an output timing logic module. Standard OMNI-BEAM sensor heads feature Banner's exclusive (US patent no. 4965548) **D.A.T.A.**™ (Display and Trouble Alert) indicator system. The **D.A.T.A.** system is a built-in 10-element LED array that displays sensing contrast and relative signal strength. When used along with the dedicated alarm output, it warns of impending sensing problems *before a failure occurs*, thereby preventing expensive down-time. The **D.A.T.A.** system indicator array is easily visible through a transparent, gasketed sensor head cover.

Modular design, using interchangeable components, allows for use of either ac (105-130V or 210-250V) or dc (10-30V) power blocks plus the easy addition of optional timing logic modules.

Standard OMNI-BEAM ac-operated power blocks feature a solid-state ac output relay. DC-operated power blocks feature another Banner exclusive, **Bi-Modal**™ output circuitry (US patent no. 4982107), for either sinking (NPN) or sourcing (PNP) interface requirements, depending upon the polarity with which the two dc power supply leads are connected. All sensing modes are available, including opposed, retroreflective, diffuse (proximity), convergent, and glass and plastic fiber optic.

All OMNI-BEAMs offer a choice of prewired cable or quick-disconnect cable fittings. OMNI-BEAM sensors have cross-hole design (with standard limit-switch hole spacing) for back, front, or side mounting, plus a 30mm threaded base mounting hub. An accessory right angle 11-gauge stainless steel adjustable mounting bracket (model SMB30MM) and a VALOX® swivel mount bracket (model SMB30SM, page 16) are available. All assembled OMNI-BEAM sensors are rated NEMA 1, 2, 3, 3S, 4, 12, and 13.

Ordering OMNI-BEAM Sensors

OMNI-BEAM sensors are ordered by specifying a sensor head module, a power block module, and an output timing logic module.

OMNI-BEAM's sensor head and power block bolt and plug together quickly and easily.

An optional timing logic module may be added at any time.

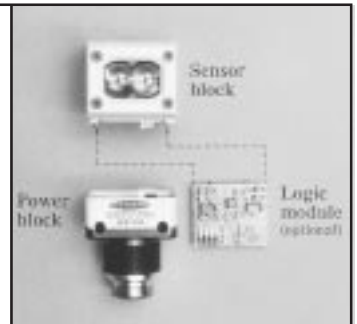

OMNI-BEAM Dimensions (with dc Power Block)

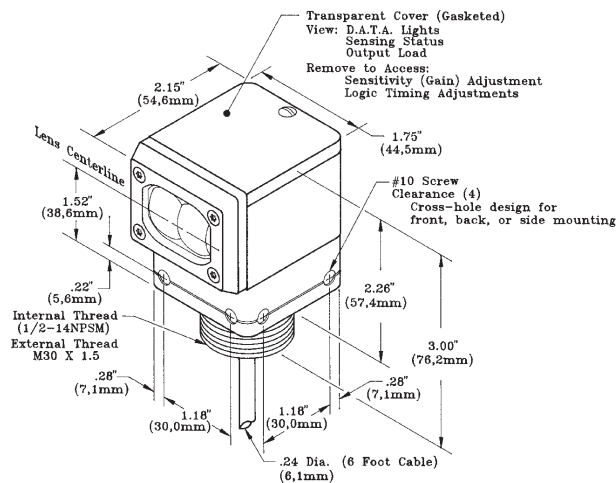

OMNI-BEAM Dimensions (with ac Power Block)

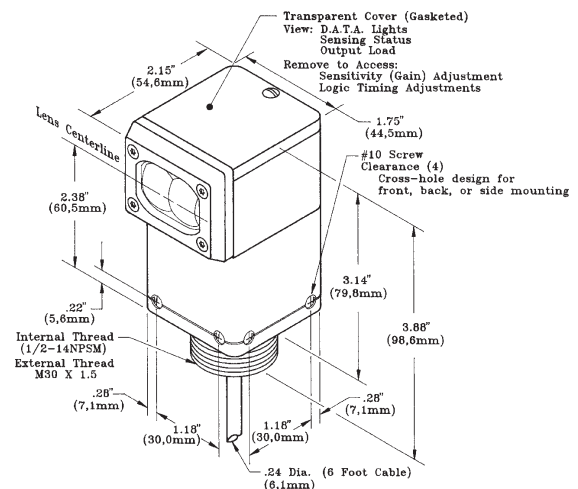

Standard OMNI-BEAM Sensors

OMNI-BEAM Standard Sensor Heads: summary of available models

Standard Sensor Heads	Sensing Mode	Range	Response	Page
	OSBE and OSBR	Opposed	150 feet	2 milliseconds 8
	OSBD	Diffuse (proximity); high speed	12 inches	2 milliseconds 8
	OSBDX	Diffuse (proximity); high power	6 feet	15 milliseconds 8
	OSBLV	Retroreflective	30 feet	4 milliseconds 8
	OSBLVAG	Retroreflective, polarized	15 feet	4 milliseconds 8
	OSBCV	Convergent	focus at 1.5"	4 milliseconds 9
	OSBF	Fiber optic (glass fibers); high speed, infrared	see specs	2 milliseconds 9
	OSBFX	Fiber optic (glass fibers); high power, infrared	see specs	15 milliseconds 10
	OSBFV	Fiber optic (glass fibers); high speed; visible red	see specs	2 milliseconds 10
	OSBEF & OSBRF	Opposed fiber optic (glass fibers); infrared	see specs	2 milliseconds 11
	OSBFP	Fiber optic (plastic fibers); visible red	see specs	2 milliseconds 11
	OSBFAC	AC-coupled fiber optic mode (glass fibers)	see specs	see specs 12

OMNI-BEAM Standard Power Blocks: summary of available models

Standard Power Blocks	Input Voltage	Output Configuration	Cable or QD*	Page
	OPBA2	105 to 130V ac	Solid-state ac relay	6' cable 14
	OPBB2	210 to 250V ac	Solid-state ac relay	6' cable 14
	OPBA2QD	105 to 130V ac	Solid-state ac relay	QD fitting, mini 14
	OPBB2QD	210 to 250V ac	Solid-state ac relay	QD fitting, mini 14
	OPBAE	105 to 130V ac	No output: for powering emitter only	6' cable 14
	OPBBE	210 to 250V ac	No output: for powering emitter only	6' cable 14
	OPBAEQD	105 to 130V ac	No output: for powering emitter only	QD fitting, mini 14
	OPBBEQD	210 to 250V ac	No output: for powering emitter only	QD fitting, mini 14
	OPBT2	10 to 30V dc	Bi-Modal; NPN sinking or PNP sourcing	6' cable 13
	OPBT2QD	10 to 30V dc	Bi-Modal; NPN sinking or PNP sourcing	QD fitting, mini 13
	OPBT2QDH	10 to 30V dc	Bi-Modal; NPN sinking or PNP sourcing	QD fitting, euro 13
	OPBTE	10 to 30V dc	No output: for powering emitter only	6' cable 13
	OPBTEQD	10 to 30V dc	No output: for powering emitter only	QD fitting, mini 13
	OPBTEQDH	10 to 30V dc	No output: for powering emitter only	QD fitting, euro 13

*minifast™ or eurofast™

OMNI-BEAM Output Logic Modules: summary of available models

Logic Modules (page 15)

Timing Function



OLM5	Delay timer module (on delay, off delay, or on/off delay; 0.1 to 15 seconds)
OLM8	Pulse timer module (one-shot or delayed one-shot; 15 seconds max. pulse, 15 seconds max. delay)
OLM8M1	Pulse timer module (one-shot or delayed one-shot; 1.5 seconds max. pulse, 1.5 seconds max. delay)

NOTES

- 1) QD and QDH model power blocks have integral QD (Quick Disconnect) fitting; all other models have attached 6-foot PVC-covered cable.
- 2) For complete information, see the referenced pages.

Standard OMNI-BEAM Sensor Heads

D.A.T.A.TM (patent #4965548) Sensor Self-diagnostic System

Banner's exclusive D.A.T.A. (Display and Trouble Alert) system warns of marginal sensing conditions usually before a sensing failure occurs. This self-checking diagnostic system warns of a problem by flashing one or more lights in a multiple-LED array, and by sending a warning signal to the system logic controller (or directly to an audible or visual alarm) by way of the OMNI-BEAM's dedicated alarm output.

The D.A.T.A. lights are located on the top of the sensor head and are viewed through a transparent LEXAN® cover. The D.A.T.A. lights are configured as follows:



- ① **Moisture Alert:** Severe moisture *inside* the sensor head, caused by condensation or by entry of moisture when the access cover is removed, will cause the #1 light to flash.
- ② **High Temperature Alert:** When the temperature *inside* the sensor head exceeds 70°C (+158°F), the #2 light will flash.
- ③ **Low Voltage or Overload Alert:** The number #3 light will flash whenever the sensor supply voltage drops below the minimum that is specified for the power block in use (see power block specifications, pages 12 and 13). Power block outputs are also shut down to prevent damage to the load(s) from low voltage.

When using dc power block models OPBT2, OPBT2QD, or OPBT2QDH, the #3 light will flash if either the load output or the alarm output becomes shorted. Both outputs will be inhibited, and the circuit will "retry" the outputs every 1/10 second. The outputs will automatically reset and function normally when the short is corrected.

- ⑨ **High Gain Warning:** The #9 light will flash if the "dark" signal never goes below #4 on the display, and instruct the operator to decrease the gain (see photo above). There are two possible conditions:
 - 1) The **High Gain Warning** alarm will come "on" if the "dark" signal slowly increases to the #4 level and remains at that level for a predetermined delay time. This condition is commonly caused by an increase (over time) of unwanted background reflections when using reflective sensing modes, such as diffuse (proximity) and convergent beam. The alarm will reset as soon as the cause of the unwanted light signal is removed, or if the GAIN control setting is reduced to bring the "dark" condition below the #4 level.
 - 2) The **High Gain Warning** alarm will latch "on" if the "dark" signal does not fall below the #4 level during a sensing event. The alarm is automatically reset on any subsequent sensing event in which the "dark" sensing level falls below the #4 level. This is accomplished by reducing the GAIN control setting and/or by removing the cause of the unwanted light return in the "dark" condition.
- ⑩ **Low Gain Warning:** The #10 light will flash if the "light" signal never goes above #5 on the display, and instruct the operator to increase the gain (see photo, above). There are two possible conditions:
 - 1) The **Low Gain Warning** alarm will come "on" if the light signal slowly decreases to the #5 level and remains at that level for a predetermined delay time. This situation most commonly occurs in opposed or retroreflective sensing systems, and is caused by a decrease in light in the unblocked condition (over time) due to obscured lenses or gradual sensor misalignment. The alarm will reset as soon as the light signal strength exceeds the #5 level.
 - 2) The **Low Gain Warning** alarm will latch "on" if the light signal does not exceed the #5 level during a sensing event. The alarm is automatically reset by any subsequent sensing event in which the "light" signal exceeds the #5 level. This is accomplished by increasing the GAIN control setting and/or by lens cleaning and sensor realignment.
- ⑨ + ⑩ **Low Contrast Warning:** The #9 and #10 D.A.T.A. lights will flash simultaneously to indicate that there is not enough optical contrast for reliable sensing. This occurs when the "light" condition is at the #5 level and the "dark" condition is at the #4 level for a sensing event. If this warning occurs, the application should be fully re-evaluated to find ways to increase the differential between the "light" and "dark" conditions. The **Low Contrast** alarm is automatically reset by any subsequent sensing event in which the "light" signal exceeds the #5 level and the "dark" signal falls below the #4 level.

SENSE and LOAD Indicator LEDs



The SENSE LED indicates when a target has been sensed. When the sensor head is programmed for LIGHT operate, it lights when the sensor receives enough light to exceed the #5 threshold. When programmed for DARK operate, it lights when the received signal falls below the #5 threshold. The SENSE LED is located at the far left end of the D.A.T.A. array.



The LOAD indicator LED lights whenever the load is energized (after the timing function, if any). The LOAD LED is located at the far right end of the D.A.T.A. array.

The SENSE and LOAD indicator LED locations are visible in the photograph above.

Standard OMNI-BEAM Sensor Heads

Measuring Excess Gain and Contrast

The OMNI-BEAM's **D.A.T.A.** lights may be used to measure the *excess gain* and *contrast* in any sensing situation and during installation and maintenance.

Excess gain is a measurement of the amount of light energy falling on the receiver of a photoelectric sensor *over and above the minimum amount necessary to operate the sensor's amplifier*. Excess gain is expressed as a ratio:

$$\text{Excess gain (E.G.)} = \frac{\text{light energy falling on receiver}}{\text{amplifier threshold}}$$

The amplifier threshold is the point at which the sensor's output switches. The OMNI-BEAM's threshold corresponds to the #5 level of the **D.A.T.A.** light array. That is, when LEDs #1 through #5 are lit, the excess gain of the received light signal is equal to "1x".

The table below (*Relationship between Excess Gain and D.A.T.A. System Lights*) shows how excess gain relates to the **D.A.T.A.** light array indication.

Relationship between Excess Gain and D.A.T.A. System Lights

D.A.T.A. light LED number	STANDARD scale factor	FINE* scale factor	D.A.T.A. light LED number	STANDARD scale factor	FINE* scale factor
#1	0.25x E.G.	0.5x E.G.	#6	1.3x	1.1x
#2	0.35x	0.7x	#7	1.7x	1.2x
#3	0.5x	0.8x	#8	2.2x	1.3x
#4	0.7x	0.9x	#9	2.9x	1.7x
#5	1.0x	1.0x	#10	3.7x (or more)	2.2x (or more)

*NOTE: the scale factor is selected by programming switch #4 inside the sensor head (see page 7). "OFF" = STANDARD; "ON" = FINE. Use the FINE scale only for setup and monitoring of close-differential sensing applications where LOW hysteresis is required.

Contrast is the ratio of the amount of light falling on the receiver in the "light" state as compared to the "dark" state. Contrast is also referred to as "light-to-dark ratio". Optimizing the contrast in any sensing situation will increase the reliability of the sensing system. Contrast may be calculated if excess gain values are known for both the light and dark conditions:

$$\text{Contrast} = \frac{\text{Excess gain (light condition)}}{\text{Excess gain (dark condition)}}$$

To determine the contrast for any sensing application, present both the "light" and "dark" conditions to the OMNI-BEAM, and read the **D.A.T.A.** signal for each. Take the ratio of the two numbers (from the table above) that correspond to the highest **D.A.T.A.** light numbers registered for the "light" and "dark" conditions.

For example, if LEDs #1 through #8 come "on" in the "light" condition and LEDs #1 and #2 come "on" in the "dark" condition (as shown in the photos at right), the contrast (referring to the table at the top of this page) is calculated as follows:

$$\text{Contrast} = \frac{2.2x}{0.35x} = 6$$

This value is expressed as "6:1" or "six-to-one".

The **best** sensor adjustment will cause all ten **D.A.T.A.** LEDs to come "on" for the "light" condition, and will cause no LEDs to come "on" in the "dark" condition. In this situation (such as an application in which a box breaks a the beam of an opposed mode emitter and receiver):

$$\text{Contrast is greater than } \frac{3.7x}{0.25x} = 15:1$$

Contrast Values and Corresponding Guidelines

Contrast Ratio	Recommendation
1.2 or less	Unreliable. Evaluate alternative sensing schemes.
1.2 to 2	Poor contrast. Use the LOW hysteresis setting and the FINE scale factor.
2 to 3	Low contrast. Sensing environment must remain perfectly clean and all other sensing variables must remain stable.
3 to 10	Good contrast. Minor sensing system variables will not affect sensing reliability.
10 or greater	Excellent contrast. Sensing should remain reliable as long as the sensing system has enough excess gain for operation.



DARK condition example: **D.A.T.A.** system LEDs #1 and #2 lit.



LIGHT condition example: **D.A.T.A.** system LEDs #1 through #8 lit.

Of course, it is not always possible to adjust a sensor to maintain this much contrast. However, *it is important to always adjust a sensor for the greatest amount of contrast possible for any sensing situation.* The **D.A.T.A.** light system makes this easy. The **Contrast Values and Corresponding Guidelines** table (above) gives general guidelines for contrast values.

Standard OMNI-BEAM Sensor Heads

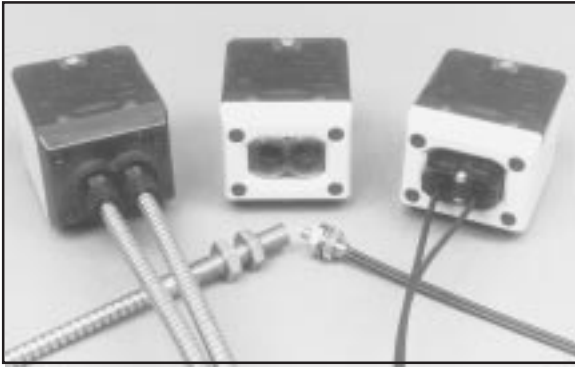

Standard OMNI-BEAM sensor head modules are available in all photoelectric sensing modes: opposed, retroreflective, diffuse (proximity), convergent-beam, and fiber optic (both glass and plastic). They offer the same outstanding optical performance as established by Banner's MULTI-BEAM and MAXI-BEAM sensor families.

Construction: Standard OMNI-BEAM sensor heads are molded from rugged VALOX® thermoplastic polyester for outstanding electrical and mechanical performance in demanding applications. The top view window is LEXAN® polycarbonate. Lenses are acrylic. Hardware is stainless steel. When assembled, all parts are fully gasketed. Standard OMNI-BEAM sensor heads are rated NEMA 1, 2, 3, 3S, 4, 12, and 13.

Operating Temperature Range: -40 to +70°C (-40 to +158°F).

Delay upon Power-up: 200 milliseconds maximum (power block outputs are non-conducting during this time)

Sensor Head Programming

Standard OMNI-BEAM sensor heads are field-programmable for four operating parameters. A set of four programming DIP switches is located at the base of the sensor head (see photo at right), and is accessible with the sensor block removed from the power block.

Switch #1 selects the amount of sensing hysteresis. Hysteresis is an electronic sensor design consideration which states that the amount of received light signal required to operate the sensor's output is not the same as the amount required to release the output. This differential prevents the sensing output from "buzzing" or "chattering" when a light signal at or near the sensing threshold level is detected.

Setting switch #1 to the "on" position programs the sensor head for "normal" hysteresis. *The NORMAL setting should be used always, except for low-contrast situations like the detection of subtle differences in reflectivity.* NOTE: the "low" hysteresis setting (switch #1 "off") should be used only when all sensing conditions remain completely stable.

Switch #2 selects the alarm output configuration. With switch #2 "on", the alarm output is normally open (i. e., it conducts with an alarm). Turning switch #2 "off" programs the alarm output for normally closed operation (i. e., the output opens during an alarm).

The normally closed mode (switch #2 "off") is recommended. This allows a system controller to recognize a sensor power loss or an open sensor output as an alarm condition. The normally open alarm mode (switch #2 "on") should be used when the alarm outputs of multiple Standard OMNI-BEAMs are wired in parallel to a common alarm or alarm input.

Switch #3 selects LIGHT operate (switch #3 "off") or DARK operate (switch #3 "on"). In the LIGHT operate mode, the OMNI-BEAM's load output will energize (after a time delay, if timing logic is employed) when the received light level is *greater* than the sensing threshold (i. e., when five or more **D.A.T.A.** lights are illuminated). In DARK operate, the output will energize (after a time delay, if any) when the received light level is *less* than the sensing threshold (i. e., when four or less **D.A.T.A.** lights are illuminated).

For example, when sensing in a beam-break mode like opposed or retroreflective:

- 1) The DARK operate mode would be used to energize the OMNI-BEAM's output whenever an object is present, and *blocking the beam*.
- 2) The LIGHT operate mode would be used to energize the output whenever the beam is *unblocked* (i. e., object missing).

Similarly, when using a reflective sensing mode like diffuse (proximity) or convergent-beam:

- 1) The LIGHT operate mode would be used to energize the OMNI-BEAM's output whenever an object is present in front of the sensor, *reflecting the light beam back to the receiver*.
- 2) The DARK operate mode would be used to energize the output whenever the reflection is lost (i. e., object missing).

Switch #4 selects the STANDARD (switch #4 "off") or FINE (switch #4 "on") scale factor for the **D.A.T.A.** light signal strength indicator array. This switch should always be in the "off" position, except for close differential sensing situations, like *some* color registration applications, which also require the LOW hysteresis setting (switch #1 "off").

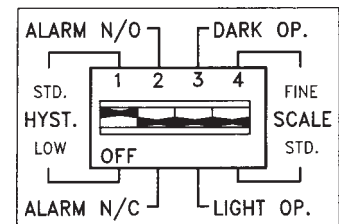
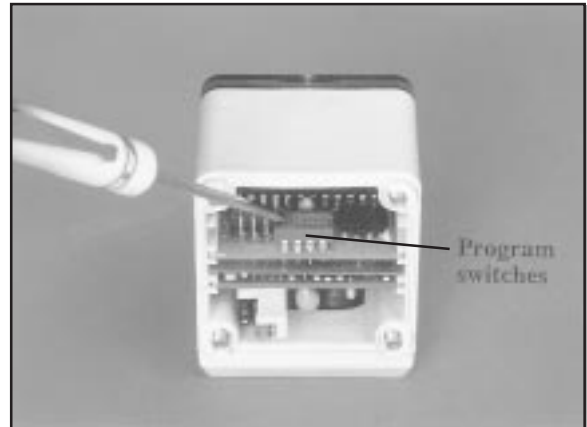

Factory settings:

The following are the factory program settings for OMNI-BEAM sensor heads.

Switch #1: "on" = normal hysteresis

Switch #3: "off" = light operate of load output

Switch #2: "off" = normally closed alarm output

Switch #4: "off" = standard scale factor for signal strength meter

Standard OMNI-BEAM Sensor Heads

Sensing Mode and Models

Excess Gain

Beam Pattern

OPPOSED Mode



OSBE & OSBR

Range: 150 feet (45m)
Beam: infrared, 880nm
Response: 2ms
Repeatability: 0.01ms
Effective Beam: 1" dia.

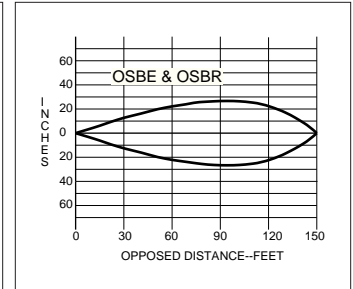
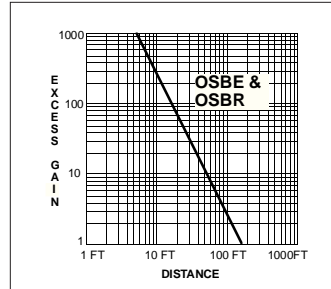
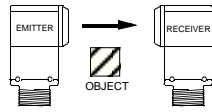

HIGH-SPEED DIFFUSE (PROXIMITY) Mode



OSBD

Range: 12 inches (30cm)
Beam: infrared, 880nm
Response: 2ms
Repeatability: 0.1ms

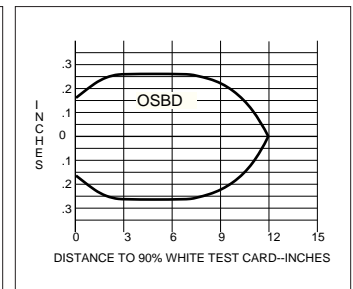
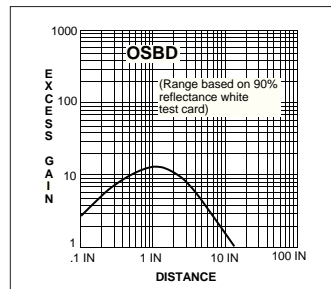
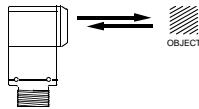

HIGH-POWER DIFFUSE (PROXIMITY) Mode

Diffuse (proximity) mode sensors detect objects by sensing their own emitted light reflected from the object. They are ideal for use when the reflectivity and profile of the object to be detected are sufficient to return a large percentage of emitted light back to the sensor. Model OSBDX is the first choice for diffuse (proximity) mode applications when there is no requirement for less than 15ms response and where there are no background objects to falsely return light.

OSBDX

Range: 6 feet (2m)
Beam: infrared, 880nm
Response: 15ms
Repeatability: 1ms

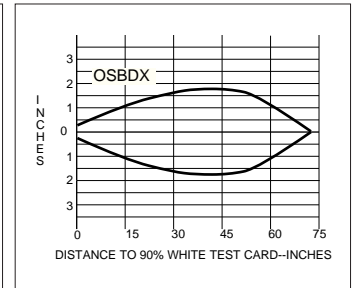
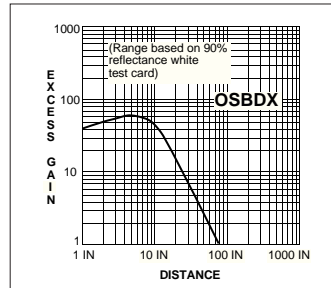

RETROREFLECTIVE Mode



OSBLV

Range: 6 inches to 30 feet
 (0,15 to 9m)
Beam: visible red, 650nm
Response: 4ms
Repeatability: 0.2ms

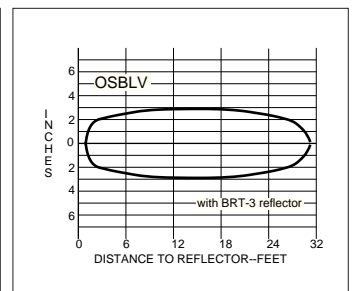
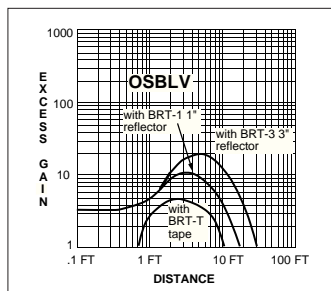
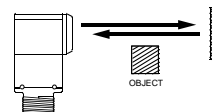

POLARIZED RETRO Mode

The visible red sensing beam of these retroreflective sensors makes them very easy to align. The "AG" (anti-glare) model polarizes the emitted light and filters out unwanted reflections, making sensing possible in applications otherwise considered unsuited to retroreflective sensing. Use "AG" models only in very clean environments, and use with the model BRT-3 3" reflector. NOTE: for detailed information on retroreflective targets, see the Banner product catalog.

OSBLVAG

Range: 12 inches to 15 feet
 (0,3 to 4,5m)
Beam: visible red, 650nm
Response: 4ms
Repeatability: 0.2ms

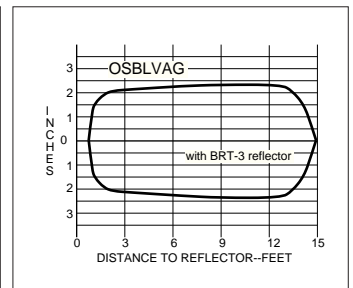
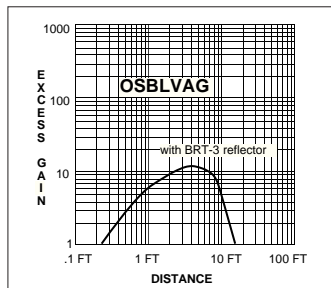

Standard OMNI-BEAM Sensor Heads

Sensing Mode and Models

Excess Gain

Beam Pattern

CONVERGENT Mode



OSBCV

Range: focus at 1.5 inches (38mm)
Beam: visible red, 650nm
Response: 4ms
Repeatability: 0.2ms

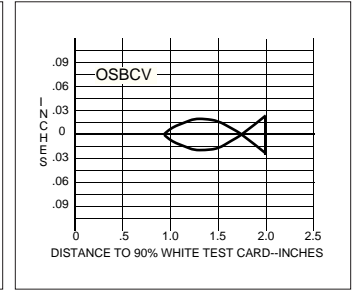
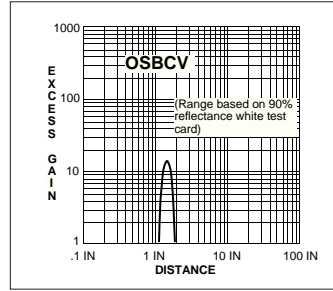
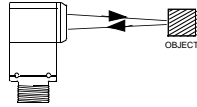

These sensors are ideal for reflective sensing of very small parts or profiles, and can accurately sense the position of parts approaching from the side. The OSBCV will ignore all but highly reflective objects which are beyond its sensing depth of field, and

produces a visible red sensing spot which greatly simplifies alignment and makes it useful in many high-contrast color registration applications.

Sensing spot size at focus point is 0.05 inch (1,3mm) in diameter.

HIGH-SPEED FIBER OPTIC Mode (glass fibers)



OSBF

Range: see excess gain curves
Beam: infrared, 880nm
Response: 2ms
Repeatability: 0.1ms

Opposed Fiber Optic Mode

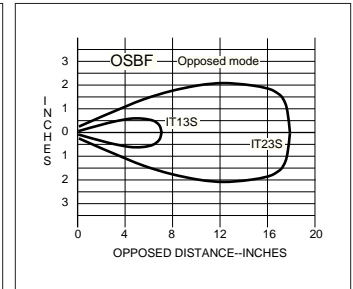
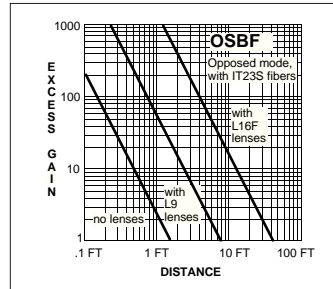

Fiber optics (sometimes called "light pipes") are often used to sense small parts. Small parts or narrow profiles which move at a high rate of speed can require sensors with fast response times for reliable detection.

High speed fiber optic sensor heads, such as model OSBF, are ideal for sensing gear or sprocket teeth or other targets in applications involving counters or shift registers for position control. Selection of the fiber optic sensing tip should involve matching the effective beam of the fiber to the profile of the part to be sensed to maximize the time that the part is sensed and/or the time between adjacent parts. Combining the best selection of fiber tip geometry with a high speed sensor will result in a highly repeatable position sensing system.

The model BT13S fiber optic assembly used with a model L9 or L16F lens and an OMNI-BEAM using a model OSBF sensor head is an excellent system for retroreflective code reading or for almost any short range retroreflective sensing application.

Retroreflective Fiber Optic Mode

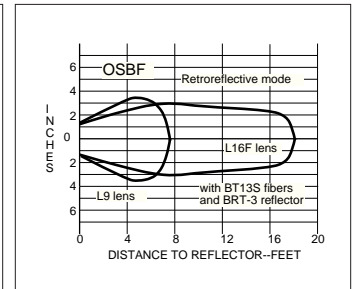
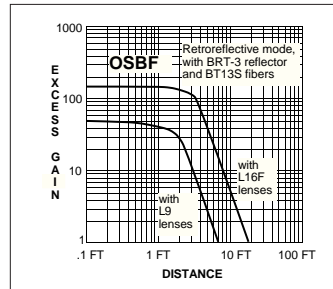

Diffuse Fiber Optic Mode

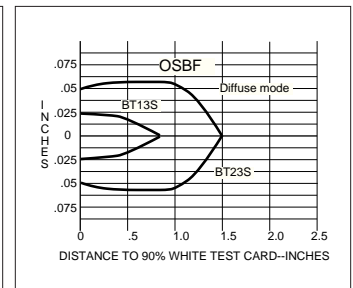
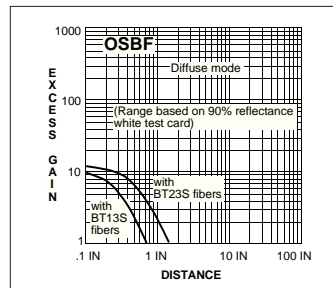

Standard OMNI-BEAM Sensor Heads

Sensing Mode and Models

Excess Gain

Beam Pattern



HIGH-POWER FIBER OPTIC Mode (glass fibers)

OSBFX

Range: see excess gain curves
Beam: infrared, 880nm
Response: 15ms
Repeatability: 1ms

Opposed Mode

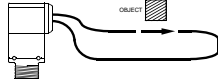

Diffuse Mode

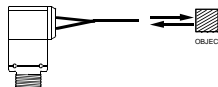

Model OSBFX is the first choice for glass fiber optic applications, except in fiber optic retroreflective applications or where faster response speed or visible light are a requirement. Excess gain is the highest available in the photoelectric industry. As a result, opposed individual fibers operate reliably in many very hostile environments. Also, special miniature bifurcated fiber optic assemblies with bundle sizes as small as .020 inch (.5mm) in diameter may be used successfully for diffuse mode sensing. The excess gain curves and beam patterns illustrate response with standard .060 inch (1.5mm) diameter and .12 inch (3mm) diameter bundles. Response for smaller or larger bundle sizes may be interpolated.

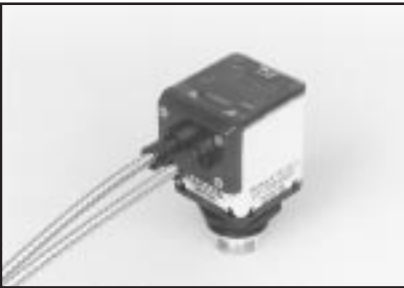
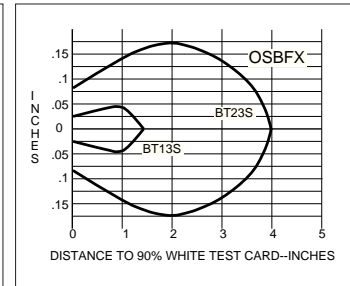
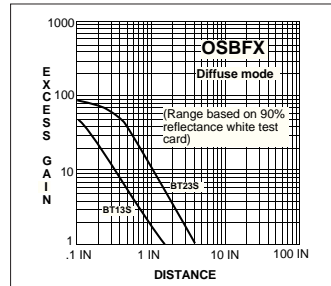
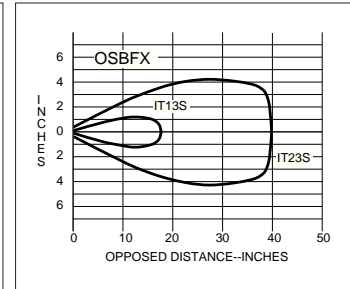
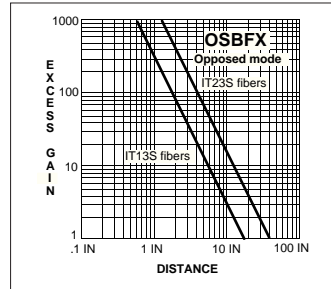

VISIBLE-LIGHT FIBER OPTIC Mode (glass fibers)

OSBFV

Range: see excess gain curves
Beam: visible red, 650
Response: 2ms
Repeatability: 0.1ms

Opposed Mode

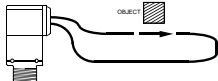

Retroreflective Mode

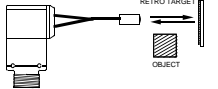

Diffuse Mode

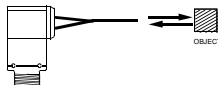

Model OSBFV is a visible-light version of the model OSBF. It is compatible with Banner individual and bifurcated glass fiber optic assemblies.

The visible red light source of the OSBFV increases optical contrast in many sensing situations, which makes it particularly useful for most applications involving diffuse-mode color registration sensing. (An important exception is applications involving red-on-white contrasts, which require a green light source.)

The OSBFV is also well suited to presence sensing of translucent materials and registration mark sensing on clear webs in the opposed mode, and for code-reading and/or short-range or narrow-beam sensing in the retroreflective mode.

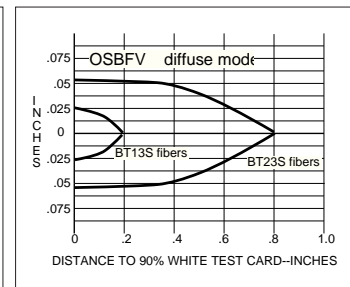
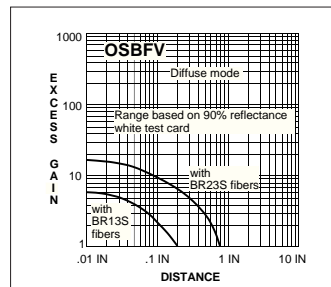
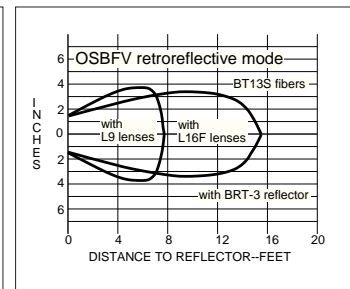
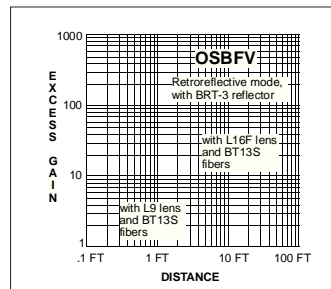
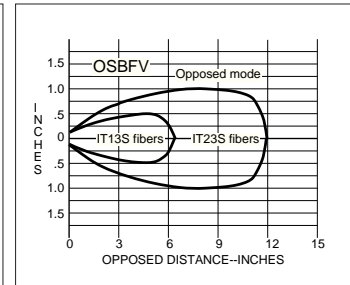
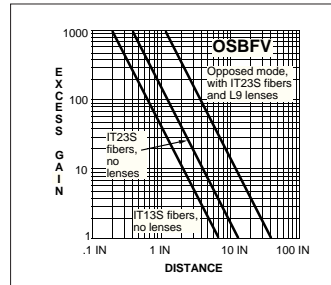

Standard OMNI-BEAM Sensor Heads

Sensing Mode and Models

Excess Gain

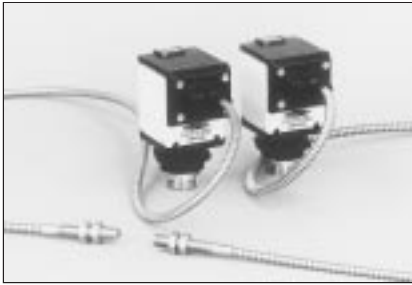

OPPOSED FIBER OPTIC Mode (glass fibers)

OSBEF and OSBRF

Range: see excess gain curves
Beam: infrared, 880nm
Response: 2ms
Repeatability: 0.01ms

The OSBEF/OSBRF opposed mode infrared fiber optic pair is compatible with Banner glass fiber optics. Because the emitter and receiver are separate units, they are ideal for applications in which it is inconvenient to route fiber optic assemblies to both sides of a process from a single sensor.

Emitters and receivers each have two active fiber optic ports, which makes it possible to configure two pairs of opposed fibers for "both parts present" (two-channel DARK AND) logic.

Opposed Mode

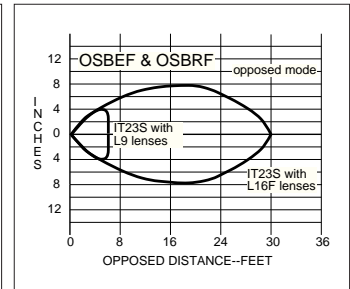
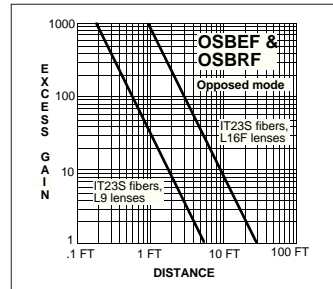
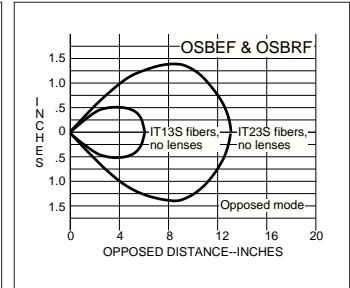
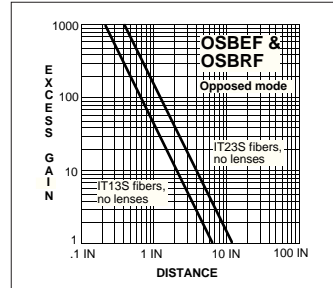
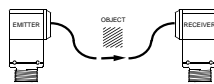

FIBER OPTIC Mode (plastic fibers)

OSBFP

Range: see excess gain curves
Beam: visible red, 650nm
Response: 2ms
Repeatability: 0.1ms

Plastic fiber optics are lower in cost than glass fiber optics, and are ideal for use in situations where environmental conditions allow (see information below). They are easily cut to length in the field, and are available in a variety of sensing end styles. For further information, refer to the Banner product catalog.

Opposed Mode



Diffuse Mode

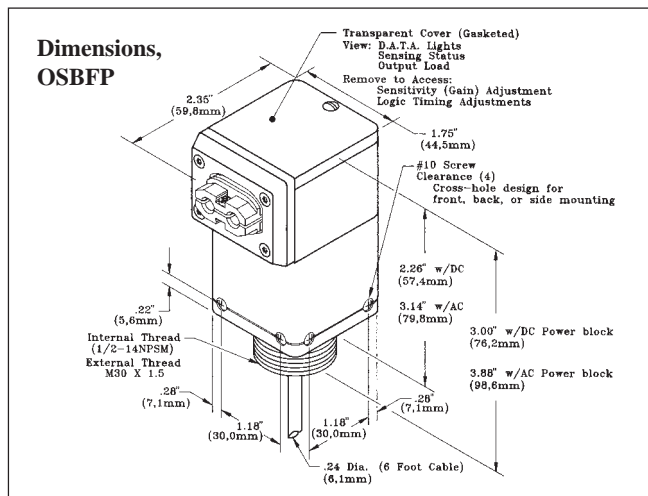
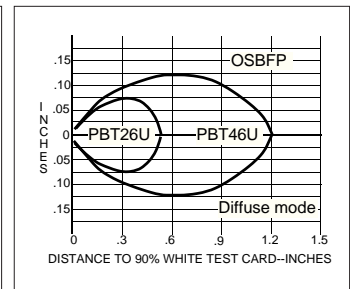
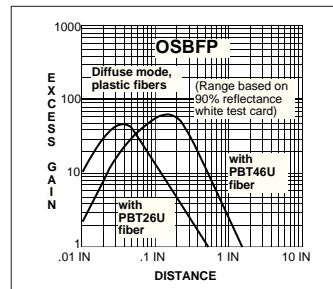
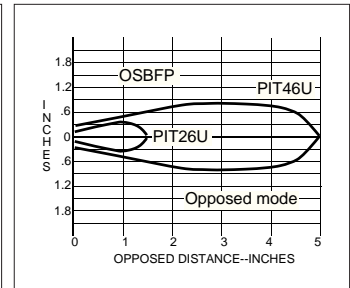
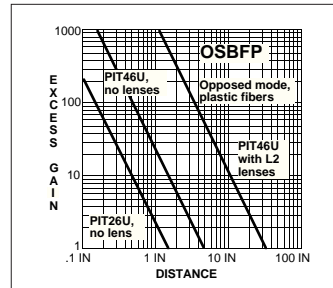
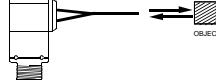

ENVIRONMENTAL FACTORS FOR PLASTIC FIBER OPTICS

OPERATING TEMPERATURE OF PLASTIC FIBER OPTIC ASSEMBLIES:
 -30 to +70 degrees C (-20 to +158 degrees F).

CHEMICAL RESISTANCE OF PLASTIC FIBER OPTIC ASSEMBLIES:
 the acrylic core of the monofilament optical fiber will be damaged by contact with acids, strong bases (alkalis), and solvents. The polyethylene jacket will protect the optical fiber from most chemical environments; however, materials may migrate through the jacket with long-term exposure. Samples of plastic fiber optic material are available from Banner for testing and evaluation.

OSBFAC AC-coupled Fiber Optic Sensor Head

The OMNI-BEAM™ model OSBFAC is a special-purpose ac-coupled fiber optic sensor head module. It is intended for applications in which the light signal change is so small that sensitivity adjustment of ordinary dc-coupled sensors is difficult or impossible. The OSBFAC responds to even smaller signal changes than do standard fiber optic OMNI-BEAM sensors set for LOW hysteresis, and is less affected by gradual signal changes due to dirt buildup, etc. Typical applications include thread break detection, web flaw detection, and detection of small parts falling randomly from vibratory feeders or small presses.

Many such low-contrast photoelectric sensing applications present problems to dc-coupled sensors because of *switching hysteresis*. Switching hysteresis is a designed-in property of dc-coupled sensors that causes the "turn-on" point of the sensor's dc-coupled amplifier to be slightly different than the "turn-off" point. Its purpose is to prevent "indecision" and erratic operation of the sensor's output circuit when the light signal is at or near the switching point of the dc-coupled amplifier.

The OSBFAC, with its ac-coupled amplifier, reliably amplifies the small signal changes found in many low-contrast sensing applications. An automatic gain control (AGC) feedback system locks onto the light signal and continually adjusts the light intensity of the emitter so that the system is always maintained at exactly the desired reference level regardless of the sensing range or degree of environmental contamination. A multi-turn GAIN control enables setting of the amplifier sensitivity.

Instead of the D.A.T.A.™ array of other OSB Series sensor heads, the OSBFAC has a LOCK indicator LED that lights when the AGC circuit has locked onto the signal, and a LOAD indicator LED that lights whenever the sensor's output circuit is energized. Both LEDs are easily visible beneath the OSBFAC's transparent LEXAN® top cover.

A slide switch inside the base of the OSBFAC sensor head selects either light- or dark-operate. When light operate is selected, output occurs on a dark-to-light transition. When dark-operate is selected, output occurs on a light-to-dark transition. *The OSBFAC requires use of the model OLM8 or OLM8M1 slide-in logic module.* Sensor head output is in the form of a quick pulse, and an OLM8 Series module is used to condition this pulse to the desired length. See page 15 for further information on these logic modules.

The OSBFAC ac-coupled fiber optic sensor head may be used with any of the following OMNI-BEAM power block models: OPBT2 and OPBT2QD (powered by 10 to 30V dc); OPBA2 and OPBA2QD (powered by 105 to 130V ac); or OPBB2 and OPBB2QD (powered by 210 to 250V ac). See pages 13 and 14 for power block information.

Model OSBFAC with power block and rectangular fiber optics attached.

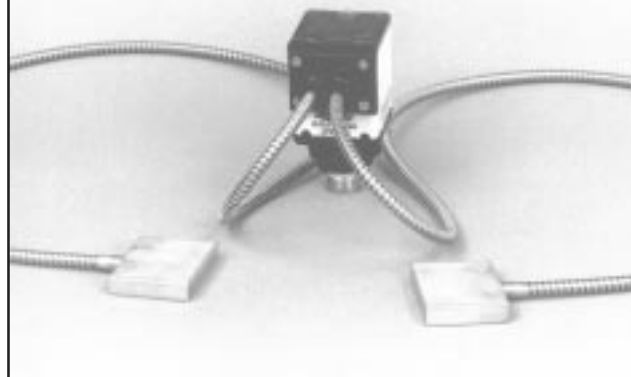

Typical OSBFAC application

The OSBFAC detects small parts falling randomly from a vibratory feeder.

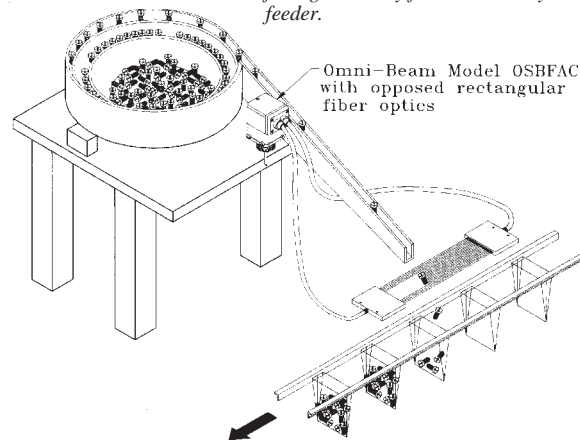

Sensing modes and ranges*, model OSBFAC

Opposed: 1/16-inch fibers, no lenses	3.5 inches
Opposed: 1/8-inch fibers, no lenses	7.0 inches
Opposed: 1/8-inch fibers, L9 lenses	5.3 feet
Opposed: 1/8-inch fibers, L16F lenses	17.8 feet
Diffuse: 1/8-inch fiber, no lens	0.6 inches**
Retro: 1/8-inch fiber, L9 lens, BRT-3 target	2.3 feet

*Minimum guaranteed ranges **Distance to white test card

Specifications, model OSBFAC Sensor Head

Sensing Beam: infrared, 880nm

Sensing Range: see "box" at upper right

Response Time: 1 millisecond

Adjustments: GAIN control (15-turn clutched potentiometer) adjusts the sensitivity of the ac-coupled amplifier. Located on top of the sensor beneath a transparent LEXAN® window.

Indicators: LOCK LED lights whenever the AGC system has locked onto a signal. LOAD LED lights whenever the sensor's output circuit is energized. Both indicators located on top of the sensor beneath a transparent LEXAN® window.

Operating Temperature Range: -40 to +70°C (-40 to +158°F)

Construction: housing is molded from rugged VALOX® thermoplastic polyester for outstanding electrical and mechanical performance in demanding applications. The top window is of transparent LEXAN® polycarbonate. Hardware is stainless steel. When assembled to a compatible power block module, all parts are fully gasketed.

Standard OMNI-BEAM DC Power Blocks

Featuring Banner's exclusive **Bi-Modal™** output

Standard OMNI-BEAM dc power blocks provide regulated low voltage dc power to the sensor head and logic module (if one is used), with input of 10 to 30V dc. There are two infinite-life outputs, one for the load and the other for the alarm of the **D.A.T.A.** self-diagnostic system.

All models, except emitter-only types, have the unique **Bi-Modal™** output design (US patent no. 4982107) that offers either sinking (NPN) or sourcing (PNP) outputs, depending upon the polarity with which the two dc supply leads are connected. Outputs are protected from overload, shorted load, or low voltage conditions. Outputs automatically reset when the cause of the problem is cleared. Problems are identified by the **D.A.T.A.** light system.

All standard OMNI-BEAM power blocks are epoxy-encapsulated and rated for -40 to +70°C (-40 to +158°F). They feature limit switch style cross-hole design for front, back, or side mounting, plus a 30mm threaded hub for swivel bracket or through-hole mounting. Models include prewired cable or either style of quick-disconnect (QD) fitting. Assembled OMNI-BEAM Sensors are rated NEMA 1, 2, 3, 3S, 4, 12, and 13.

***NOTE: contact factory for availability of eurofast™ QD models.**



Specifications, Standard dc Power Blocks

Input: 10 to 30V dc at less than 80mA (exclusive of loads), 10% maximum ripple.

Output: two identical open-collector transistors, one for load and one for alarm. Both are configured to either sink (NPN) or source (PNP), depending upon the polarity of the power supply leads (see hookup drawings). 100mA maximum continuous, overload and short circuit protected (both outputs). *Off-state leakage current* less than 100 microamps. **NOTES:** Interface to TTL logic is not direct (contact factory). When the load and the OMNI-BEAM *do not* share a common power supply, load voltage *must* be ≤ the sensor supply voltage.

On-state Voltage Drop:

NPN outputs: <1.0V @10mA load, and <1.5V @100mA load.
PNP outputs: <1.0V @10mA load, and <1.5V @100mA load.

Models	Cable or Connector
OPBT2	Prewired 6-foot PVC-jacketed 4-conductor cable.
OPBT2QD	Integral standard 4-conductor quick-disconnect cable fitting. Requires <i>minifast™</i> cable model MBCC-412, sold separately (see page 16).
OPBT2QDH*	Integral 12mm 4-conductor quick-disconnect cable fitting. Requires <i>eurofast™</i> cable model MQDC-415, sold separately (see page 16).
<i>The following three power blocks are for use with emitters only (models OSBE and OSBEF). They contain no output circuitry.</i>	
OPBTE	Prewired 6-foot PVC-jacketed 2-conductor cable.
OPBTEQD	Integral standard 4-conductor quick-disconnect cable fitting. Requires <i>minifast™</i> cable model MBCC-412, sold separately (see page 16).
OPBTEQDH*	Integral 12mm 4-conductor quick-disconnect cable fitting. Requires <i>eurofast™</i> cable model MQDC-415, sold separately (see page 16).

Functional Schematic, Standard dc Power Blocks

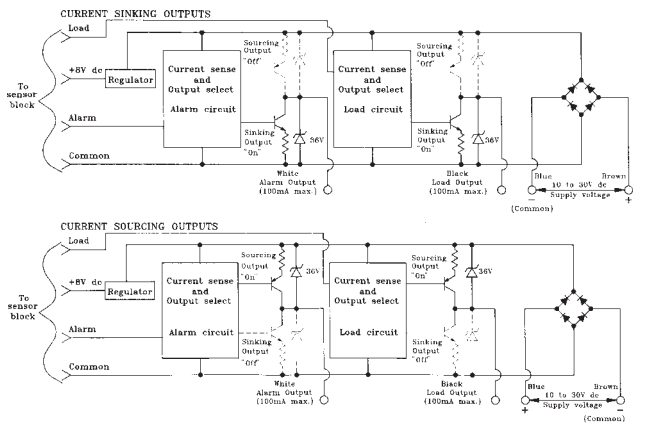

Hookup to a Simple Load, Sinking Outputs

The **Bi-Modal** output of Standard OMNI-BEAM dc power blocks is configured for current sinking (NPN) by connecting the **BROWN** supply wire to +V dc, and the **BLUE** wire to dc common.

Outputs sink 100mA, maximum.

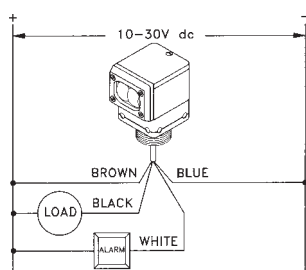

Hookup to PLC

Standard OMNI-BEAM dc power blocks interface directly to any type of programmable logic controller or computer dc input.

The current sinking configuration (NPN) is shown here. For the current sourcing configuration, simply reverse the polarity to the **BROWN** and **BLUE** power supply wires.

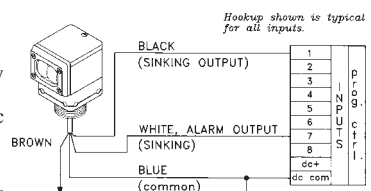

NOTE: "dc+" supply voltage to PLC input must be less than or equal to the OMNI-BEAM's supply voltage

Hookup to a Simple Load, Sourcing Outputs

The **Bi-Modal** output of Standard OMNI-BEAM dc power blocks is configured for current sourcing (PNP) by connecting the **BLUE** supply wire to +V dc, and the **BROWN** wire to dc common.

Each output sources up to 100mA.

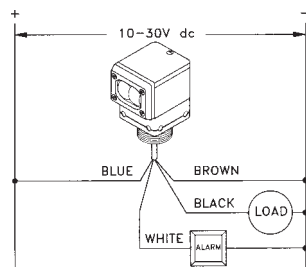

Hookup of Emitter

Standard OMNI-BEAM emitter sensor blocks (models OSBE and OSBEF) simply require supply voltage to operate.

Power blocks *without* output circuitry are available for powering emitters. However, power blocks *with* output circuitry may also be used to power emitters (output circuitry will go unused).

Hookup is without regard to polarity.

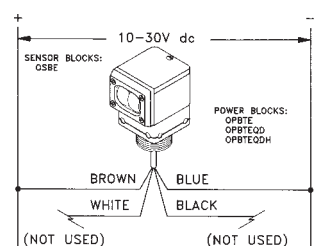

Standard OMNI-BEAM AC Power Blocks

Standard OMNI-BEAM ac power blocks are available for either 120V ac or 220/240V ac. They provide the regulated low-voltage dc power required to run the circuitry of the sensor head and logic module (if one is used). All models, except emitter-only types, have two solid-state output circuits, one for switching the load and the other for the alarm of the D.A.T.A. self-diagnostic system.

The LOAD output is an isolated 1/2-amp rated infinite-life solid-state relay. The alarm output is also a solid-state relay, rated at 0.2 amps, with one side of the contact tied internally to the "hot" side of the ac supply voltage. Both outputs have very low off-state leakage current for direct interfacing to programmable logic controllers (PLCs).



All Standard OMNI-BEAM power blocks are epoxy-encapsulated and rated for -40 to +70°C (-40 to +158°F). They feature limit-switch style cross-hole design for front, back, or side mounting, plus a 30mm threaded hub for swivel bracket or through-hole mounting. Models include prewired cable or quick-disconnect (QD) fitting. Assembled OMNI-BEAM Sensors are rated NEMA 1, 2, 3, 3S, 4, 12, & 13.

Specifications, Standard ac Power Blocks

Input:

120V models: 105 to 130V ac, 50/60Hz, 4 watts (excluding load)

220/240V models: 210 to 250V ac, 50/60Hz, 4 watts (excluding load)

Load Output:

500mA max. to 25°C, derated 1% per °C to 70°C; 7 amps max. inrush for 1 second or 20 amps max. for one cycle (non-repeating). On-state voltage drop less than 3V ac at full load. Off-state leakage current 100 microamps maximum.

Alarm Output:

200mA max. to 25°C, derated 2% per °C to 70°C; 2 amps max. inrush for 1 second or 3 amps max. for one cycle (non-repeating). On-state voltage drop less than 2.5V ac at full load. Off-state leakage current 100 microamps maximum.

Models	Input	Cable or Connector
OPBA2	105-130V ac	Prewired 6-foot PVC-jacketed
OPBB2	210-250V ac	5-conductor cable.
OPBA2QD	105-130V ac	Integral standard 5-conductor quick-disconnect cable fitting.
OPBB2QD	210-250V ac	Requires cable model MBCC-512, sold separately (page 16).
<i>The following four power blocks are for use with emitters only (models OSBE and OSBEF). They contain no output circuitry.</i>		
OPBAE	105-130V ac	Prewired 6-foot PVC-jacketed
OPBBE	210-250V ac	2-conductor cable.
OPBAEQD	105-130V ac	Integral standard 5-conductor quick-disconnect cable fitting.
OPBBEQD	210-250V ac	Requires cable model MBCC-512, sold separately (page 16).

Functional Schematic, Standard ac Power Blocks

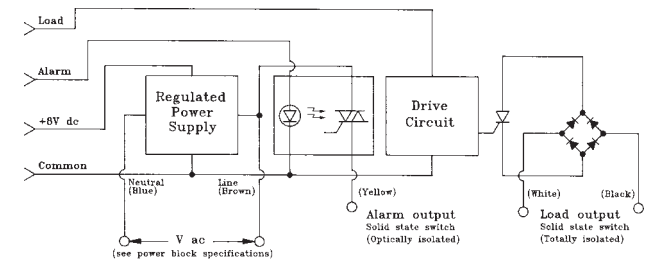

Hookup to a Simple Load

Standard OMNI-BEAM ac power blocks have two outputs. The LOAD output is isolated and can switch up to 0.5 amps. The ALARM output is tied internally to ac "hot" and can switch up to 0.2 amps.

The ALARM output may either connect to the system logic controller, or directly switch an alarm.

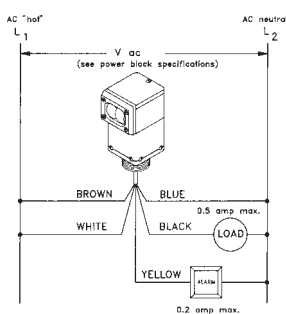

Hookup to PLC

Standard OMNI-BEAM ac power blocks are designed to directly interface to ac inputs of programmable logic controllers.

If the ALARM outputs of multiple OMNI-BEAMs are paralleled to a single input, then sensor block programming switch #2 must be in the "on" position (for normally open ALARM output).

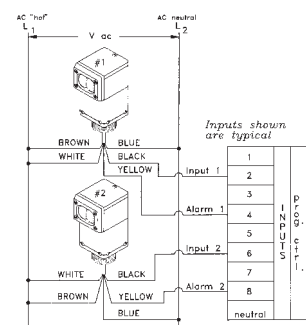

AC Sensors in Series

Standard OMNI-BEAM ac power blocks may be wired together in series with each other for "AND" logic.

The total voltage drop across the series will be the sum of the individual voltage drops across each power block (approx. 3 volts per block). With most loads, 10 or more power blocks may be wired in series.

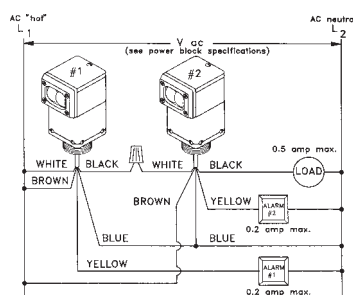

Hookup of Emitter

Standard OMNI-BEAM emitter sensor blocks (models OSBE and OSBEF) simply require supply voltage to operate.

Power blocks *without* output circuitry are available for powering emitters. However, power blocks *with* output circuitry may also be used to power emitters (output circuitry will go unused).

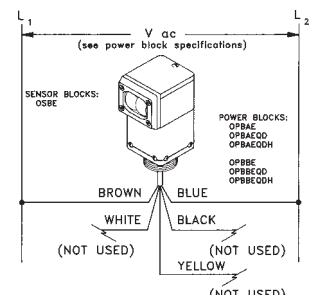

OMNI-BEAM Logic Modules

Standard OMNI-BEAM sensors easily accept the addition of timing logic when needed. Three multiple-function logic modules are available (see photo, upper right). Model OLM5 is programmable for ON-delay, OFF-delay, or ON/OFF-delay timing logic. Models OLM8 and OLM8M1 offer either ONE-SHOT or DELAYED ONE-SHOT functions. Programming of the logic function, the timing range, and the output state is done via a set of four switches located on the logic module.

Both logic modules feature 15-turn clutched potentiometers for accurate timing adjustments. The logic module simply slides into the sensor head housing and interconnects without wires (see photo, lower right). Timing adjustments are easily accessible at the top of the sensor head, and are protected by the sensor head's transparent, gasketed LEXAN® cover. Assembled sensors are rated NEMA 1, 2, 3, 3S, 4, 12, and 13.

OMNI-BEAM Logic Module Specifications

Operating Temperature: -40 to +70°C (-40 to +158°F)

Timing Adjustments: Two 15-turn clutched potentiometers with brass elements, accessible from outside at top of sensor block, beneath gasketed cover.

Timing Repeatability: Plus or minus 2% of timing range (maximum). Assumes conditions of constant temperature and power supply.

Useful Time Range: Useful range is from maximum time down to 10% of maximum all models. When timing potentiometer is set fully counterclockwise, time will be approximately 1% of maximum for models OLM5 and OLM8, and 2% of maximum for model OLM8M1.

Response Time: A disabled timing function adds no measurable sensing response time.

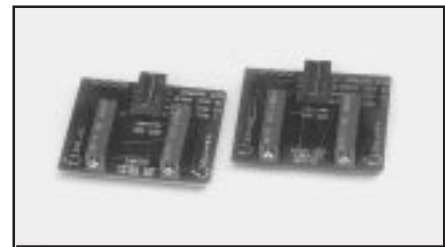

Plug-in timing logic modules are available for either delay or pulse timing functions.

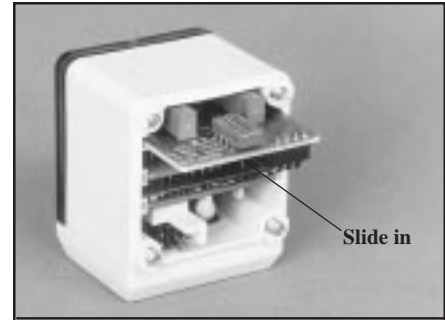

The logic module slides into the sensor head and interconnects without wires.

OLM5 Delay Timer Logic Module

Model **OLM5** is programmable for ON-DELAY or OFF-DELAY or ON/OFF DELAY timing functions. Each delay function may be independently adjusted and separately programmed for either a long or short adjustment range.

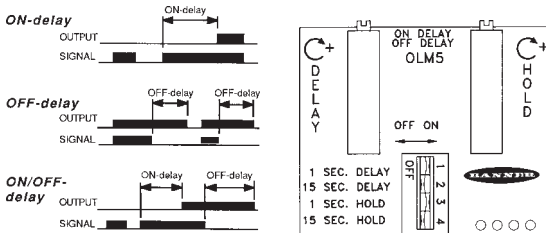

Timing Logic Function and Timing Range(s)	Switch Positions			
	#1	#2	#3	#4
ON-DELAY 1 second maximum	ON	OFF	OFF	OFF
ON-DELAY 15 seconds maximum	OFF	ON	OFF	OFF
OFF-DELAY 1 second maximum	OFF	OFF	ON	OFF
OFF DELAY 15 seconds maximum	OFF	OFF	OFF	ON
ON-DELAY & OFF-DELAY 1 second maximum	ON	OFF	ON	OFF
ON-DELAY & OFF-DELAY 15 seconds maximum	ON	OFF	OFF	ON
ON-DELAY & OFF-DELAY 15 seconds maximum	OFF	ON	ON	OFF
ON-DELAY & OFF-DELAY 15 seconds maximum	OFF	ON	OFF	ON

NOTE 1: if both ranges of either delay function are selected (i.e., if both 1 second and 15 second switches are "on"), the delay time range becomes 16 seconds, maximum.

NOTE 2: with switches #1 and #2 "off" (no ON-DELAY programmed), ON-DELAY is adjustable from "negligible" up to 100 milliseconds, maximum.

NOTE 3: with switches #3 and #4 "off" (no OFF-DELAY programmed), OFF-DELAY is adjustable from "negligible" up to 100 milliseconds, maximum.

OLM8 Pulse Timer Logic Module

Models **OLM8** and **OLM8M1** are programmable for either a ONE-SHOT ("single-shot") pulse timer or a DELAYED ONE-SHOT logic timer. DELAY and PULSE times may be independently adjusted and separately programmed for either a long or short adjustment range. OLM8M1 maximum times are 1/10 those of the OLM8.

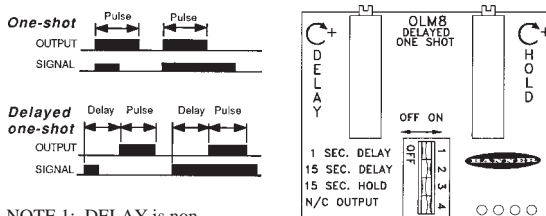

Logic Function and Timing Ranges: models OLM8 and OLM8M1*	Switch Positions			
	#1	#2	#3	#4
ONE-SHOT 1 (.1) second max. pulse	OFF	OFF	OFF	----
ONE-SHOT 15 (1.5) seconds max. pulse	OFF	OFF	ON	----
DELAYED ONE-SHOT 1 (.1) second max. delay	ON	OFF	OFF	----
DELAYED ONE-SHOT 15 (1.5) seconds max. delay	OFF	ON	OFF	----
DELAYED ONE-SHOT 1 (.1) second max. delay	ON	OFF	ON	----
DELAYED ONE-SHOT 15 (1.5) seconds max. delay	OFF	ON	ON	----

For normally open outputs (outputs conduct during pulse time) _____ OFF
 For normally closed outputs (outputs open during pulse time) _____ ON
 *Timing specifications for model OLM8M1 are printed in italics.

NOTE 1: DELAY is non-retriggerable. PULSE is retriggerable if the DELAY time is less than the ONE-SHOT pulse time.

NOTE 2: if both ranges of the delay function are selected (i.e., if both 1 second and 15 second switches are "on"), the delay time range becomes 16 (1.6*) seconds, maximum.

NOTE 3: with switches #1 and #2 "off" (no DELAY programmed), DELAY is adjustable from "negligible" up to 10 (4.5*) milliseconds, maximum.

OMNI-BEAM Accessories

Quick-disconnect Cables

Quick-disconnect cables are available in two styles: *minifast*TM SJT-type and *eurofast*TM ST-style* (standard dc power blocks only). They are ideal for use in situations where it is desirable to be able to substitute or replace the sensor and/or cabling.

Standard OMNI-BEAM dc power blocks use 4-conductor cables. **Standard ac models** use cables with 5 conductors. It is impossible to plug either an ac or a dc sensor into the wrong cable.

Minifast cables are 12 feet long. Eurofast cables are 15 feet long. All quick-disconnect cables have 22 AWG conductors. Dimensional information is given in the drawings below.

*Contact the factory for availability of *eurofast*TM QD models

Power Block Model	Use Cable Model
OPBT2QD OPBTEQD	MBCC-412
OPBT2QDH OPBTEQDH	MQDC-415*
OPBA2QD OPBAEQD OPBB2QD OPBBEQD	MBCC-512

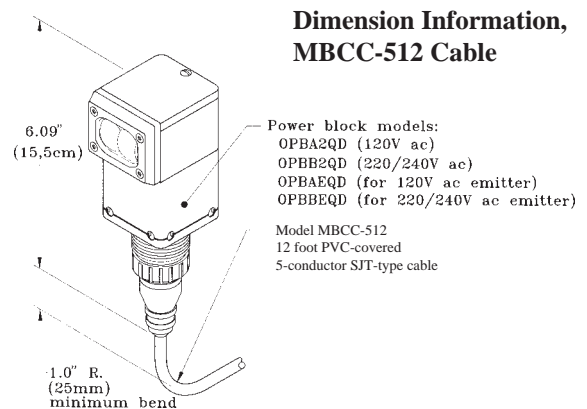
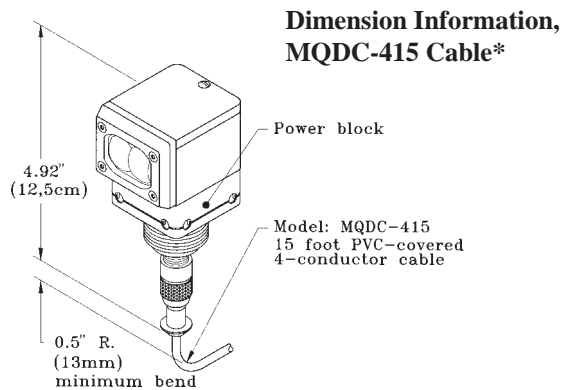
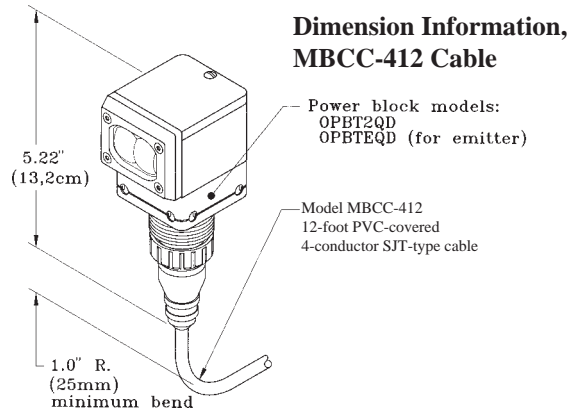

SMB30MM 2-axis Mounting Bracket

Accessory mounting bracket model SMB30MM has curved mounting slots for versatility in mounting and orientation. The OMNI-BEAM mounts to the bracket by its threaded base, using a jam nut and lockwasher (supplied). The curved mounting slots have clearance for 1/4-inch screws. Bracket material is 11-gauge stainless steel.

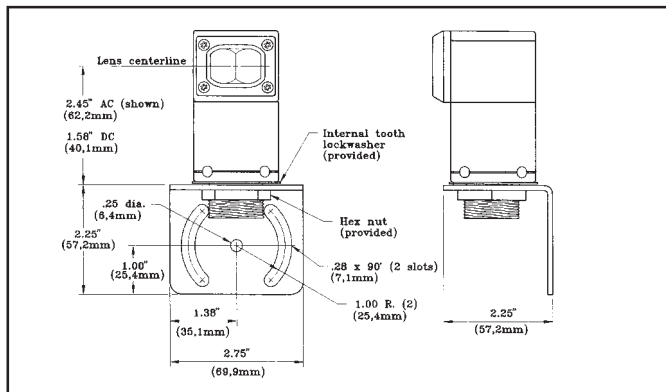

SMB30SM Swivel Mounting Bracket

Accessory mounting bracket model SMB30SM is a swivel mount bracket whose swivel ball locks in place when its two clamping bolts are tightened. Bracket material is black VALOX®. Hardware is stainless steel, and mounting bolts are included. This bracket may be used with OMNI-BEAMS and other sensors having M30 x 1,5 threads.

