

# T Series Subminiature Rocker Switches

## Features/Benefits

- Compact size—small footprint
- Single and double pole models
- PC and panel mounting options available
- RoHS compliant

## Typical Applications

- Telecommunications
- Instrumentation
- Medical Equipment

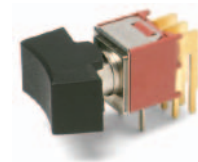

Models Available

## Specifications

CONTACT RATING: Q contact material (TX01 models): 3 AMPS @ 120 V AC or 28 V DC. All other models: 2 AMPS @ 120 V AC or 28 V DC. See page G-50 for additional ratings.

ELECTRICAL LIFE: TX01 models: 60,000 make-and-break cycles at full load. All other models: 30,000 cycles.

CONTACT RESISTANCE: Below 20 m Ω typ. initial @ 2–4 V DC, 100 mA, for both silver and gold plated contacts.

INSULATION RESISTANCE: 10<sup>9</sup> Ω min.

DIELECTRIC STRENGTH: 1000 Vrms min. @ sea level.

OPERATING TEMPERATURE: –30°C to 85°C.

SOLDERABILITY: Per MIL-STD-202F method 208D, or EIA RS-186E method 9 (1 hour steam aging).

**NOTE:** Any models supplied with B, G, P, Q or R contact material are RoHS compliant.

**NOTE:** Specifications and materials listed above are for switches with standard options. For information on specific and custom switches, consult Customer Service Center.

## Materials

CASE: Glass filled nylon 6/6, flame retardant, heat stabilized or diallyl phthalate (DAP), (UL 94V-0) or glass filled nylon 4/6, flame retardant, heat stabilized.

ACTUATOR: Nylon, black standard.

BUSHING: Brass, nickel plated.

HOUSING: Stainless steel.

SWITCH SUPPORT: Brass, matte-tin plated.

MOUNTING BRACKET: Stainless steel.

END CONTACTS: B contact material: Copper alloy, with gold plate over nickel plate. Q contact material: Coin silver, silver plated. See page G-50 for additional contact materials.

CENTER CONTACTS & TERMINALS: B contact material: Copper alloy, with gold plate over nickel plate. Q contact material: Copper alloy, silver plated. See page G-53 for additional contact materials.

TERMINAL SEAL: Epoxy.

HARDWARE: Nut, Screws & Lockwasher: Stainless steel. Standoff: Nylon standard.

## Build-A-Switch

To order, simply select desired option from each category and place in the appropriate box. Available options are shown and described on pages G-47 through G-51. For additional options not shown in catalog, consult Customer Service Center. All models have epoxy terminal seal and are compatible with all “bottom-wash” PCB cleaning methods.

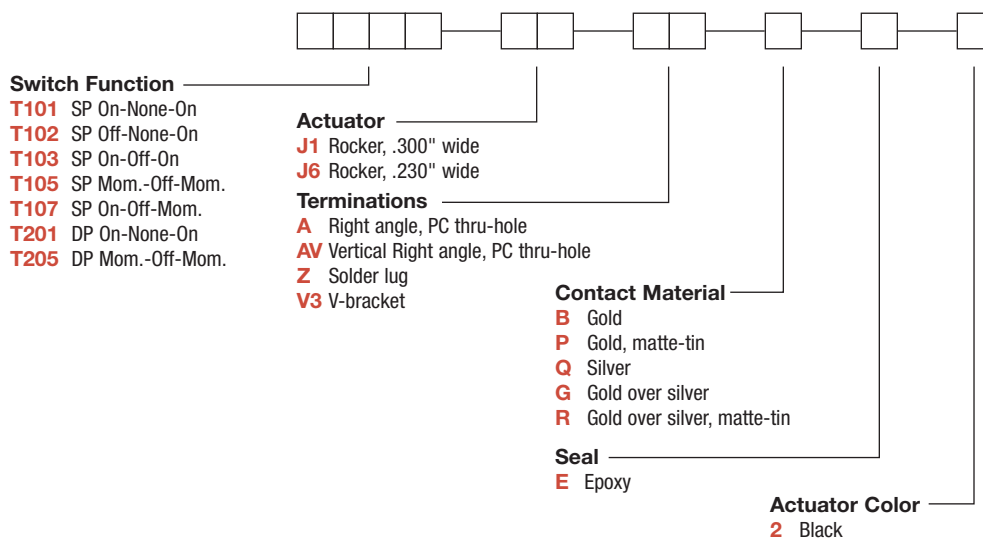

Rocker



G

**C&K**

Dimensions are shown: Inches (mm)  
Specifications and dimensions subject to change

# T Series Subminiature Rocker Switches

SWITCH FUNCTION

ACTUATOR COLOR



NO. POLES	MODEL NO.	SWITCH FUNCTION			CONNECTED TERMINALS			SCHEMATIC
		POS. 1	POS. 2	POS. 3	POS. 1	POS. 2	POS. 3	
SP	<b>T101</b>	ON	NONE	ON	2-3	N/A	2-1	
	<b>T103</b>	ON	OFF	ON		OPEN		
	<b>T105</b>	MOM.	OFF	MOM.				
	<b>T107</b>	ON	OFF	MOM.				
	<b>T102</b>	OFF	NONE	ON				

**SPDT**

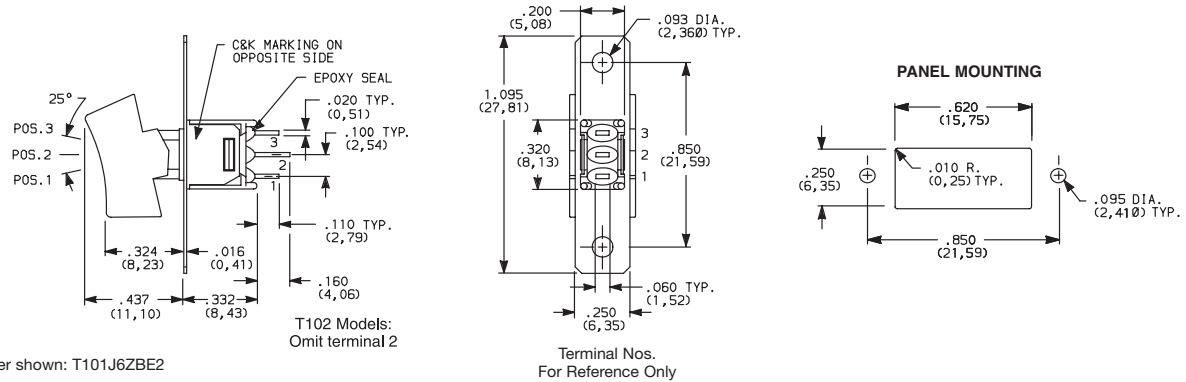

DP	<b>T201</b>	ON	NONE	ON	2-3,5-6	N/A	2-1,5-4	
	<b>T205</b>	MOM.	OFF	MOM.		OPEN		

**DPDT**

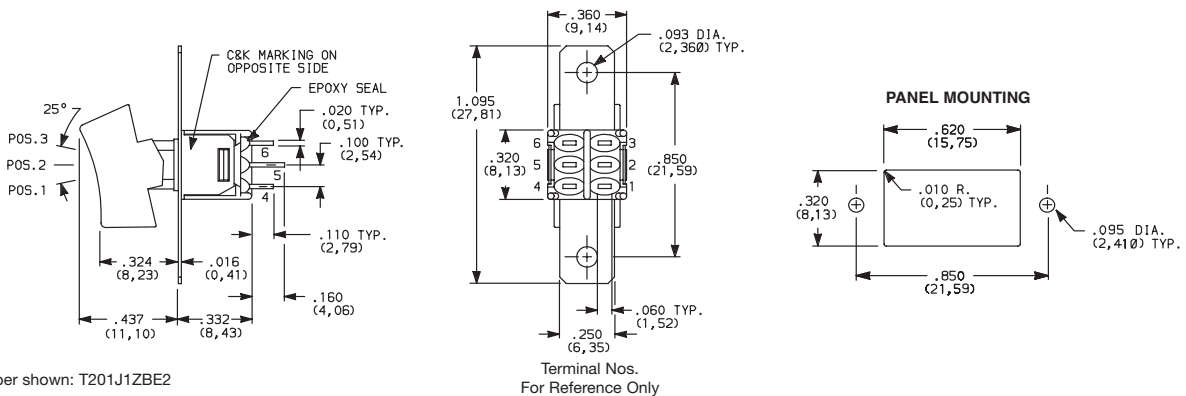

MOM. = Momentary

All models with all options when ordered with G, Q or R contact material.



Dimensions are shown: Inches (mm)  
Specifications and dimensions subject to change

www.ck-components.com



# T Series Subminiature Rocker Switches

## ACTUATOR

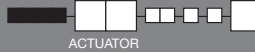

### J1 ROCKER, .300 WIDE

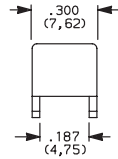
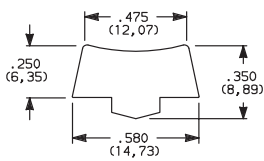

#### PANEL MOUNTING

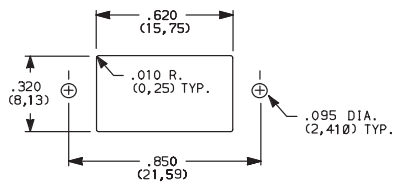

OPTION CODE	ACTUATOR COLOR
<b>2</b>	<b>BLACK</b>

Actuators available separately, see page G 51-G53. Finish: Matte. Other colors, custom actuator markings and legends available, consult Customer Service Center.

Standard with all models except T10X with A terminations.

### J6 ROCKER, .230 WIDE

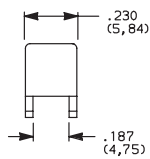
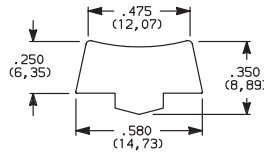

#### PANEL MOUNTING

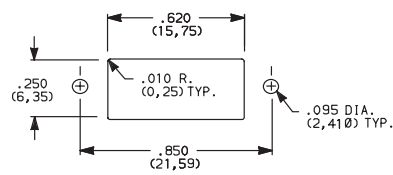

Standard with T10X model with A terminations.

## TERMINATIONS



### Z SOLDER LUG

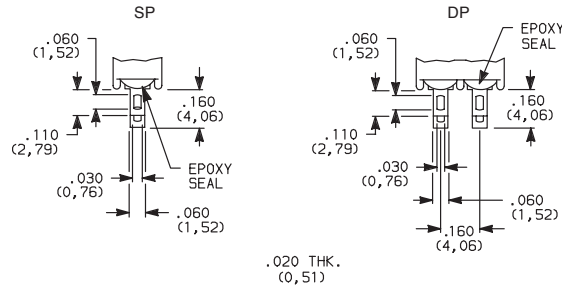

#### SP and DP

Not available with P or R contact material.

### A RIGHT ANGLE, PC THRU-HOLE

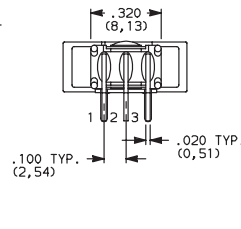
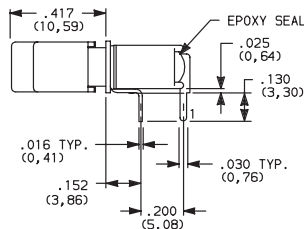
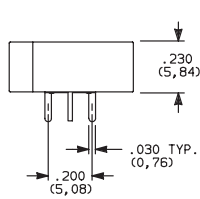

#### PC MOUNTING

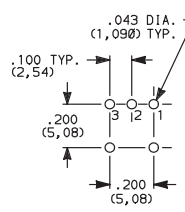

**T101J6ABE2**  
Horizontal Actuation  
**SPDT**

Not available with T102 model. J6 actuator standard only on T10X models with A terminations.



Third Angle  
Projection

Dimensions are shown: Inches (mm)

Specifications and dimensions subject to change

Rocker



**C&K**

# T Series Subminiature Rocker Switches

## TERMINATIONS

### A RIGHT ANGLE, PC THRU-HOLE



**T201J1ABE2**  
Horizontal Actuation  
**DPDT**

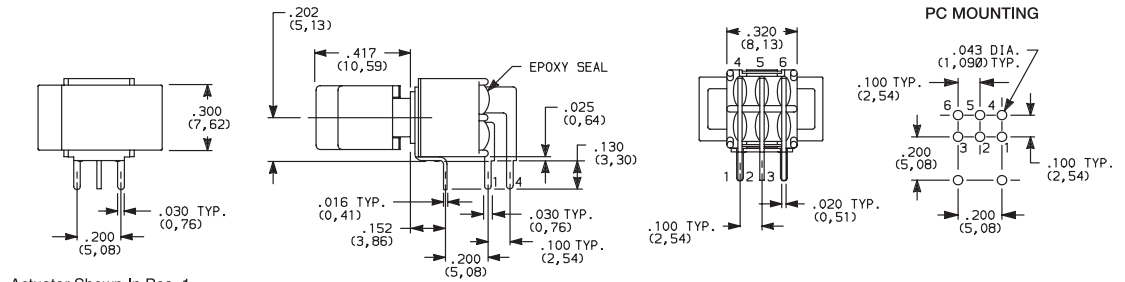

Actuator Shown In Pos. 1

### AV VERTICAL RIGHT ANGLE, PC THRU-HOLE



**T101J1AVBE2**  
Vertical Actuation  
**SPDT**

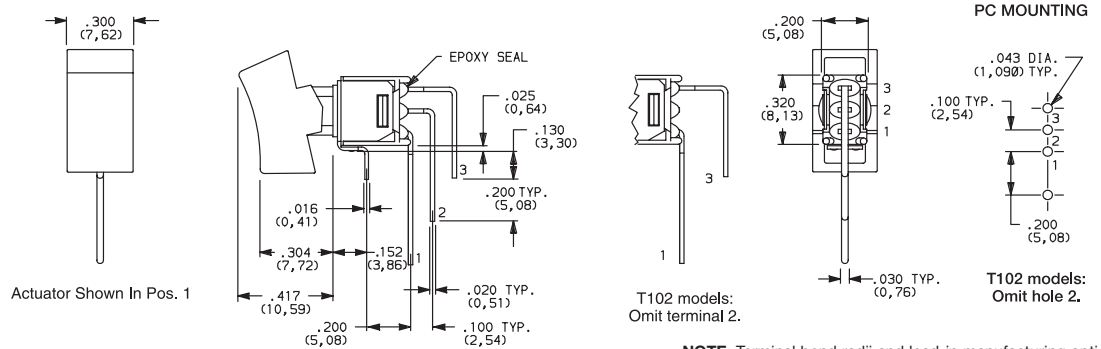

Actuator Shown In Pos. 1

T102 models:  
Omit terminal 2.

T102 models:  
Omit hole 2.

**NOTE:** Terminal bend radii and lead-in manufacturing option.

### AV VERTICAL RIGHT ANGLE, PC THRU-HOLE



**T201J1AVBE2**  
Vertical Actuation  
**DPDT**

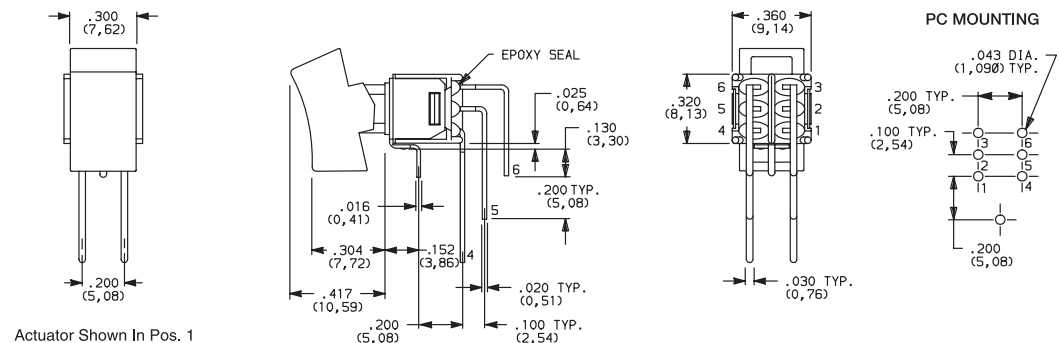

Actuator Shown In Pos. 1

**NOTE:** Terminal bend radii and lead-in manufacturing option.

### V3 VERTICAL MOUNT, V-BRACKET



**T101J1V3BE2**  
**SPDT**

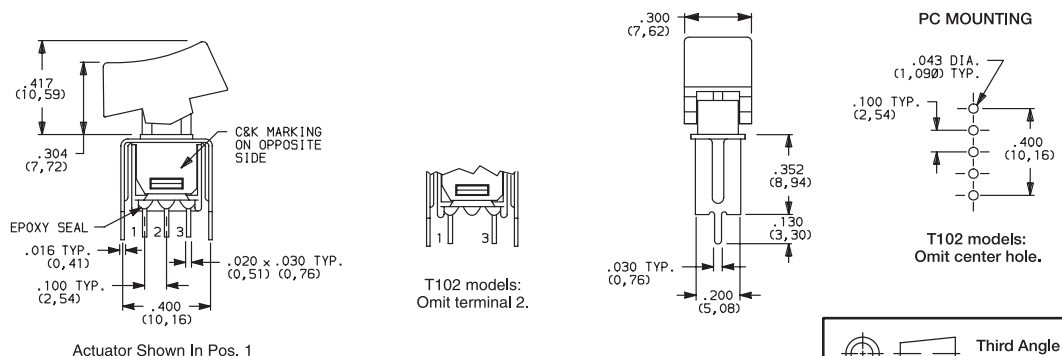

C&K MARKING ON OPPOSITE SIDE

T102 models:  
Omit terminal 2.

T102 models:  
Omit center hole.

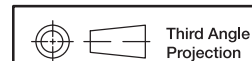

Third Angle Projection  
Dimensions are shown: Inches (mm)  
Specifications and dimensions subject to change



# T Series Subminiature Rocker Switches

## TERMINATIONS

### V3 VERTICAL MOUNT, V-BRACKET

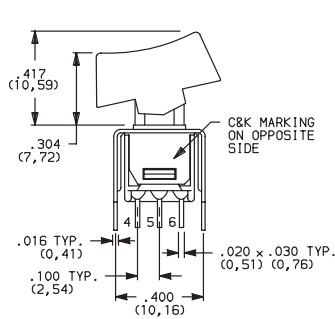

Actuator Shown In Pos. 1

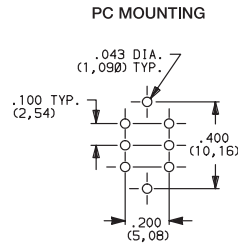
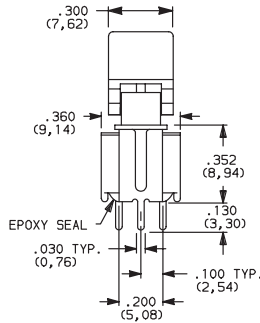

T201J1V3BE2  
DPDT

## CONTACT MATERIAL

OPTION CODE	CONTACT MATERIAL	TERMINAL PLATING	RATINGS	
<b>B</b>	GOLD <sup>3</sup>	GOLD <sup>1</sup>	LOW LEVEL/ DRY CIRCUIT	0.4 VA MAX. @ 20 V AC OR DC MAX.
<b>P</b>		MATTE-TIN <sup>6</sup>		
<b>Q</b>	SILVER <sup>4,5</sup>	SILVER <sup>5</sup>	POWER	TX01 MODELS: 3 AMPS @ 120 V AC OR 28 V DC. ALL OTHER MODELS: 2 AMPS @ 120 V AC OR 28 V DC.
<b>G</b>	GOLD OVER SILVER <sup>2,3</sup>	GOLD <sup>3</sup>	LOW LEVEL/DRY CIRCUIT OR POWER	TX01 MODELS: 0.4 VA MAX @ 20 V AC OR DC MAX. OR 3 AMPS @ 120 V AC OR 28 V DC. ALL OTHER MODELS: 0.4 VA MAX @ 20 V AC OR DC MAX. OR 2 AMPS @ 120 V AC OR 28 V DC.
<b>R</b>		MATTE-TIN <sup>6</sup>		

\* Note: See Technical Data section of this catalog for RoHS compliant and compatible definitions and specifications.

- 1 CONTACTS & TERMINALS: Copper alloy, with gold plate over nickel plate.
- 2 END CONTACTS: Coin silver, with gold plate over nickel plate.
- 3 CENTER CONTACTS & ALL TERMINALS: Copper alloy, with gold plate over nickel plate.
- 4 END CONTACTS: Coin silver, silver plated.
- 5 CENTER CONTACT & ALL TERMINALS: Copper alloy, silver plated.
- 6 TERMINALS: Copper alloy, with matte-tin over nickel plate.

**NOTE:** Any models supplied with B, G, P, Q & R contact material are RoHS compliant.

All models with all options when ordered with G, Q, or R contact material.

B contact material standard with A, AV, V3 terminations.

Q contact material standard with C & Z terminations.

P & R contact materials not available with Z terminations.

## SEAL

### E EPOXY SEAL

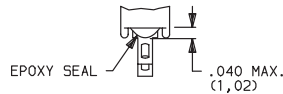

Rocker



G

**C&K**



Third Angle  
Projection

Dimensions are shown: Inches (mm)  
Specifications and dimensions subject to change

# T Series Subminiature Rocker Switches

## AVAILABLE HARDWARE

Panel mounting hardware for rocker and lever handle switches is available separately. Mounting hardware consists of two screws, two nuts, two standoffs and two lockwashers per switch, and is available for panel thicknesses of 1/16, 3/32 and 1/8 inch. See part numbers below.

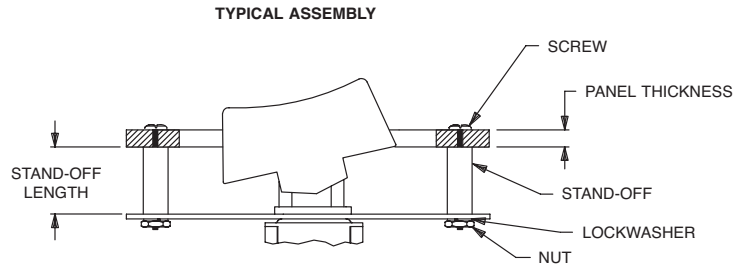

PART NO.	PANEL THK.	STANDOFF LENGTH
761101000	1/16 IN. (1,59)	.295 (7,49)
761102000	3/32 IN. (2,38)	.264 (6,71)
761103000	1/8 IN. (3,18)	.233 (5,92)

**NOTE:** Additional nuts, screws and lockwashers available separately, see Technical Data section of this catalog.

### J1 Actuator



PART NO.  
468002263 BLACK

Material: Nylon  
Finish: Matte

### J6 Actuator

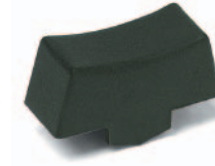

PART NO.  
468102263 BLACK

Material: Nylon  
Finish: Matte

**NOTE:** Other colors, custom actuator markings and legends available, consult Customer Service Center.

