

Multi-Interlock Mark II Connector
マルチインターロックコネクタ (MIC)

Contents

First 16 pages following this top sheet : English version
Next 15 pages : Japanese version

When only one of above versions is supplied to customers, this top sheet shall be attached.

目次

このシートに続く最初の 16 ページ : 英語版
次の 15 ページ : 日本語版

カスタマーに英語または日本語版の片方のみを提出する場合は、このトップシートが必ず添付されなければならない。

Revision Record (改訂記録)

Revision Letter (改訂記号)	EC number (改訂記録番号)	Date (日付)
E1	FJ00-1742-99	19 OCT 1999

Outline of the latest revision (最新改訂の概要)

Combine two language versions into one document. No change was made on product specification.

2ヶ国語の文書を一括管理とした。仕様内容に変更なし。

108-5099

NUMBER

Customer Release

AMP SECURITY CLASSIFICATION

PRINT DIST

108-5099

Product Specification
Multi-interlock Connector

1. Scope:

This specification covers general requirements and test methods for multi-interlock connectors of the following part numbers, exclusively used for wire-to-wire transit termination.

2. Applicable Product Part Numbers:

2.1 Contacts:

2.1.1 Receptacle Contacts: 170177, 170286, 170307, 170189, 170487, 170289

2.1.2 Tab Contacts: 170221, 170308, 170222, 170459

2.2 Housings:

Number of Positions	Plug Housing	Cap Housing	Cap Housing *
5	172026	172044	172389
7	172025	172043	172390
9	171892	172042 172096 (w/Flange)	172391
11	172024	172041	172392
13	171358	171725	172393
17	171354	171827 171828 (w/Flange)	172395
21	171364	171829 171830 (w/Flange)	--
15	172388	--	172394

3. Definitions of Terms:

*Panel lock type

The terms used in this specification shall be defined as follows.

3.1 Contacts:

Electrically conductive metallic members used for termination in connector cavities. Receptacle contacts and tab contacts are available.

3.2 Housing:

Insulating material blocks with cavities into which contacts are encapsulated. Plug housing accommodates receptacle contacts and cap housing accommodates tab contacts.

DR *[Signature]* 12-7-79
CHK *[Signature]* 12-7-79
APP *[Signature]* 12-7-79



AMP (Japan), Ltd.
TOKYO, JAPAN

LOC J A NO 108-5099 REV E

SHEET NAME

Product Specification

1 OF 16

Multi-interlock Connector

REVISION RECORD

DR CHK DATE

- 3.3 Connector:
 A connector assembly consists of housing block filled with wire crimped contacts in its full cavities. There are two types of connector assembly available, a plug connector filled with receptacle contacts and a cap connector filled with tab contacts.
4. Material and Finish:
- 4.1 Contacts:
 Contacts are fabricated from pre-tinned brass strip, conforming to ASTM B 36 Copper Alloy 260.
- 4.2 Housing:
 Housing shall be made of molded NYLON* resin.
- 5 Product Feature, Construction and Dimensions:
- 5.1 Contacts:
 Product feature, construction and dimensions of contacts shall be conforming to applicable customer product drawing(s). All tab contacts shall be capable to mate with all receptacle contacts regardless of wire sizes applied.
- 5.2 Housing:
 Product feature, construction and dimensions of housings shall be conforming to applicable customer product drawing(s). Housings shall have a polarizing device to prevent mismatching and locking device for retention of secure mating.
6. Applicable Service Range:
- 6.1 Temperature Rating:
 The temperature rating of connector assembly shall be within the range of -30 to 105°C. This totally includes temperature rising of both the effects of environmental condition and energized load.
- 6.2 Applicable Wire Range and Wire Crimp Combination:

Contact No.	Applicable Wire Range and Wire Crimp Combination	Insulation Diameter
170177 170189 170221 170222 170286 170289	0.5-2.27mm ² (AWG #20-#14) one wire, or two-wire combination of 0.5+0.5mm, 0.5+0.85mm ² (two #20 wires or one #20 wire plus one #18 wire)	2.1 - 3.4 mm
170307 170308 170459 170487	0.3-0.89mm ² (AWG #22-#18) one wire	1.5 - 2.6 mm

7. Performance Requirements and Test Methods:
 When tested in accordance with the test methods specified in Para. 7.2, and test sequence specified in Para. 7.3, product performance shall meet the requirements specified in Table 1.

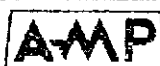
SHEET				AMP (Japan), Ltd. TOKYO, JAPAN	
2 OF 16				LOC	NO
		J	A	108-5099	E
NAME Product Specification					
Multi-interlock Connector					

Summary of Performance Requirements, Test Method and Procedure:				
Test Items	Para-graph No.	Performance Requirements of Contacts Initial Measurement	Performance Requirements of Connector Ass'y	
			Initial	After Environmental Testing
Appearance (Confirmation of Products)	7.2.1	Products must be free from defects such as cracks, blister, damage, loose of parts, rust and fusion that are detrimental to connector functions.		
Insertion Force: (Contacts and Connector)	7.2.2	2.9 - 8.3 N (0.3 - 0.85 kgf)	5-Pos.	59N (6.0 kgf) Max.
			7-Pos.	74N (7.5 kgf) "
			9-Pos.	88N (9.0 kgf) "
			11-Pos.	103N (10.5 kgf) "
			13-Pos.	123N (12.5 kgf) "
			17-Pos.	157N (16.0 kgf) "
			21-Pos.	186N (19.0 kgf) "
			22-Pos.	(Refer to 9-Pos. & 13-Pos.)
Extraction Force: (Contacts and Connector)	7.2.3	1.5 - 8.3 N (0.15 - 0.85 kgf)	5-Pos.	6.9 - 59 N (0.7 - 6.0 kgf)
			7-Pos.	9.8 - 74 N (1.0 - 7.5 kgf)
			9-Pos.	12.7 - 88 N (1.3 - 9.0 kgf)
			11-Pos.	15.7 - 103 N (1.6 - 10.5 kgf)
			13-Pos.	19.6 - 123 N (2.0 - 12.5 kgf)
			17-Pos.	24.5 - 157 N (2.5 - 16.0 kgf)
			21-Pos.	31.4 - 186 N (3.2 - 19.0 kgf)
			22-Pos.	(Refer to 9-Pos. & 13-Pos.)
Termination Resistance: (Low Level)	7.2.4	3.0 mΩ Max.	3.0 mΩ Max.	3.0 mΩ Max.
Termination Resistance: (Rated Current)	7.2.5	3mV/A Max.	3.0 mV/A Max.	3.0 mV/A Max.
Handling Touch of Insertion/Extraction of Contact	7.2.6	No obstruction must be felt during insertion-extraction working of contacts at assembly.		
Insulation Resistance:	7.2.7	—————	100MΩ (Max.)	
Dielectric Strength	7.2.8	—————	No abnormalities shall be evident after testing at 1,800V AC for 1 minute.	
Current Leakage:	7.2.9	—————	3 mA Max.	
Contact Retention Force:	7.2.10	—————	58.8N(6.0kgf) Max.	
Crimp Tensile Strength:	7.2.11	0.3mm ²	49N(5.0kgf) Min.	
		0.5mm ²	88N(9.0kgf) Min.	
		0.85mm ²	127N(13.0kgf) Min.	
		1.25mm ²	177N(18.0kgf) Min.	
		2.0mm ²	265N(27.0kgf) Min.	
Housing Retention Force	7.2.12	—————	98N(10.0kgf) Min.	

108-5099
 NUMBER
 Customer Release
 AMP SECURITY CLASSIFICATION

Table 1 (to be continued)

SHEET



AMP (Japan), Ltd.
TOKYO, JAPAN

3 OF 16

LOC	NO	REV
J A	108-5099	E 1

NAME Product Specification
Multi-interlock Connector

Summary of Performance Requirements, Test Method and Procedure: (continued)				
108-5099 NUMBER	Test Item	Para-graph No.	Performance Requirements of Contacts Initial Measurement	Performance Requirements of Connector Ass'y
				Initial
Customer Release AMP SECURITY CLASSIFICATION	Current Cycling	7.2.13	//	Connector sample must meet performance requirements after durability and environmental testing, specified in Table 5.
	Temperature Rising	7.2.14		
	Repeated Insertion/Extraction Force	7.2.15		
	"Kojiri" Resistibility	7.2.16		
	Heat Resistibility	7.2.17		
	Cold Resistibility	7.2.18		
	Thermal Shock	7.2.19		
	Humidity (Steady State)	7.2.20		
	Salt Spray	7.2.21		
	Dust Bombardment	7.2.22		
	Icing	7.2.23		
	Vibration(High Frequency)	7.2.24		
	Physical Shock (I)	7.2.25		
	Physical Shock (II)	7.2.26		
Current, Overload	7.2.27	Sample must not be inflamed.		
Panel Locking Retention	7.2.28	196N(20Kgf)Min.		
Contact Loading Force	7.2.29	14.7N(1.5Kgf)Max.		
Table 1 (end)				
7.2	Test Methods:			
7.2.1	Appearance: Visually and tactually inspect product samples for evidence of abnormalities such as cracks, blister, damage, loose of parts, rust and fusing that are detrimental to connector functions.			
7.2.2	Insertion Force of Contact and Connector: Secure contact or connector sample on the head of tensile testing machine, and operate the head to insert product sample into a counterpart sample by applying an axial load to travel with the speed at a rate of 100mm a minute constantly, with the locking device of connector set in effect, when applicable.			
7.2.3	Extraction Force of Contact and Connector: Secure contact or connector sample on the head of tensile testing machine, and operate the head to extract sample product from mated counterpart by applying an axial load with the speed to travel at a rate of 100mm a minute constantly, without the locking device of connector set in effect, when applicable.			

SHEET			AMP (Japan), Ltd. TOKYO, JAPAN	
4 OF 16	LOC J A	No	108-5099	REV E 1
NAME Product Specification				
Multi-interlock Connector				

7.2.4 Termination Resistance (Low Level):

Termination resistance of sample contact or connector is obtained by measuring millivolt drop of the test circuit across the specified probing points (Y-Y') on the wires 75mm apart from the crimped portion, by applying closed circuit current of 50mA maximum at open circuit voltage of 50mV DC maximum flowing through the test circuit, where sample contact or connector is terminated as shown in Fig. 1, below. Low level resistance is calculated after deducting the resistance of 150mm long wire. Measurement shall be done on each wire circuit independently.

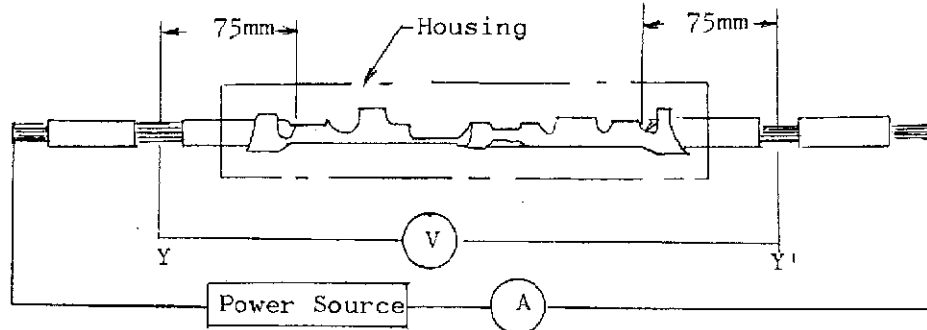

Fig. 1

7.2.5 Termination Resistance (Rated Current):

Termination resistance of mated pair of contacts or connector is obtained by measuring voltage drop of the test circuit across the specified probing points (Y-Y') on the wires 75mm apart from the crimped portion by applying closed circuit current of 1A at open circuit voltage of 12V DC flowing through the test circuit. Measurement shall be done after temperature rising of the circuit becomes stabilized. Termination resistance is calculated after deducting the resistance of 150mm long wire.

7.2.6 Handling Touch of Contact at Insertion and Extraction:

Check handling touch of contact for whether obstruction is felt during assembly operation, by manually inserting and extracting the parts repeatedly, as if handling in production.

7.2.7 Insulation Resistance:

Insulation resistance of mated pair of connector assemblies shall be measured by applying test potential of 500V DC RMS between adjacent contacts, and between contacts and the ground, after contacts are wired to form circuit in the diagrams shown below.

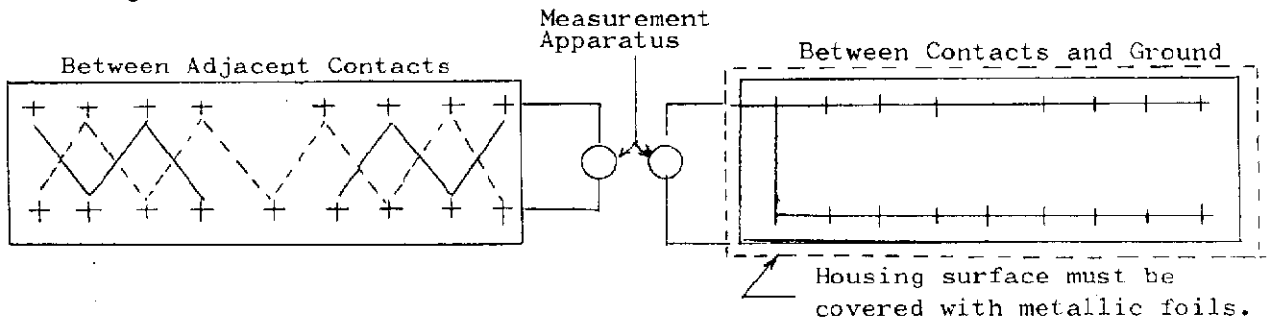

Fig. 2

SHEET	AMP		AMP (Japan), Ltd. TOKYO, JAPAN	
5 OF 16	LOC J	A	NO 108-5099	REV E1
NAME Product Specification				
Multi-interlock onnector				

7.2.8 Dielectric Strength:

Dielectric strength of mated pair of connector assemblies shall be measured by applying test potential of 1,800V AC in commercial frequency for 1 minute between adjacent contacts and between the contacts and the ground, terminated to form the circuits as shown in Fig. 2.

7.2.9 Current Leakage:

After being exposed under temperature-humidity conditioning in the test chamber for 1 hour where temperature of $60 \pm 5^{\circ}\text{C}$ with relative humidity of 90-95% is maintained, the mated connector assemblies shall be energized with 12V DC between the adjacent contacts terminated to form the circuit as shown in Fig. 3 below.

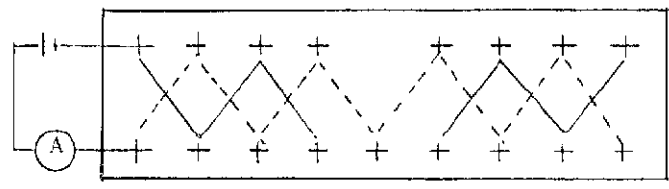

Fig. 3

7.2.10 Contact Retention Force:

After crimping on a 0.85mm^2 , 150mm long wire, a contact shall be inserted in housing position. The connector assembly shall be secured on the head of tensile testing machine and apply an axial pull off load to the contact by operating the head to travel with the speed at a rate of 100mm a minute. Contact retention force is determined when the contact is dislodged from the housing position.

7.2.11 Crimp Tensile Strength:

A 100mm long wire crimped contact shall be secured on the head of tensile testing machine, and apply an axial load to pull off the wire from the wire crimp by operating the head to travel with the speed at a rate of 100mm a minute. Crimp tensile strength is determined when the wire is pulled off from the wire crimp or wire is broken off.

7.2.12 Housing Retention Force:

Contact loaded connector assemblies shall be mated with their locking devices set in effect, which shall be then secured on the head of tensile testing machine. Housing retention force is tested by applying an axial load to unmate the connector assemblies with the speed at a rate of 100mm a minute. The force is determined when the assemblies are separated with the locking device resulted to be broken or to loose off by the test.

SHEET			AMP (Japan), Ltd. TOKYO, JAPAN	
6 OF 16	LOC	NO	REV	
	J	A	108-5099	E 1
NAME Product Specification				
Multi-interlock Connector				

7.2.13 Current Cycling:

Contact loaded and mated pair of connector assemblies shall be tested for current cycling by applying test current calculated by the data specified in Table 2. (For calculation of current intensity, see note below.) On the centering 4 positions, apply basic value of intensity respectively, and remaining each position shall be energized with intensity one half of the basic value. The test consists of 200 cycles of energizing for 45 minutes with 15-minute unloaded intervals taken between them. The test shall be conducted in a draft-free chamber. After test conditioning, connector samples shall be tested for durability and environmental performance in accordance with the test sequence specified in Table 5.

Wire Size	Basic Current Value (A) DC	Number of Positions	Reduction Coefficient
mm ²	(AWG)		
0.5	(#20)	1	1
0.85	(#18)	2 - 3	0.75
1.25	(#16)	4 - 5	0.6
2.0	(#14)	6 - 8	0.55
		9 - 12	0.5
		13 & Over	0.4

Table 2

Note: The current intensity is dependent upon wire size and the number of positions, due to the reasons of current withstanding capacity and efficiency of dissipation of heat, which is generated inside the connector during operation. To obtain the sum, first, select basic value from the left columns according to the wire size used. Then, have it multiplied by the number of positions in corrected rate by using reduction coefficient shown in the right columns. The total sum of these values makes the test current intensity to be applied for the test.

7.2.14 Temperature Rising:

Contact loaded and mated pair of connector assemblies shall be tested for temperature rising by applying test current calculated in the same manner as you did in current cycling test. Temperature rising of connectors shall be measured by applying basic current value on 4 centering contact positions and one half of its intensity on remaining positions respectively. Measurement shall be done on the surface of centering portion of connectors, after energizing for 2 hours. The risen temperature shall not exceed 65 degrees after deducting the value of room temperature from the measured reading. This test shall be also conducted in the draft-free test chamber.

SHEET			AMP (Japan), Ltd. TOKYO, JAPAN	
7 OF 16	LOC	NO	108-5099	REV
	J	A		E.1
NAME Product Specification				
Multi-interlock Connector				

7.2.15 Repeated Insertion/Extraction:

Repeated insertion/extraction test conditioning shall be applied by fastening a contact-filled connector assembly to the head of test machine, and operate the head to travel in axial direction of the connector to mate and unmate reciprocatingly with the speed at a rate of 100mm a minute for 50 cycles.

7.2.16 "Kojiri" Resistibility:

Note:

"Kojiri" is a Japanese term, meaning the motions to give forcing stress to a fixed set of parts such as mated connector halves or contacts, in such manner of twisting, bending and rolling in the directions amiss to contact mating/unmating axis, resulting detrimental effects or parts, especially deformation or contacts or breakage of housing etc.

Apply one cycle each of reciprocating, twisting and bending torque of 196N.cm (20Kgf.cm) (T) at every 1 mm depth in contact unmating stroke to sum up to 50 cycles in total on one half of mated connectors with the couterpart secured on test stand stably, until the connector halves are separated.

After separation, mate the halves again and conduct the test in the same manner in transverse direction performed in the previous step of testing.

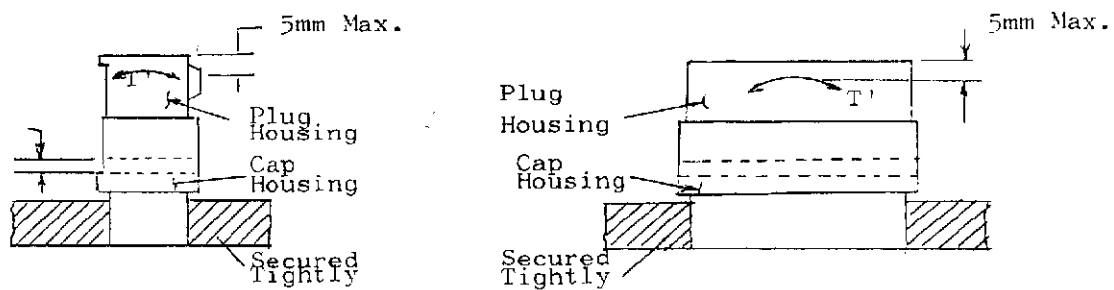

Fig. 4

7.2.17 Heat Resistibility:

Expose the mated connectors under elevated temperature for 2 hours in the test oven, where 100°C is maintained, and after reconditioning in the room temperature, the connector assemblies shall be tested in accordance with the test sequence specified in Table 5.

7.2.18 Cold Resistibility:

Expose the mated connector assebmlies under cold atmosphere for 2 hours in the test chamber, where temperature of -50°C is maintained, and after reconditioning in the room temperature, the connector assemblies shall be tested in accordance with the test sequence specified in Table 5.

SHEET	AMP		AMP (Japan), Ltd. TOKYO, JAPAN	
8 OF 16	LOC J A	NO 108-5099	REV E1	
NAME Product Specification				
Multi-interlock Connector				

7.2.19 Thermal Shock:

Expose mated pair of connector assemblies under 5 cycles of thermal shock conditioning in the test oven, where the temperature is controlled to change between the specified extremes in durations as shown in Table 3 below, and after exposure, connector assemblies shall be reconditioned in the room temperature, and tested in accordance with the test sequence specified in Table 5.

Test Sequence	Temperature Extremes and Durations
1	80 ±5°C for 2 hours
2	Room Temperature for 5 minutes (Maximum)
3	-30 ±5 C for 2 hours
4	Room Temperature for 5 minutes

Table 3

7.2.20 Humidity(Steady State):

Contact-loaded and mated pair of connector assemblies shall be exposed in test chamber for 48 hours with test current of 28V applied in the contact circuit as shown in Fig. 3, where the temperature of 60 ±5°C with the relative humidity of 90 - 95% is maintained. After reconditioned in the room temperature, connector assemblies shall be tested in accordance with the test sequence specified in Table 5.

7.2.21 Salt Spray:

Contact loaded and mated pair of connector assemblies shall be exposed under 5% salt solution spray for two durations of 24 hours testing with an interval of suspension for 1 hour between them, in accordance with JIS C 5028. After conditioning durations lins the sample with the tap water to remove salt saturation from the sample, and dry in the room temperature for 1 hour before testing in accordance with the test sequence specified in Table 5.

7.2.22 Dust Bombardment:

Hang a mated pair of connector assemblies in the middle of closed test chamber, where the connector assemblies are subject to undergo dusting test by ejecting Portland powdered cement conforming to JIS R 5210 by the aid of compressed air and powered fan to blow it uniformly for 1 hour, at a rate of 1.5 kg per 10 seconds in the intervals of 15 minutes. After test conditioning, connector shall be tested for performance in accordance with the test sequence specified in Table 5. The connector assemblies shall be hung in the manner as shown in Fig. 5.

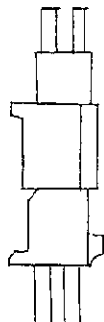

SHEET	AMP		AMP (Japan), Ltd. TOKYO, JAPAN	
9 OF 16	LOC	NO	REV	
	J	A	108-5099	E
NAME Product Specification				
Multi-interlock Connector				

7.2.23 Icing:

After immersing mated connector assemblies in the boiling hot water for 1 hour, take them out from the heating tub, and have them exposed under the chilly atmosphere at $-30 \pm 5^{\circ}\text{C}$ in the test chamber to let drenching water turn to ice. As the assemblies are chilled and frozen, take them out from the chamber again and recondition in the room temperature to let ice melt away. After the icing conditioning, the assemblies shall be tested in accordance with the test sequence specified in Table 5.

7.2.24 Vibration(High Frequency):

Contact loaded and mated pair of connector assemblies shall be tested on the vibration testing machine by securing the samples on the vibrating plate as shown in Fig. 6, with all the contacts series wired and energized with the test current of 0.1A at 12V DC applied to the circuit during the test. Sweeping vibration to reciprocate cycles between 20 and 200 Hz. to make one cycle a minute at accelerated velocity of 4.5G's applied to the samples for 8 hours. The test circuit shall be monitored if electrical discontinuity greater than 1 microsecond takes place during the test.

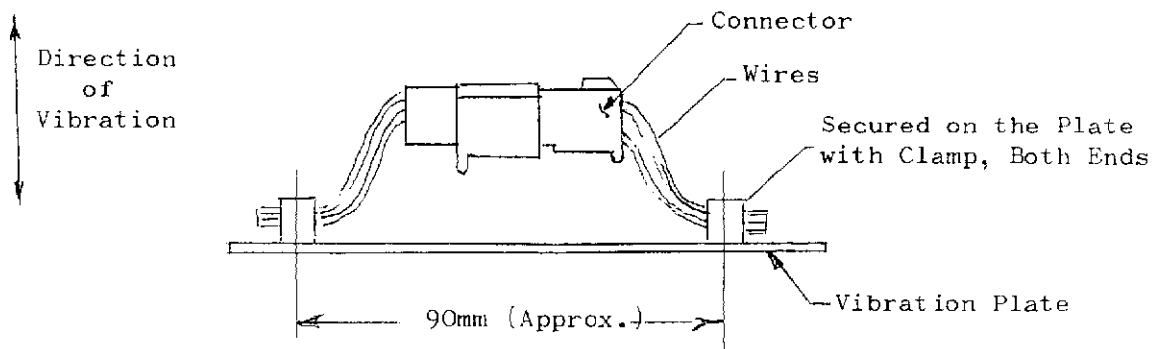

Fig. 6

7.2.25 Vibration (Low Frequency per SAE J 577):

Contact-loaded and mated pair of connector assemblies shall be tested on the vibration testing machine specified in SAE J 577, except that cam-drop stroke to be 3.2mm and spring tension force to be 265-314N(27-32kgf), with all the contacts series wired and energized with test current of 0.1A at open circuit voltage of 12V DC flowing through the circuit during the test. The vibrating condition at 750 Hz shall be applied to the sample for 1 hour. The test circuit shall be monitored if electrical discontinuity greater than 1 microsecond takes place during the test.

SHEET			AMP (Japan), Ltd.	
10 OF 16			TOKYO, JAPAN	
LOC	J	NO	108-5099	REV
NAME	Product Specification			
	Multi-interlock Connector			

7.2.26 Vibration (High Frequency at Direct Mounting):

Contact-loaded and mated pair of connector assemblies shall be tested on the vibration testing machine by securing the samples directly on the vibration plate as shown in Fig. 7. with all the contacts series wired and energized with the test current of 0.1A at open circuit voltage of 12V DC flowing through the circuit during the test. Sweeping vibration to reciprocate between 20 and 200 Hz. changing a cycle a minute at accelerated velocity of 44m/s^2 (4.5G) shall be applied to the samples for 8 hours. The test circuit shall be monitored if electrical discontinuity greater than 1 microsecond takes place. during the test.

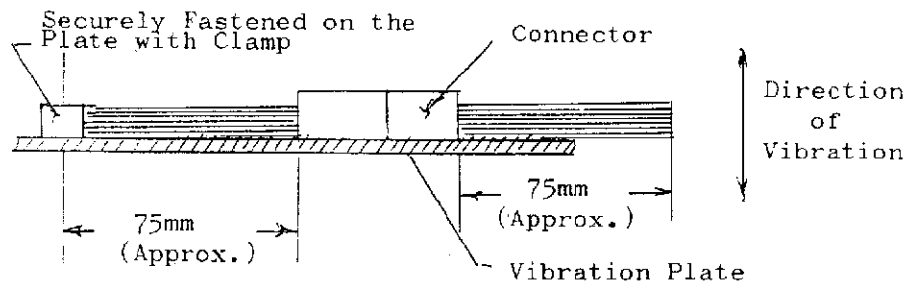

Fig. 7

7.2.27 Current Overload:

Contact-loaded and mated connector assemblies shall be tested for current over-load withstanding performance, by applying test current at excessively high intensity of the values specified in Table 4 for 1 minute. Connector assemblies must be held in horizontal direction and carefully observed if the housing starts showing any abnormal affection by the effect of over-loaded current.

Wire Size		Overload Current (A) DC
mm ²	(AWG)	
0.5	(#20)	50
0.85	(#18)	75
1.25	(#16)	100
2.0	(#14)	200

Table 4

SHEET		AMP		AMP (Japan), Ltd.	
11 OF 16				TOKYO, JAPAN	
LOC	J A	NO	108-5099	REV	E 1
NAME Product Specification					
Multi-interlock Connector					

SECURITY CLASSIFICATION: Customer Release
 NUMBER: 108-5099

7.2.28 Panel Locking Retention Force (To be applied to panel-locking type, cap housing only):

Mount mated pair of connectors on the panel with normal engagement on counterpart holder. Apply an axial pull-off load to the free end of connector on the tensile testing machine by operating the head to travel with the speed at a rate of 100mm approximately a minute. The force required to disengage the connectors with or without break-off of locking device. (The counterpart holder shall be applied to the test after approval of AMP-Japan Engineering.)

7.2.29 Contact Loading Force:

Insert wire-crimped contact into housing cavity, and measure the force required to insert and lock the contact in position by travelling the head with the speed at a rate of 100mm a minute approximately.

SHEET	AMP			AMP (Japan), Ltd.	
				Kawasaki, Japan	
12 OF 16	LOC J	LOC A	NO 108-5099	REV. E1	
NAME Product Specification					
Multi-interlock Connector					

7.3 Test Sequence:

All the tests shall be conducted in accordance with the test sequence and classified sample groups specified in Table 5.

NUMBER 108-5099
Customer Release
AMP SECURITY CLASSIFICATION

Classification	Single Contact Part		Connector Test Sequence																			
	I	II	I				II				III				IV							
Appearance	1	1					1				1				1				19			
Insertion Force	2	2					2				2				2				20			
Extraction Force	5	8					8				8				8				18			
Termination Resistance (Low Level)	3	3	11	14	17	21	24	3	11	15	18	22	3	11	14	17	20	3	11	14		
Termination Resistance Handling Touch of Insertion/Extraction of Contact	4	4	12	15	18	22	25	4	12	16	19	23	4	12	15	18	21	4	12	15		
	6	9					26	9				24	9				22	9			21	
Insulation Resistance		6					6				6				6				6			
Dielectric Strength		7					7	13			7				7				7			16
Current Leakage		5			19		5			20	5				5				5			17
Current Cycling					20																	
Temperature Rising						23																
Contact Retention Force							28				25					23						
Crimp Tensile Strength	1																					
Housing Retention Force							27				26					24						
Repeated Insertion and Extraction																	10					
"Kojiri" Resistibility		10													10							
Heat Resistibility								10														
Cold Resistibility									14													
Thermal Shock											21											
Humidity (Steady State)											17											
Salt Spray																					13	
Dust and Sand Bombardment			13																			
Icing				16																		
Vibration (High Frequency)															13							
Vibration (Low Frequency per SAE J 577)																16						
Vibration (High Frequency at Direct Mounting on Vibration Plate)																	19					
Current Overload																					22	

Table 5

SHEET

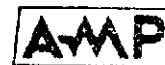

AMP (Japan), Ltd.
TOKYO, JAPAN

13 OF 16

LOC J A

NO 108-5099

REV E1

NAME Product Specification
Multi-interlock Connector

NUMBER 108-5099
 AMP SECURITY CLASSIFICATION
 Customer Release

8. Quality Assurance Provisions:

8.1 Test Conditions:

Unless otherwise specified, all the tests shall be conducted in any combination of the following test conditions.

- Temperature: 15 - 35°C
- Relative Humidity: 45 - 75%
- Atmospheric Pressure: 86.7 - 107KPa(650 - 800mmHg)

8.2 Test:

8.2.1 Test Specimens:

All the specimens to be used for the tests shall be prepared in accordance AMP Application Specifications, 114-5004 and 114-5018, "Multi-interlock Connectors, Crimping Contacts of" using the wires of the specified sizes conforming to Table 6. No samples are allowed to be used for the tests unless otherwise specified.

8.2.2 Number of Specimens:

Specimens used for the tests shall consists of 10 or more pairs of contacts when testing contacts only, and of 2 or more pairs of mating connectors when testing connector assemblies.

8.2.3 Wire Used:

All the wires used for the performance testing shall be conforming to the specification as shown in Table 6.

Wire Sizes (Nominal)		Composition of Strands		Cross-sectional Area	
mm ²	(AWG)	Strand Dia-meter (MM)	Number of Strands	mm ²	CMA
0.3	(#22)	0.18	12	0.31	602
0.3	(#22)	0.18	7	0.37	733
0.5	(#20)	0.32	7	0.51	1,111
0.85	(#18)	0.32	11	0.88	1,746
1.25	(#16)	0.32	16	1.28	2,540
2.0	(#14)	0.32	26	2.09	4,128

Table 6

SHEET				AMP (Japan), Ltd.	
14 OF 16				TOKYO, JAPAN	
LOC	J	A	NO	108-5099	REV
NAME		Product Specification			
Multi-interlock Connector					

9 Special Instructions to Keep Good Workmanship:

9.1 Crimping:

All the wire crimping work shall be performed in conformance with the specified procedures and quality acceptance level of AMP Application Specifications, 114-5004 and 114-5018, Multi-interlock Connector, crimping Contacts of" in order to maintain good workmanship to meet designated performance requirements of housing and contacts.

9.2 Taping Wire Bundles at Harness Assembly:

In order to provide slack play on the wires leading out from housing, the leads must be kept untied by wrapping tape to a portion of 30mm next to the housing entry, so that loaded contacts can be kept being free from ill-affectation by excessive stress in handling, as shown in Fig. 8.

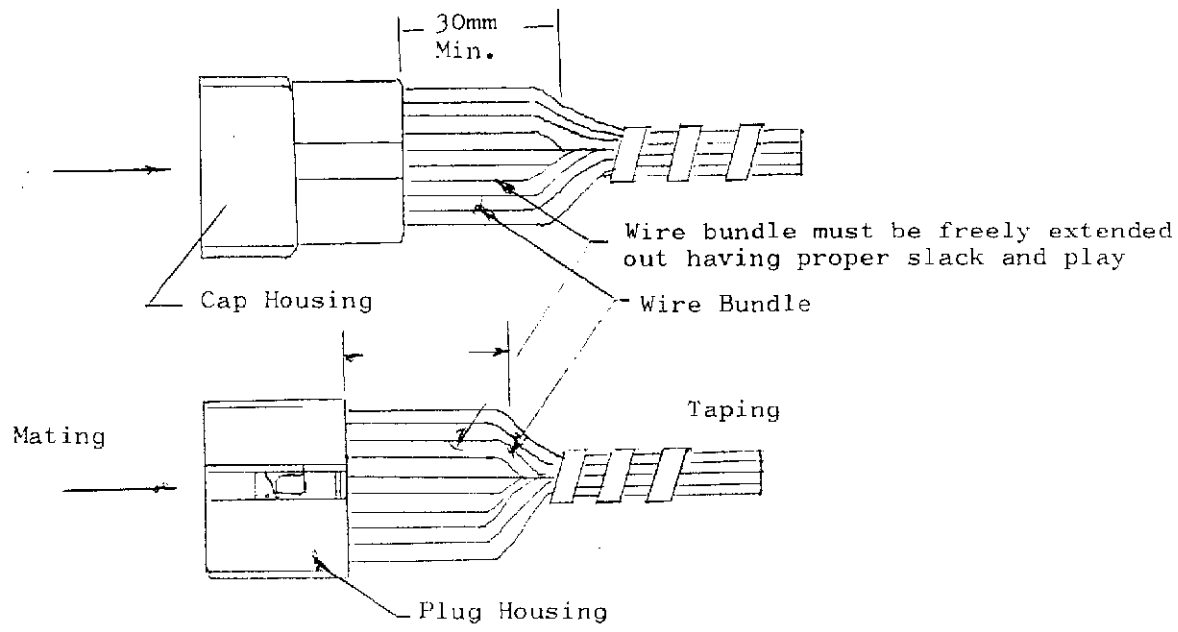

9.3 Application Tooling:

AMP specified application tooling must be used for preparing samples. When to remove contact from housing cavity, use AMP extraction tool, referring to Instruction Sheet IS-034J.

9.4 Connector Unmating:

When to unmate connector halves, do not pull off by gripping wire bundles. Be sure to grip housing and pull straight back, in order to prevent damage on contacts and crimped wires. However, removal by gripping more than 3 wires may be allowable, only if no excessive force is given when pulling off.

SHEET		AMP		AMP (Japan), Ltd. TOKYO, JAPAN	
15 OF 16		LOC	NO	REV	
		J	A	E1	
		NO 108-5099			
NAME Product Specification					
Multi-interlock Connector					

NUMBER
108-5099

AMP SECURITY
CLASSIFICATION
Customer
Release

10 Reference Documents:

- JASO D 605 Multi-Connectors for Automotives
- JASO 7101 Testing Method of Molded Plastic Parts for Automobile
- JIS C 3406 Low-Voltage Cables for Automobiles
- JIS D 0203 Method of Moisture, Rain and Spray Test for Automobile Parts
- JIS D 0204 Method of High and Low Temperature Test for Automobile Parts
- JIS D 1601 Vibrtile Testing Method for Automobile Parts
- JIS R 5210 Portland Cement
- JIS C 5028 Salt Mist Testing Method for Electronic Components
- JIS D 5500 Lighting and Signalling Equipment for Automobiles
- 114-5004 Multi-interlock Connector Contacts, Crimping of
- 114-5008 Multi-interlock Connector Contacts, Crimping of

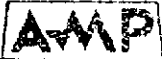
SHEET				AMP (Japan), Ltd. TOKYO, JAPAN	
16OF16		LOC	NO	REV	
		J	A	108-5099 E	
NAME Product Specification					
Multi-interlock Connector					

製品規格

108-5099

マルチ・インターロック・コネクタ (M.I.C)

1. 適用範囲

本規格は、エー・エム・ビー社で製造されるマルチ・インターロック・コネクタ (M.I.C) の内、電線対電線中継接続用の下記型番のコンタクト及びハウジングについて規定する。

2. 対象型番及び名称

2.1 コンタクト

2.1.1 リセブタクル コンタクト (以下リセブタクルという)

型番 : 170177, 170286, 170307, 170189, 170487
 170289

2.1.2 タブ コンタクト (以下タブという)

型番 : 170221, 170308, 170222, 170459

2.2 ハウジング

極数	名称	プラグハウジング	キャップハウジング	パネルロックタイプ キャップハウジング
5		172026	172044	172389
7		172025	172043	172390
9		171892	172042 172096 (フランジ付き)	172391
11		172024	172041	172392
13		171358	171725	172393
17		171354	171827 171828 (フランジ付き)	172395
21		171364	171829 171830 (フランジ付き)	—
15		172388	—	172394

E1	改訂 RJA-1749-99		K.K	K.K	10/19/99		
E	改訂 RFA-1946				1/27/92		
D	改訂 RFA-522	100	外	外	2/25/81		
C	改訂 RFA-426	15	外	外	1/16/79	作成 :	分類 : 製品規格
B	改訂 RFA-355	外	外	外	1/21/77	外 2/20/77	
A	REVISED RFA-303	外	外	外	3/10/77	検閲 :	コード : 108-5099
O	作成 RFA-248	外	外	外	5/2/76	承認 :	改訂 E1
改訂	改訂記録	作成	検閲	承認	年月日	承認 :	名称 : マルチ・インターロック コネクタ (M.I.C)
昭和 53 年 3 月 10 日 制定				1 頁 15 頁中		承認 : 3/19/77	

3. 用語の意味

本規格に適用する用語の意味は次の通りとする。

3.1 コンタクト

コネクタの構成部品である接触子をいう。これにはリセブタクルとタブがある。

3.2ハウジング

コネクタの構成部品でコンタクトを収容するものをいう。これには、リセブタクルを収容するプラグ・ハウジングとタブを収容するキャップ・ハウジングがある。

3.3 コネクタ

電線を圧着したコンタクトをハウジングに全極アッセンブリしたものをいう。これには、リセブタクルとプラグ・ハウジングをアッセンブリしたものと、タブとキャップハウジングをアッセンブリしたものがある。

4. 使用材料、表面処理

4.1 コンタクト

コンタクトはASTM B36 COPPER ALLOY 260 に準拠する錫メッキ付黄銅条より製造される。

4.2 ハウジング

ハウジングはナイロン樹脂により製造される。

5. 形状、構造及び寸法

5.1 コンタクト

コンタクトの形状、構造及び寸法は図面に合致していること。又、全てのタブとリセブタクルは適用電線範囲に関係なく相互に嵌合できる。

5.2 ハウジング

ハウジングの形状、構造及び寸法は図面に合致していること。又、誤嵌合防止機構及びハウジング相互のロック機構を有する。

6. 使用条件

6.1 使用温度範囲

-30～105℃(周囲温度+通電による温度上昇)

分類： 製品規格	標準の名称： マルチ・インターロック・コネクタ(M.I.C)	標準のコード： 108-5099	改訂 E1	2 頁 15 頁中
-------------	-----------------------------------	---------------------	----------	--------------

6.2 適用電線範囲

カタログ番号	適用電線範囲	絶縁被覆外径
170177 170122 170222 170322 170222 170222 170222 170222	0.5 ~ 2.27 mm ² (AWG # 20 ~ # 14) 1本 または 0.5 + 0.5 mm ² , 0.5 + 0.85 mm ² 2本圧着	2.1 ~ 3.4 mm
170307 170307 170307 170307 170307 170307 170307 170307	0.3 ~ 0.89 mm ² (AWG # 22 ~ # 18) 1本	1.5 ~ 2.6 mm

7. 性能及び試験方法

7.1 性能

第7.2項「試験方法」及び第7.3項「試験順序」に基づき試験した結果、第1表の性能を満足すること。

第1表

項目	分類	コンタクトの性能		コネクタの性能		
		試験方法	初期性能	初期性能	環境耐久試験後の性能	
外観	7.2.1		亀裂、割損、破損、がた、部品のはずれ、錆び、溶解等で機能を損う欠点のないこと。			
コンタクト又はコネクタ挿力	7.2.2	2.9-8.3N (0.3 ~ 0.85 kgf)	5極	— 59N (6 kgf) 以下		
			7極	— 74N (7.5kgf) 以下		
			9極	— 88N (9 kgf) 以下		
			11極	— 103N (10.5kgf) 以下		
			13極	— 123N (12.5kgf) 以下		
			17極	— 157N (16 kgf) 以下		
			21極	— 186N (19 kgf) 以下		
			22極	— 9極及び13極参照		
コンタクト又はコネクタ引抜き力	7.2.3	1.5-8.3N (0.15 ~ 0.85 kgf)	5極	6.9 ~ 59N (0.7 ~ 6 kgf)		
			7極	9.8 ~ 74N (1 ~ 7.5kgf)		
			9極	12.7 ~ 88N (1.3 ~ 9 kgf)		
			11極	15.7 ~ 103N (1.6 ~ 10.5kgf)		
			13極	19.6 ~ 123N (2 ~ 12.5kgf)		
			17極	24.5 ~ 157N (2.5 ~ 16 kgf)		
			21極	31.4 ~ 186N (3.2 ~ 19 kgf)		
			22極	— 9極及び13極参照		
コネクタ挿入力(追加)	7.2.2	—	15極	142N (14.5kgf) 以下		
コネクタ引抜き力(追加)	7.2.3	—	15極	21.6 ~ 142N (2.2 ~ 14.5kgf)		
分類： 製品規格	標準の名称： マルチ・インターロック・コネクタ(M.I.C)		標準のコード： 108-5099		改訂 E1	

第 1 表 (続き)

項 目	分 類	コネクタの性能		
		試験方法	初期性能	初期性能 環境耐久試験後の性能
ローレベル抵抗	7.2.4	3mΩ以下	3mΩ以下	6mΩ以下
総合抵抗	7.2.5	3mV/A以下	3mV/A以下	6mV/A以下
挿抜のフィーリング	7.2.6	有害な引掛り等のないこと。		
絶縁抵抗	7.2.7	100MΩ以上		
耐電圧	7.2.8	AC 1,800V, 1分間にて異常なきこと。		
リーク電流	7.2.9	3mA以下		
コンタクト保持力	7.2.10	58.8N(6kgf)以上		
圧着部引張強度	7.2.11	0.3 mm ² - 49N(5kgf)以上	—————//—————	
		0.5 mm ² - 88N(9kgf)以上		
		0.85 mm ² - 127N(13kgf)以上		
		1.25 mm ² - 177N(18kgf)以上		
		2 mm ² - 265N(27kgf)以上		
ハウジング保持力	7.2.12	—————//—————	98N(10kgf)以上	
電流サイクル	7.2.13			
温度上昇	7.2.14			
繰返し挿抜	7.2.15			
耐とじり性	7.2.16			
耐熱性	7.2.17			
耐寒性	7.2.18			
熱衝撃	7.2.19	—————//—————		
耐湿性(定常状態)	7.2.20			
塩水噴霧	7.2.21			
耐塵性	7.2.22			
アイソング	7.2.23			
高周波振動	7.2.24			
耐衝撃性(I)	7.2.25			
耐衝撃性(II)	7.2.26			
過電流耐力	7.2.27	着火のないこと。		
パネルロック保持力	7.2.28	—————//—————	196N(20kgf)以上	
コンタクト装着力	7.2.29	—————//—————	14.7N(1.5kgf)以下	
分類：	製品規格	標準の名称：	標準のコード：	改訂
		マルチ・インターロック・コネクタ(M.I.C)	108-5099	E
				1 頁 15頁中

第5表に示す項目の耐久・環境試験後の性能を満足すること。

7.2 試験方法

7.2.1 外観

外観を目視及び触覚により観察し、有害な亀裂、割損、破損、がた、部品のはずれ、錆、溶解及び変形等の有無を確認する。

7.2.2 コンタクト又はコネクタ挿入力

コンタクト又はコネクタの一方を固定し、他方を軸方向に毎分約 100 mm の一定速度で操作する。なお、ハウジングのロック機構のあるコネクタはこれを作用させて行なう。

7.2.3 コンタクト又はコネクタ引抜力

コンタクト又はコネクタの一方を固定し、他方を軸方向に毎分約 100 mm の一定速度で操作する。なお、ハウジングのロック機構は作用させないで行なう。

7.2.4 ローレベル抵抗

コンタクト又はコネクタを嵌合した状態で開放電圧 DC 50 mV 以下、短絡電流 50mA 以下を通电し、圧着部より 75 mm 離れた点で抵抗を測定する。

(才1図の Y - Y' 間)

ローレベル抵抗は、Y - Y' 間の抵抗から 150 mm の電線の抵抗分を差引いて算出する。なお、測定は 1 極ずつ行なうものとする。

才 1 図

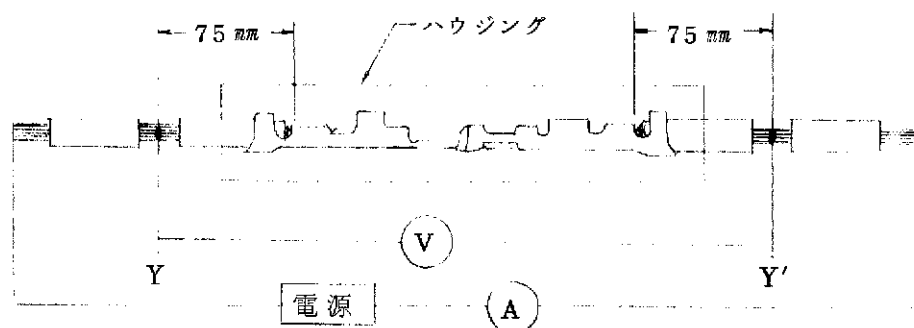

7.2.5 総合抵抗

コンタクト又はコネクタを嵌合した状態で開放電圧 DC 12V、短絡電流 1A を通电し、コンタクトの温度が安定した後、圧着部より 75 mm 離れた点で電圧降下を測定する。

(才1図の Y - Y' 間)

総合抵抗は Y - Y' 間の電圧降下から 150 mm の電線の電圧降下を差引いて算出する。なお、測定は 1 極ずつ行なうものとする。

分類： 製品規格	標準の名称： マルチ・インターロック・コネクタ (M. I. C)	標準のコード： 108-5099	改訂 E ₁	5 15 頁
-------------	--------------------------------------	---------------------	----------------------	-----------

7.2.6 挿抜のフィーリング

コンタクト又はコネクタの挿入，引抜きを手動にて行ない，そのフィーリングを触感にて確認する。

7.2.7 絶縁抵抗

コネクタを嵌合した状態で，才2図の如く隣接するコンタクト相互間及びコンタクト対ハウジング間（対アース間）を測定する。

なお，測定電圧はDC 500Vとする。

才 2 図

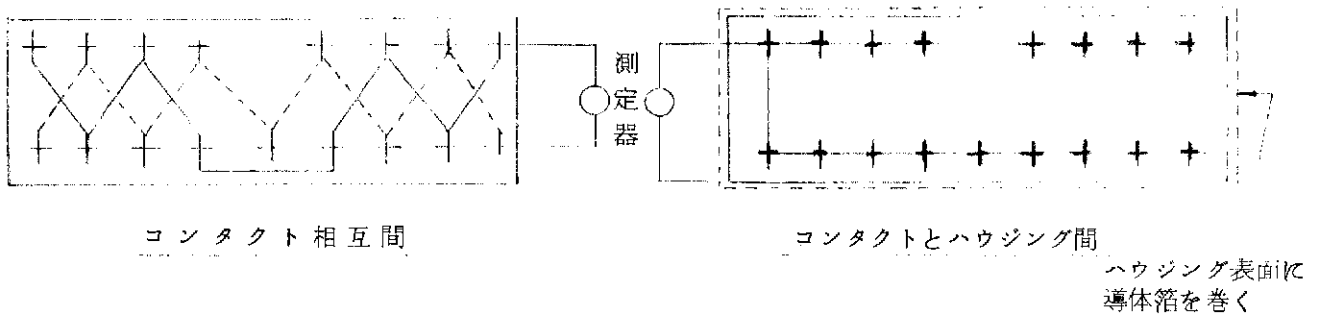

7.2.8 耐電圧

コネクタを嵌合した状態で，才2図の如く隣接するコンタクト相互間及びコンタクト対ハウジング間（対アース間）に商用周波数のAC 1,800Vを1分間印加する。

7.2.9 リーク電流

コネクタを嵌合した状態で，温度 $60 \pm 5^\circ\text{C}$ ，湿度 90~95% に保たれた恒温恒湿槽中に1時間放置した後，槽内で才3図の如く隣接するコンタクト相互間にDC 12Vを印加する。

才 3 図

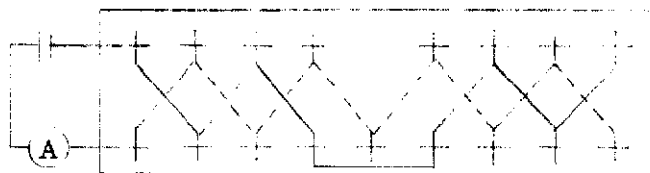

分類： 製品規格	標準の名称： マルチ・インターロック・コネクタ (M.I.C)	標準のコード： 108-5099	改訂 E 1	6 / 15 頁
-------------	------------------------------------	---------------------	-----------	----------

7.2.10 コンタクト保持力

ハウジングに、約100mmの長さ、0.85mm²以上の断面積の電線を圧着したコンタクトが組込まれたコネクタを固定し、電線を軸方向へ毎分約100mmの一定速度で引張り、コンタクトがハウジングから抜けた時の荷重を測定する。

7.2.11 圧着部引張強度

約100mmの長さの電線を圧着したコンタクトを固定し、電線を軸方向に毎分約100mmの一定速度で引張り、電線の破断又は圧着部から電線の引抜けた時の荷重を測定する。

7.2.12 ハウジング保持力

コネクタを嵌合し、ロック機構の作用した状態で一方を固定し、他方を軸方向に、毎分約100mmの一定速度で引張り、ロック機構の外れ又は破損して嵌合の外れた時の荷重を測定する。

7.2.13 電流サイクル

コネクタを嵌合した状態で中心4極に才2表から算出される電流を他の回路には、その1/2の電流を通電する。通電45分間、休止15分間を1サイクルとして200サイクル行なう。なお、試験は無風状態で行なう。

才 2 表

電線サイズ (mm ²)	電流値 (DC A)	極 数	減少係数
0.5	11	1	1
0.85	14.5	2 ~ 3	0.75
1.25	18.5	4 ~ 5	0.6
2	25	6 ~ 8	0.55
		9 ~ 12	0.5
		13以上	0.4

(注) 通電電流は、各電線サイズに対応する電流値と極数に対応する減少係数との積から算出される。

7.2.14 温度上昇

コネクタを嵌合した状態で中心4極に才2表から算出される電流を、他の回路にはその $\frac{1}{2}$ の電流を2時間通電し、ハウジング中央表面部の温度を測定する。この測定された温度から室温を差引いた値が、 65°C 以下であるかの確認を行なう。
なお、試験は無風状態で行う。

7.2.15 繰り返し挿抜

コネクタの一方を固定し、他方を軸方向に毎分約 100mm の一定速度で操作し、挿入、引抜きを50回行なう。

7.2.16 耐こじり性

コネクタを引抜時に才4図の如くコネクタの一方を固定し、他方を 1mm 間隔でコンタクト同志の嵌合がはずれるまで引抜きながら、各段階で前後方向に1往復、 $196\text{N}\cdot\text{cm}$ ($20\text{kgf}\cdot\text{cm}$) (T)のトルクを加える。これを1サイクルとして50サイクル行う。次に左右方向も同様に1往復 $196\text{N}\cdot\text{cm}$ ($20\text{kg}\cdot\text{cmf}$) (T')のトルクを加える。これを1サイクルとして50サイクル行う。

才 4 図

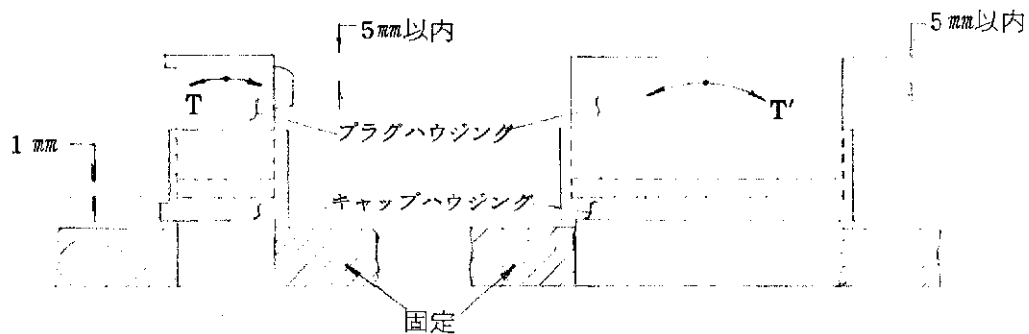

7.2.17 耐熱性

コネクタを嵌合した状態で 100°C に保たれた恒温槽に2時間放置し、その後取り出して常温に戻るまで放置する。

7.2.18 耐寒性

コネクタを嵌合した状態で -50°C に保たれた恒温槽に2時間放置し、その後取り出して常温に戻るまで放置する。

7.2.19 熱衝撃

コネクタを嵌合した状態で才3表に示す試験を1サイクルとして、これを5サイクル行った後、室温に戻るまで放置する。

分類：	標準の名称：	標準のコード：	改訂	
製品規格	マルチ・インターロック・コネクタ(M.I.C)	108-5099	E	$\frac{8}{15}$ 頁

才 3 表

試験順序	試験方法
1	80±5℃ 2時間
2	室温 5分以内
3	-30±5℃ 2時間
4	室温 5分以内

7.2.20 耐湿性（定常状態）

コネクタを嵌合し才3図の如く接続，DC 28Vを印加した状態で，温度 $60\pm 5^{\circ}\text{C}$ ，湿度90～95%に保たれた恒温恒湿槽中に48時間放置した後，取り出して常温に戻るまで放置する。

7.2.21 塩水噴霧

コネクタを嵌合した状態で，JISC 5028に基づいて5%の塩水を24時間噴霧，1時間休止，24時間噴霧し，塩の堆積物を水洗した後1時間常温にて乾燥する。

7.2.22 耐塵性

縦，横，高さがそれぞれ900～1,200mmの密閉タンク内にコネクタを嵌合した状態で才5図の如く吊し，ポルトランドセメント（JISR 5210）1.5kgを15分毎に10秒間圧縮空気を噴射し，ファン等で一様に拡散させ，これを1時間行った後密閉タンク内から取り出す。

才 5 図

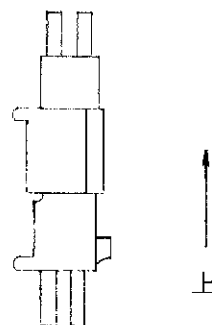

分類： 製品規格	標準の名称： マルチ・インターロック・コネクタ（M.I.C）	標準のコード： 108-5099	改訂 E 1	9 15 頁
-------------	-----------------------------------	---------------------	-----------	-----------

7.2.23 アイシング

嵌合したコネクタを沸騰している水に1時間浸漬した後、直ちに $-30 \pm 5^{\circ}\text{C}$ の恒温槽に入れ附着した水が氷結するまで放置する。

その後取り出して、氷が融解するまで放置する。

7.2.24 高周波振動

コネクタを嵌合，全極直列に接続し，開放電圧DC 12V，短絡電流0.1 Aを通电した状態で才6図の如く振動試験機に取り付ける。振動加速度は4.5 g，振動周波数は20～200 Hzを往復1分間でスイープさせる。これを8時間行い1 m sec以上の瞬断の有無を観察する。

才 6 図

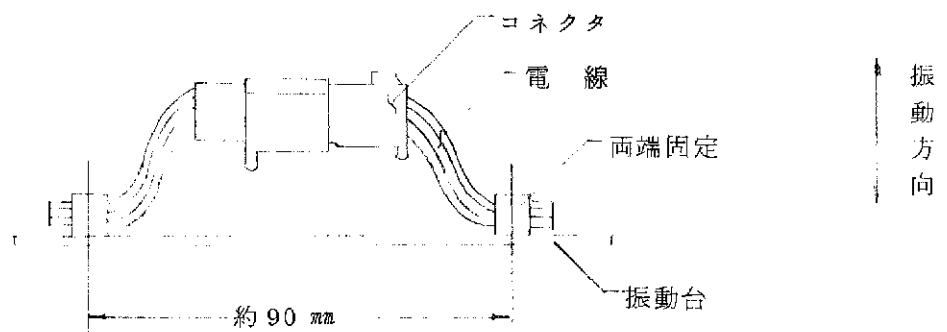

7.2.25 耐衝撃性(I)

コネクタを嵌合，全極直列に接続し開放電圧DC 12V，短絡電流0.1 Aを通电した状態で才6図の如くSAE J 577による試験装置に取り付け，振動数750Hz，カム落下3.2 mm，衝撃台の端でのスプリング張力265～314N(27～32kgf)で1時間行い，1msec以上の瞬断の有無を確認する。

分類：	標準の名称：	標準のコード：	改訂	10
製品規格	マルチ・インターロック・コネクタ(M.I.C)	108-5099	E1	15 頁

7.2.26 耐衝撃性(Ⅱ)

コネクタを嵌合、全極直列に接続し開放電圧DC12V、短絡電流0.1Aを通電した状態で第7図の如く振動試験機に取り付ける。振動加速度は 44m/s^2 (4.5G)、振動周波数は20~200Hzを往復1分間でスイープさせる。これを8時間行ない、1m sec以上の瞬断の有無を観察する。

第 7 図

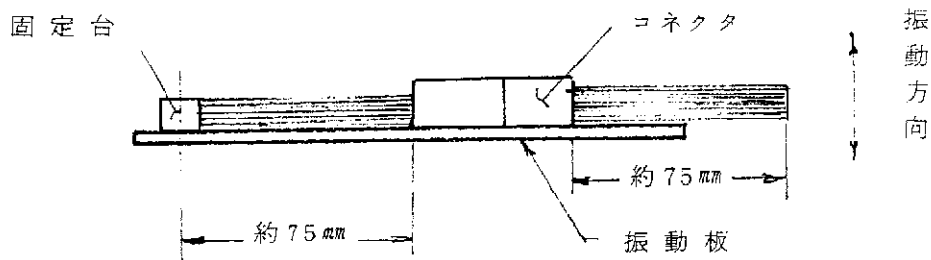

7.2.27 過電流耐力

コネクタを嵌合した状態で水平に保ち、1極に第4表の電流を1分間通電し、ハウジングへの着火の有無を観察する。

第 4 表

電線サイズ (mm)	過電電流 (DC A)
0.5	50
0.85	75
1.25	100
2	200

7.2.28 パネルロック保持力 (パネルロックタイプキャップハウジングのみに適用)

相手側ホルダーと嵌合した状態で一方を固定し他方を軸方向に毎分約100mmの一定速度で引張り、ロック機構の外れ又は破損して嵌合の外れた時の荷重を測定する。(相手側ホルダーはAMPで確認したものを使用すること)

7.2.29 コンタクト装着力

電線を圧着したコンタクトをハウジングに装着し、ランスが引掛るまでの力を装着力として測定する。

力は電線の軸方向へ毎分約100mmの一定速度で加えるものとする。

7.3 試験順序

試験順序は才5表に示すグループ毎の順序に従って行うものとする。

才 5 表

区 分 項 目	コネクタ 単体		コネクタ試験順序					V	
	I	II	I	II	III	IV			
外 観	1	1		1		1	1	19	I
コネクタ又はコネクタ挿入力	2	2		2		2	2	20	
コネクタ又はコネクタ引抜き	5	8		8		8	8	18	
ローレベル抵抗	3	3	11 14 17 21 24	3 11 15 18 22	3 11 14 17 20	3 11 14			
総合抵抗	4	4	12 15 18 22 25	4 12 16 19 23	4 12 15 18 21	4 12 15			
挿抜のフィーリング	6	9	26	9 24	9 22	9 21			
絶縁抵抗		6		6		6			
耐電圧		7		7 13		7	7	16	
リーク電流		5	19	5 20		5	5	17	
電流サイクル			20						
温度上昇			23						
コネクタ保持力			28		25	23			
圧着部引張強度	1								
ハウジング保持力			27		26	24			
繰返し挿抜						10			
耐こじり性		10			10				
耐熱性				10					
耐寒性				14					
耐熱衝撃					21				
耐湿性(定常状態)					17				
塩水噴霧							13		
耐塵性			13						
アイシニング			16						
高周波振動						13			
耐衝撃性(I)						16			
耐衝撃性(II)							19		
過電流耐力								22	
パネルロック保持力				29					
コネクタ装着力									2

分類:

製品規格

標準の名称:

マルチ・インターロック・コネクタ(M.I.C)

標準のコード:

108-5099

改訂

E1

12

15 頁

8. 品質保証条件

8.1 試験条件

特に指定のない場合は、下記に示す環境条件のもとで性能試験を行なうものとする。

温 度	15～35℃
相 対 湿 度	45～75%
気 圧	86.7～107KPa (650～800mmHg)

8.2 試 験

8.2.1 試 料

性能試験に用いる試料は、「マルチ・インターロック・コネクタ・コンタクト
圧着条件114-5004および114-5018」に基づいて才6表に示す電線に
圧着した正規の試料であること。

いずれの試料も規定された順序以外の他の試験に用いてはならない。

8.2.2 試 料 数

性能試験に用いる試料数は各グループ毎にコンタクト単体の場合10セット、コ
ネクタの場合2セット以上で行なうものとする。

8.2.3 使用電線

性能試験に用いる電線は才6表に示す電線にて行なうものとする。

才 6 表

電線サイズ		素線構成		断 面 積	
呼 び	AWG	素線径 (mm)	素線数	mm ²	CMA
0.3	#22	0.18	12	0.31	602
0.3	#22	0.18	7	0.37	733
0.5	#20	0.32	7	0.56	1111
0.85	#18	0.32	11	0.88	1746
1.25	#16	0.32	16	1.28	2540
2	#14	0.32	26	2.09	4128

分類： 製品規格	標準の名称： マルチ・インターロック・コネクタ(M.I.C)	標準のコード： 108-5099	改訂 E ₁	13 15 頁
-------------	-----------------------------------	---------------------	----------------------	------------

9. 取扱い上の注意事項

9.1 圧着及び取扱い

ハウジングとコンタクトの保持性能及びコネクタの接触性能を維持するため、コンタクトの圧着は「マルチ・インターロック・コネクタ・コンタクト圧着条件 114-5004 及び 114-5018」に基づいて作業を行なうこと。

9.2 ハーネス作業上

コネクタ同志の嵌合性能及び諸性能を維持するため、電線のテーピングは才 8 図の範囲にとどめる。

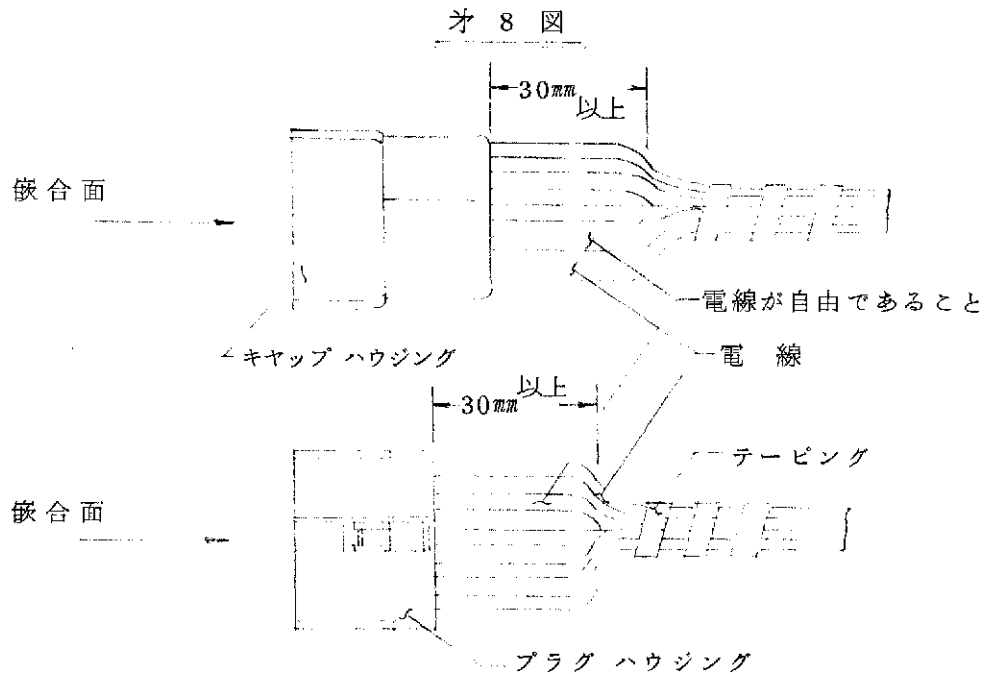

9.3 工 具

コンタクトの圧着及びハウジングからコンタクトを引き抜く場合は、AMP 指定の引抜工具を使用すること。

(引抜工具の取扱い説明書は No. IS-034J)

9.4 コネクタ引抜き作業

コネクタを引抜く際は、電線およびコンタクトの損傷を防ぐため、原則としてハウジングを持って引抜くこと。

但し、電線を持って引抜く場合は 3 本以上を持って行なうこと。

分類：	標準の名称：	標準のコード：	改訂	14
製品規格	マルチ・インターロック・コネクタ(M.I.C)	108-5099)	E1	15 頁

10. 参考規格

JASO D 605	:	「自動車用多極コネクタ」
JASO 7101	:	「プラスチック成形部品の試験方法」
JIS C 3406	:	「自動車用低圧電線」
JIS D 0203	:	「自動車部品の耐湿および耐水試験方法」
JIS D 0204	:	「自動車部品の高温および低温試験方法」
JIS D 1601	:	「自動車部品振動試験方法」
JIS R 5210	:	「ポルトランドセメント」
JIS C 5028	:	「電子機器用部品の塩水噴霧試験方法」
JIS D 5500	:	「自動車用ランプ類」
114 - 5004	:	「マルチ・インターロック・コネクタ・コンタクト圧着条件」
114 - 5018	:	「マルチ・インターロック・コネクタ・コンタクト圧着条件」

分類：	製品規格	標準の名称：	マルチ・インターロック・コネクタ(M.I.C)	標準のコード：	108-5099	改訂	E1	15	15	頁
-----	------	--------	-------------------------	---------	----------	----	----	----	----	---