

EVALUATION KIT
AVAILABLE**MAXIM**

Low-Cost RF Up/Downconverter with LNA and PA Driver

MAX2411A

General Description

The MAX2411A performs the RF front-end transmit/receive function in time-division-duplex (TDD) communication systems. It operates over a wide frequency range and is optimized for RF frequencies around 1.9GHz. Applications include most popular cordless and PCS standards. The MAX2411A includes a low-noise amplifier (LNA), a downconverter mixer, a local-oscillator buffer, an upconverter mixer, and a variable-gain power-amplifier (PA) driver in a low-cost, plastic surface-mount package. The MAX2411A's unique bidirectional, differential IF port reduces cost and component count by allowing the transmit and receive paths to share the same IF filter.

The LNA has a 2.4dB typical noise figure and a -10dBm input third-order intercept point (IP3). The downconverter mixer has a low 9.2dB noise figure and 4dBm input IP3. Image and local-oscillator filtering are implemented off-chip for maximum flexibility. The PA driver amplifier has 15dB of gain, which can be reduced over a 35dB range. Power consumption is only 60mW in receive mode and 90mW in transmit mode and drops to less than 3 μ W in shutdown mode.

For applications requiring separate, single-ended IF input and output ports, refer to the MAX2410 data sheet. For applications requiring only a receive function, Maxim offers a low-cost downconverter with LNA (see the MAX2406 data sheet).

Applications

PWT1900	DECT
DCS1800/PCS1900	ISM-Band Transceivers
PHS/PACS	Iridium Handsets

Typical Operating Circuit appears on last page.

Functional Diagram

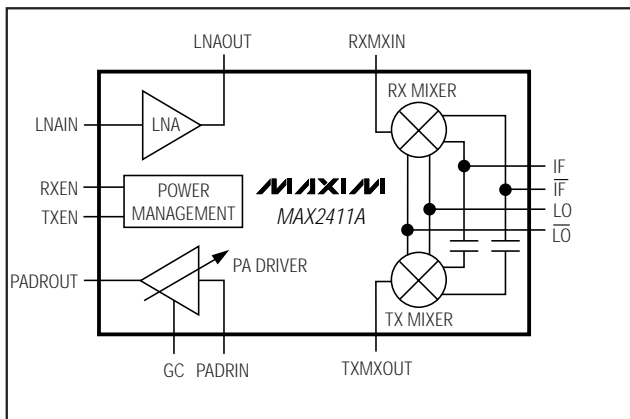

Features

- ◆ **Low-Cost Silicon Bipolar Design**
- ◆ **Integrated Upconvert/Downconvert Function**
- ◆ **Operates from a Single +2.7V to +5.5V Supply**
- ◆ **3.2dB Combined Receiver Noise Figure:**
2.4dB (LNA)
9.2dB (mixer)
- ◆ **Flexible Power-Amplifier Driver:**
18dBm Output Third-Order Intercept (OIP3)
35dB Gain-Control Range
- ◆ **LO Buffer for Low LO Drive Level**
- ◆ **Low Power Consumption:**
60mW Receive
90mW Full-Power Transmit
- ◆ **0.3 μ W Shutdown Mode**
- ◆ **Flexible Power-Down Modes Compatible with MAX2510/MAX2511 IF Transceivers**

Ordering Information

PART	TEMP. RANGE	PIN-PACKAGE
MAX2411AEEI	-40°C to +85°C	28 QSOP
MAX2411AE/D	-40°C to +85°C	Dice*

*Dice are specified at $T_A = 25^\circ\text{C}$, DC parameters only.

Pin Configuration

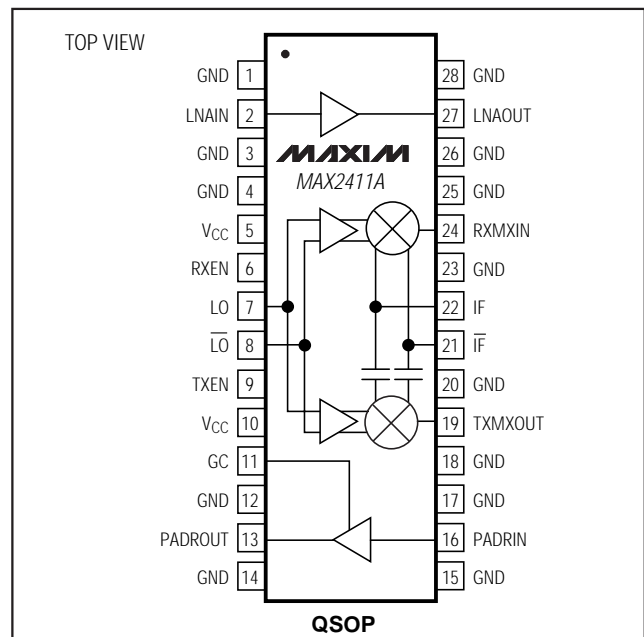
**MAXIM**

Maxim Integrated Products 1

For free samples & the latest literature: <http://www.maxim-ic.com>, or phone 1-800-998-8800.
For small orders, phone 408-737-7600 ext. 3468.

Low-Cost RF Up/Downconverter with LNA and PA Driver

ABSOLUTE MAXIMUM RATINGS

V _{CC} to GND	-0.3V to 6V
LNAIN Input Power	15dBm
LO, $\overline{\text{LO}}$ Input Power	10dBm
PADRIN Input Power	10dBm
RXMXIN Input Power	10dBm
IF, $\overline{\text{IF}}$ Input Power (transmit mode)	10dBm
Voltage at RXEN, TXEN, GC	-0.3V to (V _{CC} + 0.3V)

Continuous Power Dissipation (T _A = +70°C)	
QSOP (derate 11mW/°C above +70°C)	909mW
Junction Temperature	+150°C
Operating Temperature Range	-40°C to +85°C
Storage Temperature	-65°C to +165°C
Lead Temperature (soldering, 10sec)	+300°C

Stresses beyond those listed under "Absolute Maximum Ratings" may cause permanent damage to the device. These are stress ratings only, and functional operation of the device at these or any other conditions beyond those indicated in the operational sections of the specifications is not implied. Exposure to absolute maximum rating conditions for extended periods may affect device reliability.

DC ELECTRICAL CHARACTERISTICS

(V_{CC} = +2.7V to +5.5V, V_{GC} = +3.0V, RXEN = TXEN = 0.6V, PADROUT pulled up to V_{CC} with 50Ω resistor; IF, $\overline{\text{IF}}$ pulled up to V_{CC} with 50Ω resistor, TXMXOUT pulled up to V_{CC} with 125Ω resistor, LNAOUT pulled up to V_{CC} with 100Ω resistor, all RF inputs open, T_A = -40°C to +85°C. Typical values are at +25°C and V_{CC} = +3.0V, unless otherwise noted.)

PARAMETER	CONDITIONS	MIN	TYP	MAX	UNITS
Supply-Voltage Range		2.7		5.5	V
Digital Input Voltage High	RXEN, TXEN pins	2.0			V
Digital Input Voltage Low	RXEN, TXEN pins			0.6	V
RXEN Input Bias Current (Note 1)	RXEN = 2.0V		0.1	1	μA
TXEN Input Bias Current (Note 1)	TXEN = 2.0V		0.1	1	μA
GC Input Bias Current	GC = 3V, TXEN = 2V		35	51.1	μA
Supply Current, Receive Mode	RXEN = 2.0V		20	29.6	mA
Supply Current, Transmit Mode	TXEN = 2.0V		30	44.7	mA
Supply Current, Standby Mode	RXEN = 2.0V, TXEN = 2.0V		160	520	μA
Supply Current, Shutdown Mode	V _{CC} = 3.0V		0.1	10	μA

AC ELECTRICAL CHARACTERISTICS

(MAX2411A EV kit, V_{CC} = +3.0V, V_{GC} = +2.15V, RXEN = TXEN = low, all measurements performed in 50Ω environment, f_{LO} = 1.5GHz, P_{LO} = -10dBm, f_{LNAIN} = f_{PADRIN} = f_{RXMXIN} = 1.9GHz, P_{LNAIN} = -32dBm, P_{PADRIN} = P_{RXMXIN} = -22dBm, f_{IF}, $\overline{\text{IF}}$ = 400MHz, P_{IF} = -32dBm (Note 1), T_A = +25°C, unless otherwise noted.)

PARAMETER	CONDITIONS	MIN	TYP	MAX	UNITS
LOW-NOISE AMPLIFIER (RXEN = high)					
Gain (Note 2)	T _A = +25°C	14.2	16.2	17.4	dB
	T _A = T _{MIN} to T _{MAX}	12.6		19.1	
Noise Figure			2.4		dB
Input IP3	(Note 3)		-10		dBm
Output 1dB Compression			-5		dBm
LO to LNAIN Leakage	RXEN = high or low		-49		dBm
RECEIVE MIXER (RXEN = high)					
Conversion Gain (Note 2)	T _A = +25°C	8.5	9.4	10.0	dB
	T _A = -40°C to +85°C	7.5		10.9	
Noise Figure	Single sideband		9.2		dB
Input IP3	(Note 4)		4.0		dBm
Input 1dB Compression			-7.7		dBm
IF Frequency	(Notes 2, 5)			450	MHz
Minimum LO Drive Level	(Note 6)		-17		dBm

Low-Cost RF Up/Downconverter with LNA and PA Driver

MAX2411A

AC ELECTRICAL CHARACTERISTICS (continued)

(MAX2411A EV kit, $V_{CC} = +3.0V$, $V_{GC} = +2.15V$, $RXEN = TXEN = low$, all measurements performed in 50Ω environment, $f_{LO} = 1.5GHz$, $P_{LO} = -10dBm$, $f_{LNAIN} = f_{PADRIN} = f_{RXMXIN} = 1.9GHz$, $PLNAIN = -32dBm$, $PPADRIN = PRXMXIN = -22dBm$, $f_{IF} = 400MHz$, $P_{IF} = -32dBm$ (Note 1), all impedance measurements made directly to pin (no matching network), $T_A = +25^\circ C$, unless otherwise noted.)

PARAMETER	CONDITIONS	MIN	TYP	MAX	UNITS
TRANSMIT MIXER (TXEN = high)					
Conversion Gain (Note 1)	$T_A = +25^\circ C$	6.8	8.5	9.3	dB
	$T_A = T_{MIN}$ to T_{MAX}	5.7		10.4	
Output IP3	(Notes 1, 7)		0.5		dBm
Output 1dB Compression Point			-11.1		dBm
LO Leakage			-58		dBm
Noise Figure	Single sideband		8.3		dB
IF Frequency	(Notes 2, 5)			450	MHz
Intermod Spurious Response (Note 8)	$F_{OUT} = 2LO - 2IF = 2.2GHz$		-45.5		dBc
	$F_{OUT} = 2LO - 3IF = 1.8GHz$		-70		
	$F_{OUT} = 3LO - 6IF = 2.1GHz$		-90		
PA DRIVER (TXEN = high)					
Gain (Note 2)	$T_A = +25^\circ C$	13	15	16.4	dB
	$T_A = T_{MIN}$ to T_{MAX}	12.3		17	
Output IP3	(Note 4)		18		dBm
Output 1dB Compression Point			6.3		dBm
Gain-Control Range			35		dB
Gain-Control Sensitivity	(Note 9)		12		dB/V
LOCAL-OSCILLATOR INPUTS (RXEN = TXEN = high)					
Input Relative VSWR	Receive mode (TXEN = low)		1.10		
	Transmit mode (RXEN = low)		1.02		
POWER MANAGEMENT (RXEN = TXEN = low)					
Receiver Turn-On Time (Notes 2, 10)	RXEN = low to high		0.5	2.5	μs
Transmitter Turn-On Time (Notes 2, 11)	TXEN = low to high		0.3	2.5	μs

Note 1: Power delivered to IF SMA connector of MAX2411A EV kit. Power delivered to MAX2411A IC is approximately 1.0dB less due to balun losses.

Note 2: Guaranteed by design and characterization.

Note 3: Two tones at 1.9GHz and 1.901GHz at -32dBm per tone.

Note 4: Two tones at 1.9GHz and 1.901GHz at -22dBm per tone.

Note 5: Mixer operation guaranteed to this frequency. For optimum gain, adjust output match. See the *Typical Operating Characteristics* for graphs of IF port impedance versus IF frequency.

Note 6: At this LO drive level, the mixer conversion gain is typically 1dB lower than with -10dBm LO drive.

Note 7: Two tones at 400MHz and 401MHz at -32dBm per tone.

Note 8: Transmit mixer output at -17dBm.

Note 9: Calculated from measurements taken at $V_{GC} = 1.0V$ and $V_{GC} = 1.5V$.

Note 10: Time from RXEN = low to RXEN = high transition until the combined receive gain is within 1dB of its final value. Measured with 47pF blocking capacitors on LNAIN and LNAOUT.

Note 11: Time from TXEN = low to TXEN = high transition until the combined transmit gain is within 1dB of its final value. Measured with 47pF blocking capacitors on PADRIN and PADROUT.

Low-Cost RF Up/Downconverter with LNA and PA Driver

Typical Operating Characteristics

(MAX2411A EV kit, $V_{CC} = +3.0V$, $V_{GC} = +2.15V$, $RXEN = TXEN = \text{low}$, all measurements performed in 50Ω environment, $f_{LO} = 1.5GHz$, $P_{LO} = -10dBm$, $f_{LNAIN} = f_{PADRIN} = f_{RXMXIN} = 1.9GHz$, $P_{LNAIN} = -32dBm$, $P_{PADRIN} = P_{RXMXIN} = -22dBm$, $f_{IF} = 400MHz$, $P_{IF} = -32dBm$ (Note 1), all impedance measurements made directly to pin (no matching network), $T_A = +25^\circ C$, unless otherwise noted.)

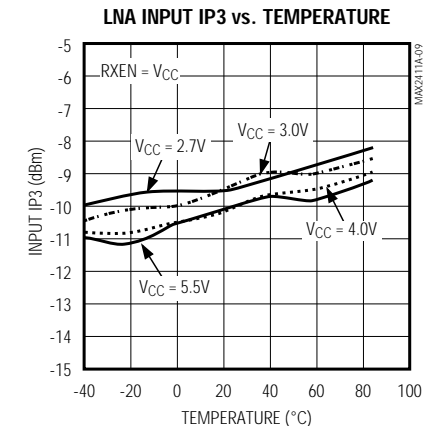
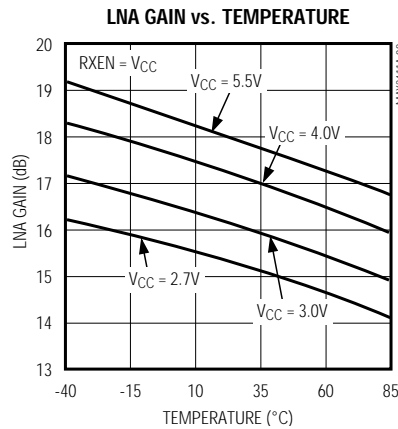
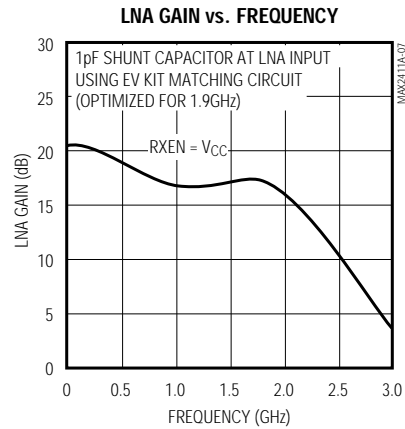
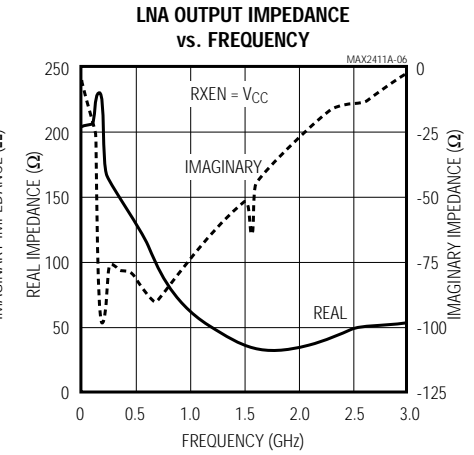
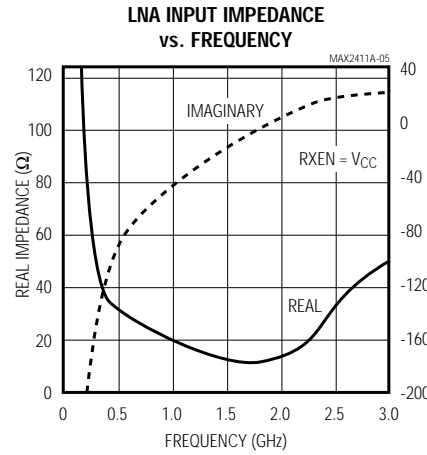
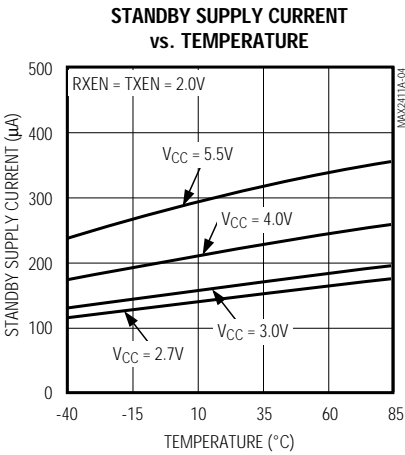
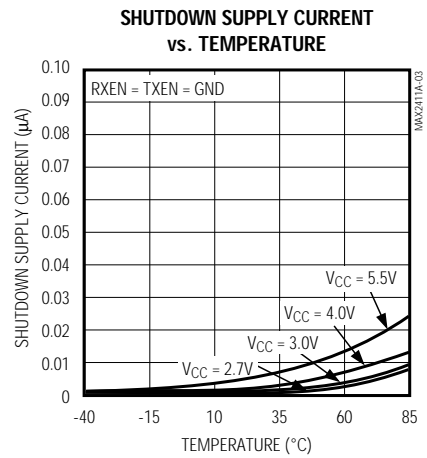
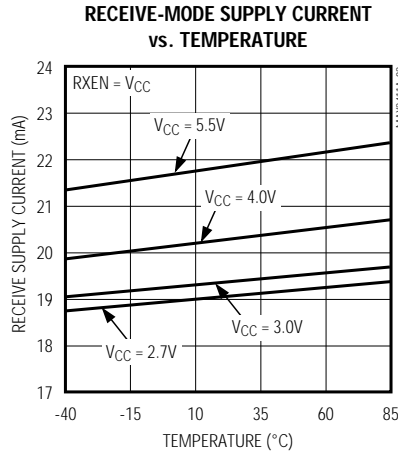
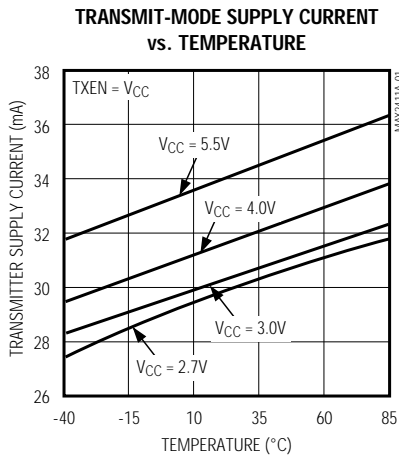

Low-Cost RF Up/Downconverter with LNA and PA Driver

MAX2411A

Typical Operating Characteristics (continued)

(MAX2411A EV kit, $V_{CC} = +3.0V$, $V_{GC} = +2.15V$, $R_{XEN} = TXEN = \text{low}$, all measurements performed in 50Ω environment, $f_{LO} = 1.5GHz$, $P_{LO} = -10dBm$, $f_{LNAIN} = f_{PADRIN} = f_{RXMXIN} = 1.9GHz$, $P_{LNAIN} = -32dBm$, $P_{PADRIN} = P_{RXMXIN} = -22dBm$, $f_{IF} = 400MHz$, $P_{IF} = -32dBm$ (Note 1), all impedance measurements made directly to pin (no matching network), $T_A = +25^\circ C$, unless otherwise noted.)

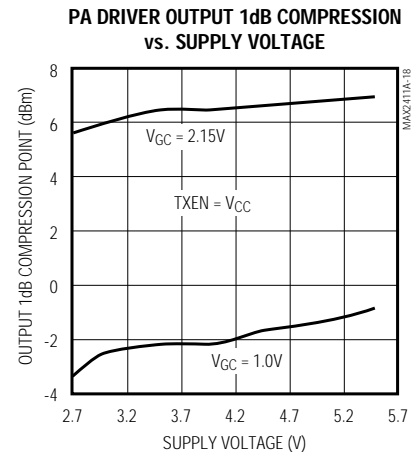
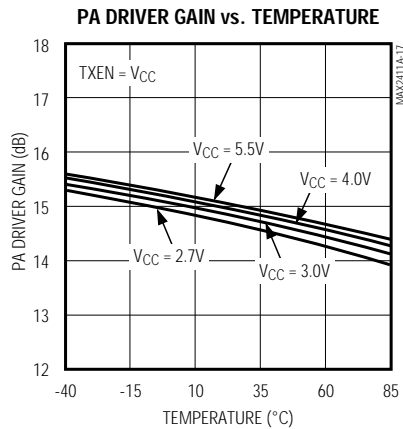
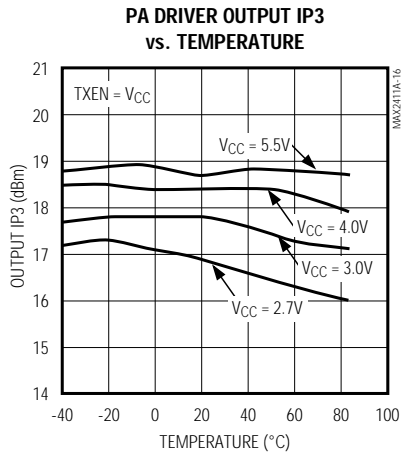
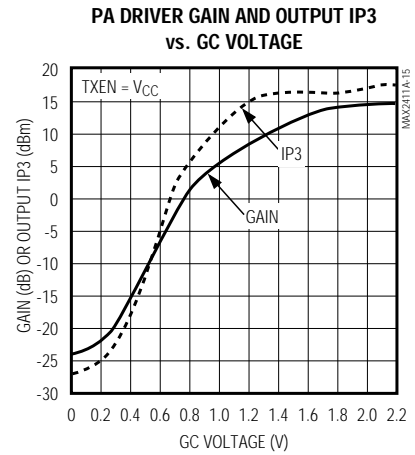
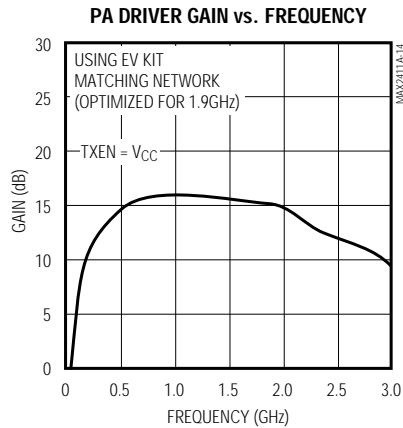
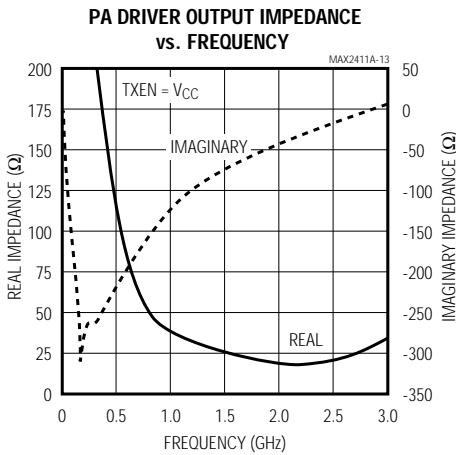
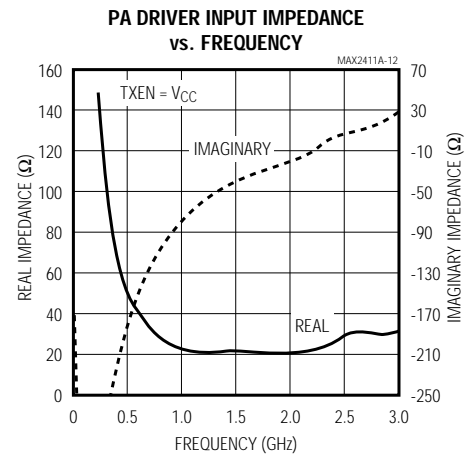
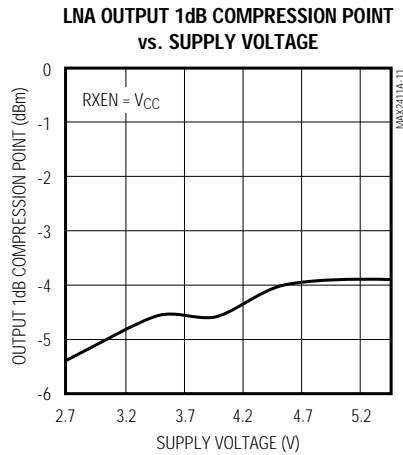
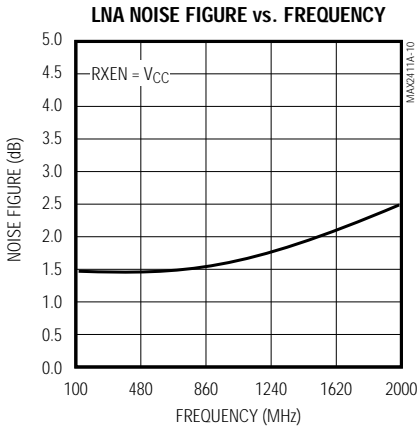

Low-Cost RF Up/Downconverter with LNA and PA Driver

Typical Operating Characteristics (continued)

(MAX2411A EV kit, $V_{CC} = +3.0V$, $V_{GC} = +2.15V$, $RXEN = TXEN = low$, all measurements performed in 50Ω environment, $f_{LO} = 1.5GHz$, $P_{LO} = -10dBm$, $f_{LNAIN} = f_{PADRIN} = f_{RXMXIN} = 1.9GHz$, $P_{LNAIN} = -32dBm$, $P_{PADRIN} = P_{RXMXIN} = -22dBm$, $f_{IF} = 400MHz$, $P_{IF} = -32dBm$ (Note 1), all impedance measurements made directly to pin (no matching network), $T_A = +25^\circ C$, unless otherwise noted.)

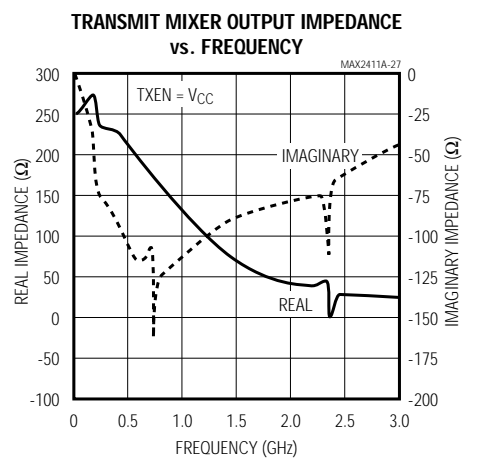
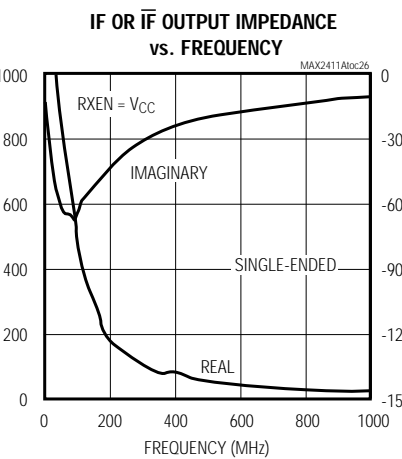
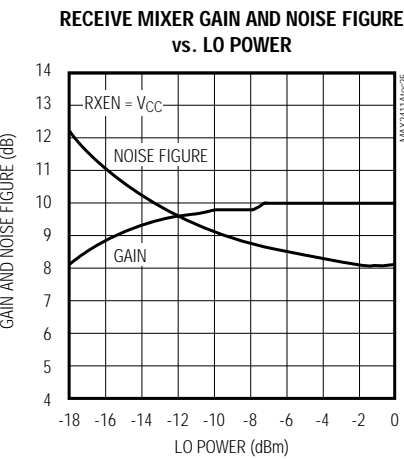
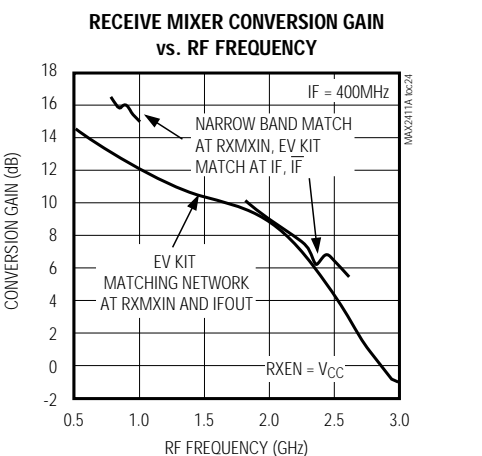
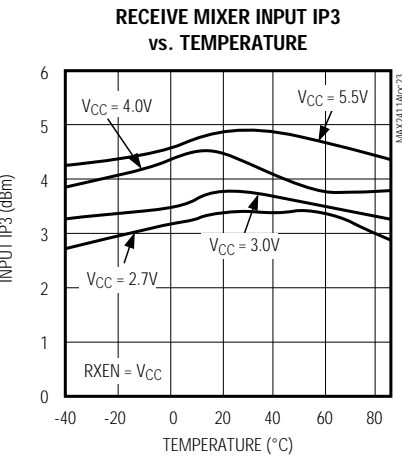
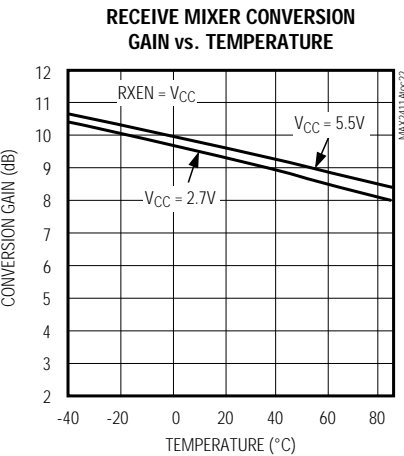
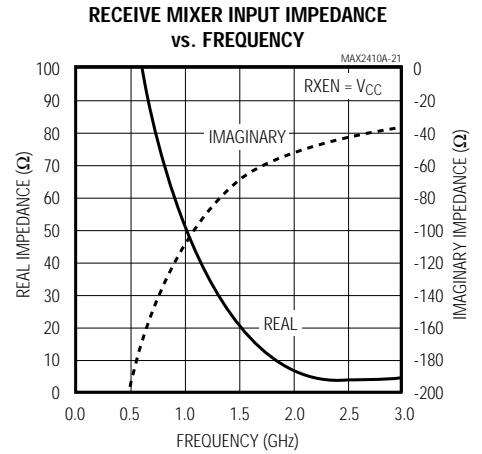
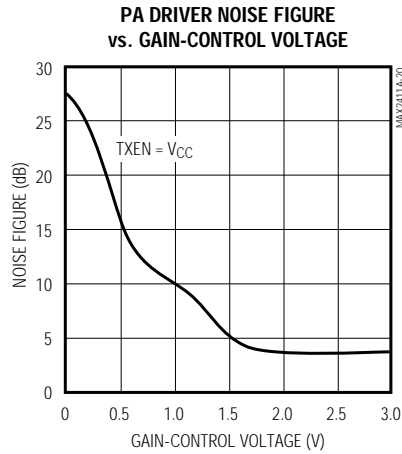
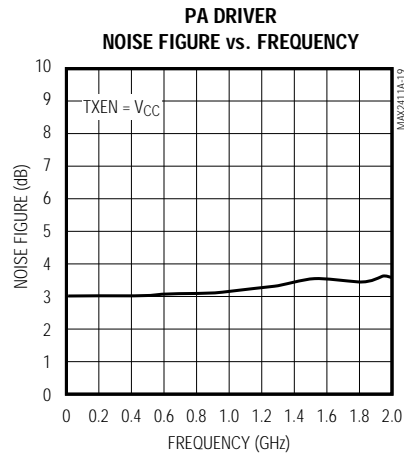

Low-Cost RF Up/Downconverter with LNA and PA Driver

MAX2411A

Typical Operating Characteristics (continued)

(MAX2411A EV kit, $V_{CC} = +3.0V$, $V_{GC} = +2.15V$, $RXEN = TXEN = \text{low}$, all measurements performed in 50Ω environment, $f_{LO} = 1.5GHz$, $P_{LO} = -10dBm$, $f_{LNAIN} = f_{PADRIN} = f_{RXMXIN} = 1.9GHz$, $P_{LNAIN} = -32dBm$, $P_{PADRIN} = P_{RXMXIN} = -22dBm$, $f_{IF} = 400MHz$, $P_{IF} = -32dBm$ (Note 1), all impedance measurements made directly to pin (no matching network), $T_A = +25^\circ C$, unless otherwise noted.)

TRANSMIT MIXER CONVERSION GAIN vs. TEMPERATURE

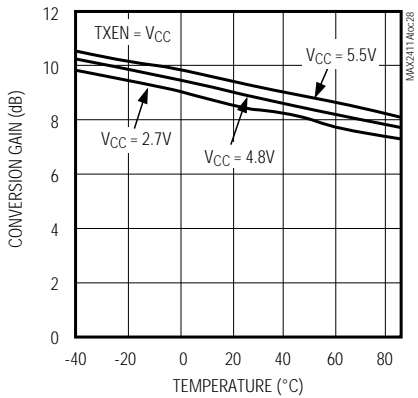

TRANSMIT MIXER CONVERSION GAIN vs. RF FREQUENCY

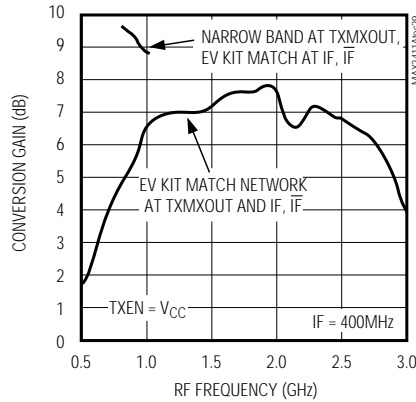

TRANSMIT MIXER OUTPUT IP3 vs. TEMPERATURE

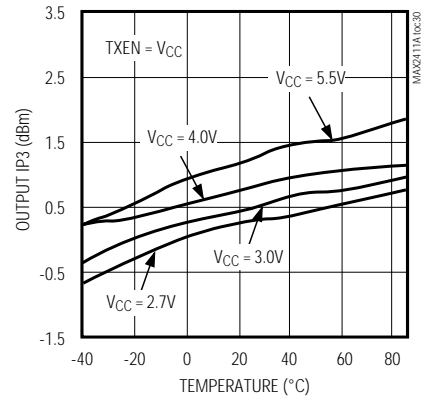

TRANSMIT MIXER GAIN AND NOISE FIGURE vs. LO POWER

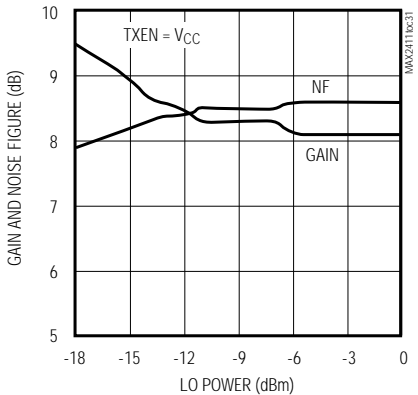

IF OR IF OUTPUT IMPEDANCE vs. FREQUENCY

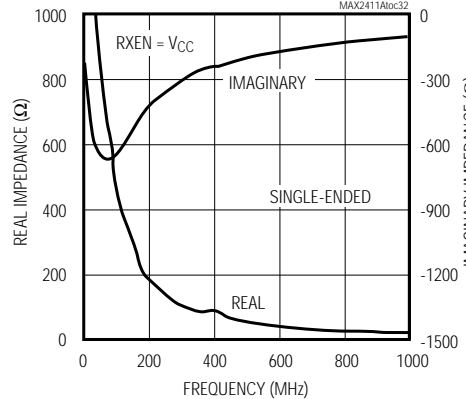

LO PORT RETURN LOSS vs. FREQUENCY

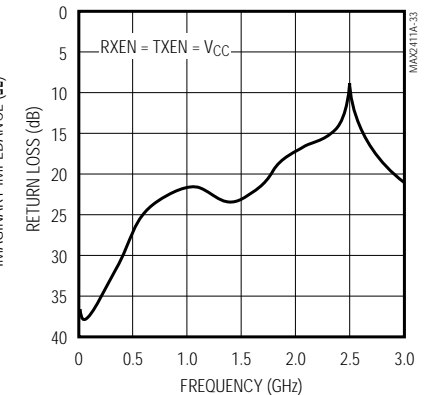

Low-Cost RF Up/Downconverter with LNA and PA Driver

MAX2411A

Pin Description

PIN	NAME	FUNCTION
1, 3, 4, 12, 14, 18, 20, 23, 28	GND	Ground. Connect GND to the PC board ground plane with minimal inductance.
2	LNAIN	RF Input to LNA. AC couple to this pin. At 1.9GHz, LNAIN can be easily matched to 50Ω with one external shunt 1pF capacitor.
5, 10	V _{CC}	Supply Voltage (2.7V to 5.5V). Bypass V _{CC} to GND at each pin with a 47pF capacitor as close to each pin as possible.
6	RXEN	Logic-Level Enable for Receiver Circuitry. A logic high turns on the receiver. When TXEN and RXEN are both at a logic high, the part is placed in standby mode, with a 160μA (typical) supply current. If TXEN and RXEN are both at a logic low, the part is set to shutdown mode, with a 0.1μA (typical) supply current.
7	LO	50Ω Local-Oscillator (LO) Input Port. AC couple to this pin.
8	$\overline{\text{LO}}$	50Ω Inverting Local-Oscillator Input Port. For single-ended operation, connect $\overline{\text{LO}}$ directly to GND. If a differential LO signal is available, AC couple the inverted LO signal to this pin.
9	TXEN	Logic-Level Enable for Transmitter Circuitry. A logic high turns on the transmitter. When TXEN and RXEN are both at a logic high, the part is placed in standby mode, with a 160μA (typical) supply current. If TXEN and RXEN are both at a logic low, the part is set to shutdown mode, with a 0.1μA (typical) supply current.
11	GC	Gain-Control Input for PA Driver. By applying an analog control voltage between 0V and 2.15V, the gain of the PA driver can be adjusted over a 35dB range. Connect to V _{CC} for maximum gain.
13	PADROUT	Power Amplifier Driver Output. AC couple to this pin. Use external shunt inductor to V _{CC} to match PADROUT to 50Ω. This also provides DC bias. See the <i>Typical Operating Characteristics</i> for a plot of PADROUT Impedance vs. Frequency.
15, 17	GND	PA Driver Input Grounds. Connect GND to the PC board ground plane with minimal inductance.
16	PADRIN	RF Input to Variable-Gain Power Amplifier Driver. Internally matched to 50Ω. AC couple to this pin. This input typically provides a 2:1 VSWR at 1.9GHz. AC couple to this pin. See the <i>Typical Operating Characteristics</i> for a plot of PADRIN Impedance vs. Frequency.
19	TXMXOUT	RF Output of Transmit Mixer (upconverter). Use an external shunt inductor to V _{CC} as part of a matching network to 50Ω. This also provides DC bias. AC couple to this pin. See the <i>Typical Operating Characteristics</i> for a plot of TXMXOUT Impedance vs. Frequency.
21	$\overline{\text{IF}}$	Differential IF Port of Transmit (Tx) and Receive (Rx) Mixers, Inverting Side. In Rx mode, this output is an open collector and should be pulled up to V _{CC} with an inductor. This inductor can be part of the matching network to the desired IF impedance in both Tx and Rx modes. Additionally, a resistor may be placed across IF and $\overline{\text{IF}}$ to set a terminating impedance. In Tx mode, this input is internally AC-coupled; however, AC couple to this pin externally. For single-ended operation, connect this port to V _{CC} and bypass with 1000pF capacitor to GND.
22	IF	Differential IF Port of Tx and Rx Mixers, Noninverting Side. In Rx mode, this output is an open collector and should be pulled up to V _{CC} with an inductor. This inductor can be part of the matching network to the desired IF impedance in both Tx and Rx modes. Additionally, a resistor may be placed across IF and $\overline{\text{IF}}$ to set a terminating impedance. In Tx mode, this input is internally AC coupled; however, AC couple to this pin externally.

Low-Cost RF Up/Downconverter with LNA and PA Driver

Pin Description (continued)

MAX2411A

PIN	NAME	FUNCTION
24	RXXMIXIN	RF Input to Receive Mixer (downconverter). This input typically requires a matching network for connecting to an external filter. AC couple to this pin. See the <i>Typical Operating Characteristics</i> for a plot of RXXMIXIN Impedance vs. Frequency.
25	GND	Receive Mixer Input Ground. Connect GND to the PC board ground plane with minimal inductance.
26	GND	LNA Output Ground. Connect GND to the PC board ground plane with minimal inductance.
27	LNAOUT	LNA Output. AC couple to this pin. This output typically provides a VSWR of better than 2:1 at frequencies from 1.7GHz to 3GHz with no external matching components. At other frequencies, a matching network may be required to match LNAOUT to an external filter. Consult the <i>Typical Operating Characteristics</i> for a plot of LNA Output Impedance vs. Frequency.

Detailed Description

The MAX2411A consists of five major components: a transmit mixer followed by a variable-gain power-amplifier (PA) driver as well as a low-noise amplifier (LNA), receive mixer, and power-management section.

The following sections describe each of the blocks in the MAX2411A *Functional Diagram*.

Low-Noise Amplifier (LNA)

The LNA is a wideband, single-ended cascode amplifier that can be used over a wide range of frequencies. Refer to the LNA Gain vs. Frequency graph in the *Typical Operating Characteristics*. Its port impedances are optimized for operation around 1.9GHz, requiring only a 1pF shunt capacitor at the LNA input for a VSWR of better than 2:1 and a noise figure of 2.4dB. As with every LNA, the input match can be traded off for better noise figure.

PA Driver

The PA driver has typically 15dB of gain, which is adjustable over a 35dB range via the GC pin. At full gain, the PA driver has a noise figure of 3.5dB at 1.9GHz.

For input and output matching information, refer to the *Typical Operating Characteristics* for plots of PA Driver Input and Output Impedance vs. Frequency.

Bidirectional IF Port

The MAX2411A has a unique bidirectional differential IF port, which can eliminate the need for separate transmit and receive IF filters, reducing cost and component count. Consult the *Typical Operating Circuit* for more information. For single-ended operation, connect the unused $\overline{\text{IF}}$ port to VCC and bypass with a 1000pF capacitor to GND.

In receive mode, the IF and $\overline{\text{IF}}$ pins are open-collector outputs that need external inductive pull-ups to VCC for

proper operation. These inductors are typically used as part of an IF matching network.

In transmit mode, IF and $\overline{\text{IF}}$ are high-impedance inputs that are internally AC coupled to the transmit mixer. This internal AC coupling prevents the DC bias voltage required for the receive mixer outputs from reaching the transmit mixer inputs.

Receive Mixer

The receive mixer is a wideband, double-balanced design with excellent noise figure and linearity. Inputs to the mixer are the RF signal at the RXXMIXIN pin and the LO inputs at LO and $\overline{\text{LO}}$. The downconverted output signal appears at the IF port. For more information, see the *Bidirectional IF Port* section. The conversion gain of the receive mixer is typically 9.4dB with a 9.2dB noise figure.

RF Input

The RXXMIXIN input is typically connected to the LNA output through an off-chip filter. This input is externally matched to 50 Ω . See the *Typical Operating Circuit* for an example matching network and the Receive Mixer Input Impedance vs. Frequency graph in the *Typical Operating Characteristics*.

Local-Oscillator Inputs

The LO and $\overline{\text{LO}}$ pins are internally terminated with 50 Ω on-chip resistors. AC couple the local-oscillator signal to these pins. If a single-ended LO source is used, connect $\overline{\text{LO}}$ directly to ground.

Transmit Mixer

The transmit mixer takes an IF signal at the IF port and upconverts it to an RF frequency at the TXMXOUT pin. For more information on the IF port, see the *Bidirectional IF Port* section. The conversion gain is typically 8.5dB, and the output 1dB compression point is typically 11.1dBm at 1.9GHz.

Low-Cost RF Up/Downconverter with LNA and PA Driver

RF Output

The transmit mixer output appears on the TXMXOUT pin, an open-collector output that requires an external pull-up inductor for DC biasing, which can be part of an impedance matching network. Consult the *Typical Operating Characteristics* for a plot of TXMXOUT Impedance vs. Frequency.

Advanced System Power Management

RXEN and TXEN are the two separate power-control inputs for the receiver and transmitter. If both inputs are at logic 0, the part enters shutdown mode, and the supply current drops below 1 μ A. When one input is brought to logic 1, the corresponding function is enabled. If RXEN and TXEN are both set to logic 1, the part enters standby mode, as described in the *Standby Mode* section. Table 1 summarizes these operating modes.

Power-down is guaranteed with a control voltage at or below 0.6V. The power-down function is designed to reduce the total power consumption to less than 1 μ A in less than 2.5 μ s. Complete power-up happens in the same amount of time.

Standby Mode

When the TXEN and RXEN pins are both set to logic 1, all functions are disabled, and the supply current drops to 160 μ A (typ); this mode is called Standby. This mode corresponds to a standby mode on the compatible IF transceiver chips MAX2510 and MAX2511.

Applications Information

Extended Frequency Range

The MAX2411A has been characterized at 1.9GHz for use in PCS-band applications. However, it operates over a much wider frequency range. The LNA gain and noise figure, PA driver gain, and mixer conversion gain are plotted over a wide frequency range in the *Typical Operating Characteristics*. When operating the device

Table 1. Advanced System Power-Management Function

RXEN	TXEN	FUNCTION
0	0	Shutdown
0	1	Transmit
1	0	Receive
1	1	Standby mode

at RF frequencies other than those specified in the *AC Electrical Characteristics* table, it may be necessary to design or alter the matching networks on the RF ports. If the IF frequency is different from that specified in the *AC Electrical Characteristics* table, the IF, \overline{IF} matching network must also be altered. The *Typical Operating Characteristics* provide port impedance data versus frequency on all RF and IF ports for use in designing matching networks. The LO port (LO and \overline{LO}) is internally terminated with 50 Ω resistors and provides a VSWR of approximately 1.2:1 to 2GHz and 2:1 up to 3GHz.

Layout Issues

A properly designed PC board is essential to any RF/microwave circuit. Be sure to use controlled impedance lines on all high-frequency inputs and outputs. Use low-inductance connections to ground on all GND pins, and place decoupling capacitors close to all VCC connections.

For the power supplies, a star topology works well. Each VCC node in the circuit has its own path to the central VCC and a decoupling capacitor that provides a low impedance at the RF frequency of interest. The central VCC node has a large decoupling capacitor as well. This provides good isolation between the different sections of the MAX2411A. The MAX2411A EV kit layout can be used as a guide to integrating the MAX2411A into your design.

Low-Cost RF Up/Downconverter with LNA and PA Driver

Typical Application Block Diagram

MAX2411A

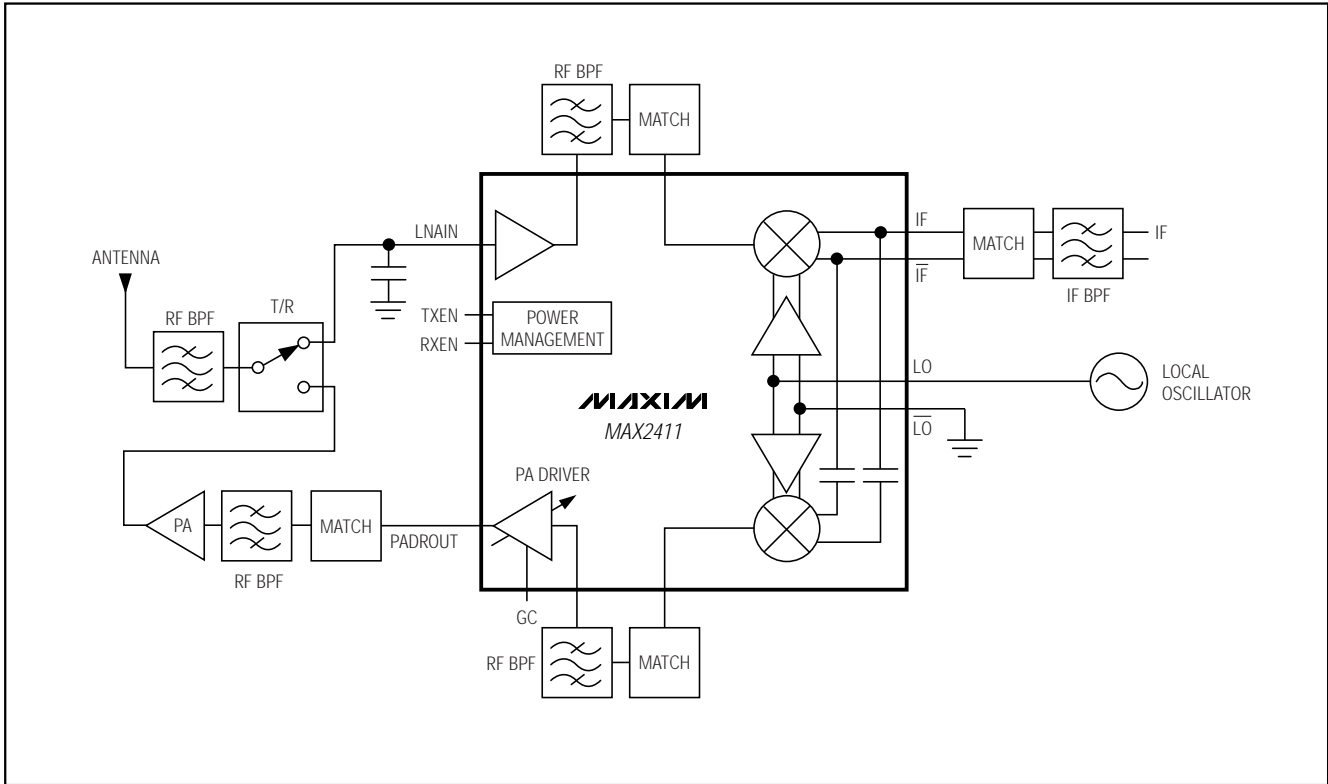

Low-Cost RF Up/Downconverter with LNA and PA Driver

Typical Operating Circuit

MAX2411A

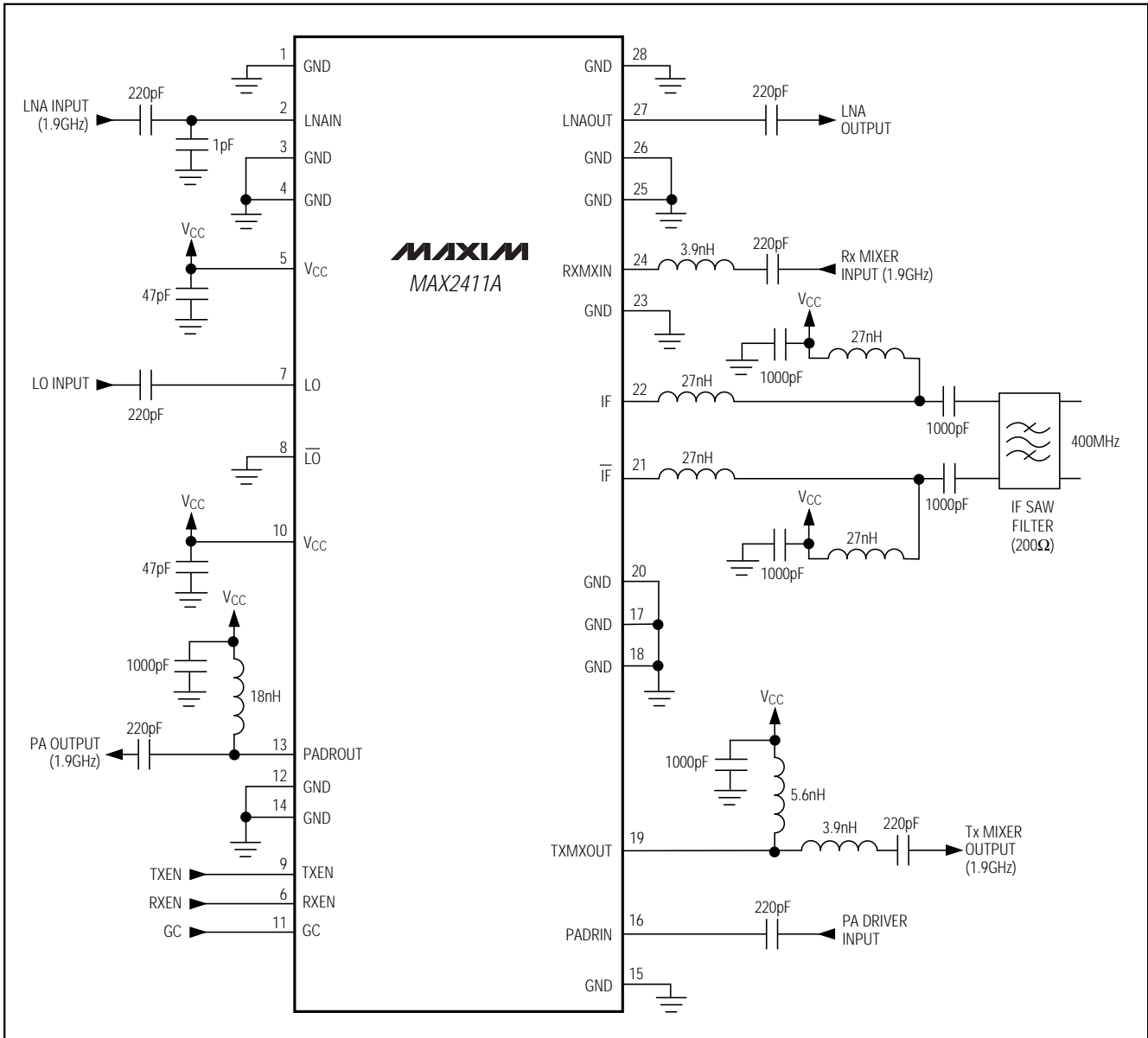

Low-Cost RF Up/Downconverter with LNA and PA Driver

Package Information

MAX2411A

OSOP, EPS

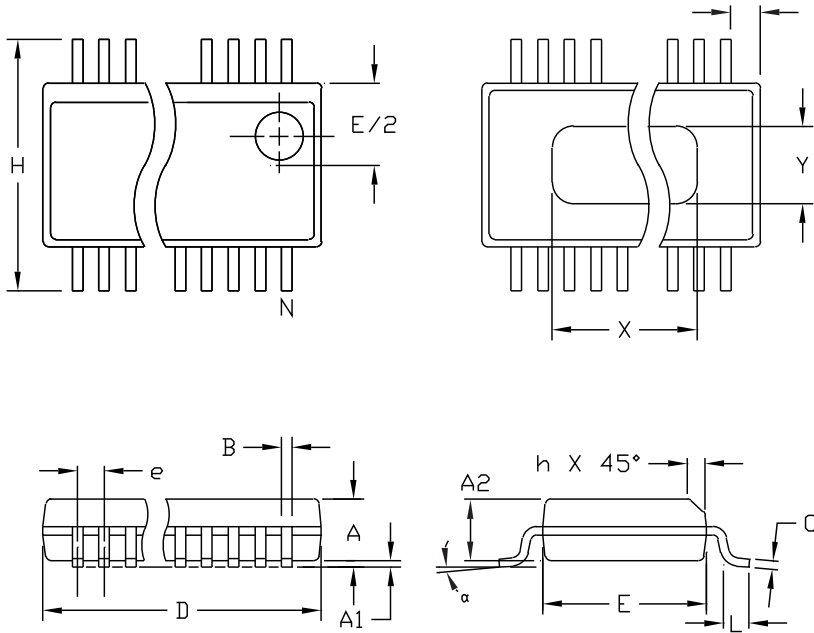

DIM	INCHES		MILLIMETERS	
	MIN	MAX	MIN	MAX
A	.061	.068	1.55	1.73
A1	.004	.0098	0.102	0.249
A2	.055	.061	1.40	1.55
B	.008	.012	0.20	0.31
C	.0075	.0098	0.191	0.249
D	SEE VARIATIONS			
E	.150	.157	3.81	3.99
e	.025 BSC		0.635 BSC	
H	2.30	2.44	5.84	6.20
h	.010	.016	0.25	0.41
L	.016	.035	0.41	0.89
N	SEE VARIATIONS			
X	SEE VARIATIONS			
Y	.071	.087	1.803	2.209
α	0°	8°	0°	8°

VARIATIONS:

	INCHES		MILLIMETERS		N
	MIN.	MAX.	MIN.	MAX.	
D	.189	.196	4.80	4.98	16 AA
S	.0020	.0070	0.05	0.18	
X	.107	.123	2.72	3.12	
D	.337	.344	8.56	8.74	20 AB
S	.0500	.0550	1.270	1.397	
D	.337	.344	8.56	8.74	24 AC
S	.0250	.0300	0.635	0.762	
D	.386	.393	9.80	9.98	28 AD
S	.0250	.0300	0.635	0.762	
X	.271	.287	6.88	7.29	

NOTES:

1. D & E DO NOT INCLUDE MOLD FLASH OR PROTRUSIONS
2. MOLD FLASH OR PROTRUSIONS NOT TO EXCEED .006" PER SIDE.
3. HEAT SLUG DIMENSIONS X AND Y APPLY ONLY TO 16 AND 28 LEAD POWER-QSOP PACKAGES.
4. CONTROLLING DIMENSIONS: INCHES.

MAXIM
 PROPRIETARY INFORMATION
 TITLE:
 PACKAGE OUTLINE, OSOP, .150", .025" LEAD PITCH
 APPROVAL: _____ DOCUMENT CONTROL NO: 21-0055 REV: B 1/1

Low-Cost RF Up/Downconverter with LNA and PA Driver

NOTES