

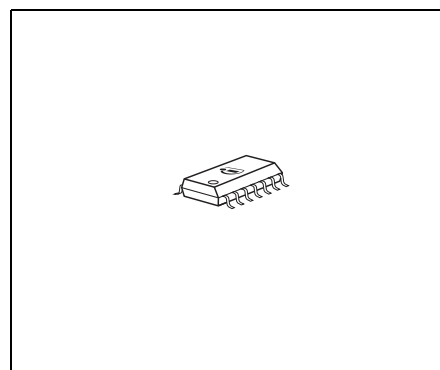

Features

- Output voltage tolerance $\leq \pm 2\%$
- 150 mA current capability
- Very low current consumption
- Early warning
- Reset output low down to $V_Q = 1\text{ V}$
- Overtemperature protection
- Reverse polarity proof
- Adjustable reset threshold
- Very low-drop voltage
- Wide temperature range
- Green Product (RoHS compliant)
- AEC Qualified

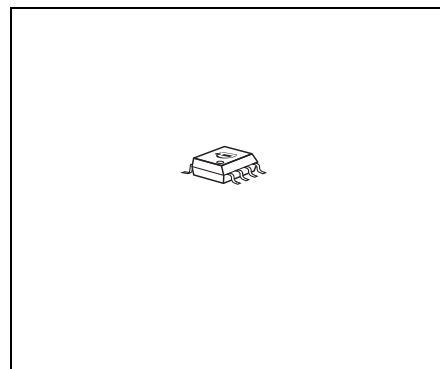

Functional Description

This device is an automotive suited voltage regulator with a fixed 5-V output, e.g. in a PG-DSO-8-16 package. The maximum operating voltage is 45 V. The output is able to drive 150 mA load. It is short circuit protected and the thermal shutdown switches the output off if the junction temperature is in excess of 150 °C. A reset signal is generated for an output voltage of $V_Q < 4.65\text{ V}$. The reset threshold voltage can be decreased by external connection of a voltage divider. The reset delay time can be set by an external capacitor. If the application requires pull-up resistors at the logic outputs (Reset, Sense Out) the TLE 4269 with integrated resistors can be used. It is also possible to supervise the input voltage by using an integrated comparator to give a low voltage warning.

Type	Package
TLE 4279 G	PG-DSO-8-16
TLE 4279 GM	PG-DSO-14-30

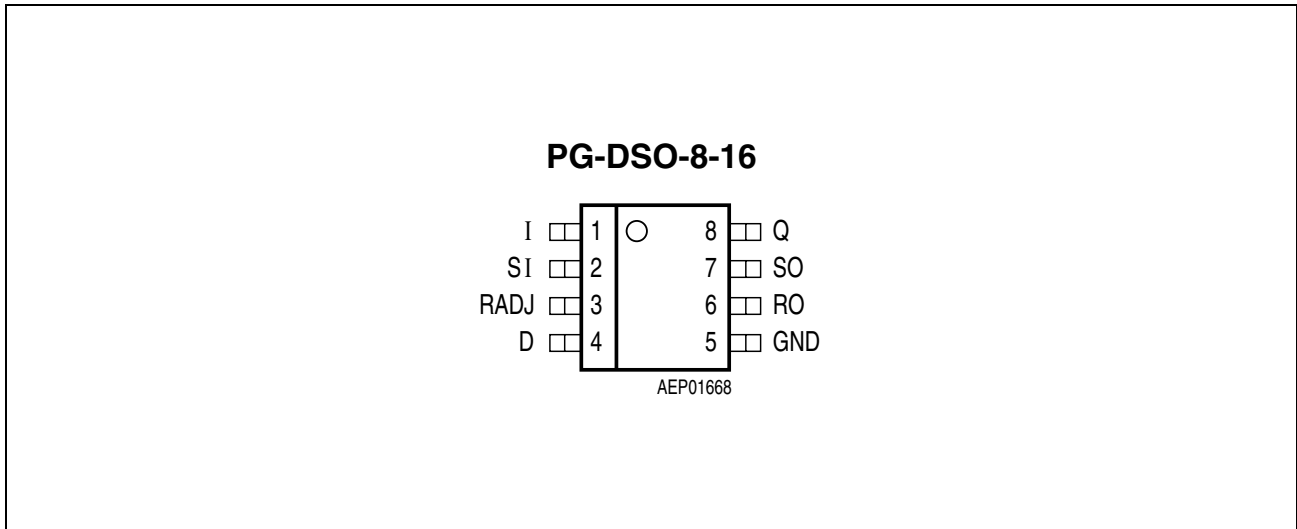

Figure 1 Pin Configuration (top view)

Table 1 Pin Definitions and Functions (TLE 4279 G)

Pin No.	Symbol	Function
1	I	Input; block to GND directly at the IC with a ceramic capacitor
2	SI	Sense input; if not needed connect to Q
3	RADJ	Reset threshold adjust; if not needed connect to ground
4	D	Reset delay; to select the delay time, connect to GND via external capacitor
5	GND	Ground
6	RO	Reset output; open-collector output. Keep open, if not needed
7	SO	Sense output; open-collector output. Keep open, if not needed
8	Q	5-V output; connect to GND with a 10 μ F capacitor, ESR < 10 Ω

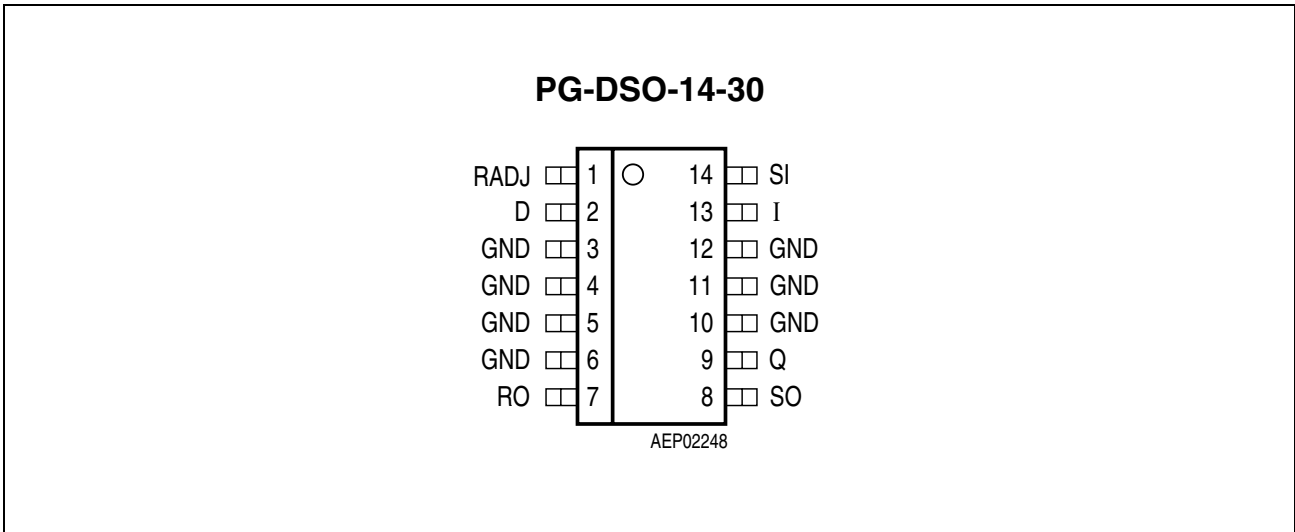

Figure 2 Pin Configuration (top view)

Table 2 Pin Definitions and Functions (TLE 4279 GM)

Pin No.	Symbol	Function
1	RADJ	Reset threshold adjust ; if not needed connect to GND
2	D	Reset delay ; connect to GND via external delay capacitor for setting delay time
3, 4, 5, 6	GND	Ground
7	RO	Reset output ; open-collector output. Keep open, if not needed
8	SO	Sense output ; open-collector output. Keep open, if not needed
9	Q	5-V output ; connect to GND via 10 μ F capacitor, ESR < 10 Ω
10, 11, 12	GND	Ground
13	I	Input ; block to GND directly at the IC by a ceramic capacitor
14	SI	Sense input ; if not needed connect to Q

Circuit Description

The control amplifier compares a reference voltage, made highly accurate by resistance balancing, with a voltage proportional to the output voltage and drives the base of the series PNP transistor via a buffer. Saturation control as a function of the load current prevents any over-saturation of the power element.

The reset output RO is in high-state if the voltage on the delay capacitor C_D is greater or equal V_{UD} . The delay capacitor C_D is charged with the current I_D for output voltages greater than the reset threshold V_{RT} . If the output voltage gets lower than V_{RT} ('reset condition') a fast discharge of the delay capacitor C_D sets in and as soon as V_D gets lower than V_{LD} the reset output RO is set to low-level.

The time gap for the delay capacitor discharge is the reset reaction time t_{RR} .

The reset threshold V_{RT} can be decreased via an external voltage divider connected to the pin RADJ. In this case the reset condition is reached if $V_Q < V_{RT}$ and $V_{RADJ} < V_{RAQDJ,TH}$. Dimensioning the voltage divider (see [Figure 4](#)) according to:

$$V_{THRES} = V_{RADJ,TH} \times (R_{RADJ1} + R_{RADJ2}) / R_{RADJ2}, \quad (1)$$

the reset threshold can be decreased down to 3.5 V. If the reset-adjust-option is not needed the RADJ-pin should be connected to GND causing the reset threshold to go to its default value (typ. 4.65 V).

A built in comparator compares the signal of the pin SI, normally fed by a voltage divider from the input voltage, with the reference and gives an early warning on the pin SO. It is also possible to supervise another voltage e.g. of a second regulator, or to build a watchdog circuit with few external components.

Application Description

The input capacitor C_1 is necessary for compensating line influences. Using a resistor of approx. 1 Ω in series with C_1 , the oscillating circuit consisting of input inductivity and input capacitance can be damped. The output capacitor C_Q is necessary for the stability of the regulating circuit. Stability is guaranteed at values $\geq 10 \mu\text{F}$ and an ESR $\leq 10 \Omega$ within the operating temperature range. Both reset output and sense output are open collector outputs and have to be connected to 5 V output via external pull-up resistors $\geq 10 \text{ k}\Omega$. For small tolerances of the reset delay the spread of the capacitance of the delay capacitor and its temperature coefficient should be noted.

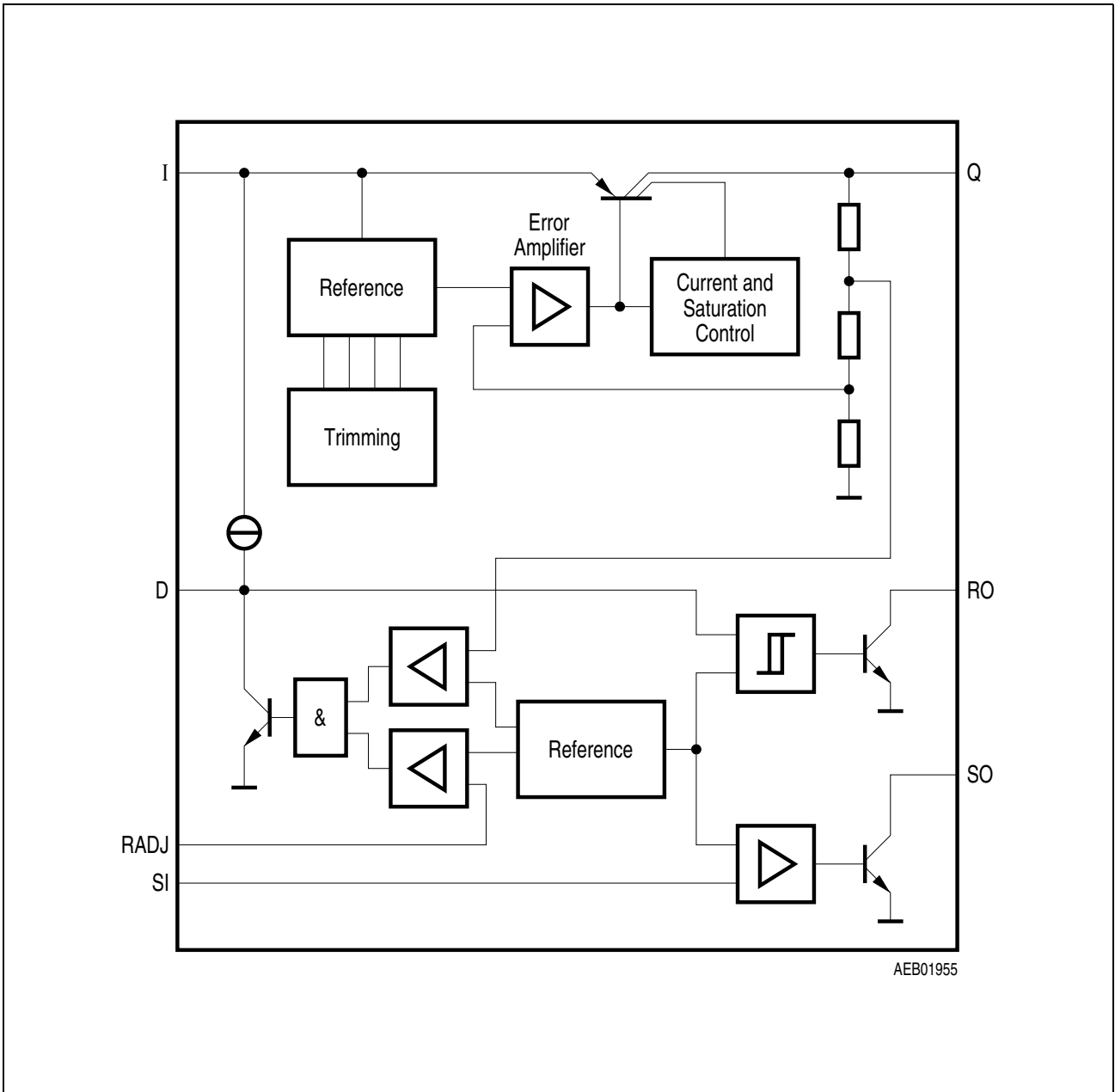

Figure 3 Block Diagram

Table 3 Absolute Maximum Ratings
 $T_j = -40$ to 150 °C

Parameter	Symbol	Limit Values		Unit	Notes
		Min.	Max.		
Input					
Input voltage	V_I	-40	45	V	–
Input current	I_I	–	–	–	internal limited
Sense Input					
Input voltage	V_{SI}	-40	45	V	–
Input current	I_{SI}	1	1	mA	–
Reset Threshold					
Voltage	V_{RADJ}	-40	7	V	–
Current	I_{RADJ}	-10	10	mA	–
Reset Delay					
Voltage	V_D	-0.3	7	V	–
Current	I_D	–	–	–	internal limited
Ground					
Current	I_{GND}	50	–	mA	–
Reset Output					
Voltage	V_R	-0.3	7	V	–
Current	I_R	–	–	–	internal limited
Sense Output					
Voltage	V_{SO}	-0.3	7	V	–
Current	I_{SO}	–	–	–	internal limited
5-V Output					
Output voltage	V_Q	-0.5	7	V	–
Output current	I_Q	-10	–	mA	–
Temperature					
Junction temperature	T_j	–	150	°C	–
Storage temperature	T_{Stg}	-50	150	°C	–

Table 3 Absolute Maximum Ratings (cont'd)

$T_j = -40$ to 150 °C

Parameter	Symbol	Limit Values		Unit	Notes
		Min.	Max.		
Operating Range					
Input voltage	V_I	–	45	V	–
Junction temperature	T_j	-40	150	°C	–
Thermal Data					
Junction-ambient	R_{thja}	–	200	K/W	PG-DSO-8-16
		–	70	K/W	PG-DSO-14-30
Junction-pin	R_{thjp}	–	30	K/W	PG-DSO-14-30 1)

1) measured to Pin 4

Table 4 Characteristics
 $V_I = 13.5 \text{ V}; T_j = -40 \text{ }^\circ\text{C} < T_j < 125 \text{ }^\circ\text{C}$

Parameter	Symbol	Limit Values			Unit	Measuring Condition
		Min.	Typ.	Max.		
Output voltage	V_Q	4.90	5.00	5.10	V	$1 \text{ mA} \leq I_Q \leq 100 \text{ mA}$ $6 \text{ V} \leq V_I \leq 16 \text{ V}$
Current limit	I_Q	150	200	500	mA	–
Current consumption; $I_q = I_I - I_Q$	I_q	–	150	300	μA	$I_Q \leq 1 \text{ mA}, T_j < 85 \text{ }^\circ\text{C}$
Current consumption; $I_q = I_I - I_Q$	I_q	–	250	700	μA	$I_Q = 10 \text{ mA}$
Current consumption; $I_q = I_I - I_Q$	I_q	–	2	8	mA	$I_Q = 50 \text{ mA}$
Drop voltage	V_{dr}	–	0.25	0.5	V	$I_Q = 100 \text{ mA}^1)$
Load regulation	ΔV_Q	–	10	30	mV	$I_Q = 5 \text{ mA to } 100 \text{ mA}$
Line regulation	ΔV_Q	–	10	40	mV	$V_I = 6 \text{ V to } 26 \text{ V}$ $I_Q = 1 \text{ mA}$

Reset Generator

Switching threshold	V_{RT}	4.50	4.65	4.80	V	–
Reset adjust switching voltage	$V_{RADJ,TH}$	1.26	1.35	1.44	V	$V_Q > 3.5 \text{ V}$
Reset low voltage	$V_{RO,SAT}$	–	0.1	0.4	V	$R_{\text{extern}} = 20 \text{ k}\Omega$
Upper delay switching threshold	V_{UD}	1.4	1.8	2.2	V	–
Lower delay switching threshold	V_{LD}	0.3	0.45	0.60	V	–
Reset delay low voltage	$V_{D,SAT}$	–	–	0.1	V	$V_Q < V_{RT}$
Charge current	I_D	3.0	6.5	9.5	μA	$V_D = 1 \text{ V}$
Delay time L → H	t_d	17	28	–	ms	$C_D = 100 \text{ nF}$
Delay time H → L	t_t	–	1	–	μs	$C_D = 100 \text{ nF}$

Table 4 Characteristics (cont'd)

$V_I = 13.5\text{ V}; T_j = -40\text{ °C} < T_j < 125\text{ °C}$

Parameter	Symbol	Limit Values			Unit	Measuring Condition
		Min.	Typ.	Max.		
Input Voltage Sense						
Sense threshold high	$V_{SI, high}$	1.24	1.31	1.38	V	–
Sense threshold low	$V_{SI, low}$	1.16	1.20	1.28	V	–
Sense output low voltage	$V_{SO, low}$	–	0.1	0.4	V	$V_{SI} < 1.20\text{ V};$ $V_Q > 3\text{ V};$ $R_{extern} = 20\text{ k}\Omega$
Sense input current	I_{SI}	-1	0.1	1	μA	–

1) Drop voltage = $V_I - V_Q$ (measured when the output voltage has dropped 100 mV from the nominal value obtained at 13.5 V input.)

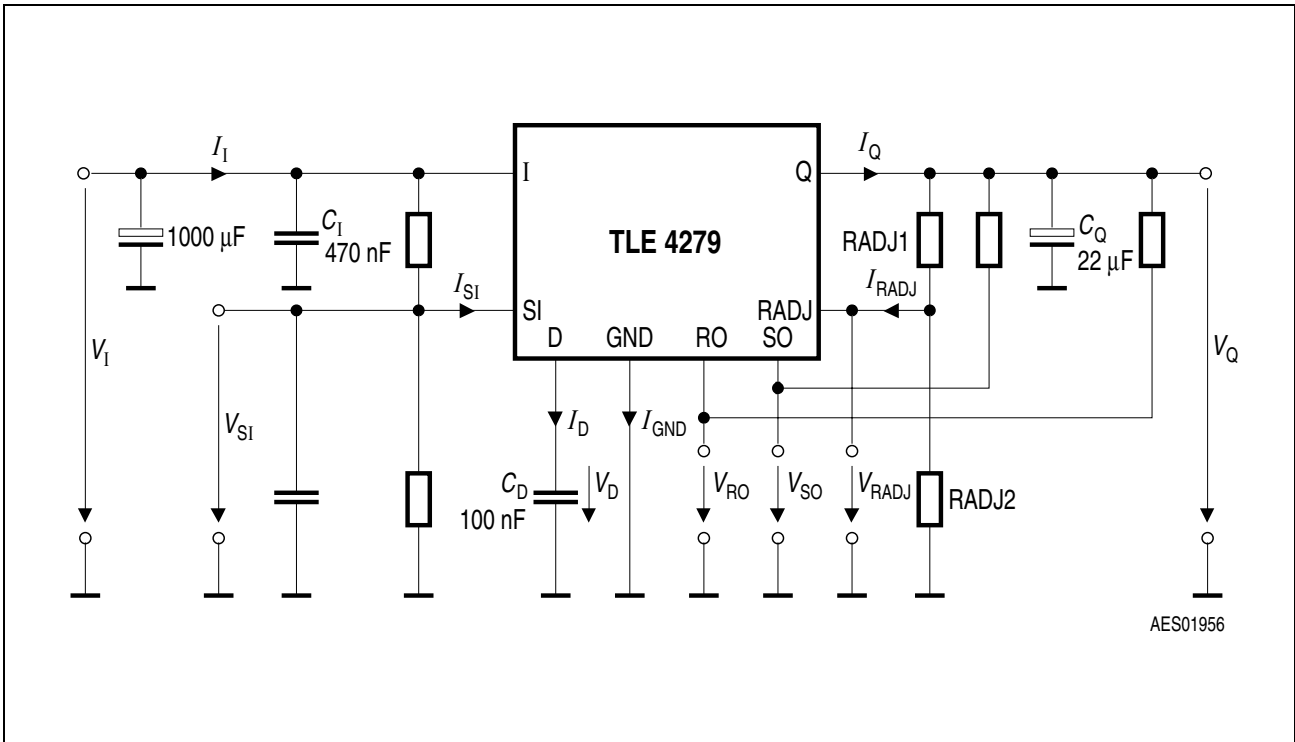

Figure 4 Measuring Circuit

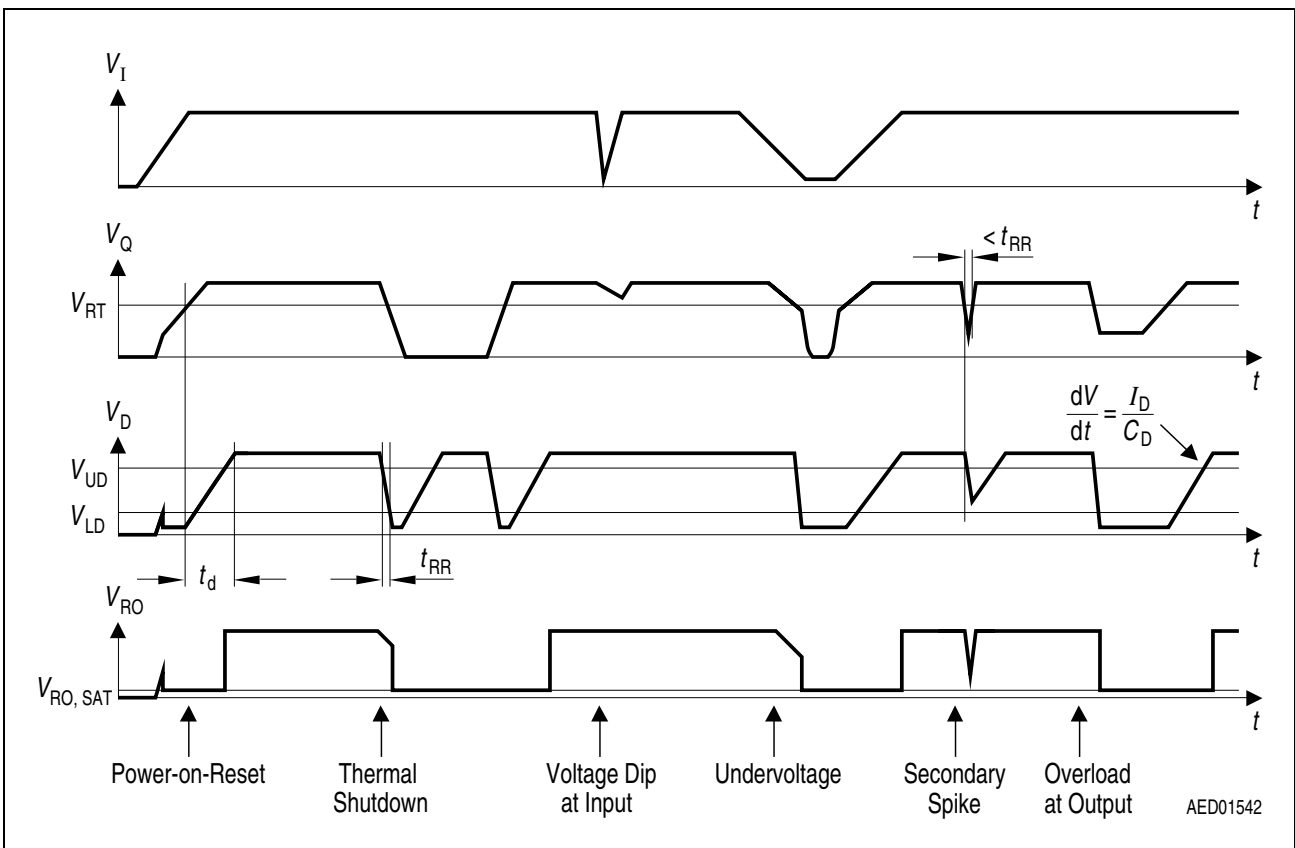

Figure 5 Reset Timing Diagram

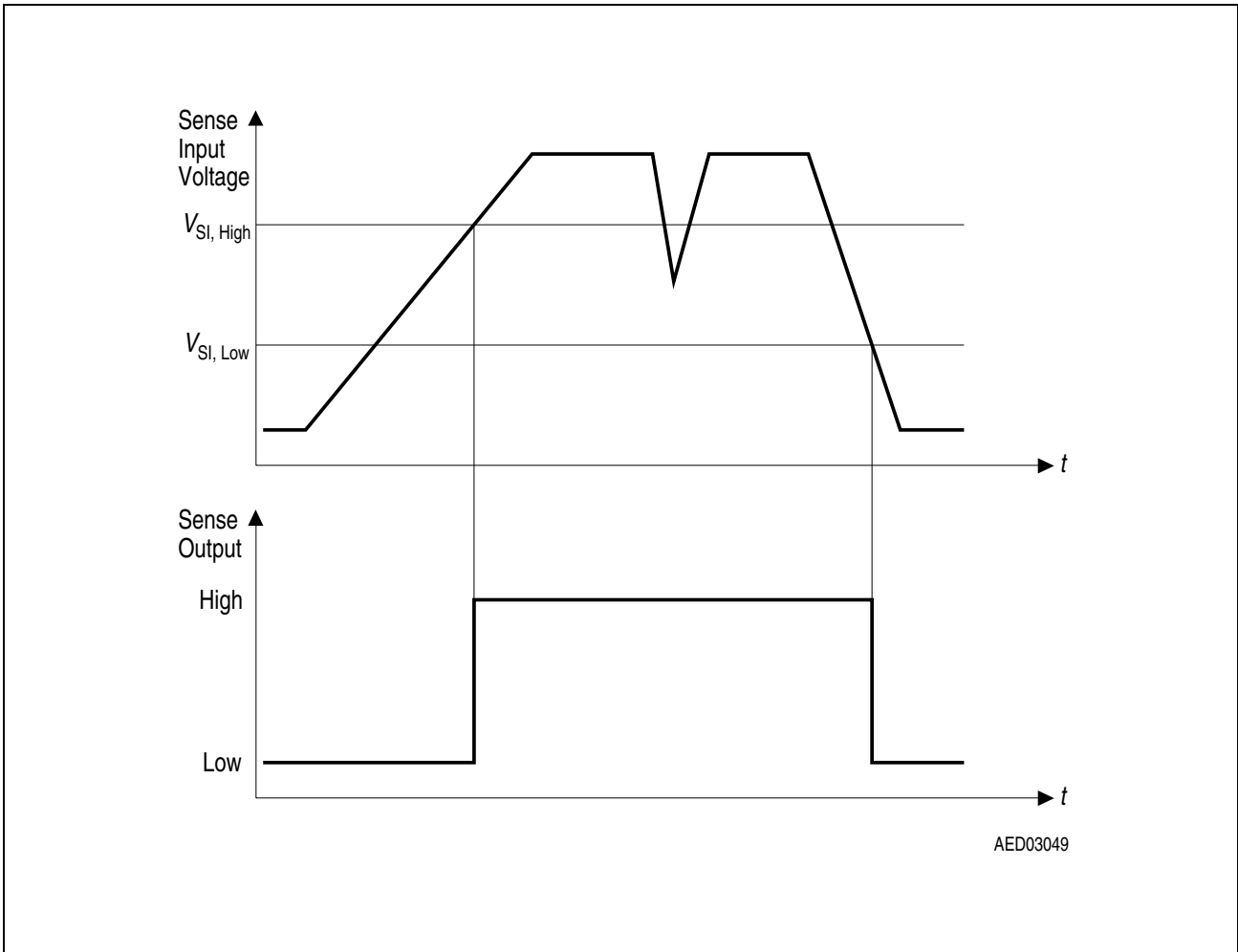
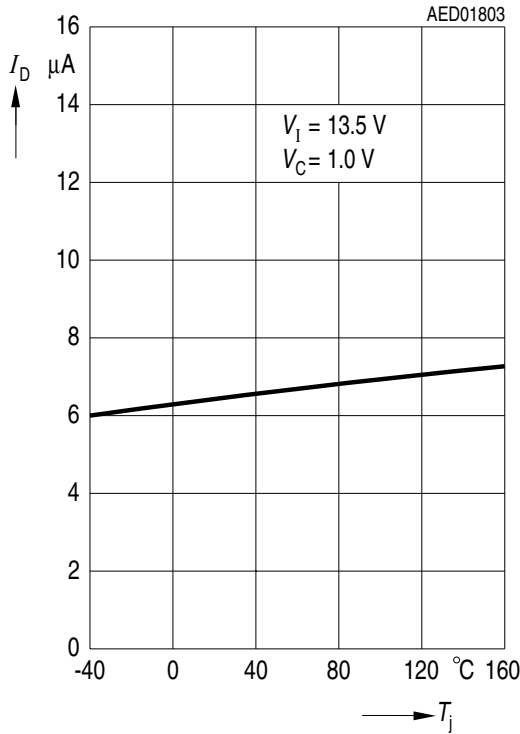
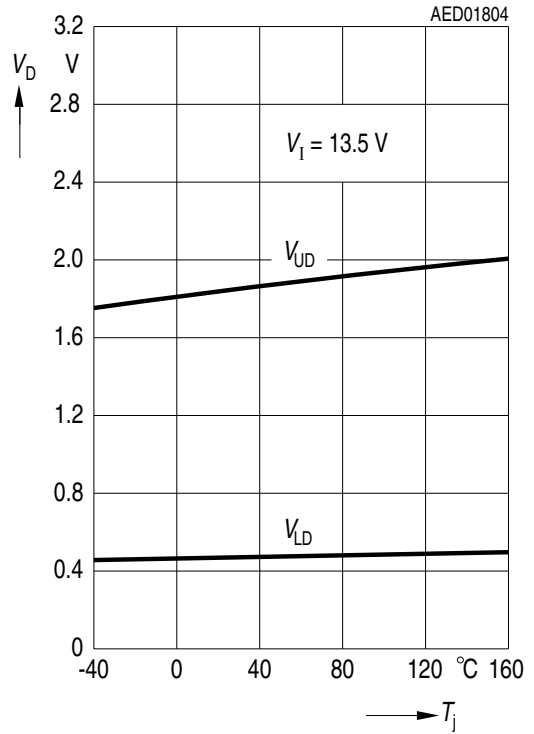

Figure 6 Sense Input Timing Diagram

Charge Current I_D versus Temperature T_j



Switching Voltage V_{UD} and V_{LD} versus Temperature T_j



Drop Voltage V_{dr} versus Output Current I_Q

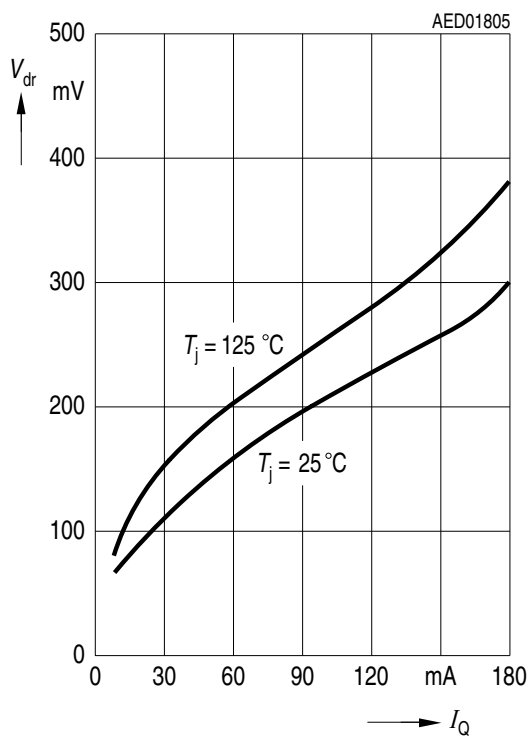

Reset Adjust Switching Threshold $V_{RADJ,TH}$ versus Temperature T_j

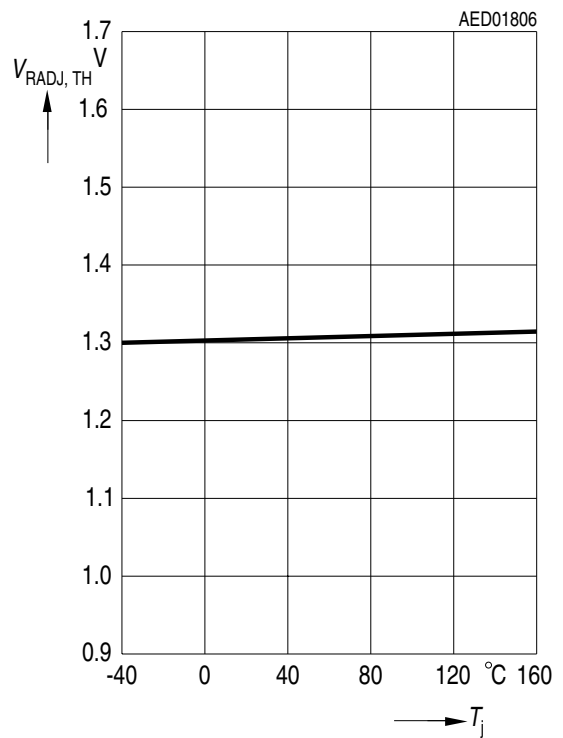

Current Consumption I_Q versus Input Voltage V_I

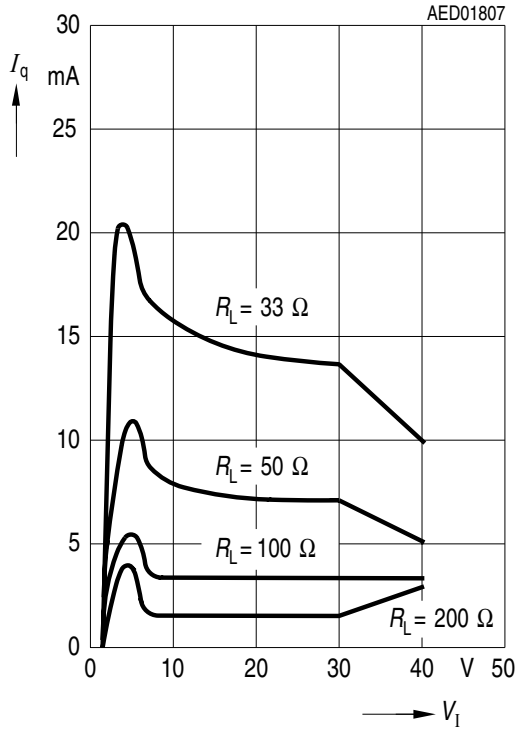

Output Voltage V_Q versus Input Voltage V_I

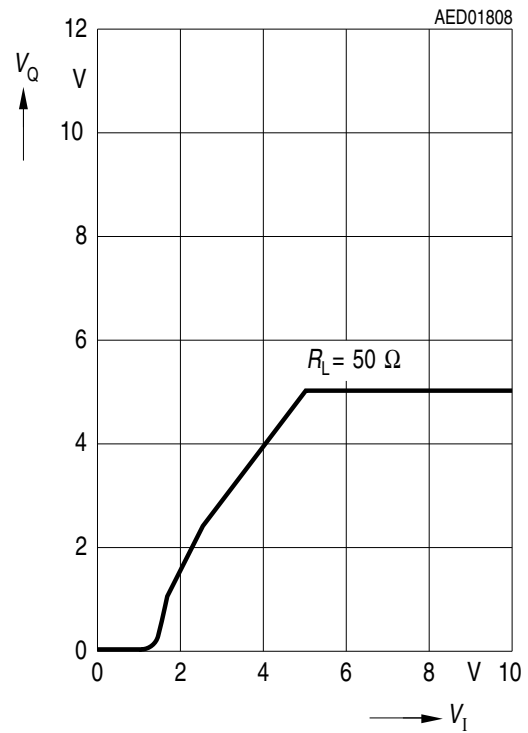

Sense Threshold V_{SI} versus Temperature T_j

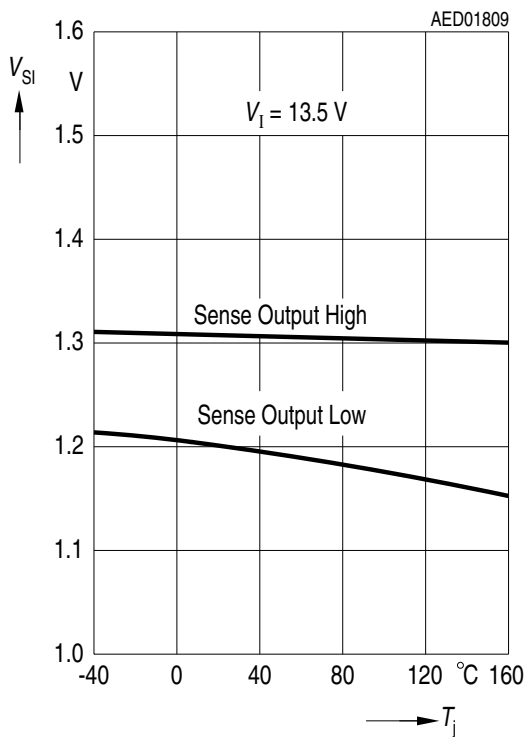

Output Voltage V_Q versus Temperature T_j

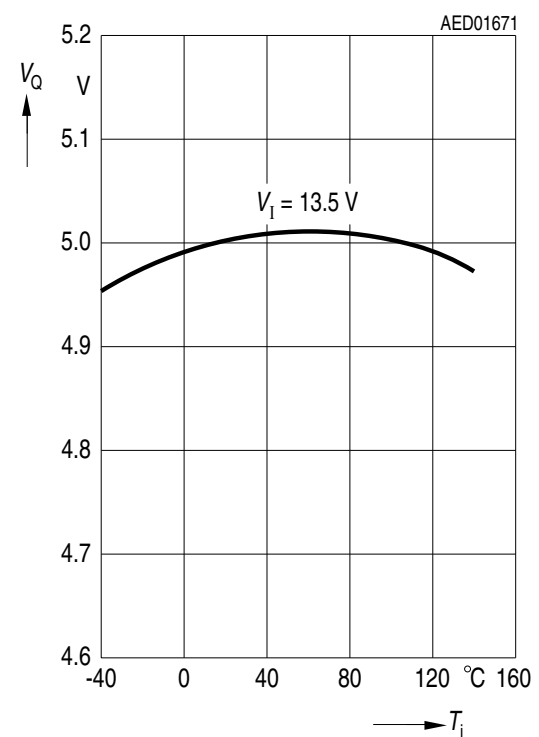

Output Current I_Q versus Input Voltage V_I

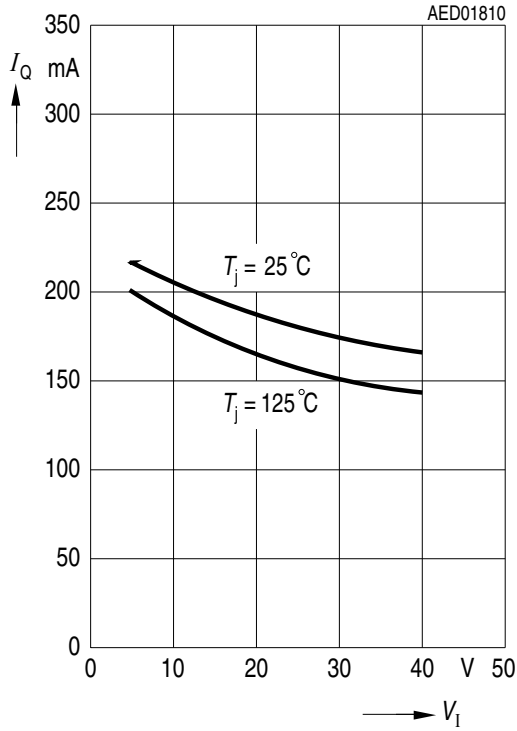

Current Consumption I_q versus Output Current I_Q

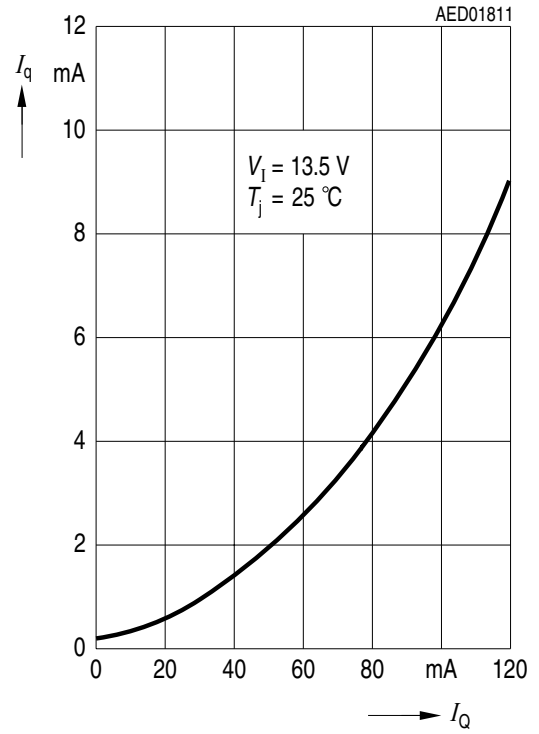

Current Consumption I_q versus Output Current I_Q

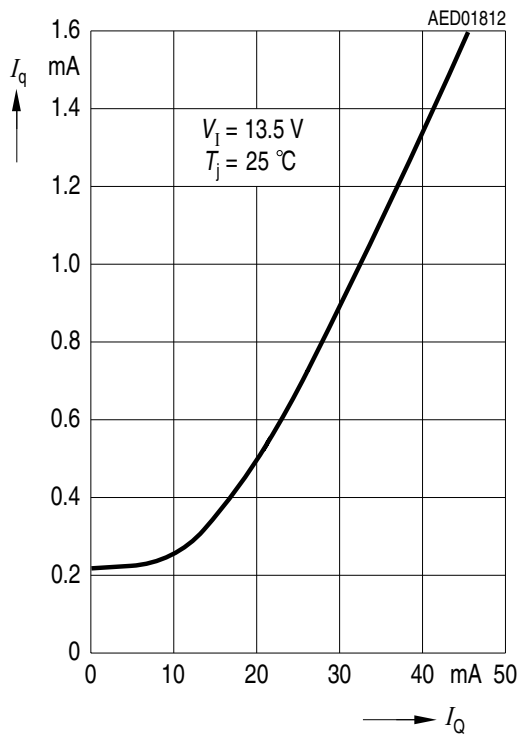

Package Outlines

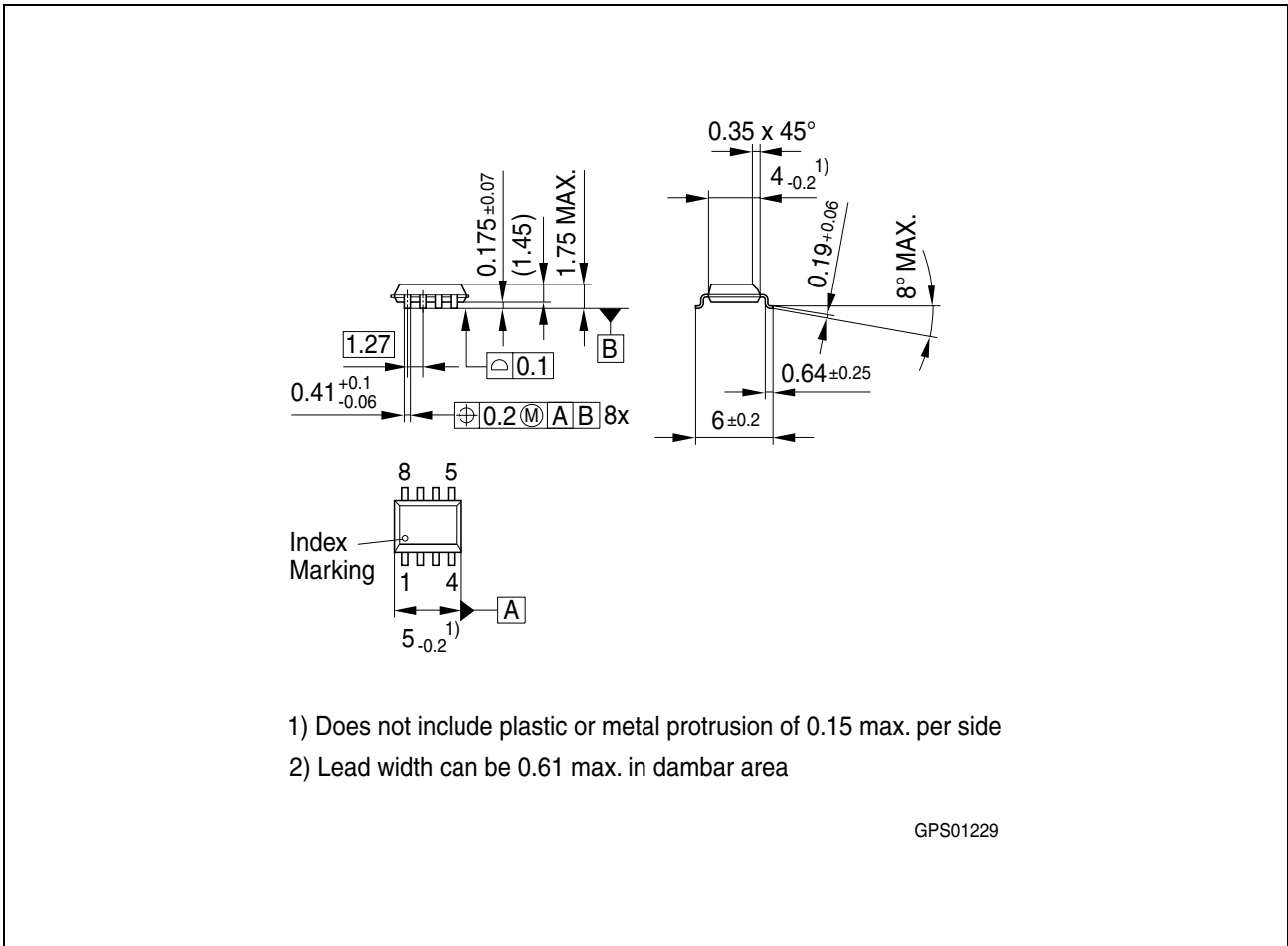

Figure 7 PG-DSO-8-16 (Plastic Dual Small Outline)

Green Product (RoHS compliant)

To meet the world-wide customer requirements for environmentally friendly products and to be compliant with government regulations the device is available as a green product. Green products are RoHS-Compliant (i.e Pb-free finish on leads and suitable for Pb-free soldering according to IPC/JEDEC J-STD-020).

You can find all of our packages, sorts of packing and others in our Infineon Internet Page "Products": <http://www.infineon.com/products>.

SMD = Surface Mounted Device

Dimensions in mm

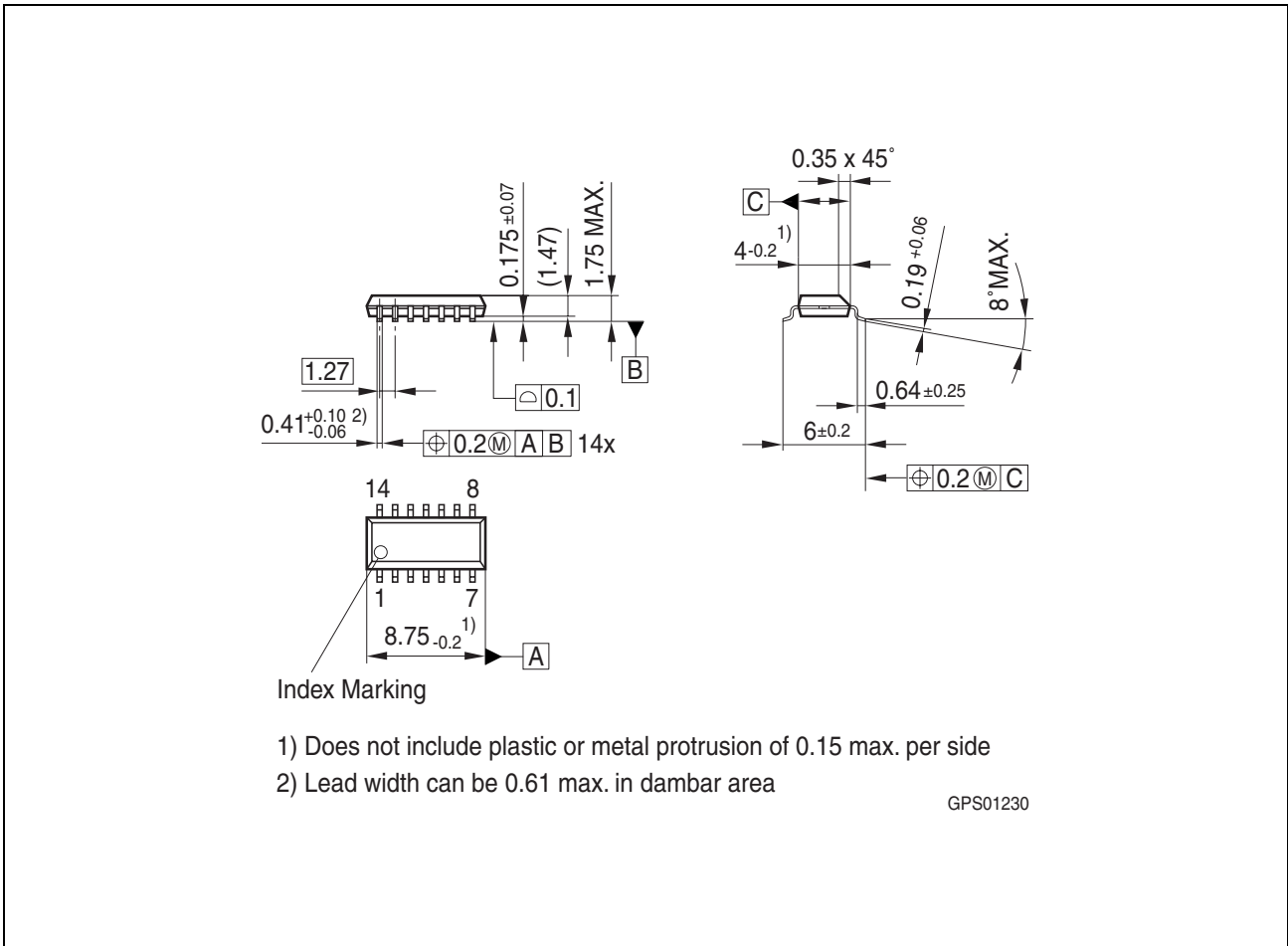

Figure 8 PG-DSO-14-30 (Plastic Dual Small Outline)

Green Product (RoHS compliant)

To meet the world-wide customer requirements for environmentally friendly products and to be compliant with government regulations the device is available as a green product. Green products are RoHS-Compliant (i.e Pb-free finish on leads and suitable for Pb-free soldering according to IPC/JEDEC J-STD-020).

You can find all of our packages, sorts of packing and others in our Infineon Internet Page “Products”: <http://www.infineon.com/products>.

SMD = Surface Mounted Device

Dimensions in mm

Revision History

Version	Date	Changes
Rev. 2.4	2007-03-20	Initial version of RoHS-compliant derivate of TLE 4279 Page 1 : AEC certified statement added Page 1 and Page 15f : RoHS compliance statement and Green product feature added Page 1 and Page 15f : Packages changed to RoHS compliant version Legal Disclaimer updated

Edition 2007-03-20

**Published by
Infineon Technologies AG
81726 Munich, Germany**

**© 2007 Infineon Technologies AG
All Rights Reserved.**

Legal Disclaimer

The information given in this document shall in no event be regarded as a guarantee of conditions or characteristics. With respect to any examples or hints given herein, any typical values stated herein and/or any information regarding the application of the device, Infineon Technologies hereby disclaims any and all warranties and liabilities of any kind, including without limitation, warranties of non-infringement of intellectual property rights of any third party.

Information

For further information on technology, delivery terms and conditions and prices, please contact the nearest Infineon Technologies Office (www.infineon.com).

Warnings

Due to technical requirements, components may contain dangerous substances. For information on the types in question, please contact the nearest Infineon Technologies Office.

Infineon Technologies components may be used in life-support devices or systems only with the express written approval of Infineon Technologies, if a failure of such components can reasonably be expected to cause the failure of that life-support device or system or to affect the safety or effectiveness of that device or system. Life support devices or systems are intended to be implanted in the human body or to support and/or maintain and sustain and/or protect human life. If they fail, it is reasonable to assume that the health of the user or other persons may be endangered.