

## GaAs PHEMT MMIC LOW NOISE AMPLIFIER, 2.3 - 2.7 GHz



### Typical Applications

The HMC667LP2(E) is ideal for:

- WiMAX, WiBro & Fixed Wireless
- SDARS & WLAN Receivers
- Infrastructure & Repeaters
- Access Points
- Telematics & DMB

### Features

- Low Noise Figure: 0.75 dB
- High Gain: 19 dB
- High Output IP3: +29.5 dBm
- Single Supply: +3V to +5V
- 6 Lead 2x2mm DFN Package: 4 mm<sup>2</sup>

### Functional Diagram

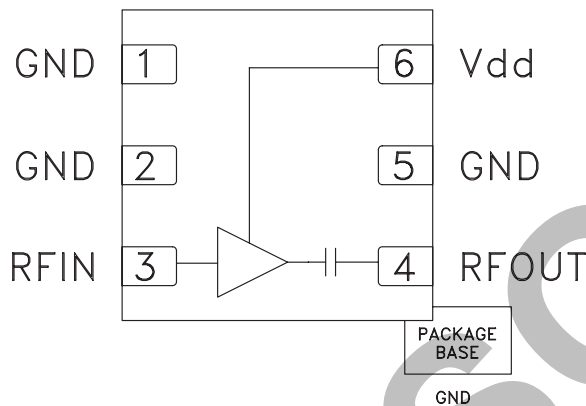

### General Description

The HMC667LP2(E) is a GaAs PHEMT MMIC Low Noise Amplifier that is ideal for WiMAX, WLAN and fixed wireless receivers operating between 2300 and 2700 MHz. This self-biased LNA has been optimized to provide 0.75 dB noise figure, 19 dB gain and +29.5 dBm output IP3 from a single supply of +5V. Input and output return losses are excellent and the LNA requires minimal external matching and bias decoupling components. The HMC667LP2(E) can also operate from a +3V supply for lower power applications.

### Electrical Specifications, $T_A = +25^\circ\text{C}$

Parameter	Vdd = +3 Vdc			Vdd = +5 Vdc			Units
	Min.	Typ.	Max.	Min.	Typ.	Max.	
Frequency Range	2300 - 2700			2300 - 2700			MHz
Gain	14	17.5		16	19		dB
Gain Variation Over Temperature		0.01			0.01		dB/ °C
Noise Figure		0.9	1.2		0.75	1.1	dB
Input Return Loss		10			12		dB
Output Return Loss		15			14		dB
Output Power for 1 dB Compression (P1dB)	9.5	11.5		13.5	16.5		dBm
Saturated Output Power (Psat)		12.5			17		dBm
Output Third Order Intercept (IP3)		22			29.5		dBm
Supply Current (Idd)		24	32		59	75	mA



**Broadband Gain & Return Loss**

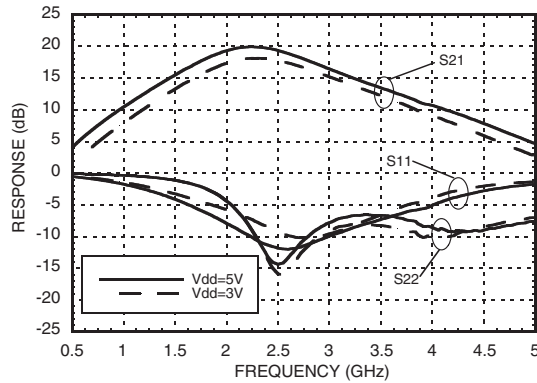

**Gain vs. Temperature**

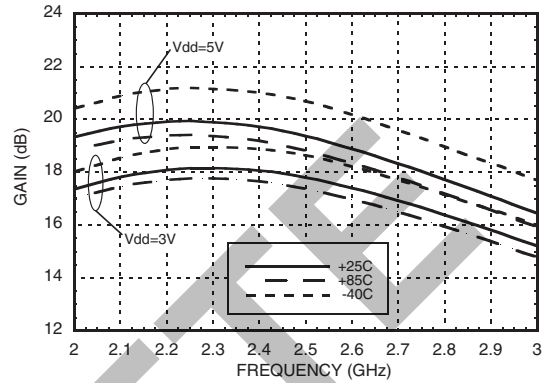

**Input Return Loss vs. Temperature [1]**

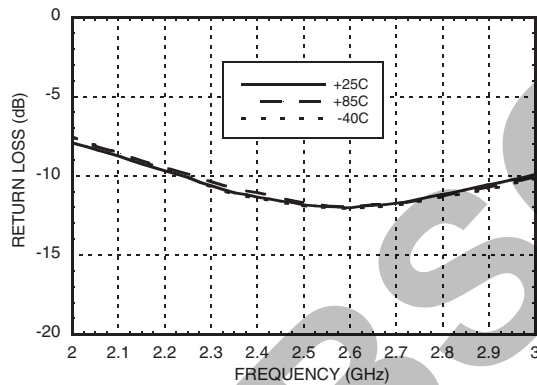

**Output Return Loss vs. Temperature [1]**

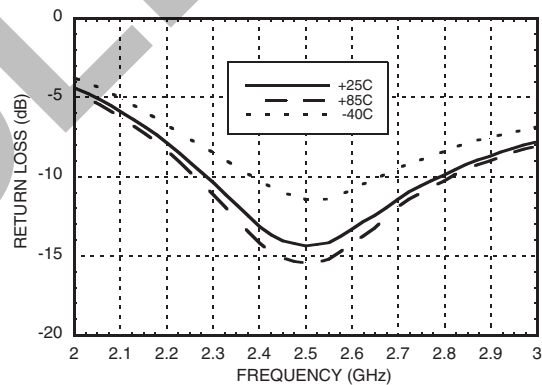

**Reverse Isolation vs. Temperature [1]**

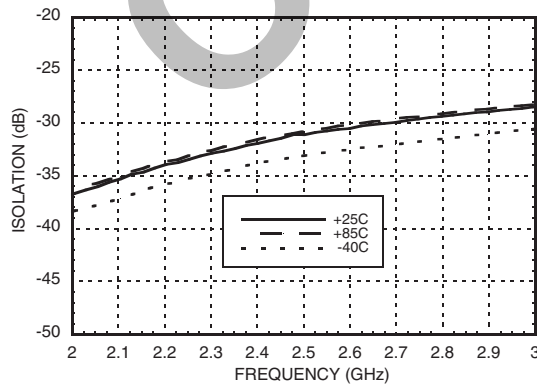

**P1dB vs. Temperature**

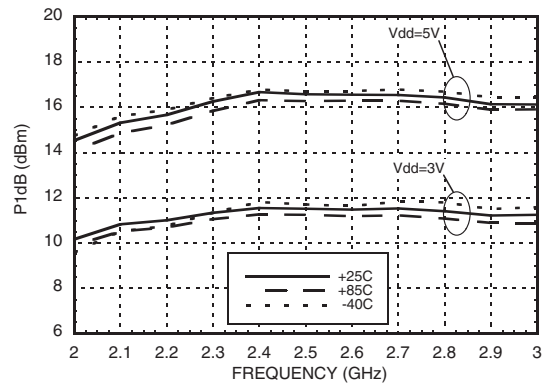

[1] Vdd = 5V

Information furnished by Analog Devices is believed to be accurate and reliable. However, no responsibility is assumed by Analog Devices for its use, nor for any infringements of patents or other rights of third parties that may result from its use. Specifications subject to change without notice. No license is granted by implication or otherwise under any patent or patent rights of Analog Devices. Trademarks and registered trademarks are the property of their respective owners.

For price, delivery, and to place orders: Analog Devices, Inc., One Technology Way, P.O. Box 9106, Norwood, MA 02062-9106 Phone: 781-329-4700 • Order online at [www.analog.com](http://www.analog.com) Application Support: Phone: 1-800-ANALOG-D



**Noise Figure vs. Temperature [1]**

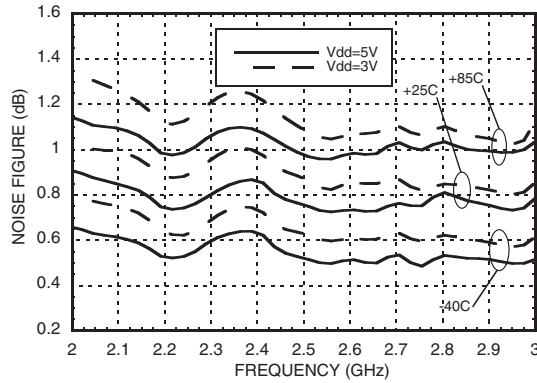

**Psat vs. Temperature**

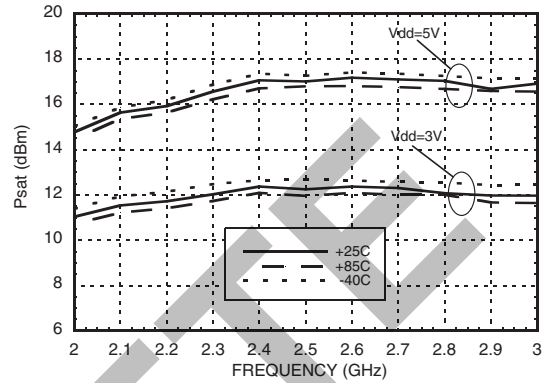

**Output IP3 vs. Temperature**

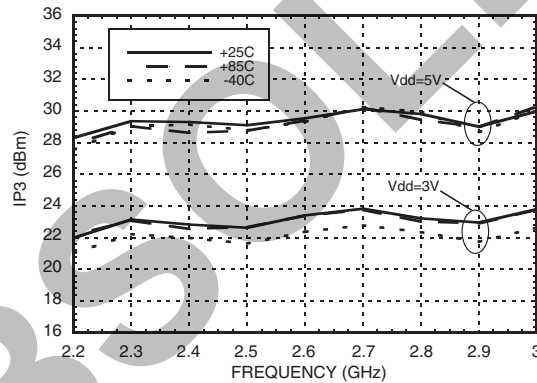

**Output IP3 and I<sub>dd</sub> vs. Supply Voltage @ 2300 MHz**

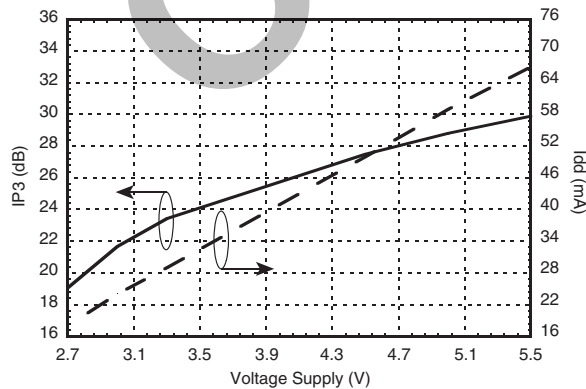

**Output IP3 and I<sub>dd</sub> vs. Supply Voltage @ 2500 MHz**

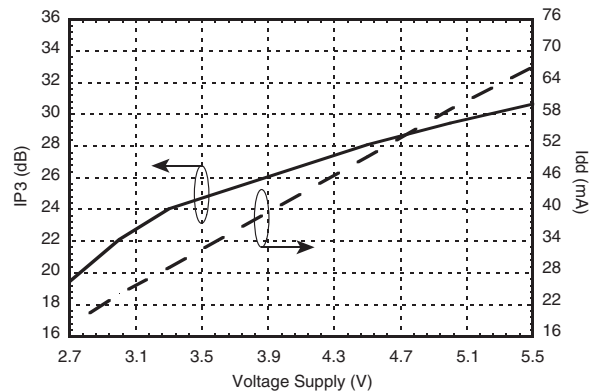

[1] Measurement reference plane shown on evaluation PCB drawing.



**Output Power, Gain & PAE @ 2300 MHz [1]**

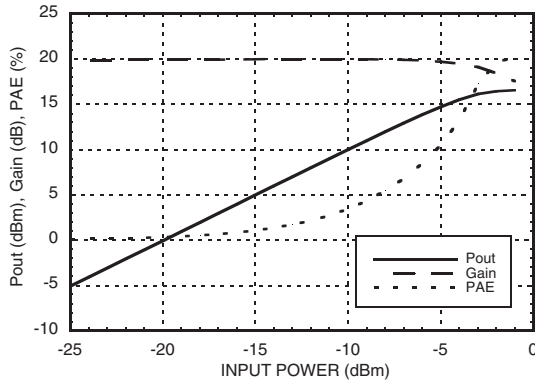

**Output Power, Gain & PAE @ 2300 MHz [2]**

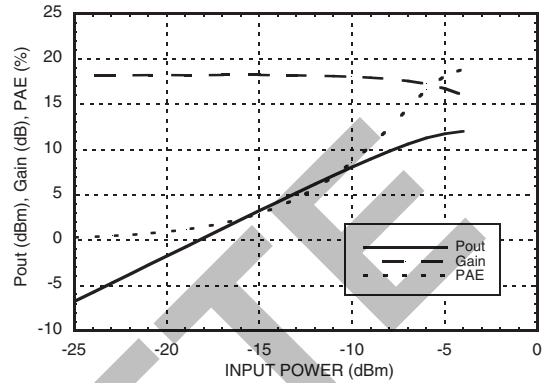

**Output Power, Gain & PAE @ 2500 MHz [1]**

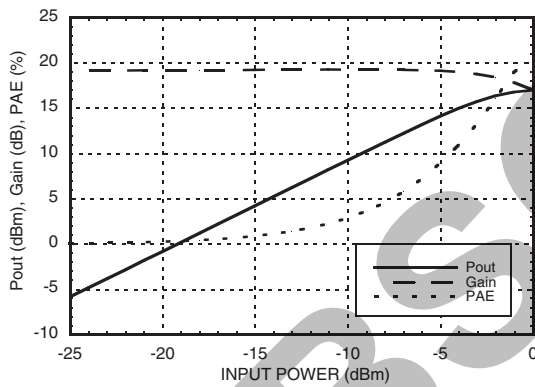

**Output Power, Gain & PAE @ 2500 MHz [2]**

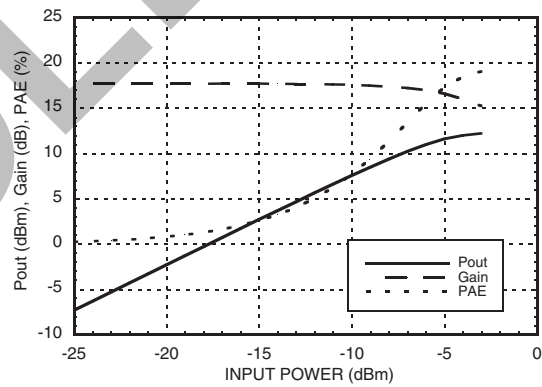

**P1dB, Gain, & Noise Figure vs. Supply Voltage @ 2300 MHz**

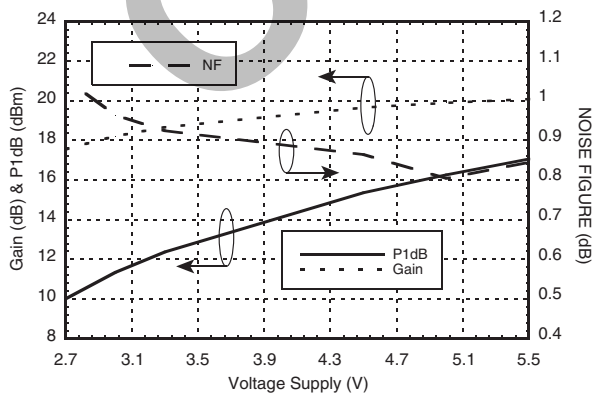

**P1dB, Gain, & Noise Figure vs. Supply Voltage @ 2500 MHz**

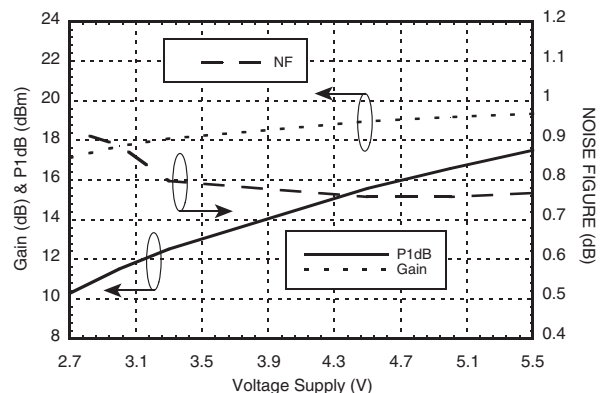

[1] Vdd = 5V [2] Vdd = 3V

Information furnished by Analog Devices is believed to be accurate and reliable. However, no responsibility is assumed by Analog Devices for its use, nor for any infringements of patents or other rights of third parties that may result from its use. Specifications subject to change without notice. No license is granted by implication or otherwise under any patent or patent rights of Analog Devices. Trademarks and registered trademarks are the property of their respective owners.

For price, delivery, and to place orders: Analog Devices, Inc., One Technology Way, P.O. Box 9106, Norwood, MA 02062-9106 Phone: 781-329-4700 • Order online at [www.analog.com](http://www.analog.com) Application Support: Phone: 1-800-ANALOG-D

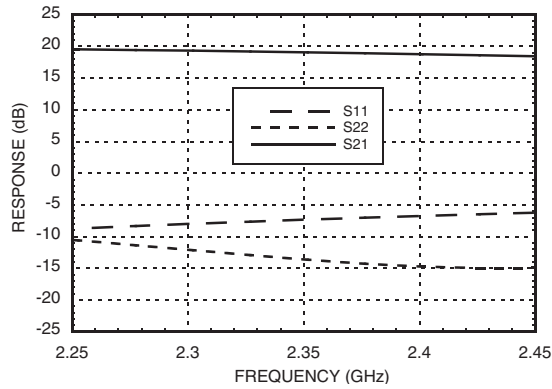
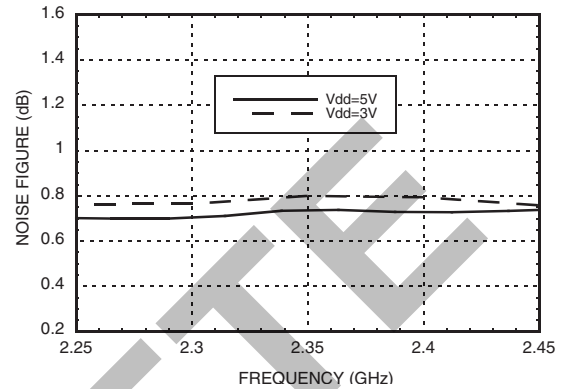
**Gain & Return Loss w/ SDARS Tune [1]**

**Noise Figure vs. Vdd w/ SDARS Tune [2]**

**Absolute Maximum Ratings**

Drain Bias Voltage (Vdd)	+6 Vdc
RF Input Power (RFIN)	+10 dBm
Channel Temperature	150 °C
Continuous Pdiss (T= 85 °C) (derate 5.88 mW/°C above 85 °C)	0.38 W
Thermal Resistance (Channel to Ground Paddle)	170 °C/W
Storage Temperature	-65 to +150 °C
Operating Temperature	-40 to +85 °C

**ELECTROSTATIC SENSITIVE DEVICE  
OBSERVE HANDLING PRECAUTIONS**

[1] Vdd = 5V [2] Measurement reference plane shown on evaluation PCB drawing.



**Outline Drawing**

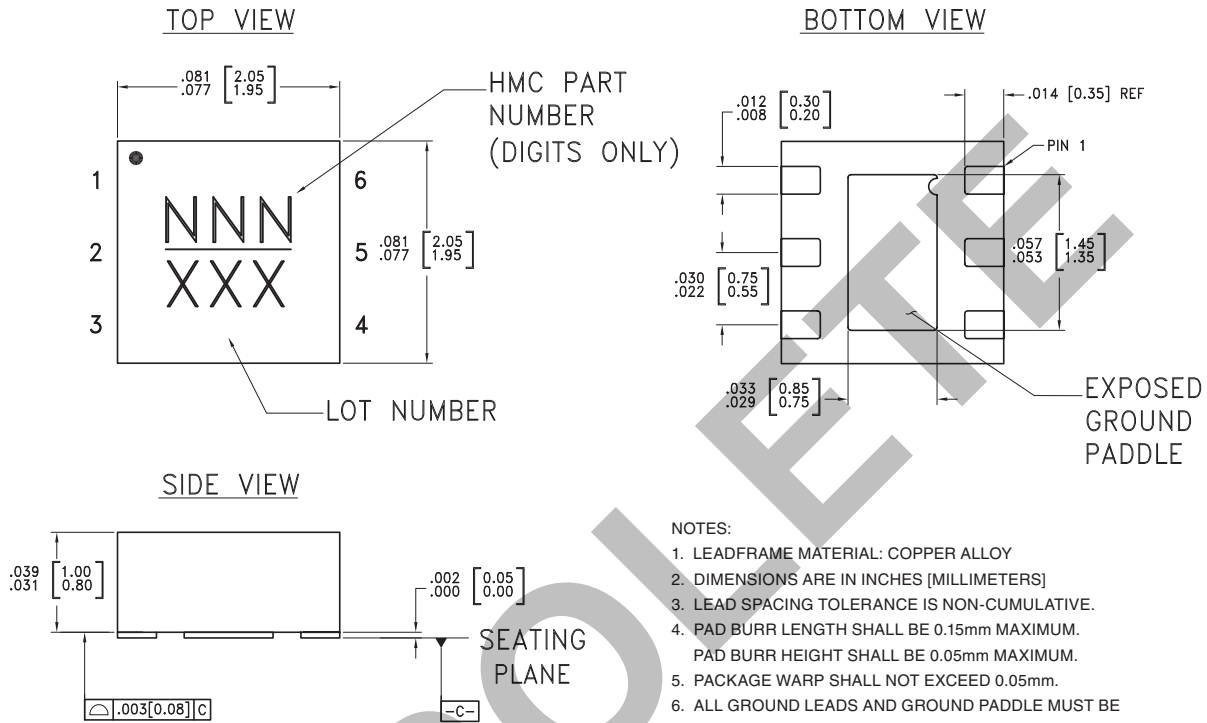

- NOTES:
1. LEADFRAME MATERIAL: COPPER ALLOY
  2. DIMENSIONS ARE IN INCHES [MILLIMETERS]
  3. LEAD SPACING TOLERANCE IS NON-CUMULATIVE.
  4. PAD BURR LENGTH SHALL BE 0.15mm MAXIMUM. PAD BURR HEIGHT SHALL BE 0.05mm MAXIMUM.
  5. PACKAGE WARP SHALL NOT EXCEED 0.05mm.
  6. ALL GROUND LEADS AND GROUND PADDLE MUST BE SOLDERED TO PCB RF GROUND.
  7. REFER TO HITTITE APPLICATION NOTE FOR SUGGESTED LAND PATTERN.

**Package Information**

Part Number	Package Body Material	Lead Finish	MSL Rating	Package Marking <sup>[3]</sup>
HMC667LP2	Low Stress Injection Molded Plastic	Sn/Pb Solder	MSL1 <sup>[1]</sup>	667 XXX
HMC667LP2E	RoHS-compliant Low Stress Injection Molded Plastic	100% matte Sn	MSL1 <sup>[2]</sup>	667 XXX

[1] Max peak reflow temperature of 235 °C  
 [2] Max peak reflow temperature of 260 °C  
 [3] 3-Digit lot number XXX



**Pin Descriptions**

Pin Number	Function	Description	Interface Schematic
1, 2, 5	GND	These pins and package bottom must be connected to RF/DC ground.	
3	RFIN	This pin is DC coupled See the application circuit for off-chip components	
4	RFOUT	This pin is AC coupled and matched to 50 Ohms.	
6	Vdd	Power supply voltage. Bypass capacitors are required. See application circuit.	

**Components for Selected Band**

Components	C1	L1	Evaluation PCB Number
Broadband	2.7 pF	2.0 nH	121891
SDARS	2.2 pF	4.3 nH	122404

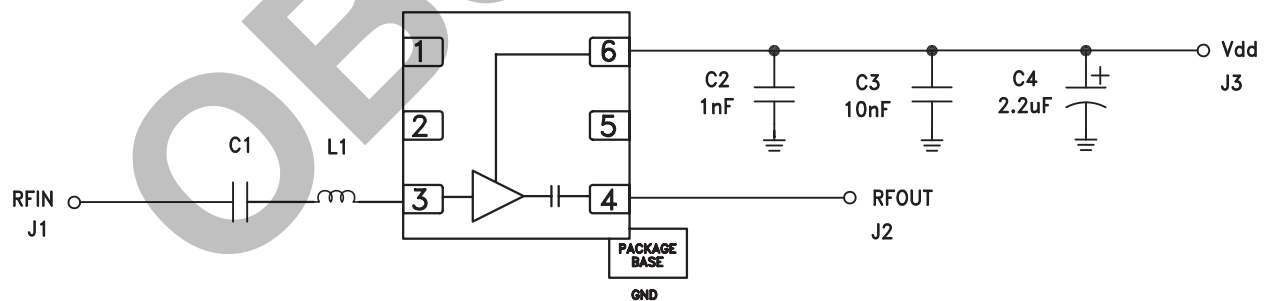

Information furnished by Analog Devices is believed to be accurate and reliable. However, no responsibility is assumed by Analog Devices for its use, nor for any infringements of patents or other rights of third parties that may result from its use. Specifications subject to change without notice. No license is granted by implication or otherwise under any patent or patent rights of Analog Devices. Trademarks and registered trademarks are the property of their respective owners.

For price, delivery, and to place orders: Analog Devices, Inc., One Technology Way, P.O. Box 9106, Norwood, MA 02062-9106 Phone: 781-329-4700 • Order online at [www.analog.com](http://www.analog.com) Application Support: Phone: 1-800-ANALOG-D



**Evaluation PCB**

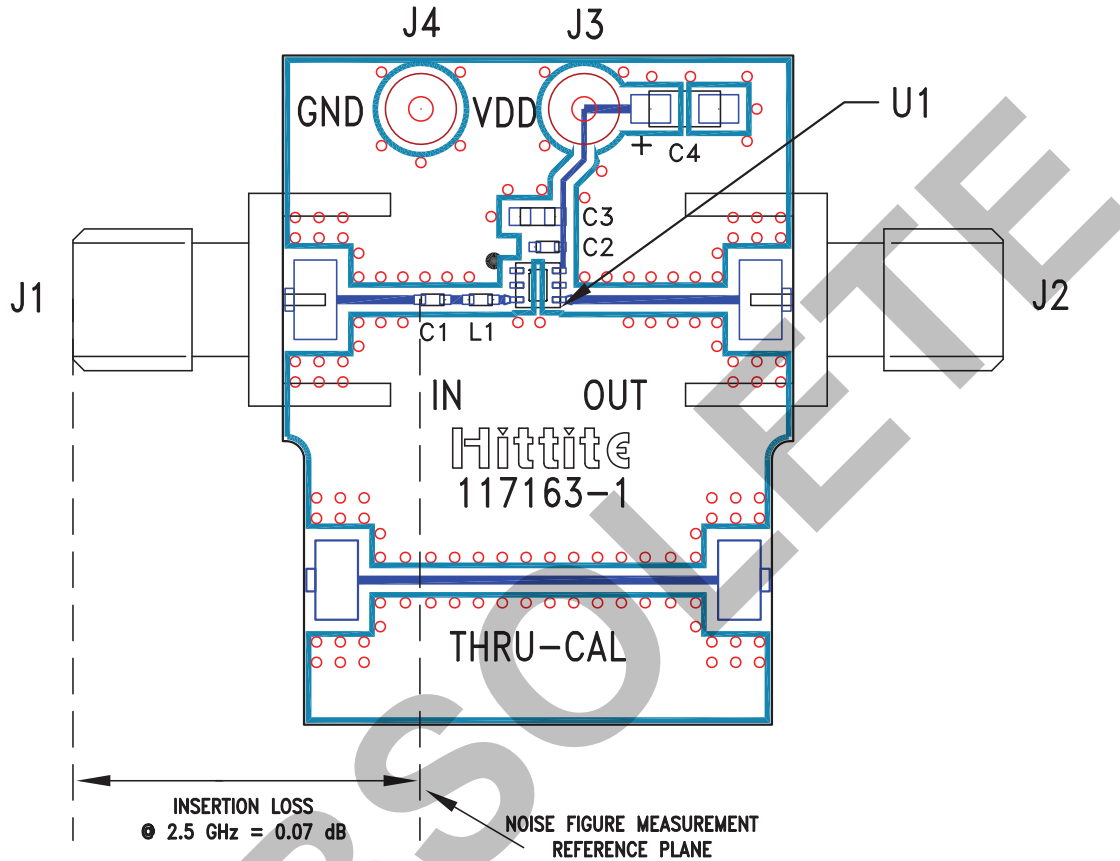

**List of Materials for Evaluation PCB [1]**

Item	Description
J1 - J2	PCB Mount SMA Connector
J3 - J4	DC Pin
C1	2.7 pF Capacitor, 0402 Pkg.
C2	1000 pF Capacitor, 0402 Pkg.
C3	10 nF Capacitor, 0603 Pkg.
C4	2.2 μF Capacitor, CASE-A Tantalum
L1	2 nH Inductor, 0402 Pkg.
U1	HMC667LP2(E) Amplifier
PCB [2]	117163 Evaluation PCB

[1] When requesting an evaluation board, please reference the appropriate evaluation PCB number listed in the table "Components for Selected Band" on previous page

[2] Circuit Board Material: Rogers 4350

The circuit board used in this application should use RF circuit design techniques. Signal lines should have 50 Ohm impedance while the package ground leads and exposed paddle should be connected directly to the ground plane similar to that shown. A sufficient number of via holes should be used to connect the top and bottom ground planes. The evaluation board should be mounted to an appropriate heat sink. The evaluation circuit board shown is available from Hittite upon request.