

MASTER[®] APPLIANCE

Designers and Manufacturers of Heat Tools for Industry

Master Heat Gun[®]

Varitemp[®]

Proheat[®]

Variair[®]

Masterflow[®]

Master-Mite[®]

Ecoheat[®]

Ultratorch[®]

Ultratip[®]

Ultratane[®]

Econolron[®]

PortaPro[®]

Multiseal[™]

Solderseal[™]

Proseal[™]



www.masterappliance.com

Master Appliance®

Table of Contents

■ Electric Heat Guns

Master and Varitemp® Series Heat Guns, Kits and Accessories

5 - 7

The original heavy-duty heat guns with rugged cast aluminum housing and powerful universal motor



Rotating Swivel Stand

Proheat® Series Heat Guns, Kits and Accessories

8 - 12

Compact, lightweight, easy-to-use with durable Lexan® plastic housing

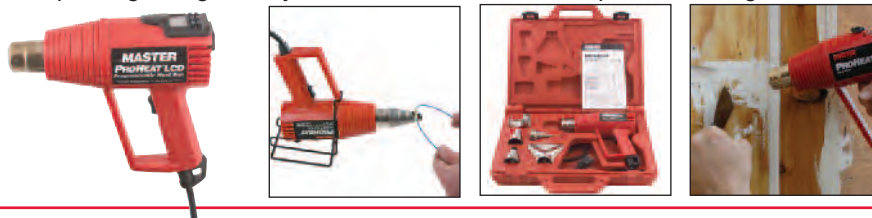

Ecoheat® Heat Gun, Kit and Accessories

13

Economical dual temperature heat gun with resettable thermostat for overheating protection



Masterflow® Continuous-Duty Heat Blowers

13

Continuous-duty heat blower with powerful 47 CFM air flow. Suitable for mounting over conveyors or on machinery



Master-Mite® and Master-Mite® ESD Continuous-Duty Bench-Top Heating Systems

14

Quiet motor with 3.8 CFM air flow provides a balance of heat and gentle air flow at the work station



■ Econolron® Butane-Powered Soldering Iron/Heat Tool and Kit

15

Economical soldering iron, flameless hot air tool and torch



■ Ultratorch® Butane-Powered Soldering Irons/Heat Tools and Kits featuring Ultratip® Technology

16 -23



■ Microtorch Butane-Powered Torches and Kits

Light-Duty Models MT-5, MT-11 • Heavy-Duty Models MT-30, MT-51, MT-70, MT-76, GT-70

24 - 27



■ Ultratane® Butane Fuel

28



RC-31
fuel cell



10448
1⁵/₁₆ OZ.



51773
5¹/₈ OZ.

■ PortaPro® Butane-Powered Hot Melt Glue Gun and Kit

29

Cordless flexibility, reaches operating temperature in less than 4 minutes, runs for over 2 hours

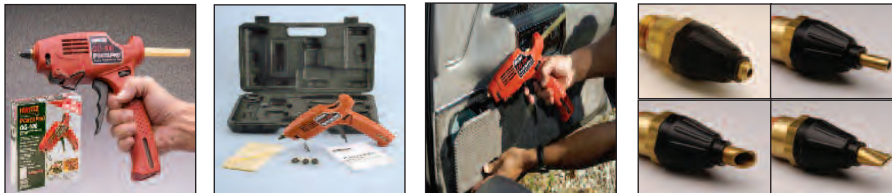

■ MicroPro® Light-Duty Soldering Irons

30

MP-100 Personal electric soldering iron with stand-by mode

BT-30 Battery-powered for easy transport to job site



■ Heat-Seal Electrical Connectors, Shrink Tubing and Crimpers

31 - 37





Master Appliance Corp., Designers and Manufacturers of Heat Tools for Industry

Located near the western shores of Lake Michigan in Racine, Wisconsin, Master Appliance invented and introduced the first industrial quality heat gun to the worldwide marketplace in 1958. In 1985, we introduced North America's first butane-powered, cordless soldering iron, torch and flameless heat tool, ideal for field use. These professional quality heat tools, and others developed since, have enjoyed worldwide market success. Today our products are used in thousands of facilities, workshops and in the field for drying, welding, shrinking, soldering, desoldering, gluing and for many other common and unique applications, where heat is the need.

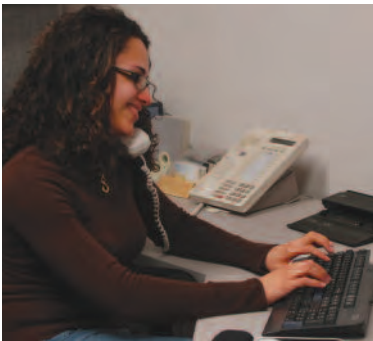

Master is continually developing innovative new heat tool products, with enhanced capabilities, making it easier to work with new materials and processes used throughout industry. With over 50 years of experience, the Master name stands for extraordinary expertise in heat technology, quality products and unsurpassed service. Whether you are considering a new application, material or process or simply looking to replace an old, tired heat tool, call us for fast professional service.

Local Availability, Sales, Parts & Service

Master heat tools are sold worldwide through a network of Authorized Stocking Distributors. Trained Sales and Customer Service Representatives, located at our headquarters and throughout the world, insure fast personal service. Contact us for your nearest stocking distributor or sales representative. **Visit our website for up-to-date information on products, accessories, parts, warranty and repair service.**



Master Appliance Corp.

2420 -18th Street, Racine, WI 53403-2300 U.S.A.

Sales/Customer Service: 800-558-9413

Local and International: 262-633-7791

Fax: 262-633-9745

E-mail: sales@masterappliance.com

Website: www.masterappliance.com

Engineering, Design, Research and Development

Master's goal is to provide the most advanced and rugged heat tools in the market, and the best product for your specific application. Our Heat Technology Specialists, using state-of-the-art systems, tools and test & measurement equipment, are constantly striving for better heat tool designs that are ergonomic, compact and lightweight or feature heavy-duty, stable bases for mounting or bench-top use.



Manufacturing

Master Heat® Tool products are made with superior, quality materials and the finest craftsmanship. Great designs and expert assembly, in a lean, efficient manufacturing setting, assure our customers maximum product quality, performance and value.

Master Varitemp® VTS Heat Gun

Deluxe Varitemp Heat Gun with versatile pivoting stand

- Stable, deluxe heavy-duty, pivoting metal stand with non-slip rubber feet
- Unique, adjustable spring loaded slide handle with ergonomic grip
- Easy selection of multiple pivoting angles for hands-free or hands-on use, to provide the best balance and aim
- High temperature and power ratings: Ambient to 1000°F/540°C at 1740 watts
- Variable temperature control provides easy dial-in temperatures
- Powerful high speed universal motor
- High air flow rating: 23 CFM at 3000 FPM gets the job done fast
- Sturdy die cast aluminum housing
- Double protected heating element housing
- Easily replaceable, reinforced, mica-insulated ceramic heating element
- Externally accessible carbon brush holders for quick replacement
- Three position "OFF-COLD-HOT" rocker switch
- 6 foot, 3-wire grounded cordset made with flexible, oil and sunlight resistant rubber jacket
- UL & CUL Listed. Made in USA
- Use to shrink tubing and packaging, bend plastics, cure adhesives, dry and heat parts, strip paint, defrost frozen pipes, heat sensitive materials, solder/desolder and more



Pivoting stand and adjustable slide grip handle

MASTER VARITEMP® VTS HEAT GUN			
MODEL NO.	DESCRIPTION		
VTS-750	Amb.-1000°/540°C	23 CFM	120V
	60 Hz 14.5A	1740W	cULus
VTS-752	Amb.-750°/400°C	23 CFM	
	50 Hz 7A	1680W	
HAS-043K	Replacement heating element for VTS-750		
HAS-014K	Replacement heating element for VTS-752		
35257	Replacement brush, cap and spring kit (2 each)		

Optional Accessories

PART NO.	DESCRIPTION
A-160-HG	Shrink attachment for tubing up to 3/4" O.D.
A-170-HG	Shrink attachment for tubing 3/4" to 2" O.D.
35245	Three popular attachments
30202	Solder preform attachment
51309	3/8" pinpoint attachment
51542	Glass protector attachment
51543	2-1/4" spreader attachment
51544	7/8" reducer attachment

Photos of accessories shown on page 7

Specifications

- Air Volume: 23 CFM ■ Air Velocity: 3000 FPM ■ Motor: Universal
- Nozzle Opening: 1.2" I.D., 1.5" O.D. ■ Cordset: 6 ft., 3-wire grounded ■ Dimensions: 9" L x 6" W x 12" H .
- Tool Net Weight: 5 lbs. ■ Shipping Weight: 8 lbs.



Ergonomic handle with spring loaded slide grip

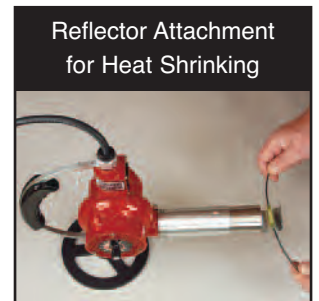

Deluxe stand gives more hands-free choices



Replacement Brush, Cap and Spring Kit (2 each)



Perfect for bench-top use in manufacturing and repair

NOTE: Users should independently evaluate the suitability of the product for their application.

Master & Varitemp® Heat Guns

Professional, heavy-duty, industrial quality, multiple use heat guns

- High temperature and power ratings: up to 1000°F/540°C at 1740 watts
- Varitemp model features variable temperature control which allows selection of temperatures from ambient to 1000°F/540°C
- High air flow rating: 23 CFM at 3000 FPM gets the job done fast
- Powerful high speed universal motor
- Sturdy die cast aluminum housing
- Double protected heating element housing
- Easily replaceable, reinforced, mica-insulated ceramic heating element
- Externally accessible carbon brush holders for quick replacement
- Three position "OFF-COLD-HOT" rocker switch
- Contoured, well balanced handle
- Non-slip rubber-backed base with 90° rotation
- 6 foot, 3-wire grounded cordset made with flexible, oil and sunlight resistant rubber jacket
- Optional Momentary Contact Switch
- UL & CUL Listed or CSA Certified. Made in USA
- Use to shrink tubing and packaging, bend plastics, cure adhesives, dry and heat parts, strip paint, defrost frozen pipes, heat sensitive materials, solder/desolder and more



c UL us
120V Models



USA
MADE IN

HG Series
Master Heat
Gun®

Momentary Contact Safety Switch:

if not held, unit will shut off

An option for Master Heat Gun® models. To order add "MC" suffix to model number. Example: HG-501A-MC.

Many international voltage/cordsets available upon request.

Contact our Sales Department for appropriate model numbers.

See our website for other parts and repair service information

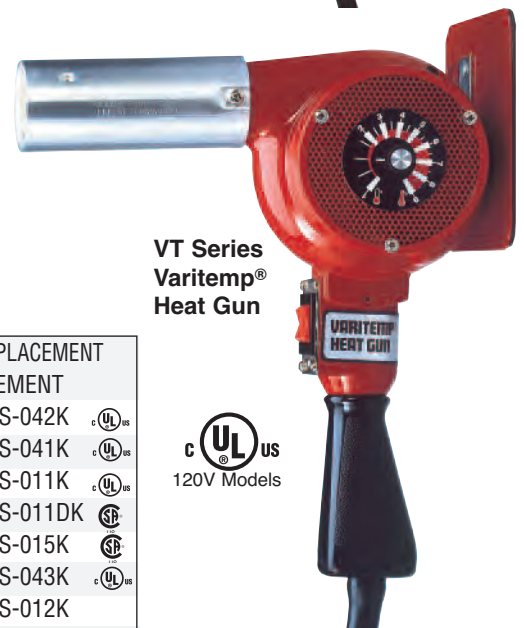

VT Series
Varitemp®
Heat Gun

c UL us
120V Models

MASTER HEAT GUN®								REPLACEMENT ELEMENT
MODEL NO.	DESCRIPTION							
HG-201A	200-300°F	93-150°C	23 CFM	120V	60 Hz	5A	600W	HAS-042K c UL us
HG-301A	300-500°F	150-260°C	23 CFM	120V	60 Hz	12A	1440W	HAS-041K c UL us
HG-501A	500-750°F	260-400°C	23 CFM	120V	60 Hz	14A	1680W	HAS-011K c UL us
HG-501A-D	500-750°F	260-400°C	23 CFM	120V	60 Hz	12A	1440W	HAS-011DK c UL us
HG-751A-C *	750-1000°F	400-540°C	23 CFM	120V	60 Hz	18A	2160W	HAS-015K c UL us
HG-751B	750-1000°F	400-540°C	23 CFM	120V	60 Hz	14.5A	1740W	HAS-043K c UL us
HG-202A	200-300°F	93-150°C	23 CFM	220V	50 Hz	3A	600W	HAS-012K
HG-302A	300-500°F	150-260°C	23 CFM	220V	50 Hz	6A	1440W	HAS-013K
HG-502A	500-750°F	260-400°C	23 CFM	220V	50 Hz	7A	1680W	HAS-014K
HG-752A	750-1000°F	400-540°C	23 CFM	220V	50 Hz	9A	1740W	HAS-016K
MASTER VARITEMP® HEAT GUN								REPLACEMENT ELEMENT
MODEL NO.	DESCRIPTION							
VT-750C	Amb. to 1000°F/540°C		23 CFM	120V	60 Hz	14.5A	1740W	HAS-043K c UL us
VT-752C	Amb. to 750°F/400°C		23 CFM	220V	50 Hz	7A	1680W	HAS-014K



Rotating Swivel Stand

Specifications

- Air Volume: 23 CFM
- Air Velocity: 3000 FPM
- Motor: Universal
- Nozzle Opening: 1.2" I.D., 1.5" O.D.
- Cordset: 6 ft., 3-wire grounded
- Dimensions: 9" L x 5.2" W x 10.1" H.
- Tool Net Weight: 3.7 lbs.
- Shipping Weight Tool: 5 lbs.
- Shipping Weight Kit: 10 lbs.



Replacement Heating Element



* NEMA 5-20P Plug

NOTE: Users should independently evaluate the suitability of the product for their application.

Master & Varitemp® Kits & Accessories

Add versatility to your HG & VT model heat guns

- Quality attachments are made of durable stainless steel
- Storage/carrying case protects heat gun and provides ample storage space for attachments
- Kits include a Master Heat Gun® or Varitemp® Heat Gun, A-160-HG shrink attachment, 51543 spreader attachment and 51544 reducer attachment packed in a rugged, plastic storage/carrying case



c UL US
120V Models

Master Heat Gun® Kit

USA
MADE IN

c UL US
120V Models



Varitemp® Heat Gun Kit

MASTER HEAT GUN® KIT								
MODEL NO	DESCRIPTION							
HG-201AK	200-300°F	93-150°C	23 CFM	120V	60 Hz	5A	600W	c UL US
HG-301AK	300-500°F	150-260°C	23 CFM	120V	60 Hz	12A	1440W	c UL US
HG-501AK	500-750°F	260-400°C	23 CFM	120V	60 Hz	14A	1680W	c UL US
HG-751BK	750-1000°F	400-540°C	23 CFM	120V	60 Hz	14.5A	1740W	c UL US
MASTER VARITEMP® HEAT GUN KIT								
MODEL NO.	DESCRIPTION							
VT-750CK	Amb.-1000°F	540°C	23 CFM	120V	60 Hz	14.5A	1740W	c UL US

Optional Accessories

PART NO.	DESCRIPTION
A-160-HG	Shrink attachment for tubing up to 3/4" O.D.
A-170-HG	Shrink attachment for tubing 3/4" to 2" O.D.
35245	Three popular attachments
30202 *	Solder preform attachment
51013	Molded storage carrying case
51309 *	3/8" pinpoint attachment
51542	Glass protector attachment
51543	2-1/4" spreader attachment
51544	7/8" reducer attachment

NOTE: Users should independently evaluate the suitability of the product for their application.



Thaw Pipes



Solder/Desolder



A-160-HG
Shrink attachment for tubing up to 3/4"



51543
2-1/4" Spreader attachment



51544
7/8" Reducer attachment



A-170-HG
Shrink attachment for tubing 3/4" to 2" O.D.



30202 *
Solder preform attachment



51309 *
3/8" Pinpoint attachment



51542
Glass protector attachment



35245
Three of our most popular attachments



51013
Rugged, plastic storage and carrying case for HG & VT Heat Guns only

* Not for use with HG-751B or HG-752A

Proheat® LCD Programmable Heat Gun & Kit

Rugged variable air flow, variable temperature heat gun with digital display

- Compact, lightweight, easy-to-use
- Six programmable settings with digital display of temperature and air flow
- Programmable heat and air flow removes the guess work
- Program temperature in 10° increments from 130° to 1000°F (50° - 540°C) in your choice of degrees Fahrenheit or Celsius
- Adjustable air flow from 4 - 16 CFM (113 - 453 l/min.)
- Electronic closed loop temperature control system maintains constant temperature when varying air flow or using specialty attachments
- Ergonomic handle provides balanced grip
- Temperature & Air Flow Lock-In feature provides added management control. Perfect for production applications requiring consistent application of heat
- Power-interrupt Reset safety feature prevents an unattended heat gun from resuming heat after a power failure
- Assembled in USA
- UL & CUL Listed or CE Certified
- Use to heat or dry temperature sensitive materials, shrink tubing, shrink packaging and specialty connectors, solder and desolder, bend plastics, activate adhesives, remove decals, defrost frozen pipes and more
- Multiple electrical plugs, attachments & bench stand available - see page 12

PH-1500
PH-2500



Programmable temperature and air flow controls with 6 memory functions



Quality attachments for professional applications

PH-1500K & PH-2500K

Proheat LCD Programmable Heat Gun with rugged storage case and all 5 specialty attachments

MODEL NO.	DESCRIPTION	Air Temperature	Air Velocity	Air Volume						
PH-1500	Heat Gun	130° - 1000°F/50° - 540°C	737 - 4000 FPM/213 - 1219m/min	4 - 16 CFM/113 - 453 l/min	120V	60 Hz	11A	1300W	cULus	
PH-1500K	Heat Gun Kit	PH-1500 Heat Gun with storage case and all 5 attachments (Part No. 35309) see page 12 for details								cULus
PH-2500	Heat Gun	130° - 1000°F/50° - 540°C	737 - 4000 FPM/213 - 1219m/min	4 - 16 CFM/113 - 453 l/min	230V	50/60 Hz	6.2A	1426W	CE	
PH-2500K	Heat Gun Kit	PH-2500 Heat Gun with storage case and all 5 attachments (Part No. 35309) see page 12 for details								CE

Specifications

- Motor: Permanent Magnet ■ Nozzle Opening: .88" I.D., 1.31" O.D.
- Cordset: 6 ft., 3-wire grounded ■ Dimensions: 8.2" L x 3.0" W x 7.3" H
- Tool Net Weight: 1.6 lbs. ■ Shipping Weight Tool: 3 lbs.
- Shipping Weight Kit: 7 lbs.

NOTE: Users should independently evaluate the suitability of the product for their application.

Use Preset Programs or Create Your Own

Preset Program	Temp °F	Temp °C	Air Flow CFM	Heat Gun Application
1	250	120	8	Applying specialty composites
2	450	230	12	Shrinking tubing
3	650	340	14	De-soldering circuit boards
4	850	450	16	Bending & forming plastics
5	1000	540	12	Soldering

Proheat® LCD Dial-in Heat Gun & Kit

Rugged variable air flow, variable temperature heat gun with digital display

- Compact, lightweight, easy-to-use
- LCD with digital display of temperature and air flow settings
- Dial-in temperatures in 10° increments from 130° - 1000°F (50° - 540°C) displayed in degrees Fahrenheit or Celsius
- Adjustable air flow from 4 to 16 CFM (113 - 453 l/min.)
- Electronic closed-loop temperature control system maintains constant temperature when varying air flow or using specialty attachments
- Balanced ergonomic design and grip prevents operator fatigue
- Temperature & Air Flow Lock-In feature provides added management control. Perfect for production applications requiring consistent application of heat
- Power-interrupt Reset safety feature prevents an unattended heat gun from resuming heat after a power failure
- Assembled in USA
- UL & CUL Listed or CE Certified
- Use to heat or dry temperature sensitive materials, shrink tubing, shrink packaging and specialty connectors, solder and desolder, bend plastics, activate adhesives, remove decals, defrost frozen pipes and more
- Multiple electrical plugs, attachments & bench stand available - see page 12

PH-1400
PH-2400



Dial-in variable temperature & air flow controls



Quality attachments for professional applications

PH-1400K & PH-2400K
Proheat LCD Dial-in Heat Gun with rugged storage case and all 5 specialty attachments

MODEL NO.	DESCRIPTION	Air Temperature	Air Velocity	Air Volume						
PH-1400	Heat Gun	130° - 1000°F/50° - 540°C	737 - 4000 FPM/213-1219m/min	4 - 16 CFM/113 - 453 l/min	120V	60 Hz	11A	1300W	cUL _{us}	
PH-1400K	Heat Gun Kit	PH-1400 Heat Gun with storage case and all 5 attachments (Part No. 35309) see page 12 for details								cUL _{us}
PH-1400-1	Heat Shrink System	PH-1400 Heat Gun with bench stand (35216) and specialty connector attachment (35292)								cUL _{us}
PH-2400	Heat Gun	130° - 1000°F/50° - 540°C	737 - 4000 FPM/213 - 1219m/min	4 - 16 CFM/113 - 453 l/min	230V	50/60 Hz	6.2A	1426W	CE	
PH-2400K	Heat Gun Kit	PH-2400 Heat Gun with storage case and all 5 attachments (Part No. 35309) see page 12 for details								CE
PH-2400-1	Heat Shrink System	PH-2400 Heat Gun with bench stand (35216) and specialty connector attachment (35292)								CE

Bench-Top Heat Shrink System with Locking Controls

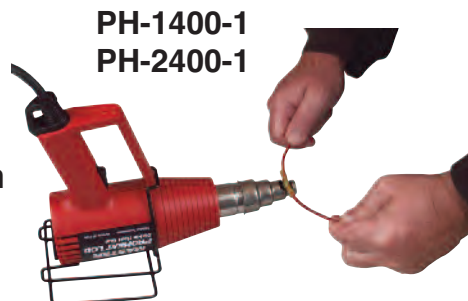

Specifications

- Motor: Permanent Magnet
- Nozzle Opening: .88" I.D., 1.31" O.D.
- Cordset: 6 ft., 3-wire grounded
- Dimensions: 8.2" L x 3.0" W x 7.3" H
- Tool Net Weight: 1.6 lbs.
- Shipping Weight Tool: 3 lbs.
- Shipping Weight Kit: 7 lbs.

NOTE: Users should independently evaluate the suitability of the product for their application.

Proheat® Variair® Heat Gun & Kit

Rugged variable air flow, variable temperature heat gun

- Compact, lightweight, easy-to-use
- Balanced ergonomic design prevents operator fatigue
- Variable temperature from 130° - 1000°F (54° - 540°C)
- Variable air flow from 4 - 16 CFM
- Electronic closed loop temperature control system maintains constant temperature when varying air flow or using specialty attachments
- Protective hand/switch guard and hanging loop
- Power-interrupt Reset safety feature prevents an unattended heat gun from resuming heat after a power failure
- Assembled in USA
- New 230 Volt models PH-2300, PH-2300-1 & PH-2300K
- UL & CUL Listed or CE Certified
- Use to heat temperature sensitive materials including specialty connectors, solder preforms, shrink tubing and more
- Multiple electrical plugs, attachments & bench stand available - see page 12

PH-1300
PH-2300



NEW!
European Models



Dial-in variable temperature and air flow controls



Quality attachments for professional applications



PH-1300K & PH-2300K

Proheat Variair Heat Gun with rugged storage case and all 5 specialty attachments

MODEL NO.	DESCRIPTION	Air Temperature	Air Velocity	Air Volume						
PH-1300	Heat Gun	130° - 1000°F/50° - 540°C	737 - 4000 FPM/213 - 1219m/min	4 - 16 CFM/113 - 453 l/min	120V	60 Hz	11A	1300W	cUL US	
PH-1300K	Heat Gun Kit	PH-1300 Heat Gun with storage case and all 5 attachments (Part No. 35309) see page 12 for details								cUL US
PH-1300-1	Heat Shrink System	PH-1300 Heat Gun with bench stand (35216) and specialty connector attachment (35292)								cUL US
PH-2300	Heat Gun	130° - 1000°F/50° - 540°C	737 - 4000 FPM/213 - 1219m/min	4 - 16 CFM/113 - 453 l/min	230V	50/60 Hz	6.2A	1426W	CE	
PH-2300K	Heat Gun Kit	PH-2300 Heat Gun with storage case and all 5 attachments (Part No. 35309) see page 12 for details								CE
PH-2300-1	Heat Shrink System	PH-2300 Heat Gun with bench stand (35216) and specialty connector attachment (35292)								CE

Specifications

- Motor: Permanent Magnet ■ Nozzle Opening: .88" I.D., 1.31" O.D.
- Cordset: 6 ft., 3-wire grounded ■ Dimensions: 8.2" L x 3.0" W x 7.3" H
- Tool Net Weight: 1.6 lbs. ■ Shipping Weight Tool: 3 lbs.
- Shipping Weight Kit: 7 lbs.

NOTE: Users should independently evaluate the suitability of the product for their application.

Bench-Top Heat Shrink System



PH-1300-1
PH-2300-1

Proheat® Varitemp® Heat Gun & Kit

Rugged variable temperature heat gun

- Compact, lightweight, easy-to-use
- Balanced ergonomic design prevents operator fatigue
- Variable temperature from 130° - 1000°F (50° - 540°C)
- Electronic closed loop temperature control system maintains constant temperature and protects unit from overheating
- Protective hand/switch guard and hanging loop
- Assembled in USA
- UL & CUL Listed or CE Certified
- Use to heat temperature sensitive materials including specialty connectors, solder preforms, shrink tubing
- Multiple electrical plugs, attachments & bench stand available - see page 12

PH-1200
PH-2200



Easy access variable temperature control



Quality attachments for professional applications

PH-1200K & PH-2200K

Proheat Varitemp Heat Gun with rugged storage case and all 5 specialty attachments

MODEL NO.	DESCRIPTION	Air Temperature	Air Velocity	Air Volume						
PH-1200	Heat Gun	130° - 1000°F/50° - 540°C	4000 FPM/1219m/min	16 CFM/453 l/min	120V	60 Hz	11A	1300W	cUL _{US}	
PH-1200K	Heat Gun Kit	PH-1200 Heat Gun with storage case and all 5 attachments (Part No. 35309) see page 12 for details								cUL _{US}
PH-1200-1	Heat Shrink System	PH-1200 Heat Gun with bench stand (35216) and specialty connector attachment (35292)								cUL _{US}
PH-2200	Heat Gun	130° - 1000°F/50° - 540°C	4000 FPM/1219m/min	16 CFM/487 l/min	230V	50/60 Hz	6.2A	1426W	CE	
PH-2200K	Heat Gun Kit	PH-2200 Heat Gun with storage case and all 5 attachments (Part No. 35309) see page 12 for details								CE
PH-2200-1	Heat Shrink System	PH-2200 Heat Gun with bench stand (35216) and specialty connector attachment (35292)								CE

Specifications

- Motor: Permanent Magnet ■ Nozzle Opening: .88" I.D., 1.31" O.D.
- Cordset: 6 ft., 3-wire grounded ■ Dimensions: 8.2" L x 3.0" W x 7.3" H
- Tool Net Weight: 1.6 lbs. ■ Shipping Weight Tool: 3 lbs.
- Shipping Weight Kit: 7 lbs.

NOTE: Users should independently evaluate the suitability of the product for their application.

Bench-Top Heat Shrink System

PH-1200-1
PH-2200-1



Proheat® Heat Gun, Kit & Accessories

Rugged dual temperature heat gun & momentary contact heat gun

- Compact, lightweight, easy-to-use
- Balanced ergonomic design prevents operator fatigue
- Two heat settings 500°F or 1000°F (260°C or 540°C)
- Protective hand/switch guard and hanging loop
- New PH-1000 & PH-2000 models have Momentary Contact Switch
- UL & CUL Listed or CE Certified, Assembled in USA
- Use to activate adhesives, bend plastics, dry filler material, shrink tubing and more
- Multiple electrical plugs, 2 attachments & bench stand available - see below

PH-1000
PH-1100
PH-2000
PH-2100



PH-1100K
PH-2100K

Proheat Dual Temperature Heat Gun with rugged storage case and 2 attachments (35016 & 35017)

Specifications

- Motor: Permanent Magnet ■ Nozzle Opening: .88" I.D., 1.31" O.D.
- Cordset: 6 ft., 3-wire grounded ■ Dimensions: 8.2" L x 3.0" W x 7.3" H
- Tool Net Weight: 1.6 lbs. ■ Shipping Weight Tool: 3 lbs.
- Shipping Weight Kit: 7 lbs.

NOTE: Users should independently evaluate the suitability of the product for their application.

MODEL NO.	DESCRIPTION	Air Temperature	Air Velocity	Air Volume							
PH-1100	Heat Gun	500° or 1000°F/260° or 540°C	4000 FPM/1219m/min	16 CFM/453 l/min	120V	60 Hz	11A	1300W	UL	US	
PH-1100K	Heat Gun Kit	PH-1100 Heat Gun with storage case and 2 attachments (35016 & 35017)								UL	US
PH-1000	Heat Gun	1000°F/540°C	4000 FPM/1219m/min	16 CFM/453 l/min	120V	60 Hz	11A	1300W	UL	US	
		with Momentary Contact Safety Switch (if not held, unit will shut off)									
PH-2100	Heat Gun	500° or 1000°F/260° or 540°C	4000 FPM/1219m/min	16 CFM/453 l/min	230V	50/60 Hz	6.2A	1426W	CE		
PH-2100K	Heat Gun Kit	PH-2100 Heat Gun with storage case and 2 attachments (35016 & 35017)								CE	
PH-2000	Heat Gun	1000°F/540°C	4000 FPM/1219m/min	16 CFM/453 l/min	230V	50/60 Hz	6.2A	1426W	CE		
		with Momentary Contact Safety Switch (if not held, unit will shut off)									

Proheat® Heat Gun Accessories

Professional quality options and accessories add versatility to your Proheat Series Heat Gun models. Direct, concentrate or reflect heat to allow more versatile and precise applications for your heat tool.

Note: For 230 Volt Proheat Series Heat Guns destined outside North America, add suffix A1 or A6 to model number to designate plug type.

Example: PH-2400-A1 (Continental Europe & others)
PH-2500-A6 (UK & others)

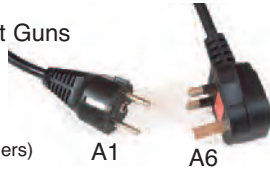

A1 A6



Nozzle Shield
Prevents nozzle contact
Part No. 35026



Bench Stand
To position heat guns for various applications
Part No. 35216



Storage Case
Rugged, plastic storage and carrying case
Fits all Models
Part No. 35351



3-1/2" Spreader Attachment
Spread air over large area
Part No. 35016



1-3/8" Shrink Attachment
Shrink tubing
Part No. 35017



1/2" Specialty Connector Attachment*
Terminate tubing and specialty connectors
Part No. 35292



9/16" Reducer Attachment*
Direct hot air source for desoldering and plastic welding
Part No. 35293



5/16" Pinpoint Attachment*
Pinpoint hot air source for desoldering and plastic welding
Part No. 35294



Get all 5!
Attachment Kit*
Five attachments
Part No. 35309

* Not for PH-1000, PH-1100 PH-2000 or PH-2100
These models do not have electronic closed loop temperature control system

Ecoheat® Heat Gun & Kit

Economical, lightweight, multi-use heat gun



- Two heat settings: 500°F or 1000°F (260°C or 540°C)
- Two fan speeds - Low or High (7 or 9 CFM)
- Resettable thermostat - Automatically protects element against overheating
- Lightweight - 1 lb. - Easy to hold at any angle for long periods of time, eliminates operator fatigue
- Built-in hand guard - Protects hand and fingers. Recessed switch guards against knocks and bumps
- 3-wire grounded cordset - Positive grounding system for user safety
- Thermoplastic housing - For high impact durability
- Built-in stand - Very stable, allows user to set heat gun down in an upright position for hands-free use
- Use to bend and form plastics, dry body fillers, remove decals, spot dry paint, shrink tubing, packaging and more

MODEL NO.	DESCRIPTION
EC-100	500° or 1000°F 260° or 540°C 7 or 9 CFM 120V 60 Hz 10A 1200W cULus
EC-100K	Kit includes EC-100 Heat Gun, 7/8" reducer attachment, 1-1/4" shrink tubing reflector, 1-15/16" and 3-1/8" spreader attachments packed in a durable storage/carrying case cULus
35225	Attachment kit contains 7/8" reducer attachment, 1-1/4" shrink tubing reflector, 1-15/16" and 3-1/8" spreader attachments
35215	Durable storage/carrying case



Kit includes storage case and four specialized nozzle attachments shown left to right: 7/8" reducer, shrink tubing reflector, 1-15/16" spreader and 3-1/8" spreader

Specifications

- Air Volume: 7 or 9 CFM ■ Air Velocity: 720 or 1100 FPM ■ Motor: Permanent Magnet ■ Nozzle Opening: 1.2" I.D., 1.35" O.D. ■ Cordset: 6 ft., 3-wire grounded ■ Dimensions: 8.5" L x 3.2" W x 7.7" H
- Tool Net Weight: 2 lbs. ■ Shipping Weight Tool: 3 lbs. ■ Shipping Weight Kit: 5 lbs.

NOTE: Users should independently evaluate the suitability of the product for their application.

Masterflow® Heat Blower

Heavy-duty, industrial quality, continuous-duty heat blower

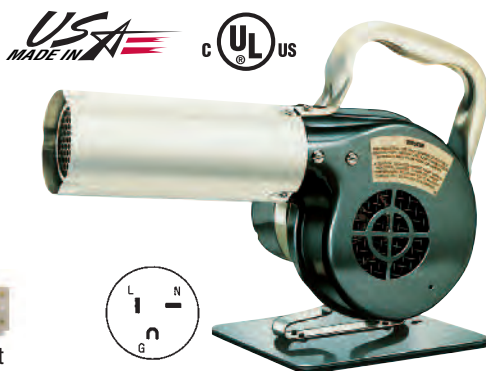

Replacement Heating Element ★ NEMA 5-20P Plug

- 3 models produce 300°F, 500°F or 750°F. High temperatures accommodate many heating, drying & shrinking applications
- High air flow: 47 CFM at 2200 FPM gets job done fast
- Brushless induction type motor for quiet, continuous-duty operation
- Easily replaceable, reinforced, mica-insulated heating element
- Rubber-backed stand permits 90° non-slip adjustability
- Use in any position or mount on equipment
- Ergonomic handle for carrying or portable use
- Mount over conveyor line or on machinery
- Use to heat or dry materials, bend plastics, shrink wrap and more

Specifications

- Air Volume: 47 CFM ■ Air Velocity: 2200 FPM ■ Motor: Induction ■ Nozzle Opening: 1.85" I.D., 2.25" O.D. ■ Dimensions: 12" L x 6" W x 9" H, (AH-301 & AH-302, 9" L x 6" W x 9" H) ■ Base Size: 6" x 6" ■ Cordset: 6 ft., 3-wire grounded ■ Net Weight: 6 lbs. ■ Shipping Weight: 8 lbs.

MODEL NO.	DESCRIPTION	REPLACEMENT ELEMENT
AH-301	300°F 150°C 120V 10.0A 60 Hz 1200W	815 cULus
AH-501	500°F 260°C 120V 14.0A 60 Hz 1680W	30310 cULus
AH-751 ★	750°F 400°C 120V 18.0A 60 Hz 2160W	30312 cULus
AH-302	300°F 150°C 240V 5.2A 60 Hz 1200W	816 cULus
AH-502	500°F 260°C 240V 7.3A 60 Hz 1680W	30311 cULus
AH-752	750°F 400°C 240V 9.4A 60 Hz 2160W	30313 cULus

NOTE: Users should independently evaluate the suitability of the product for their application.

Master-Mite® Heat Gun

Continuous-duty bench-top heating system

- Complete system comes standard with 650°F/343°C heating element, adjustable stand and heat shrink attachment
- Ideal heat & air flow (3.8 CFM), performs benchtop heating jobs without blowing components around the work station
- Quiet-running shaded pole motor, eliminates noisy production areas
- 3 optional easy-to-change plug-in heating elements available: 500°, 650° & 800°F
- Use to activate adhesive, cure epoxies, dry components, melt solder preforms, remove decals, shrink tubing and more

MODEL NO.	DESCRIPTION
10008	650°F/343°C 120V 60Hz 4.5A 475W cULus
10009	650°F/343°C 220V 50Hz 2.0A 450W
10010	800°F/427°C 240V 50Hz 1.9A 450W

Optional Replacement Heating Elements

PART NO.	DESCRIPTION
20012	Blue 500°F/260°C 120V 340W
20013	Silver 650°F/343°C 120V 475W
20014	Black 800°F/427°C 120V 525W
20033	Blue 500°F/260°C 220V 400W
20034	Silver 650°F/343°C 220V 450W
20035	Black 800°F/427°C 220V 500W
20160	Blue 500°F/260°C 240V 400W
20161	Silver 650°F/343°C 240V 450W
20162	Black 800°F/427°C 240V 500W

NOTE: Users should independently evaluate the suitability of the product for their application.



Optional Accessories

PART NO.	DESCRIPTION
30201	Solder preform attachment
40060	Heat shrink attachment
40061	1/4" pinpoint attachment
50675	Bench stand

Specifications

- Air Volume: 3.8 CFM ■ Air Velocity: 700 FPM ■ Motor: Shaded Pole ■ Nozzle Opening: .99" I.D., 1.03 O.D." ■ Cordset: 6 ft., 3-wire grounded ■ Dimensions: 8.8" L x 3.3" W x 7" H ■ Net Weight: 1.7 lbs. ■ Shipping Weight: 3 lbs.

Master-Mite® ESD Heat Gun

Continuous-duty ESD bench-top heating system

- Complete system comes standard with black 800°F/427°C heating element, shrink attachment and adjustable stand
- Totally grounded system with housing surface conductivity 500 ohms square. Conductive housing will not build up or hold a static charge
- Housing helps to shield against EMI & RFI (electromagnetic & radio frequency interference)
- Quiet-running, maintenance free shaded pole motor
- Low velocity air flow will not blow components around the workstation
- 3 optional interchangeable plug-in heating elements available
- Complete line of attachments available
- Use to activate adhesive, cure epoxies, dry components, melt solder preforms, remove decals, shrink tubing and more

MODEL NO.	DESCRIPTION
10012	800°F/427°C 120V 60Hz 4.5A 525W cULus
10014	800°F/427°C 100V 50/60Hz 4.9A 450W

Optional Replacement Heating Elements

PART NO.	DESCRIPTION
20012	Blue 500°F/260°C 120V 340W
20013	Silver 650°F/343°C 120V 475W
20014	Black 800°F/427°C 120V 525W

Optional Accessories

PART NO.	DESCRIPTION
30201	Solder preform attachment
40060	Heat shrink attachment
40061	1/4" pinpoint attachment
50675	Bench stand



Specifications

- Ave. Air Volume: 3.8 CFM ■ Ave. Air Velocity: 700 FPM
- Motor: Shaded Pole ■ Nozzle Opening: .99" I.D., 1.03 O.D." ■ Cordset: 6 ft., 3-wire grounded ■ Dimensions: 8.8" L x 3.3" W x 7" H ■ Housing Static Decay 5000V to <50V <0.01 sec.
- Housing Surface Res. <500 ohms/sq. ■ Net Weight: 1.75 lbs. ■ Shipping Weight: 3 lbs.

NOTE: Users should independently evaluate the suitability of the product for their application.

Econolron® EI-20

Economical, butane-powered soldering iron, flameless heat tool & torch

- Standard with soldering tip, hot air tip and torch tip
- Completely portable, lightweight and easy to handle
- Temperatures up to 2370°F/1300°C
- Ignite tool with flint lighter built into the cap
- Use to pinpoint flameless heat, silver solder, solder and desolder, heat shrink tubing and environmental connectors, strip insulation and cut plastics with hot knife tip, use as an open flame torch and more



MODEL NO.	DESCRIPTION
EI-20	Economical, refillable, butane-powered soldering iron, flameless heat tool and torch

Optional Accessories

PART NO.	DESCRIPTION	PART NO.	DESCRIPTION
35388	2.4mm soldering tip (std.)	35398	2.4mm soldering tip – base req'd
35389	Flameless hot air tip (std.)	35399	Double sharp tip – base req'd
35390	Torch head (std.)	35400	Hot knife tip – base req'd
35391	Hot knife tip (std. EI-20K)	35401	1mm soldering tip
35392	Cap with striker wheel (std.)	35402	3.6mm soldering tip
35393	Flat flame tip	35403	4.8mm soldering tip
35394	Heat shrink attachment	35404	Disc tip, round 1" dia.
35395	Solder head base	35405	Cutter wheel tip
35396	Poly cut tip – base req'd	35406	Scraping blade
35397	Needle tip – base req'd	35407	Popular accessory kit

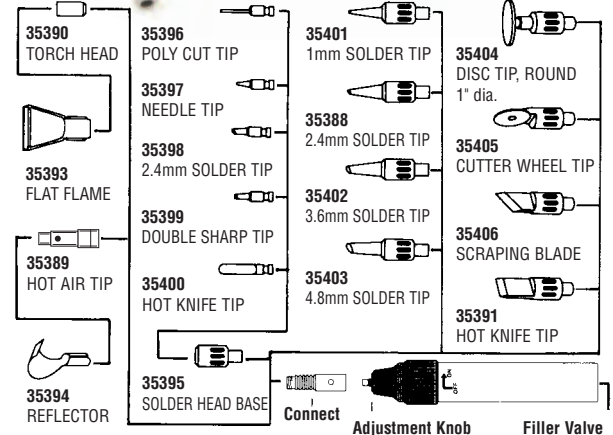

35407 Popular accessory kit includes: 35395 solder head base, 35396 poly cut tip, 35397 needle tip, 35398 2.4mm solder tip, 35399 double sharp tip, 35400 hot knife tip

Refill with Master Ultratane Butane for best performance. (page 28)

NOTE: Users should independently evaluate the suitability of the product for their application.

Specifications	
■ Approx. Soldering Tip Temp.: 395° - 780°F (200° - 420°C)	■ Approx. Hot Air Tip Temp.: 780°F (420°C)
■ Approx. Torch Temp.: 2370°F (1300°C)	■ Equivalent to Electric Iron: 10 to 60 Watt
■ Approx. Operating Time: 60 min.	■ Fuel Tank Capacity: .6 fl. oz. (.01 L)
■ Dimensions: 6.5" L (16.6 cm) w/o cap	■ Net Weight: 1.9 oz.
■ Shipping Weight: 1 lb.	■ Shipped Empty

Econolron® EI-20K

Economical, butane-powered soldering iron, flameless heat tool & torch kit

- Kit contains tool, soldering tip, hot air tip, torch tip, hot knife tip, coil of 60/40 solder, sponge and tool stand packed in rugged plastic storage case
- Completely portable, lightweight and easy-to-handle
- Temperatures up to 2370°F/1300°C
- Ignite tool with flint lighter built into the cap
- Use to pinpoint flameless heat, silver solder, solder and desolder, heat shrink tubing and environmental connectors, strip insulation, cut plastics with hot knife tip, use as an open flame torch and more



MODEL NO.	DESCRIPTION
EI-20K	Economical, refillable, butane-powered soldering iron, flameless heat tool and torch kit

Specifications	
■ Approx. Solder Tip Temp.: 395° - 780°F (200° - 420°C)	■ Approx. Hot Air Tip Temp.: 780°F (420°C)
■ Approx. Torch Tip Temp.: 2370°F (1300°C)	■ Equivalent to Electric Iron: 10 to 60 Watt
■ Approx. Operating Time: 60 min.	■ Fuel Tank Capacity: .6 fl. oz. (.01 L)
■ Tool dimensions: 6.5" L (16.6 cm) w/o cap	■ Kit dimensions: 10" L X 5" W X 2" H (25.4 cm x 12.7 cm X 5 cm)
■ Torch Net Weight: 1.9 oz.	■ Torch Kit Weight: 13.3 oz.
■ Shipping Weight tool: 1 lb.	■ Shipping Weight Kit: 1 lb.
■ Shipped Empty	



See above for more EI-20 accessories

Refill with Master Ultratane Butane for best performance. (page 28)

NOTE: Users should independently evaluate the suitability of the product for their application.

High Performance Ultratip® Technology

Longer tip life, superior thermal conductivity

Master Appliance Ultratorch® heat tools feature Ultratip® soldering tips. Ultratip is the long lasting, oxygen-free, copper based, iron and chrome plated soldering tip with a built-in catalyst, tinned with lead-free solder.

Ultratorch heat tools, with Ultratip Technology, are perfect for use with today's lead-free solders. In fact, Ultratip soldering tips have more than double the iron and chrome plating thickness of our competitors' brass based tips, providing higher thermal conductivity and much longer tip life.

Tips for Lead-Free Hand Soldering

Because hand soldering tends to be done at the end of the line, where the value of a board is at its highest, switching to lead-free solder may have a significant effect on your manufacturing yields, costs and productivity. Simply increasing tip temperature is not the answer because it can cause flux to evaporate before it's had time to activate.

The keys to success here are tip material, tip shape, tip condition, the soldering iron's power output and it's time on the joint.

Ultratip Technology

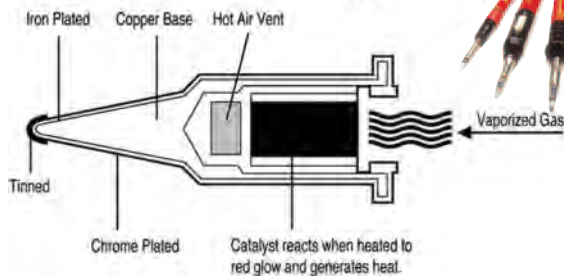

By choosing the tip shape closest to the component you're soldering, and always selecting the largest tip, you'll transfer heat more efficiently at lower settings. We offer a wide selection of tips for your applications.

Since lead-free solder's higher tin content erodes the tip's iron plating faster, Ultratip's thicker iron and chrome plating will significantly extend the tip life. Cleaning your tips often and immediately re-tinning them will also keep them in top condition longer.

Ultratorch® UT-35

Economical, butane-powered, 3-in-1 soldering iron, flameless heat tool & torch

- Standard with Ultratip® soldering tip, hot air tip and protective cap
- 3-in-1 soldering iron, flameless heat tool and torch
- Completely portable, lightweight and easy to use
- Does not require cords, batteries or cartridges, just a lighter
- Adjustable temperature control for temperatures up to 1200°F
- Equivalent to a 20-60 watt electric soldering iron
- Built-in window indicates fuel level
- Refill with Master Ultratane Butane for best performance (page 28)
- Use to pinpoint heat, remove surface mount components, repair vinyl, heat shrink tubing, solder & desolder, spot dry, strip insulation with hot knife and more



MODEL NO.	DESCRIPTION
UT-35	Professional quality, economical, butane-powered soldering iron, flameless heat tool and torch

Optional Accessories

PART NO.	DESCRIPTION
60P-1	.2mm needle preheat soldering tip
60P-1C	1mm tapered needle preheat soldering tip
60P-1.2D	1.2mm chisel preheat soldering tip
60P-1.6D	1.6mm chisel preheat soldering tip
60P-0.5B	.5mm needle preheat soldering tip
60-02	Protective cap (standard)
60-07U	Ejector unit
60-14	Knurled cap nut

PART NO.	DESCRIPTION
60-01-01	1mm diameter tapered needle tip
60-01-02	3.3mm dia. chisel tip (std.)
60-01-03	2mm dia. spade tip
60-01-04	3mm dia. spade tip
60-01-52	5.6mm O.D./4.71mm I.D. hot air tip (std.)
70-01-55	.5"/12.7mm dia. heat shrink attachment
113-01-10	Hot knife tip
60P-K	Preheat hot knife tip



Specifications

- Soldering Tip Temp.: 932°F (500°C) max
- Hot Air Tip Temp.: 1200°F (650°C) max
- Torch Tip Temp.: 2370°F (1300°C) max
- Equivalent to 20 to 60 Watt Electric Iron
- Operating Time: approx 60 min.
- Fuel Tank Capacity: 4 fl. Oz. (12cc)
- Dimensions: 7.3" L (185mm) w/o cap
- Net Weight: 2.6 oz.
- Shipping Weight: 1 lb.
- Shipped Empty

NOTE: Users should independently evaluate the suitability of the product for their application.

Ultratorch® UT-40Si & UT-40SiH

Professional quality, economical, self-igniting soldering iron & flameless heat tool

- Standard with Ultratip® soldering tip, hot air tip and protective cap
- Convenient slide switch ignition system for quick ignition
- Adjustable temperature lever for temperatures up to 1202°F
- Equivalent to a 20-80 watt electric soldering iron
- Compact size, lightweight and completely portable
- Rugged, easy-to-hold plastic body
- Butane-powered with patented gas catalyst reaction system
- Use to pinpoint heat, remove surface mount components, repair vinyl, heat shrink tubing, solder & desolder, spot dry, strip insulation with hot knife and more

MODEL NO.	DESCRIPTION
UT-40Si	Ultratorch soldering iron/flameless heat tool
UT-40SiH	Ultratorch w/hot air tip & shrink attachment

Optional Accessories

PART NO.	DESCRIPTION
	ULTRATIP SOLDERING TIPS
91-01-01	1mm wide chisel soldering tip
91-01-02	2.4mm wide chisel soldering tip (std. UT-40Si, UT-40SiK)
91-01-03	2mm wide chisel soldering tip
91-01-04	5mm wide chisel soldering tip
	HOT AIR TIPS AND SHRINK ATTACHMENT
91-01-50	1.6mm wide hot air tip
91-01-52	4.7mm wide hot air tip (std. all models)
70-01-55	.5"/12.7mm dia. .75"/19mm wide heat shrink attachment (std. UT-40SiH, UT-40SiK) (requires 91-01-52)
	HOT KNIFE TIP
91-01-53	Standard with UT-40SiK
	PROTECTIVE CAP & CARRYING STRAP
91-02	Protective cap (std. all models)
70-52U	Carrying strap

Specifications

- See UT-40SiK for tool specifications



Soldering Tips

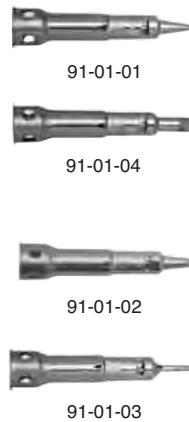

Hot Air Tips

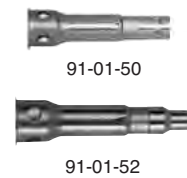

Heat Shrink Attachment



Protective Cap



Hot Knife Tip



Carrying Strap



NOTE: Users should independently evaluate the suitability of the product for their application.

Ultratorch® UT-40SiK

Professional quality, economical, self-igniting soldering iron & flameless heat tool kit

- Kit contains Ultratorch, Ultratip® soldering tip, hot air tip, hot knife tip, shrink attachment, cap, sponge and stand, packed in a rugged plastic storage/carrying case
- Convenient slide switch ignition system for quick ignition
- Adjustable temperature lever for temperatures up to 1202°F
- Equivalent to a 20-80 watt electric soldering iron
- Compact size, lightweight and completely portable, features a rugged, easy-to-hold plastic body
- Patented gas catalyst reaction system
- Use to pinpoint heat, remove surface mount components, repair vinyl, heat shrink tubing, solder & desolder, spot dry, strip insulation with hot knife and more

MODEL NO.	DESCRIPTION
UT-40SiK	Ultratorch Kit

Specifications

- Approx. Soldering Tip Temp. 840°F (450°C) ■ Approx. Hot Air Tip Temp.: 1202°F (650°C) ■ Equivalent to Electric Iron: 20 to 80 Watt
- Approx. Operating Time: 1.3 hrs. ■ Fuel Tank Capacity: .5 fl. oz
- Dimensions: 8.3" L (208mm) ■ Tool Net Weight: 2.6 oz. ■ Shipping Weight Tool: 1 lb. ■ Shipping Weight Kit: 2 lbs. ■ Shipped Empty

NOTE: Users should independently evaluate the suitability of the product for their application.



See above for more UT-40SiK accessories. Refill with Master Ultratane Butane for best performance. (page 28)

Ultratorch® UT-50

Professional quality, pen-sized butane-powered soldering iron, flameless heat tool and torch

- Standard with Ultratip® soldering tip, hot air tip and protective cap
- Pen-sized heat tool fits in your shirt pocket for absolute portability
- Aluminum fuel tank with viewing window to indicate fuel level
- Optional tips and accessories available
- Operates for approximately 20 minutes on a full charge
- Use to pinpoint heat, remove surface mount components, repair vinyl, heat shrink tubing, solder and desolder, spot dry, torch materials and more

MODEL NO.	DESCRIPTION
UT-50	Butane-powered soldering iron, flameless heat tool and torch

Optional Accessories

PART NO.	DESCRIPTION
71-01-01	1mm dia. tapered needle tip
71-01-02	2.4mm dia. chisel tip (standard)
71-01-03	2mm dia. spade tip
71-01-04	3mm dia. spade tip
71-01-50	1.5mm dia. hot air tip
71-01-52	4.7mm dia. hot air tip (standard)
70-01-55	.5"/12.7mm dia., .75"/19mm wide heat shrink attachment
70-35	Ejector spanner wrench
70-52U	Carrying strap

Specifications

- Approx. Soldering Tip Temp.: 392° - 842°F (200° - 450°C)
- Approx. Hot Air Tip Temp.: 806°F (430°C) ■ Approx. Torch Tip Temp.: 2372°F (1300°C) ■ Equivalent to Electric Iron: 20 to 60 Watt ■ Approx. Operating Time: 20 min. ■ Fuel Tank Capacity: .2 fl. oz. (6 cc)
- Dimensions: 6.5" L (165mm) ■ Net Weight: 2.2 oz
- Shipping Weight: 1 lb. ■ Shipped Empty

NOTE: Users should independently evaluate the suitability of the product for their application.



71-01-02 tip

71-01-52



71-01-01



71-01-02



71-01-03



71-01-04



71-01-50



71-01-52



70-01-55



70-35



70-52U

Refill with Master Ultratane Butane for best performance. (page 28)

Ultratorch® UT-100SiEA

Self-igniting butane-powered flameless heat tool with fan assisted air flow

- Eliminates scorching and burning damage to shrink tubing during installation
- Variable temperature 302° - 572°F (150° - 300°C) with fan
- Enhanced Air Flow volume is 4 times greater with fan
- Variable temperature 482° - 932°F (250° - 500°C) without fan
- Butane-powered and completely portable/cordless, for use where no electrical outlets are available
- Built-in battery-powered motor uses 4 standard AA batteries
- Built-in LED light provides lighting in dark locations
- Built-in stand is convenient for safety and hands-free use
- Ideal for terminating shrink tubing and specialty connectors 10mm I.D. or less
- Use with or without enhanced air flow and with or without shrink attachment
- Ergonomic handle makes tool easy to use over an extended period of time
- UL & TUV Listed

MODEL NO.	DESCRIPTION
UT-100SiEA	Butane-powered flameless heat tool with fan assisted airflow

Specifications

- Approx. Hot Air Temp.with fan: 302° - 572°F (250° - 500°C)
- Approx. Hot Air Temp.without fan: 482° - 932°F (150° - 300°C)
- Approx. Operating Time: 100 min. ■ Fuel Tank Capacity: 1 fl. oz. (28 cc)
- Dimensions: 10.25" L (242mm) 8.25" H (242mm) ■ Hot Air Tip Opening: 8mm dia. ■ Net Weight: 11.25 oz. ■ Shipping Weight: 1 lb.
- Shipped Empty

NOTE: Users should independently evaluate the suitability of the product for their application.

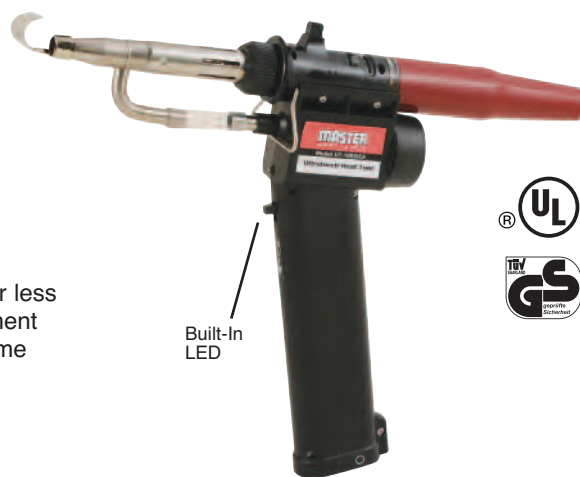

Built-In LED



Ultratorch® UT-100 & UT-100-TC

Butane-powered soldering iron, flameless heat tool and torch

- Triple function soldering iron, flameless heat tool and brazing torch
- Features oxygen-free, copper based Ultratip® soldering tips, with thick iron and chrome plating for long life and high thermal conductivity
- Cordless and completely portable, ready-to-use in 30 seconds
- Adjustable temperature control
- Soldering temperature up to 932°F, ideal for use with today's lead-free solder
- Hot air temperature up to 1202°F, perfect for Solderseal™ environmental "heat and seal" connectors
- Torch temperatures up to 2372°F/1260°C
- Sturdy metal tank with fuel viewing window holds enough fuel for 2 hours of operation
- Refill with Master Ultratane Butane for best performance (page 28)
- Use to pinpoint heat, remove surface mount components, repair vinyl, heat shrink tubing, solder and desolder, spot dry, torch materials and more
- Optional accessories available and interchangeable between UT-100 & UT100Si (See page 20)



UT-100-TC

Ultratorch Professional Kit:

Includes heat tool, 3 soldering tips, flameless hot air and open flame torch tips, hot knife, solder, wire cutter, needle nose pliers and cap in a rugged storage/carrying case



70-01-02 tip

70-35

70-07TU

70-01-52

70-01-55

UT-100

Ultratorch

MODEL NO.	DESCRIPTION
UT-100-TC	Includes Ultratorch, three Ultratip soldering tips: 70-01-02, 70-01-05, 70-01-11, hot air tip: 70-01-52, shrink attachment: 70-01-55, hot knife: 70-01-16, torch ejector 70-07TU, open end wrench, ejector, sponge, cap, solder, wire cutter and needle nose pliers packed in a rugged plastic carrying case
UT-100	Includes Ultratorch, Ultratip soldering tip: 70-01-02, hot air tip: 70-01-52, shrink attachment: 70-01-55, torch ejector 70-07TU, open end wrench, ejector, sponge and steel case

See page 20 for more tips & accessories

Specifications

- Approx. Soldering Tip Temp.: 392° - 932°F (200° - 500°C)
- Approx. Hot Air Tip Temp.: 1112°F (600°C) ■ Approx. Torch Tip Temp. 2372°F (1260°C) ■ Equivalent to Electric Iron: 20 to 80 Watt ■ Approx. Operating Time: 120 min. ■ Fuel Tank Capacity: 1 fl. oz. (28 cc)
- Tool dimensions: 9.5" L (242mm) ■ Tool Net Weight: 3.7 oz.
- UT-100 Shipping Weight: 1 lb. ■ UT-100-TC Shipping Weight: 3 lbs.
- Shipped Empty

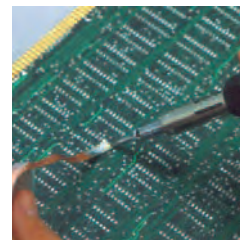

Solder



Flameless Heat



Torch

NOTE: Users should independently evaluate the suitability of the product for their application.

Ultratorch® UT-100 & UT-100Si Tips and Accessories

For use with UT-100 & UT-100Si Ultratorches

- Oxygen-free, copper based Ultratip® soldering tips have thick iron and chrome plating for long life and high thermal conductivity
- Ultratips are manufactured using a patented process which produces uniform iron and chrome plating thickness
- Ultratip® soldering tips feature leading-edge combustion chamber/exhaust port design
- All tips pre-tinned with lead-free solder
- Optional accessories interchangeable between all UT-100 & UT-100Si models

PART NO.	DESCRIPTION
	ULTRATIP SOLDERING TIPS
70-01-01	1mm dia. tapered needle soldering tip
70-01-02	3.3mm dia. chisel soldering tip (std., all models)
70-01-03	2mm dia. spade soldering tip
70-01-04	3mm dia. spade soldering tip
70-01-05	0.5mm dia. tapered needle soldering tip (std. UT-100-TC, UT-100Si-TC)
70-01-06	2mm dia. micro spade soldering tip
70-01-07	0.5mm dia. square tapered pyramid soldering tip
70-01-08	2mm dia. 35° spade soldering tip
70-01-09	3mm dia. 35° spade soldering tip
70-01-10	1mm dia. offset tapered needle soldering tip
70-01-11	8mm dia. high powered chisel soldering tip (std., UT-100-TC, UT-100Si-TC)
70-01-12	3mm dia. high powered round head needle tip
70-01-13	.5mm dia. high powered long tapered chisel tip
70-01-15	7mm dia. 45° spade soldering tip
	HOT KNIFE TIP
70-01-16	Hot knife tip (std. UT-100-TC, UT-100Si-TC, UT-100SiHK)
	HOT AIR TIPS
70-01-50	2.5 O.D./1.59 I.D. (mm) hot air tip
70-01-51	4.25 O.D./3.3 I.D. (mm) hot air tip
70-01-52	5.7 O.D./4.9 I.D. (mm) hot air tip (std. all models)
70-01-53	8.0 O.D./6.9 I.D. (mm) hot air tip
	ACCESSORIES
70-01-54	.75"/19mm dia., .825"/22.2mm wide heat shrink attachment
70-01-55	.5"/12.7mm dia., .75"/19mm wide heat shrink attachment (std. all models)
70-02	Protective cap (std. UT-100, UT-100-TC)
70-07TU	Ejector, torch (std. UT-100, UT-100-TC)
70-35	Ejector spanner wrench
70-37U	Tip cleaner sponge (std. with UT-100, UT-100SiK)
70-40U	Metal storage box (std. with UT-100, UT-100SiK)
70-43	Tool holder (std. with UT-100, UT-100SiK)
70-52U	Carrying strap
90-02	Protective cap (std. UT-100Si, UT-100Si-TC)
80-40	Open end wrench (std. UT-100Si, UT-100SiK and UT-100Si-TC)
	ADAPTER
70-01-14	8.4 tip adapter (4mm dia. x .7 pitchmm)

NOTE: Users should independently evaluate the suitability of the product for their application.

Soldering Tips



70-01-01



70-01-02



70-01-03



70-01-04



70-01-05



70-01-06



70-01-07



70-01-08



70-01-09



70-01-10



70-01-11



70-01-12



70-01-13



70-01-15

Hot Knife Tip



70-01-16



Adapter

70-01-14

Hot Air Tips



70-01-50



70-01-51



70-01-52



70-01-53

Accessories



70-02



70-35



70-37U



70-40U



70-43



70-52U



70-01-54



70-01-55



80-40



90-02

Ultratorch® UT-100Si, UT-100SiK & UT-100Si-TC

Self-igniting butane-powered soldering iron and flameless heat tool

- Dual function, self-igniting soldering iron and flameless heat tool
- Features oxygen-free, copper based Ultratip® soldering tips, with thick iron and chrome plating for long life and high thermal conductivity
- Cordless and completely portable, ready-to-use in 30 seconds
- Self-ignition with push button for fast, easy starting
- Adjustable temperature control
- Soldering temperature up to 932°F, ideal for use with today's lead-free solder
- Hot air temperature up to 1202°F, perfect for Solderseal™ environmental "heat and seal" connectors
- Sturdy metal tank with fuel viewing window holds enough fuel for 2 hours of operation
- Contains everything needed to heat shrink tubing and specialty connectors, remove surface mount components, solder and desolder, repair vinyl, spot dry and cut materials
- Optional accessories available and interchangeable between UT-100 & UT-100Si (See page 20)



**UT-100Si-TC
Ultratorch Professional Kit:**
Includes heat tool, 3 soldering tips and flameless hot air tip, hot knife, solder, wire cutter, needle nose pliers and cap in a rugged storage/carrying case

MODEL NO.	DESCRIPTION
UT-100Si-TC	Includes Ultratorch, three Ultratip soldering tips: 70-01-02, 70-01-05, 70-01-11, hot air tip: 70-01-52, shrink attachment: 70-01-55, hot knife: 70-01-16, open end wrench, ejector, sponge, cap, solder, wire cutter and needle nose pliers packed in a rugged plastic carrying case
UT-100SiK	Includes Ultratorch, Ultratip soldering tip: 70-01-02, hot air tip: 70-01-52, shrink attachment: 70-01-55, open end wrench, ejector, sponge and steel case
UT-100Si	Includes Ultratorch, Ultratip soldering tip: 70-01-02, hot air tip: 70-01-52, shrink attachment: open end wrench, ejector and cap
UT-100Si-HK	Includes Ultratorch, hot knife: 70-01-16, open end wrench, ejector and cap

UT-100SiK Ultratorch Kit



UT-100Si Ultratorch



NEW!

UT-100Si-HK Ultratorch



See page 20 for more accessories

Specifications

- Approx. Soldering Tip Temp.: 482° - 932°F (250° - 500°C) ■ Approx. Hot Air Tip Temp.: 1202°F (650°C) ■ Equivalent to Electric Iron: 20 to 80 Watt ■ Approx. Operating Time: 120 min. ■ Fuel Tank Capacity: 1 fl. oz. (28 cc) ■ Dimensions: 10.3" L (260mm) ■ Tool Net Weight: 5.5 oz. (100 g) ■ Shipping Weight UT-100Si: 1 lb. ■ Shipping Weight UT-100SiK: 2 lbs. ■ Shipping Weight UT-100Si-TC: 3 lbs. ■ Shipped Empty



Refill with Master Ultratane Butane for best performance. (page 28)

NOTE: Users should independently evaluate the suitability of the product for their application.

Ultratorch® UT-200 & UT-200Si

Butane-powered soldering iron/heat tools

2.6 Hour Run Time



UT-200

- Operates as a soldering iron, flameless heat tool and butane torch
- Standard with Utratip® soldering tip, hot air tip, shrink attachment and protective cap
- Equivalent to 200 watt max. electric soldering iron
- Adjustable temperatures up to 2372°F/1260°C
- High power (BTU's) makes it perfect for heavy-duty service and maintenance
- Sturdy metal tank holds enough fuel for 2.6 hours of operation at middle temperature setting
- Refill with Master Ultratane Butane for best performance (page 28)
- Use to pinpoint heat, heat shrink tubing, solder and desolder, strip insulation, terminate specialty connectors, torch materials and more
- Optional accessories interchangeable between UT-200, UT-200Si and UT-300Si models

2.6 Hour Run Time



UT-200Si

- Operates as a soldering iron and flameless heat tool
- Self-ignition with push button for fast, easy starting
- Standard with Utratip® soldering tip, hot air tip, shrink attachment, spanner and open end wrenches, and protective cap
- Equivalent to 200 watt max. electric soldering iron
- Adjustable temperatures up to 1004°F/540°C
- High power (BTU's) makes it perfect for heavy-duty service and maintenance
- Sturdy metal tank holds enough fuel for 2.6 hours of operation at middle temperature setting
- Refill with Master Ultratane Butane for best performance (page 28)
- Use to pinpoint heat, heat shrink tubing, solder and desolder, strip insulation, terminate specialty connectors, torch materials and more
- Optional accessories interchangeable between UT-200, UT-200Si and UT-300Si models



MODEL NO.	DESCRIPTION
UT-200	Butane-powered soldering iron, heat tool and torch with soldering tip, hot air tip, shrink attachment and protective cap
UT-200Si	Self-igniting, butane-powered soldering iron/heat tool, with soldering tip, hot air tip, shrink attachment and protective cap

See page 23 for more accessories

Specifications

- Approx. Soldering Tip Temp.: 482° - 986°F (250° - 530°C)
- Approx. Hot Air Tip Temp.: 1004°F (540°C) ■ Approx Torch Temp: UT-200 2372°F (1260°C) ■ Fuel Tank Capacity: 2.2 fl. oz. (63 cc)
- Dimensions: 11.9" L (300mm) ■ Net Weight: 9 oz.
- Shipping Weight: 1 lb. ■ Shipped Empty

NOTE: Users should independently evaluate the suitability of the product for their application.

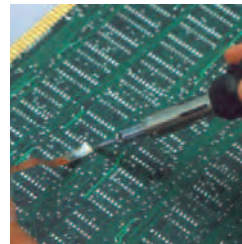

Solder



Desolder



Torch
(UT-200 only)



Flameless Heat

Ultratorch® UT-300Si

Butane-powered pistol grip soldering iron and flameless heat tool



72-01-11 tip

3 Hour Run Time

78-02

72-01-52

72-01-54

- Operates as a soldering iron or flameless heat tool
- Standard with Ultratip® soldering tip, hot air tip, shrink attachment and protective cap
- Convenient slide switch ignition system for quick ignition
- Pistol grip design, great for extended use applications
- High performance soldering tip can reach approx. 932°F/500°C
- Built-in window indicates fuel level
- High capacity, can run up to 3 hours on a full tank
- Use to pinpoint heat, heat shrink tubing, solder and desolder, strip insulation, terminate specialty connectors and more
- Optional accessories interchangeable between UT-200, UT-200Si and UT-300Si models

MODEL NO.	DESCRIPTION
UT-300Si	Butane-powered soldering iron and flameless heat tool

Specifications

- Approx. Soldering Tip Temp.: 932°F (500°C)
- Approx. Hot Air Tip Temp.: 1112°F (600°C)
- Equivalent to Electric Iron: 200 Watt max.
- Approx. Operating Time: 180 min.
- Fuel Tank Capacity: 2.7 fl. oz. (80cc)
- Dimensions: 7.3" H x 6.8" L (186mm H x 172mm W)
- Net Weight: 9.9 oz.
- Shipping Weight: 2 lbs.
- Shipped Empty

Refill with Master Ultratane Butane. (page 28)

NOTE: Users should independently evaluate the suitability of the product for their application.

Ultratorch® UT-200, UT-200Si & UT-300Si Tips and Accessories

For use with UT-200, UT-200Si & UT-300Si Ultratorches

- Oxygen-free, copper based Ultratip® soldering tips have thick iron and chrome plating for long life and high thermal conductivity
- Ultratips are manufactured using a patented process which produces a uniform iron and chrome plating thickness
- Ultratip® soldering tips feature leading-edge combustion chamber/exhaust port design
- All tips are pre-tinned with lead-free solder
- Optional accessories interchangeable between UT-200, UT-200Si and UT-300Si models

PART NO.	DESCRIPTION
ULTRATIP SOLDERING TIPS	
72-01-01	3mm dia. tapered needle soldering tip
72-01-02	10mm dia. chisel soldering tip (std. UT-200, UT-200Si)
72-01-03	4mm dia. spade soldering tip
72-01-05	1mm dia. tapered needle soldering tip
72-01-06	4mm dia. micro spade soldering tip
72-01-07	1.5mm dia. tapered pyramid soldering tip
72-01-11	7mm dia. chisel soldering tip (std. UT-300Si)
72-01-12	4mm dia. chisel soldering tip
72-01-13	12.5mm dia. 45° spade soldering tip
HOT AIR TIPS	
72-01-51	5.6 O.D./3.6 I.D. (mm) hot air tip
72-01-52	8.6 O.D./6.6 I.D. (mm) hot air tip (std. all models)
72-01-53	11.5 O.D./9.7 I.D. (mm) hot air tip
ACCESSORIES	
72-01-54	1"/25.4mm dia., .1"/25.4mm wide heat shrink attachment (std. UT-300Si)
72-01-55	1.25"/32mm dia., 1.25"/32mm heat shrink attachment (std. UT-200, UT-200Si)
72-02	Protective cap (std. UT-200, UT-200Si)
72-52U	Carrying strap
80-35	Ejector spanner wrench (std. UT-200Si)
80-40	Open end wrench (std. UT-200, UT-200Si)
78-02	Protective cap (std. UT-300Si only)
ADAPTER	
72-01-14	Adapter (5mm dia. x 8mm pitch) tip

Soldering Tips



72-01-01



72-01-02



72-01-03



72-01-05



72-01-06



72-01-07



72-01-11



72-01-12



72-01-13



72-01-14

Hot Air Tips



72-01-51



72-01-52



72-01-53

Accessories

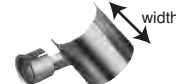

72-01-54 (32mm wide)
72-01-55 (27mm wide)



72-02



72-52U



80-35



80-40



78-02

NOTE: Users should independently evaluate the suitability of the product for their application.

Microtorch MT-5

Pocket-sized, self-igniting butane-powered microtorch



- Compact pocket size, fits easily into pocket or tool kit
- Quick starting self-igniting piezo electric ignition eliminates the need for lighters or matches
- Flame resists wind and moisture and is perfect for outdoor use
- Adjustable flame height for low and high temperatures up to 2500°F/1300°C blue flame
- Safety lock and attached safety cap prevent unintentional ignition
- Hands-free mode
- Refill with Master Ultratane Butane for best performance (page 28)
- Meets Consumer Products Safety Commission (CPSC) Child Safety Requirements
- Use to heat and ignite materials, repair glass, shrink tubing, solder and desolder, terminate specialty connectors and more

MODEL NO.	DESCRIPTION
MT-5	Microtorch, pocket-sized

Specifications

- Approx. Flame Temp. 2500°F
- Fuel Tank: Plastic, Built-in, Refillable
- Approx. Run Time: 20 min. @ max. setting
- Dimensions: 2.9" H x 1.3" W x .9" D
- Net Weight: 1.7 oz.
- Shipping Weight: 1 lb.
- Shipped Empty

NOTE: Users should independently evaluate the suitability of the product for their application.

Microtorch MT-11 & MT-11K

Microtorch, palm-sized, shipped without fuel



- Built-in self-igniting system with safety lock
- Temperatures up to 2500°F/1300°C
- Compact palm-sized, perfect for tool kits and field service kits
- Adjustable wind-resistant flame
- Replaceable, refillable "fuel cell" (included) (page 28)
- Meets Consumer Products Safety Commission (CPSC) Child Safety Requirements
- Kit includes microtorch with empty fuel cell and 15/16 oz. can of butane packed in single shipper carton with proper D.O.T. markings
- Ships via ground transportation without hazmat charges
- Use to heat materials, ignite materials, pinpoint torch, shrink tubing, solder and desolder, terminate specialty connectors and more

MODEL NO.	DESCRIPTION
MT-11	Microtorch, palm-sized, shipped without fuel
MT-11K	Microtorch with 15/16 oz. can of butane (10448)
RC-31	Replacement fuel cell 2 pack (see page 28)

Specifications

- Approx. Flame Temp.: 2500°F
- Approx. Run Time: 20 min. @ max. setting
- Fuel Tank: Refillable Fuel Cell
- Dimensions: 4.3" H x 2.5" W x 1" D
- Net Weight: 2.1 oz.
- Shipping Weight: 1 lb.
- Shipping Weight Kit: 2 lbs.

NOTE: Users should independently evaluate the suitability of the product for their application.

Microtorch MT-30

Low profile, table-top Microtorch with stable base

- Built-in self-igniting system with safety lock that ensures the switch is not turned on when not in use
- Wide, heavy, stable base is perfect for bench-top use
- Durable self-contained, refillable metal fuel tank
- Large capacity fuel tank for 60-minute continuous run time on full charge
- Adjustable broad or pinpoint flame with temperatures up to 2500°F/1300°C
- Refill with Master Ultratane Butane for best performance (page 28)
- Use for laboratory applications, to heat materials, shrink tubing, terminate specialty connectors, work with silver wire, add patina to copper jewelry, as a pinpoint torch and more

NEW!



CE



MODEL NO.	DESCRIPTION
MT-30	Microtorch, low profile table-top

Specifications

- Approx. Flame Temp.: 2500°F ■ Approx. Run Time: 60 min. @ max. setting
- Fuel Tank: Metal, Built-in, Refillable
- Dimensions: 5.1" L x 3" W x 3.5" D
- Net Weight: 12 oz. ■ Shipping Weight: 1 lb. ■ Shipped Empty

NOTE: Users should independently evaluate the suitability of the product for their application.

Mini-Triggertorch MT-70 & MT-70P

Self-igniting butane-powered heat tool

- Gas adjustment wheel provides adjustable, long blue torch flame with temperatures up to 2500°F/1300°C
- Self-igniting piezo electric ignition is easy to start and eliminates the need for lighter or matches
- Incorporates "trigger" switch with "pulldown" lock to meet Consumer Products Safety Commission (CPSC) Child Safety Requirements
- "Hands-free" slide lock for continuous use and instant off operation
- Ergonomic handle design ensures a non-slip grip
- Removable base for table-top or hand-held use
- 60 minute continuous run time with a full charge
- Durable self-contained, refillable plastic fuel tank
- Refill with Master Ultratane Butane for best performance (page 28)
- Unique shutter lever to easily extinguish ignition flame if using optional soldering or hot air tip attachments
- Use to heat parts, ignite materials, melt plastic, shrink tubing, solder & desolder, terminate specialty connectors and more

NEW!



MODEL NO.	DESCRIPTION
MT-70	Triggertorch, mini, table-top
MT-70P	MT-70 Mini-Triggertorch & MT-11 Palm-sized Microtorch

Specifications

- Approx. Flame Temp.: 2500°F ■ Approx. Run Time: 60 min. @ max. setting
- Fuel Tank: Plastic, Built-in, Refillable
- MT-70 dimensions: 5.5" L x 3.8" H x 1.3" W
- Net Weight: 6.4 oz. ■ Shipping Weight: 1 lb.
- MT-70P Shipping Weight: 2 lbs. ■ Shipped Empty

NOTE: Users should independently evaluate the suitability of the product for their application.

Microtorch MT-51, MT-51B & MT-51H

Hand-held or table-top butane-powered microtorch



MT-51



- Built-in self-igniting system with safety lock
- “Hands-free” slide lock for continuous use and instant off operation
- Durable self-contained, refillable plastic fuel tank
- Wide, stable base is perfect for hands-free use
- Temperatures up to 2500°F/1300°C
- 2 hour continuous burn time, perfect for continuous heat applications
- Adjustable broad or pinpoint flame
- Refill with Master Ultratane Butane for best performance (page 28)
- Meets Consumer Products Safety Commission (CPSC) Child Safety Requirements
- Use to heat materials, ignite materials, pinpoint torch, shrink tubing, solder and desolder, terminate specialty connectors and more



MT-51B ships via ground transportation with no Hazmat charges



MT-51B

Included butane canister provides three fuel refills



Butane 10448



MT-51H

Includes Hot Air Tip & Heat Reflector for heat shrink applications

Hot Air Tip 35387

Heat Shrink Attachment 35394



Heat Shrinking

MODEL NO.	DESCRIPTION
MT-51	Microtorch, table-top
MT-51B	Microtorch, table-top with 1 ⁵ / ₁₆ oz. butane (10448)
MT-51H	Microtorch, table-top includes hot air tip (35387) and 1" diameter heat shrink attachment (35394)

Specifications

- Approx. Flame Temp.: 2500°F
- Approx. Run Time: Two Hours
- Fuel Tank: Plastic, Built-in, Refillable
- Dimensions: 6.1" H x 3" W x 1.3" D
- Net Weight: 5 oz.
- Shipping Weight: 1 lb.
- Shipped Empty

NOTE: Users should independently evaluate the suitability of the product for their application.

Triggertorch™ MT-76 & MT-76K

Professional quality, hand-held or table-top, butane-powered, self-igniting triggertorch, soldering iron and flameless heat tool

- Gas adjustment wheel provides adjustable, long blue torch flame with temperatures up to 2500°F/1300°C
- Self-igniting piezo electric ignition is easy to start and eliminates the need for lighter or matches
- MT-76 includes soldering tip and hot air tip for soldering up to 752°F/400°C and heating up to 932°F/500°C
- Kit includes triggertorch, removable stand, 5" wire cutter, 5" needle nose pliers, soldering tip, hot air tip, shrink attachment, polyfoam cutter, hot knife tip, roll 60/40 solder, and stand with sponge packed in a durable plastic storage/carrying case
- Incorporates "trigger" switch with "pulldown" lock to meet Consumer Products Safety Commission (CPSC) Child Safety Requirements
- "Hands-free" slide lock for continuous use and instant off operation
- Unique shutter lever to easily extinguish ignition flame when using soldering or hot air tip attachments
- Ergonomic handle design ensures a non-slip grip
- Removable base for table-top or hand-held use
- Durable self-contained, refillable plastic fuel tank with capacity for 2 hour run time
- Refill with Master Ultratane Butane for best performance (page 28)
- Use to heat parts, ignite materials, melt plastic, shrink tubing, solder & desolder, terminate specialty connectors and more



MT-76K, 4 tools in 1

Open Flame Torch, Soldering Iron, Flameless Hot Air and Hot Knife

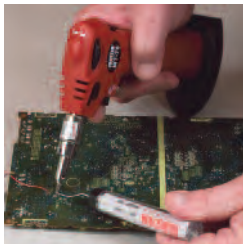

Solder



Flameless Hot Air



2 Hour Run Time



Soldering Tip 35386 Hot Air Tip 35387

MT-76, 3 tools in 1

Open Flame Torch, Soldering Iron and Flameless Hot Air

MODEL NO.	DESCRIPTION
MT-76	Triggertorch with table-top stand, soldering tip (35386) & hot air tip (35387)
MT-76K	Triggertorch kit with table-top stand, soldering tip (35386), hot air tip (35387), hot knife tip (35400), shrink attachment (35394), polyfoam cutter (35396), 5" wire cutter, 5" needle nose pliers, 60/40 solder and sponge packed in a durable plastic case

Specifications

- Approx. Flame Temp.: 2500°F
- Approx. Run Time: Two Hours
- Fuel Tank: Plastic, Built-in, Refillable
- Dimensions: 6.5"H x 3.8"W x 1.3"D
- MT-76 Weight: 8 oz.
- Shipping Weight Tool: 1 lb.
- Shipping Weight Kit: 3 lbs.
- Shipped Empty

NOTE: Users should independently evaluate the suitability of the product for their application.

General Industrial Torch GT-70

Hand-held or table-top, butane-powered, heavy-duty, general industrial torch



- Self-igniting piezo electric ignition is easy to start and eliminates need for lighter or matches
- Large capacity, built-in, durable, metal fuel tank for 30-minute continuous run time on a full charge
- Large sized adjustable blue flame accommodates heavy-duty industrial applications with temperatures up to 2500°F/1300°C
- Safety lock prevents unintentional ignition, locks for storage
- Removable base for table-top or hand-held use
- Refill with Master Ultratane Butane for best performance
- Meets Consumer Products Safety Commission (CPSC) Child Safety Requirements
- Use to braze with special alloy welding rods, heat and bend thin metals, loosen rusted bolts, pop dents out of metal, shrink and terminate heavy wall adhesive-lined tubing, solder and desolder and more

MODEL NO.	DESCRIPTION
GT-70	General Industrial Torch

Specifications

- Approx. Flame Temp.: 2500°F
- Approx. Run Time: 30 Min.
- Fuel Tank: Metal, Built-in, Refillable
- Dimensions: 6.5" H x 5" W x 1.8" D
- Net Weight: 10.6 oz.
- Shipping Weight: 1 lb.
- Shipped Empty

NOTE: Users should independently evaluate the suitability of the product for their application.

Ultratane® Butane

For use with all Master butane-powered products



51773
5 1/8 oz.



10448
1 5/16 oz.



RC-31



- Recommended fuel for all Master butane-powered products
- Triple-refined formula reduces clogging of filters
- Special vapor pressure promotes consistent ignition
- Contains no CFC's
- Available in two aerosol canister sizes: 5 1/8 oz. (145 gm) and 1 5/16 oz. (26.5 gm) and refillable RC-31 fuel cells
- Model 10448 has proper D.O.T. markings to ship via ground transportation without hazardous material charges
- Model 51773 ships via ground transportation with hazardous material charges

MODEL NO.	DESCRIPTION
51773	5 1/8 oz. (145 gram) canister with universal tip adapter
10448	1 5/16 oz. (26 gram) canister with universal tip adapter
RC-31	Refillable butane fuel cell. Carded 2 per card

RC-31 Fuel Cell (for use with MT-11)

- RC-31 has proper D.O.T. markings to ship via ground transportation without hazardous material charges
- RC-31 is not considered a cigarette lighter
- RC-31 is a refillable fuel cell to replace pre-childproof lighters
- Refillable with Master Ultratane® Butane 51773 and 10448

NOTE: Users should independently evaluate the suitability of the product for their application.

PortaPro® Glue Gun

Cordless, butane-powered hotmelt glue gun

- Completely portable, lets you work almost anywhere
- Industrial power and durability
- One touch, fast piezo ignition
- Reaches operating temperature in less than 4 minutes
- 140 minutes continuous run time with a full charge
- Fuel view window indicates fuel level
- Refill with Master Ultratane Butane for best performance (page 28)
- Built-in fold away stand
- Unlimited versatility
- Use to bond corrugated materials, chipboard and wood, fasten plastics, light metals, textiles, shock absorbent packaging, capacitors, resistors, soldered parts, electrical potting/staking parts on PC boards and jumper wires, reseal products during packaging, and glue down carpeting



GG-100 PortaPro Glue Gun

Includes glue gun, general purpose tip (35408) and four general purpose 6" glue sticks

MODEL NO.	DESCRIPTION
GG-100	PortaPro Glue Gun
GG-100K	PortaPro Glue Gun Kit

Accessories

PART NO.	DESCRIPTION
35408	Standard general purpose tip
35409	Needle extension tip
35410	Diagonal cut extension tip
35411	Spreader extension tip
35412	12 General purpose glue sticks 12" long x 1/2" dia.
35413	12 Carton closing glue sticks 12" long x 1/2" dia.
35414	12 Woodworking glue sticks 12" long x 1/2" dia.
35454	20 lbs. General purpose glue sticks (approx. 290 sticks)
35455	20 lbs. Carton closing glue sticks (approx. 290 sticks)
35456	20 lbs. Woodworking glue sticks (approx. 290 sticks)

Contact Master Appliance for glue stick specifications



Continuous use operating times up to 140 minutes



Cordless operation is fast and convenient



GG-100K PortaPro Glue Gun Kit

includes: glue gun, 4 tips, 8 general purpose 6" long glue sticks & manual packed in a rugged storage case. Case has slot to hold Master Butane (51773 not included)

Specifications

- Operating Temp: Approx. 392°F/200°C
- Ramp Up Time: 3-4 minutes
- Recommended Glue Stick: 1/2"
- Glue Melt Rate: up to 1.9 lbs. per hour
- Ave. Run Time: Approx. 140 minutes (full tank)
- Fuel Capacity: 20 ml.
- Dimensions: 8.4" L x 2.1" W x 8.0" H
- Tool Net Weight: 14.8 oz. w/o fuel
- Shipping Weight Tool: 2 lbs.
- Shipping Weight Kit: 3 lbs.
- Shipped Empty



35408 Standard General Purpose Tip
Dia. 4.47mm O.D.



35409 Needle Extension Tip
7.8mm long
Dia. 3.2mm O.D.



35410 Diagonal Cut Extension Tip
8.4mm long x 45°
Dia. 4.74mm O.D.



35411 Spreader Extension Tip
7.6mm(L) x 6.6mm(W)
0.50mm I.D. slot

NOTE: Users should independently evaluate the suitability of the product for their application.

MicroPro® AC MP-100 standby Soldering Iron

Personal electric soldering iron

- Compact, lightweight, easy-to-use
- Fingertip grip, just two inches from target, is ideal for precise work
- Standby temperature mode reduces tip temperature during pauses between soldering jobs for faster warm-up to full solder temperatures
- Standby mode significantly extends tip life, (standby temp: 290°F/140°C, soldering temp: 1004°F (540°C))
- Heating element is located in the solder tip for outstanding heat transfer, heat up and recovery times - 14 watts maximum power
- Green/red LED indicators for standby and operating modes
- Perfect for use with today's lead-free solder
- Perfect personal soldering tool for R&D, electronic engineers and repair technicians



NOTE: Users should independently evaluate the suitability of the product for their application.

MODEL NO.	DESCRIPTION
MP-100	Micropro AC electric standby soldering iron

Optional Accessories

PART NO.	DESCRIPTION	PART NO.	DESCRIPTION
35430	.25mm conical tip	35436	Hot knife tip
35431	.50mm conical tip (std.)	35438	AC/DC power adapter
35432	1.6mm chisel tip	35439	Adapter cord
35433	2.4mm chisel tip	35440	Protective cap
35434	1.0mm bevel tip	35441	Stand/tip removal tool
35435	2.0mm bevel tip		

Specifications

■ Approx. Tip Life: 30,000 cycles (joints) ■ Heater Type: iron-plated anti-corrosion ■ Solder tool dimensions: (with tip) 6.5" L x .52" W (165mm L x 13.20mm W), ■ Adapter dimensions: 3" x 1.9" x .1.3" (75mm L x 48mm W x 35mm D) ■ Tool Weight: 1.1 oz. (30 grams) ■ Adapter Weight: 2.7 oz. (76.5 grams) ■ Shipping Weight: 1 lb. (454 grams)

MicroPro® BT-30 Battery Powered Soldering Iron

Lightweight, compact, completely portable soldering iron

- Standard tool includes 2 Ultratip® soldering tips (1-.5mm conical tip and 1-1.5mm chisel tip), tip removal wrench, and 3 AA Alkaline batteries
- Lightweight and completely portable, equivalent to a 6W electric iron
- Solders approximately 60 minutes continuous duty
- Solders up to 160 joints intermittently with new batteries
- Fast start-up, reaches 361°F (183°C) in 10 seconds
- Total of 8 tips available (2 standard)
- Top quality, plug-in solder tips incorporate built-in heater (patent pending)
- Use to solder and desolder micro sized to small sized parts, perfect for field service and repair work



MODEL NO.	DESCRIPTION
BT-30	Micropro battery-powered, portable soldering iron

Optional Accessories

PART NO.	DESCRIPTION	PART NO.	DESCRIPTION
35364	.5mm conical tip (std.)	35366	1.0mm chisel tip
35367	1mm conical tip	35372	1.5 chisel tip (std.)
35370	1.5mm conical tip	35373	Tip remover
35365	.8mm spade tip	35374	Protective cap
35368	1.3mm spade tip	35375	1.5V AA Alkaline batteries, package of 4
35371	1.8mm spade tip		

Specifications

■ Approx. Solder Tip Temp.: 6W (max) 932°F (500°C) ■ Max. Solder Tip Temp.: 1040°F (560°C) ■ Approx. Tip Life: 30,000 cycles (joints) ■ Time to Reach Operating Temp.: 361°F in 10 Sec. (183°C in 10 Sec.) ■ Approx. Temp. Drop When Touching Object: 212°F (100°C) ■ Heater Type: Built-in, plug-in mounting, iron-plated anti-corrosion ■ Approx. Run Time: 60 Min. Continuous w/New Batteries ■ Approx. No. of Solder Joints, Intermittently: 160 using New Batteries ■ Batteries: 3-1.5V Alkaline, AA ■ Dimensions: 6.8" L x 1.4" W x .8" D (173mm L x 35.5mm W x 20mm D) ■ Net Weight: 3.8 oz. w/Batteries (105 grams w/Batteries) ■ Shipping Weight: 1 lb.

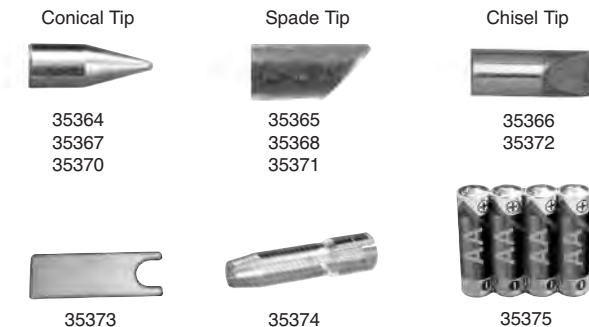

NOTE: Users should independently evaluate the suitability of the product for their application.

Sealed Electrical Systems

Environmentally sealed connections create permanent repairs

- Heavy Duty Trucking
- Marine & RV
- Plant Maintenance Departments
- OEM & Automotive Aftermarket
- Heavy Duty Equipment
- Oil Fields & Mining
- Municipalities & Military Bases

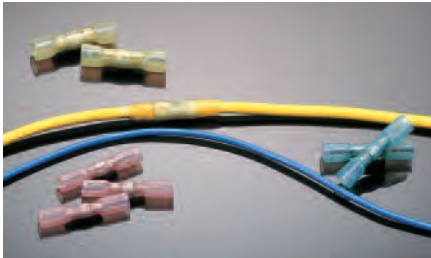

The past decade has seen the advent of sweeping technological advances in the automotive, fleet, and marine industries. Many of these advances involve improved electrical systems, controlled by miniature onboard computers. Consequently, small variations in voltage can significantly affect vehicle performance.

To combat these problems and increase longevity, the major manufacturers in these industries are using completely sealed electrical systems.

Unfortunately, the repair and maintenance industry is lagging behind. The integrity of sealed electrical harnesses is often breached when repairs are made with inferior, unsealed electrical connectors. Master Appliance has the solution.

The heat shrink connector is the innovative solution that allows the aftermarket to keep pace with changing technology. Each repair made with a heat shrink connector is individually protected from corrosion, contaminants and current leakage. This ensures that the original integrity of the wiring harness is maintained.

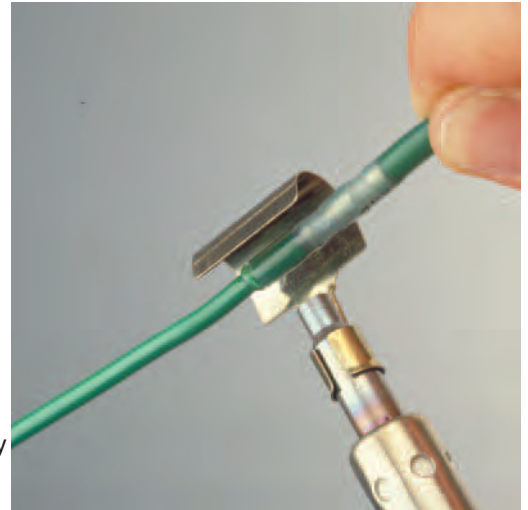

Sealed Electrical Systems

Seal Your Connectors!
Make Permanent Repairs!

Resist water & condensation
Resist salt & other contaminants
Resist wire pull out & current leakage

Master Appliance high quality adhesive-lined Heat-Seal Electrical Connectors are available in three styles:

Multiseal™

Crimp, solder & heat-seal connectors

Solderseal™

Solder & heat-seal connectors

Proseal™

Crimp and heat-seal connectors

Multiseal™ Electrical Connector Kits

High quality crimp, solder & heat-seal connectors

- Crimped for mechanical reliability, soldered for strength and conductivity, and heat sealed for superior durability
- Prevents opening of connector barrel for stronger crimp
- Low temperature pre-measured solder with flux for greater tensile strength and superior current flow
- Uniform adhesive flow does not overflow onto terminal to impede contact
- Heat shrink tubing does not reduce in length creating better insulation along with superior wire support and strain relief
- Translucent, adhesive-lined polyolefin shrink tubing – Allows visual inspection, prevents wire corrosion, and provides a water and contaminant resistant seal
- Color-coded tubing with wire gauge imprint – Provides easy identification of the correct part for the job
- Superior integrity of electrical systems – Sealed electrical systems ensure the original integrity of wire connections and wiring harnesses and conforms with OEM standards. **103 lbs tensile strength**



10058



10067



10066

10058 - Multiseal Butt Splice Connector Minipack

Butt Connectors	Description	Kit Qty	Refill Pack	
	AWG		10 pcs	50 pcs
	20-18 Butt Connector, Red	20	11513	11572
	16-14 Butt Connector, Blue	20	11514	11579
	12-10 Butt Connector, Yellow	10	11515	11567

3 items & 50 pieces

10067 Multiseal Connector Kit

	Description	Kit Qty	Refill Pack	
	AWG		10 pcs	50 pcs
Ring Terminals	20-18 #6 Stud, Red	5	11516	11573
	20-18 #10 Stud, Red	5	11525	11576
	16-14 #10 Stud, Blue	5	11518	11568
	16-14 1/4" Stud, Blue	5	11519	11574
	16-14 3/8" Stud, Blue	5	11520	11581
	12-10 #10" Stud, Yellow	5	11521	11569
	12-10 1/4" Stud, Yellow	5	11523	11582
	12-10 3/8" Stud, Yellow	5	11524	11570
	12-10 1/2" Stud, Yellow	5	11522	11575
Spade Terminals	20-18 #10 Stud, Red	5	11517	11580
	16-14 #10 Stud, Blue	5	11526	11583
	12-10 #10 Stud, Yellow	5	11527	11571
Butt Connectors	24-22 Butt Connector, Clear	5	11512	11566
	20-18 Butt Connector, Red	10	11513	11572
	16-14 Butt Connector, Blue	15	11514	11579
	12-10 Butt Connector, Yellow	10	11515	11567
Insulated Couplers	20-18 Female, .250 Tab, Red	5	11528	11577
	20-18 Male, .250 Tab, Red	5	11529	11578
	16-14 Female, .250 Tab, Blue	5	11530	11584
	16-14 Male, .250 Tab, Blue	5	11531	11585

20 items and 120 pieces

10066 - Multiseal Connector Kit with Tool Slot

10068 - Multiseal Connector Kit with UT-100Si & Crimper

	Description	Kit Qty	Refill Pack	
	AWG		10 pcs	50 pcs
Ring Terminals	18-20 #10 Stud, Red	5	11525	11576
	14-16 #10 Stud, Blue	5	11518	11568
	14-16 1/4" Stud, Blue	5	11519	11574
	14-16 3/8" Stud, Blue	5	11520	11581
	10-12 #10 Stud, Yellow	5	11521	11569
	10-12 1/4" Stud, Yellow	5	11523	11582
Butt Connectors	22-23 Butt Connector, Clear	10	11512	11566
	14-16 Butt Connector, Red	10	11513	11572
	10-12 Butt Connector, Blue	10	11514	11579
	10-12 Butt Connector, Yellow	10	11515	11567
Insulated Couplers	18-20 Female, .250 Tab, Red	5	11528	11577
	18-20 Male, .250 Tab, Red	5	11529	11578
	14-16 Female, .250 Tab, Blue	5	11530	11684
	14-16 Male, .250 Tab, Blue	5	11531	11585

14 items and 90 pieces

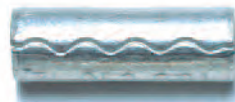

Crimp barrel inside



Solder preform inside

10068



1. Strip wires 3/8" and insert into crimp barrel of the connector

2. Crimp the wires in crimp barrel.

3. Apply heat to the connector until solder and adhesive flows and tubing recovers. Allow the connector to cool.

Crimp

Mechanical reliability holds wires in place

Solder

Ultimate tensile strength • Superior conductivity

Seal

Durable insulation • Watertight connection

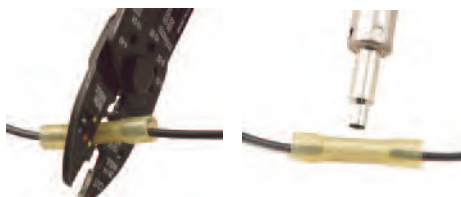

Temperature rating: -67°F to 230°F
 -55°C to 110°C
 Longitudinal change: +1, -10%
 Recovery temperature: 275°F/135°C
 Dielectric strength: 900 Volts/Mil.
 UL Voltage Rating: 600 Volts
 Corrosion resistance: Non-corrosive
 Fungus Resistance: Non-nutrient
 Water absorption: <0.1%

Solderseal™ Electrical Connector Kits

High quality solder & heat-seal connectors

- High quality, sealed solder connection that takes the guess-work out of soldering water tight connections
- Low temperature pre-measured solder with flux for greater tensile strength and superior current flow
- Uniform adhesive flow does not overflow onto terminal to impede contact
- Heat shrink tubing does not reduce in length creating better insulation along with wire superior support and strain relief
- Translucent, adhesive-lined polyolefin shrink tubing – Allows visual inspection, prevents wire corrosion, and provides a water and contaminant resistant seal
- Ensures the original integrity of wire connections and wiring harnesses and conforms with OEM standards **102 lbs tensile strength**



10056



10724



10729

10056 - Solderseal Butt Splice Connector Minipack

Butt Connectors	Description	Kit Qty	Refill Pack	
	AWG		10 pcs	50 pcs
	24-22 Butt Connector, Clear	10	10795	10834
	20-18 Butt Connector, Red	15	10796	10835
	16-14 Butt Connector, Blue	15	10797	10836
	12-10 Butt Connector, Yellow	15	10798	10837

4 items & 55 pieces

10724 - Solderseal Connector Kit

	Description	Kit Qty	Refill Pack	
	AWG		10 pcs	50 pcs
Ring Terminals	20-18 #6 Stud, Red	5	10772	10811
	20-18 #8 Stud, Red	5	10773	10812
	20-18 #10 Stud, Red	5	10774	10813
	20-18 1/4" Stud, Red	5	10775	10814
	16-14 #8 Stud, Blue	5	10779	10818
	16-14 #10 Stud, Blue	5	10780	10819
	16-14 1/4" Stud, Blue	5	10781	10820
	16-14 3/8" Stud, Blue	5	10783	10822
	12-10 #10 Stud, Yellow	5	10784	10823
	12-10 1/4" Stud, Yellow	5	10785	10824
	12-10 3/8" Stud, Yellow	5	10787	10826
	12-10 1/2" Stud, Yellow	5	10788	10827
Spade Terminals	20-18 #10 Stud, Red	5	10792	10831
	16-14 #10 Stud, Blue	5	10793	10832
	12-10 #10 Stud, Yellow	5	10794	10833
Butt Connectors	24-22 Butt Connector, Clear	5	10795	10834
	20-18 Butt Connector, Red	10	10796	10835
	16-14 Butt Connector, Blue	10	10797	10836
	12-10 Butt Connector, Yellow	5	10798	10837
	Insulated Couplers	20-18 Female .250 Tab, Red	5	10799
20-18 Male .250 Tab, Red		5	10801	10840
16-14 Female .250 Tab, Blue		5	10802	10841
16-14 Male .250 Tab, Blue		5	10804	10843
12-10 Female .250 Tab, Yellow		5	10805	10844
12-10 Male .250 Tab, Yellow		5	10807	10846

25 items and 135 pieces

10729 - Solderseal Connector Kit with Tool Slot

10725 - Solderseal Connector Kit with UT-100S

	Description	Kit Qty	Refill Pack	
	AWG		10 pcs	50 pcs
Ring Terminals	20-18 #10 Stud, Red	5	10774	10813
	16-14 #10 Stud, Blue	5	10780	10819
	16-14 1/4" Stud, Blue	5	10781	10820
	16-14 3/8", Stud, Blue	5	10783	10822
	12-10 #10 Stud, Yellow	5	10784	10823
	12-10 3/8" Stud, Yellow	5	10787	10826
	Butt Connectors	24-22 Butt Connector, Yellow	10	10795
20-18 Butt Connector, Red		10	10796	10835
16-14 Butt Connector, Blue		10	10797	10836
12-10 Butt Connector, Yellow		10	10798	10837
Insulated Couplers		16-14 Female, .250 Tab, Blue	5	10802
	16-14 Male, .250 Tab, Blue	5	10804	10843

12 items and 80 pieces



10725

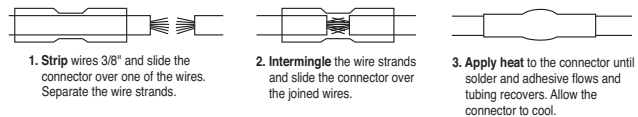

Solder

Ultimate tensile strength • Superior conductivity

Seal

Durable insulation • Watertight connection

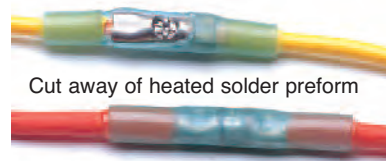

Cut away of heated solder preform

Temperature rating:	-67°F to 230°F -55°C to 110°C
Longitudinal change:	+1, -10%
Recovery temperature:	275°F/135°C
Dielectric strength:	500 Volts/Mil.
UL Voltage Rating:	600 Volts
Corrosion resistance:	Non-corrosive
Fungus Resistance:	Non-nutrient
Water absorption:	<0.1%

Proseal™ Electrical Connector Kits

High quality crimp & heat-seal connectors

- The finest “Crimp & Heat-Seal” connector on the market today. Better wire contact - Less voltage drop - Better current flow
- Seamless butt connectors & brazed seam rings and spades – Prevents opening of connector barrel for stronger crimp
- Uniform adhesive flow does not overflow onto terminal to impede contact
- Heat shrink tubing does not reduce in length, creating better insulation along with superior wire support and strain relief
- Translucent, adhesive-lined polyolefin shrink tubing – Allows visual inspection, prevents wire corrosion and provides a water and contaminant resistant seal
- Color-coded tubing with wire gauge imprint – Provides easy identification of the correct part for the job
- Superior integrity of electrical systems – Sealed electrical systems ensure the original integrity of wire connections and wiring harnesses and conforms with OEM standards. **89 lbs tensile strength**



10054



10600



10723

10054 - Proseal Butt Splice Connector Minipack

Butt Connectors	Description AWG	Kit Qty	Refill Pack	
			10 pcs	50 pcs
	20-18 Butt Connector, Red	20	10932	10666
	16-14 Butt Connector, Blue	20	10934	10667
	12-10 Butt Connector, Yellow	5	10936	10668

3 items & 45 pieces

10600 Assortment Proseal Connector Kit

	Description AWG	Kit Qty	Refill Pack	
			10 pcs	50 pcs
Ring Terminals	20-18 #6 Stud, Red	5	10906	10658
	20-18 #10 Stud, Red	5	10908	10659
	16-14 #8 Stud, Blue	5	10910	10648
	16-14 #10 Stud, Blue	5	10912	10649
	16-14 1/4" Stud, Blue	5	10914	10650
	16-14 3/8" Stud, Blue	5	10916	10652
	12-10 #8 Stud, Yellow	5	10918	10653
	12-10 #10 Stud, Yellow	5	10920	10654
	12-10 1/4" Stud, Yellow	5	10922	10655
Spade Terminals	20-18 #10 Stud, Red	5	10926	10665
	16-14 #10 Stud, Blue	5	10928	10663
	12-10 #10 Stud, Yellow	5	10930	10664
Butt Connectors	20-18 Butt Connector, Red	10	10932	10666
	16-14 Butt Connector, Blue	10	10934	10667
	12-10 Butt Connector, Yellow	10	10936	10668
Insulated Couplers	20-18 Female, .250 Tab, Red	5	10940	10669
	20-18 Male, .250 Tab, Red	5	10938	10672
	16-14 Female, .250 Tab, Blue	5	10944	10671
	16-14 Male, .250 Tab, Blue	5	10942	10673

20 items and 115 pieces

10723 - Proseal Connector Kit with Tool Slot

10719 - Proseal Connector Kit with UT-100Si & Crimper

	Description AWG	Kit Qty	Refill Pack		
			10 pcs	50 pcs	
Ring Terminals	20-18 #10 Stud, Red	5	10908	10859	
	16-14 #8 Stud, Blue	5	10910	10648	
	16-14 #10 Stud, Blue	5	10912	10649	
	16-14 1/4" Stud, Blue	5	10914	10650	
	16-14 3/8" Stud, Blue	5	10916	10652	
	12-10 #10 Stud, Yellow	5	10920	10654	
	12-10 3/8" Stud, Yellow	5	10924	10657	
	Butt Connectors	20-18 Butt Connector, Red	10	10932	10666
		16-14 Butt Connector, Blue	10	10934	10667
12-10 Butt Connector, Yellow		10	10936	10668	
Insulated Couplers	16-14 Female, .250 Tab, Blue	5	10944	10671	
	16-14 Male, .250 Tab, Blue	5	10942	10673	

12 items and 75 pieces

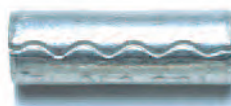

Crimp barrel inside



10719

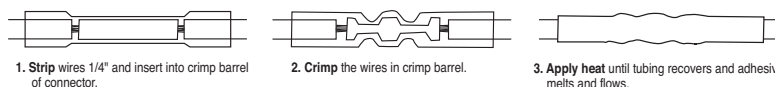

Crimp

Mechanical reliability • Holds wires in place

Seal

Durable insulation • Watertight connection

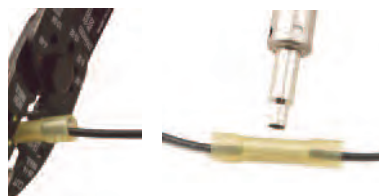

Temperature rating:	-67°F to 230°F -55°C to 110°C
Longitudinal change:	+1, -10%
Recovery temperature:	275°F/135°C
Dialectic strength:	900 Volts/Mil.
UL Voltage Rating:	600 Volts
Water absorption:	<0.1%
Corrosion resistance:	Non-corrosive
Fungus Resistance:	Non-nutrient
Water absorption:	<0.1%

Heat-Shrink Tubing Kits

High quality heat-shrink tubing

Dual wall flexible heat-shrink tubing with adhesive lining

- Polyolefin, 3 to 1 shrink ratio
- Highly flexible for conforming to irregular shapes
- Self-extinguishing UL224 (except clear)
- Internal layer of thermo-plastic adhesive provides a barrier against contaminants



10063

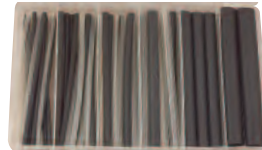

10065



10064

10063 Flexible Adhesive-Lined Shrink Tubing Minipack

Flexible Shrink Tubing	Description	Kit Qty	Refill 8 pcs
	1/8" pre-shrink I.D., 6" length, Black	5	11620
	1/4" pre-shrink I.D., 6" length, Black	5	11626
	3/8" pre-shrink I.D., 6" length, Black	5	11629
	1/2" pre-shrink I.D., 6" length, Black	4	11632
	3/4" pre-shrink I.D., 6" length, Black	3	11635
	1" pre-shrink I.D., 6" length, Black	2	11638

6 items and 24 pieces

10064 Flexible Adhesive-Lined Shrink Tubing Kit

Flexible Shrink Tubing	Description	Kit Qty	Refill 8 pcs
	1/8" pre-shrink I.D., 6" length, Black	5	11620
	1/8" pre-shrink I.D., 6" length, Clear	3	11621
	1/8" pre-shrink I.D., 6" length, Red	3	11622
	3/16" pre-shrink I.D., 6" length, Black	5	11623
	3/16" pre-shrink I.D., 6" length, Clear	2	11624
	3/16" pre-shrink I.D., 6" length, Red	2	11625
	1/4" pre-shrink I.D., 6" length, Black	5	11626
	1/4" pre-shrink I.D., 6" length, Clear	2	11627
	1/4" pre-shrink I.D., 6" length, Red	2	11628
	3/8" pre-shrink I.D., 6" length, Black	5	11629
	3/8" pre-shrink I.D., 6" length, Clear	2	11630
	3/8" pre-shrink I.D., 6" length, Red	2	11631
	1/2" pre-shrink I.D., 6" length, Black	3	11632
	1/2" pre-shrink I.D., 6" length, Clear	2	11633
	1/2" pre-shrink I.D., 6" length, Red	2	11634
	3/4" pre-shrink I.D., 6" length, Black	1	11635
	3/4" pre-shrink I.D., 6" length, Clear	1	11636
	3/4" pre-shrink I.D., 6" length, Red	1	11637



18 items and 48 pieces

10065 Flexible Adhesive-Lined Shrink Tubing Kit

Flexible Shrink Tubing	Description	Kit Qty	Refill 8 pcs
	1/8" pre-shrink I.D., 6" length, Black	10	11620
	1/8" pre-shrink I.D., 6" length, Clear	10	11621
	3/16" pre-shrink I.D., 6" length, Black	8	11623
	3/16" pre-shrink I.D., 6" length, Clear	8	11624
	1/4" pre-shrink I.D., 6" length, Black	6	11626
	1/4" pre-shrink I.D., 6" length, Clear	6	11627
	3/8" pre-shrink I.D., 6" length, Black	4	11629
	3/8" pre-shrink I.D., 6" length, Clear	4	11630
	1/2" pre-shrink I.D., 6" length, Black	3	11632
	1/2" pre-shrink I.D., 6" length, Clear	3	11633
	3/4" pre-shrink I.D., 6" length, Black	2	11635
	3/4" pre-shrink I.D., 6" length, Clear	2	11636

12 items and 66 pieces

MIL-DTL-23053/4 Class 3
UL E157227
Recovery temp. 250°F/121°C,
Dielectric strength 700V/Mil.,
Continuous oper. temp. -67°F to 230°F/-55°C to 110°C

Thin wall flexible heat-shrink tubing with no adhesive

- Polyolefin, 2 to 1 shrink ratio
- Highly flexible for conforming to irregular shapes
- Self-extinguishing UL224 (except clear)



10061



10062

10061 Thin Wall Flexible Shrink Tubing Minipack

Flexible Shrink Tubing	Description	Kit Qty	Refill 10 pcs
	3/16" pre-shrink I.D., 6" length, Black	5	11601
	3/16" pre-shrink I.D., 6" length, Red	5	11602
	1/4" pre-shrink I.D., 6" length, Black	5	11603
	1/4" pre-shrink I.D., 6" length, Blue	5	11604
	3/8" pre-shrink I.D., 6" length, Black	5	11605
	3/8" pre-shrink I.D., 6" length, Yellow	5	11606
	1/2" pre-shrink I.D., 6" length, Black	4	11607
	3/4" pre-shrink I.D., 6" length, Black	3	11608
	1" pre-shrink I.D., 6" length, Black	2	11609

9 items and 39 pieces

10062 Thin Wall Flexible Shrink Tubing Kit

Flexible Shrink Tubing	Description	Kit Qty	Refill 10 pcs
	3/16" pre-shrink I.D., 6" length, Black	20	11601
	3/16" pre-shrink I.D., 6" length, Red	15	11602
	1/4" pre-shrink I.D., 6" length, Black	20	11603
	1/4" pre-shrink I.D., 6" length, Blue	10	11604
	3/8" pre-shrink I.D., 6" length, Black	10	11605
	3/8" pre-shrink I.D., 6" length, Yellow	10	11606
	1/2" pre-shrink I.D., 6" length, Black	10	11607
	3/4" pre-shrink I.D., 6" length, Black	5	11608
	1" pre-shrink I.D., 6" length, Black	3	11609

9 items and 103 pieces

MIL-DTL-23053/5 Class 1 (colors) Class 2 (clear),
UL E35506 (except clear), CSA LR31929 (except clear),
Recovery temperature: 250°F/121°C, Dielectric strength: 900 Volts/Mil.,
Continuous operating temperature: -67°F to 275°F/-55°C to 135°C

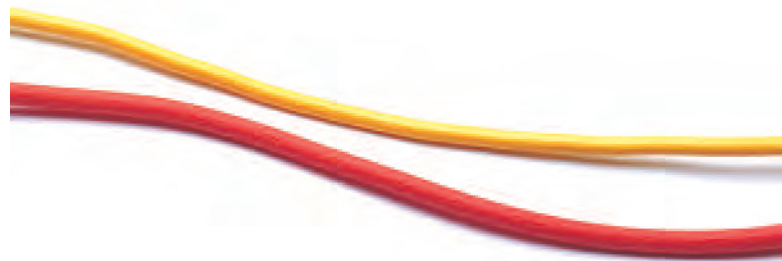

Electrical Connector Kit Refills

Multiseal™, Solderseal™ & Proseal™ heat-seal electrical connectors

Part Number	Description	Std.Pack
Multiseal Ring Terminals		
11516	18-20 AWG, Red, #6 Stud	10
11573	18-20 AWG, Red, #6 Stud	50
11525	18-20 AWG, Red, #10 Stud	10
11576	18-20 AWG, Red, #10 Stud	50
11518	14-16 AWG, Blue, #10 Stud	10
11568	14-16 AWG, Blue, #10 Stud	50
11519	14-16 AWG, Blue, 1/4" Stud	10
11574	14-16 AWG, Blue, 1/4" Stud	50
11520	14-16 AWG, Blue, 3/8" Stud	10
11581	14-16 AWG, Blue, 3/8" Stud	50
11521	10-12 AWG, Yellow, #10 Stud	10
11569	10-12 AWG, Yellow, #10 Stud	50
11523	10-12 AWG, Yellow, 1/4" Stud	10
11582	10-12 AWG, Yellow, 1/4" Stud	50
11524	10-12 AWG, Yellow, 3/8" Stud	10
11570	10-12 AWG, Yellow, 3/8" Stud	50
11522	10-12 AWG, Yellow, 1/2" Stud	10
11575	10-12 AWG, Yellow, 1/2" Stud	50
Multiseal Spade Terminals		
11517	18-20 AWG, Red, #10 Stud	10
11580	18-20 AWG, Red, #10 Stud	50
11526	14-16 AWG, Blue, #10 Stud	10
11583	14-16 AWG, Blue, #10 Stud	50
11527	10-12 AWG, Yellow, #10 Stud	10
11571	10-12 AWG, Yellow, #10 Stud	50
Multiseal Butt Connectors		
11512	22-24 AWG, Clear Butt	10
11566	22-24 AWG, Clear Butt	50
11513	18-20 AWG, Red Butt	10
11572	18-20 AWG, Red Butt	50
11514	14-16 AWG, Blue Butt	10
11579	14-16 AWG, Blue Butt	50
11515	10-12 AWG, Yellow Butt	10
11567	10-12 AWG, Yellow Butt	50
Multiseal Female Slip-On Terminals		
11528	18-20 AWG, Red	10
11577	18-20 AWG, Red	50
11530	14-16 AWG, Blue	10
11584	14-16 AWG, Blue	50
Multiseal Male Slip-On Terminals		
11529	18-20 AWG, Red	10
11578	18-20 AWG, Red	50
11531	14-16 AWG, Blue	10
11585	14-16 AWG, Blue	50
Solderseal Ring Terminals		
10772	18-20 AWG, Red, # 6 Stud	10
10811	18-20 AWG, Red, # 6 Stud	50
10773	18-20 AWG, Red, # 8 Stud	10
10812	18-20 AWG, Red, # 8 Stud	50
10774	18-20 AWG, Red, # 10 Stud	10
10813	18-20 AWG, Red, # 10 Stud	50
10775	18-20 AWG, Red, 1/4" Stud	10
10814	18-20 AWG, Red, 1/4" Stud	50
10779	14-16 AWG, Blue, # 8 Stud	10
10818	14-16 AWG, Blue, # 8 Stud	50
10780	14-16 AWG, Blue, # 10 Stud	10
10819	14-16 AWG, Blue, # 10 Stud	50
10781	14-16 AWG, Blue, 1/4" Stud	10
10820	14-16 AWG, Blue, 1/4" Stud	50
10783	14-16 AWG, Blue, 3/8" Stud	10
10822	14-16 AWG, Blue, 3/8" Stud	50
10784	10-12 AWG, Yellow, # 10 Stud	10
10823	10-12 AWG, Yellow, # 10 Stud	50
10785	10-12 AWG, Yellow, 1/4" Stud	10
10824	10-12 AWG, Yellow, 1/4" Stud	50
10787	10-12 AWG, Yellow, 3/8" Stud	10
10826	10-12 AWG, Yellow, 3/8" Stud	50
10788	10-12 AWG, Yellow, 1/2" Stud	10
10827	10-12 AWG, Yellow, 1/2" Stud	50
Solderseal Spade Terminals		
10792	18-20 AWG, Red, # 10 Stud	10
10831	18-20 AWG, Red, # 10 Stud	50
10793	14-16 AWG, Blue, # 10 Stud	10
10832	14-16 AWG, Blue, # 10 Stud	50
10794	10-12 AWG, Yellow, # 10 Stud	10
10833	10-12 AWG, Yellow, # 10 Stud	50

Solderseal Butt Connectors		
10795	22-24 AWG, Clear	10
10834	22-24 AWG, Clear	50
10796	18-20 AWG, Red	10
10835	18-20 AWG, Red	50
10797	14-16 AWG, Blue	10
10836	14-16 AWG, Blue	50
10798	10-12 AWG, Yellow	10
10837	10-12 AWG, Yellow	50
Part Number	Description	Std.Pack
Solderseal Slip-On Connectors		
10799	18-20 AWG, Red, .250 Female	10
10838	18-20 AWG, Red, .250 Female	50
10801	18-20 AWG, Red, .250 Male	10
10840	18-20 AWG, Red, .250 Male	50
10802	14-16 AWG, Blue, .250 Female	10
10841	14-16 AWG, Blue, .250 Female	50
10804	14-16 AWG, Blue, .250 Male	10
10843	14-16 AWG, Blue, .250 Male	50
10805	10-12 AWG, Yellow, .250 Female	10
10844	10-12 AWG, Yellow, .250 Female	50
10807	10-12 AWG, Yellow, .250 Male	10
10846	10-12 AWG, Yellow, .250 Male	50
Proseal Ring Terminals		
10906	18-20 AWG, Red, # 6 Stud	10
10658	18-20 AWG, Red, # 6 Stud	50
10908	18-20 AWG, Red, # 10 Stud	10
10659	18-20 AWG, Red, # 10 Stud	50
10910	14-16 AWG, Blue, # 8 Stud	10
10648	14-16 AWG, Blue, # 8 Stud	50
10912	14-16 AWG, Blue, # 10 Stud	10
10649	14-16 AWG, Blue, # 10 Stud	50
10914	14-16 AWG, Blue, 1/4" Stud	10
10650	14-16 AWG, Blue, 1/4" Stud	50
10916	14-16 AWG, Blue, 3/8" Stud	10
10652	14-16 AWG, Blue, 3/8" Stud	50
10918	10-12 AWG, Yellow, # 8 Stud	10
10653	10-12 AWG, Yellow, # 8 Stud	50
10920	10-12 AWG, Yellow, # 10 Stud	10
10654	10-12 AWG, Yellow, # 10 Stud	50
10922	10-12 AWG, Yellow, 1/4" Stud	10
10655	10-12 AWG, Yellow, 1/4" Stud	50
10924	10-12 AWG, Yellow, 3/8" Stud	10
10657	10-12 AWG, Yellow, 3/8" Stud	50
Proseal Spade Terminals		
10926	18-20 AWG, Red, # 10 Stud	10
10665	18-20 AWG, Red, # 10 Stud	50
10928	14-16 AWG, Blue, # 10 Stud	10
10663	14-16 AWG, Blue, # 10 Stud	50
10930	10-12 AWG, Yellow, # 10 Stud	10
10664	10-12 AWG, Yellow, # 10 Stud	50
Proseal Butt Connectors		
10932	18-20 AWG, Red	10
10666	18-20 AWG, Red	50
10934	14-16 AWG, Blue	10
10667	14-16 AWG, Blue	50
10936	10-12 AWG, Yellow	10
10668	10-12 AWG, Yellow	50
Proseal Fully Insulated Slip On Connectors		
10940	18-20 AWG, Red, .250 Female	10
10669	18-20 AWG, Red, .250 Female	50
10938	18-20 AWG, Red, .250 Male	10
10672	18-20 AWG, Red, .250 Male	50
10944	14-16 AWG, Blue, .250 Female	10
10671	14-16 AWG, Blue, .250 Female	50
10942	14-16 AWG, Blue, .250 Male	10
10673	14-16 AWG, Blue, .250 Male	50



Multiseal Patent Numbers:
Butt Connectors - US 6,838,621 B2, US 6,677,529 B1
Terminals - US 6,666,732, B1

Solderseal Patent Numbers:
Butt Connectors - US 4,883,925
Ring and spades - US 5,137,478

Heat-Shrink Tubing Kit Refills

Thin and dual wall heat-shrink tubing



Master Heat® Guns or Butane-powered portable heat tools, when used with these flexible polyolefin connectors and shrink tubing, create wireharness repairs that meet OEM Standards.

Thin Wall Shrink Tubing 6" Long (NO ADHESIVE)		
11601	Shrink Tubing, 3/16", Black	10
11602	Shrink Tubing, 3/16", Red	10
11603	Shrink Tubing, 1/4", Black	10
11604	Shrink Tubing, 1/4", Blue	10
11605	Shrink Tubing, 3/8", Black	10
11606	Shrink Tubing, 3/8", Yellow	10
11607	Shrink Tubing, 1/2", Black	10
11608	Shrink Tubing, 3/4", Black	10
11609	Shrink Tubing, 1", Black	10
Dual Wall Shrink Tubing 6" Long (WITH ADHESIVE)		
11620	Shrink Tubing, 1/8", Black	8
11621	Shrink Tubing, 1/8", Clear	8
11622	Shrink Tubing, 1/8", Red	8
11623	Shrink Tubing, 3/16", Black	8
11624	Shrink Tubing, 3/16", Clear	8
11625	Shrink Tubing, 3/16", Red	8
11626	Shrink Tubing, 1/4", Black	8
11627	Shrink Tubing, 1/4", Clear	8
11628	Shrink Tubing, 1/4", Red	8
11629	Shrink Tubing, 3/8", Black	8
11630	Shrink Tubing, 3/8", Clear	8
11631	Shrink Tubing, 3/8", Red	8
11632	Shrink Tubing, 1/2", Black	8
11633	Shrink Tubing, 1/2", Clear	8
11634	Shrink Tubing, 1/2", Red	8
11635	Shrink Tubing, 3/4", Black	8
11636	Shrink Tubing, 3/4", Clear	8
11637	Shrink Tubing, 3/4", Red	8
11638	Shrink Tubing, 1", Black	8
11639	Shrink Tubing, 1", Clear	8
11640	Shrink Tubing, 1", Red	8

Crimping Tools

Hand tools for heat-seal electrical connectors

Cutter, Stripper, Crimper

- Two precision-ground wire cutters: up-front anvil-type and scissors-type located behind pivot point
- Cuts, strips and crimps stranded wire in 22 to 10 AWG sizes and solid wire in 18 to 8 AWG sizes
- Cuts 6-32, 8-32, 10-32, 10-24 and 4-40 bolts and screws
- Scissors action wire stripper is precision-ground for accuracy and clean, neat stripping
- Cushioned handle for user comfort, made of heat-treated tool steel for long life, reliability and accuracy



35083

MODEL NO.	DESCRIPTION
35083	Cutter, Stripper, Crimper

Ratcheting Crimper

- Crimps 22-18, 16-14 and 12-10 AWG size connectors
- Rounded crimp die area for insulated terminals
- Industry standard color-coded crimp numbers for easy size identification
- Full-cycle ratcheting handle ensures a complete crimp
- Made from heat-treated steel for long life and reliability
- Cushioned handle for user comfort

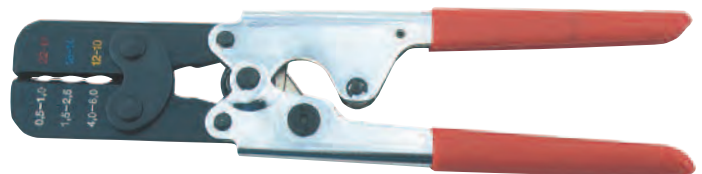

35084

MODEL NO.	DESCRIPTION
35084	Crimp Tool, Ratcheting, Full Cycle

NOTE: Users should independently evaluate the suitability of the product for their application.

Master Heat® Tools Factory Warranty

Every Master Heat Tool comes with a one year limited warranty

One Year Warranty

Master Heat Tools are carefully tested and inspected before being shipped from the factory. We warrant our products to be free from defects in materials and workmanship, under normal use and service, for one year from the date of purchase. In the event of a defect in materials or workmanship we will either repair or replace, at our option, without charge any part which in our judgement shows evidence of such defect.

Warranty does not apply to wearable items such as attachments, brushes, heating elements, soldering tips, hot air tips, burners or ejectors, which require periodic replacement, nor does it apply if the heat tool has been misused, abused, tampered with or altered.

At the end of the warranty period, Master Appliance shall be under no further obligation, expressed or implied. Master Appliance assumes no responsibility for, and this warranty shall not cover, any incidental or consequential damages from any defect in products or their use.

This warranty gives you specific rights. You may also have other rights which may vary from state to state. Warranty information is included within the Instruction Manual for each product or may be obtained by contacting Master's Customer Service Department at 800-558-9413, 262-633-7791 or www.masterappliance.com.

Master heat tools are sold worldwide through a network of Authorized Stocking Distributors. Trained Sales and Customer Service Representatives, located at our headquarters and throughout the world, insure fast personal service.

Contact us for your nearest stocking distributor or sales representative.

Visit our website for up-to-date information on products, accessories, parts, warranty and repair service.

Master Heat® Tool Applications

Professional quality heat tools for Industry

Master Heat Tools

Heat has many industrial applications. The proper use of the right heat technology and the right product are necessary to achieve optimum results in each application.

Master is continually developing new products and techniques to meet the demands of new applications. Master heat guns are designed and constructed to provide our customers with dependable, cost-effective ways to apply heat properly for specific jobs.

As a leader with over fifty years of experience in the industry, the Master Appliance name assures its customers of an uncommon expertise in heat technology, quality products and unsurpassed service.

Our original heat gun met the heating needs of the maintenance, repair, operation and production applications of its time. Today's Master heat tools are designed with expanded capabilities which make it easy to work with the growing range of new materials and processes being developed by industry.

Master heat tools are used for drying, heating, welding, shrinking, soldering and de-soldering as well as a variety of other applications. Wherever heat is the need, Master has the answer.

Because each application is unique, the Master heat tool line offers options such as varying temperatures and air flow, a choice of nozzle configurations, attachments and voltage/plug combinations to meet your needs.

The introduction of new plastics, adhesives and other materials is a continuous process. The range of options and attachments offered by Master heat tools enables you to use the newest materials and techniques while relying on the traditional Master quality and durability.

Master is always here to help. When you're considering a new application, material or process, call Master Appliance for professional, efficient and courteous assistance.

Applications/Processes

Master heat tools are being used for hundreds of applications and processes throughout industry including:

- Activate adhesives and potting compounds
- Bend and form plastics and plastic laminates
- Cure and set adhesives
- Defrost freezers and frozen coils
- Dry body filler
- Dry conformal coatings on circuit boards
- Dry parts
- Expand metals
- General heating and drying applications
- Desolder backs of printed circuit boards to thru-hole components
- PVC bending
- Preheat flux
- Remove dents in fiberglass and other materials
- Remove pin striping
- Remove/install plastic autobody panels
- Remove windshield caulking
- Shrink and terminate environmental splices
- Shrink and terminate heat-shrinkable insulated solder preforms
- Shrink heat-shrinkable anti-static film
- Shrink heat-shrinkable molded parts
- Shrink heavy gauge shrink packaging
- Shrink heavy wall and adhesive-lined tubings
- Smooth vinyl tops
- Solder and desolder
- Spot dry paint
- Stretch vinyls
- Strip paint
- Vinyl repair

New applications and processes which require heat are discovered everyday. Users should independently evaluate the suitability of the product for their application.

As with all electrical and butane-powered tools, for your safety, read the instruction manual before using.

Product specifications are subject to change without notice.

MASTER[®]

A P P L I A N C E

Designers and Manufacturers of Heat Tools for Industry

Worldwide Corporate Headquarters

Master Appliance Corp.

2420 -18th Street, Racine, WI 53403-2300 U.S.A.

Sales/Customer Service: 800-558-9413 (US & Canada)

Local and International: 262-633-7791

Fax: 262-633-9745

sales@masterappliance.com

www.masterappliance.com

For Master Appliance products contact:

