

# Piezoelectric Ceramic Sensors (PIEZOTITE®)



## Shock Sensors

The shock sensor, PKGS series, is acceleration sensor with 2 terminals and detects acceleration & shock to be applied from outside, as electrical signal.

By bimorph piezo elements clamped at the two-end with original polarization technology, the shock sensor has high sensitivity and excellent durability.

The shock sensor is reflow solderable SMD type.

The shock sensor can have inclined primary axis so that appropriate shock sensor can be chosen for shock detection in HDD (Hard Disk Drive) and optical pick-up control in optical drive & optical-magnetic Drive.



### ■ Features

1. Small size, low profile, high sensitivity and excellent durability.
2. Excellent linearity.
3. High resonance frequency and wide bandwidth.
4. Available tape and reel packaging.
5. Reflowable.
6. In addition to the voltage sensitivity type shock sensor (ME, LB and LC series), new type, the electrical charge sensitivity type shock sensor (NB, MF and LD series) are released. NB, MF and LD series have better anti-reflow temperature.

### ■ Applications

1. HDD data writing protection, while shock is applied from outside.
2. Shock detection and protection in DVD, CD-R, CD-RW etc.
3. Pick-up control for disk type storage in Digital camera, Camcorder etc.
4. Other applications requiring acceleration detection.

### ■ Primary Axis Inclined Angle

The acceleration detection direction with the shock sensor can be inclined relative to the PCB. This inclination is called the primary-axis-inclined angle and can be selected from the four variations that are shown in the diagram on the right-0, 25, 45, and 90 degrees, respectively.

The acceleration detection sensitivity is greatest with the acceleration in the primary axis direction (direction D). With the 25- and 45-degree sensor types,

the detection sensitivity is available in both the Y and Z directions.

### ■ Polarity

The shock sensor has polarity. Referring to the diagram on the right, when acceleration is applied in direction D, a positive voltage (relative to the voltage on electrode A) occurs on electrode B.

#### ■ Primary Axis Inclined Angle (0 degree)

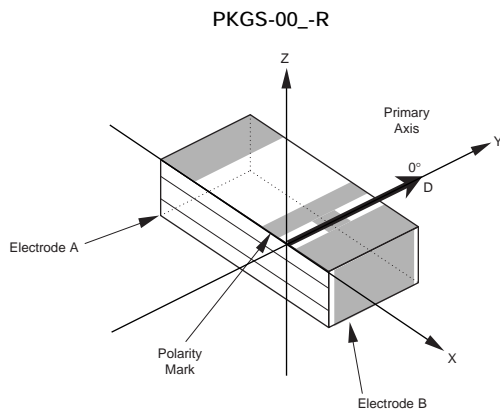

#### ■ Primary Axis Inclined Angle (25 degree)

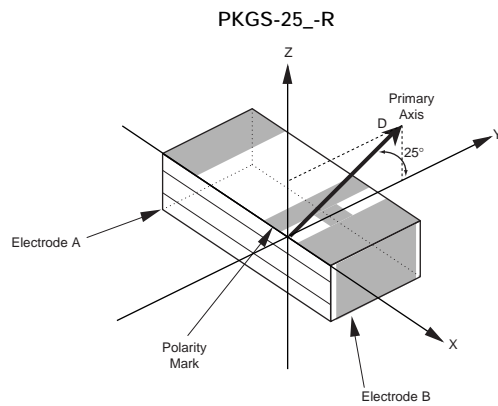

#### ■ Primary Axis Inclined Angle (45 degree)

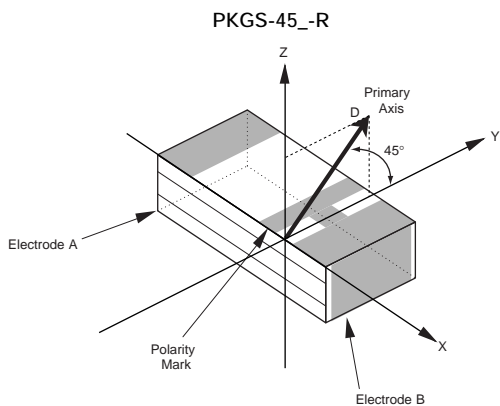

#### ■ Primary Axis Inclined Angle (90 degree)

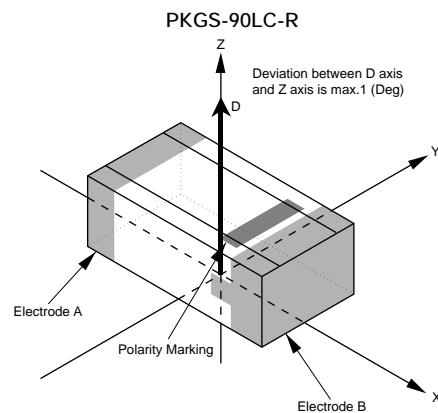

Under bar shown in part number is filled with two letters of Characteristics codes.

5

## Charge Sensitivity Type PKGS-\_NB-R



PKGS-\_NB-R

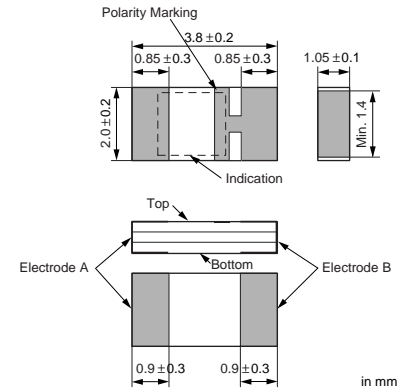

Part Number	Primary Axis Inclined Angle (°)	Sensitivity* (pC/G)	Capacitance (pF)	Insulation Resistance (M ohm)	Resonant Frequency (kHz)	Non-linearity (%)
PKGS-00NB-R	0	0.153 typ.	480 typ.	500 min.	44 typ.	1 typ.
PKGS-25NB-R	25	0.168 typ.	520 typ.	500 min.	44 typ.	1 typ.
PKGS-45NB-R	45	0.133 typ.	440 typ.	500 min.	43 typ.	1 typ.

Operatig Temperature Range : -40°C to 85°C      Storage Temperature Range : -40°C to 85°C  
\*1G=9.80665m/s<sup>2</sup>

## Charge Sensitivity Large Type PKGS-\_MF-R Series



PKGS-\_MF-R

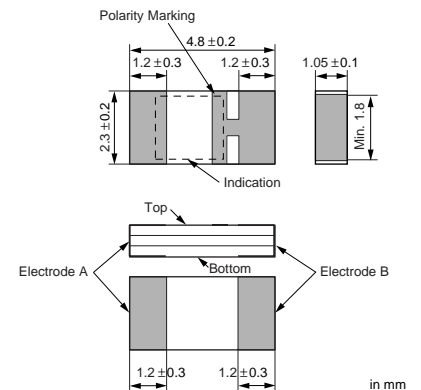

Part Number	Primary Axis Inclined Angle (°)	Sensitivity* (pC/G)	Capacitance (pF)	Insulation Resistance (M ohm)	Resonant Frequency (kHz)	Non-linearity (%)
PKGS-00MF-R	0	0.325 typ.	570 typ.	500 min.	27 typ.	1 typ.
PKGS-25MF-R	25	0.350 typ.	610 typ.	500 min.	27 typ.	1 typ.
PKGS-45MF-R	45	0.285 typ.	490 typ.	500 min.	26 typ.	1 typ.

Operatig Temperature Range : -40°C to 85°C      Storage Temperature Range : -40°C to 85°C  
\*1G=9.80665m/s<sup>2</sup>

## Charge Sensitivity Type PKGS-LD-R Series



PKGS-LD-R

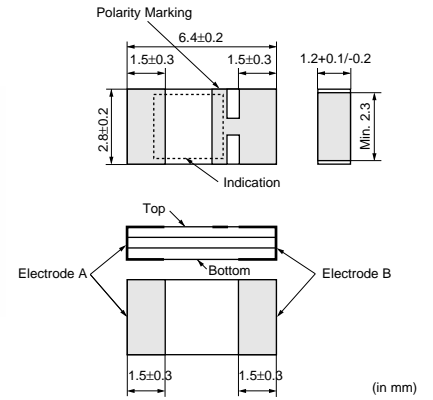

Part Number	Primary Axis Inclined Angle (°)	Sensitivity* (pC/G)	Capacitance (pF)	Insulation Resistance (M ohm)	Resonant Frequency (kHz)	Non-linearity (%)
<b>PKGS-00LD-R</b>	0	0.840 typ.	770 typ.	500 min.	20 typ.	1 typ.
<b>PKGS-45LD-R</b>	45	0.790 typ.	690 typ.	500 min.	18 typ.	1 typ.

Operatig Temperature Range : -40°C to 85°C      Storage Temperature Range : -40°C to 85°C  
 \*1G=9.80665m/s<sup>2</sup>

## Voltage sensitivity Type PKGS-ME-R Series

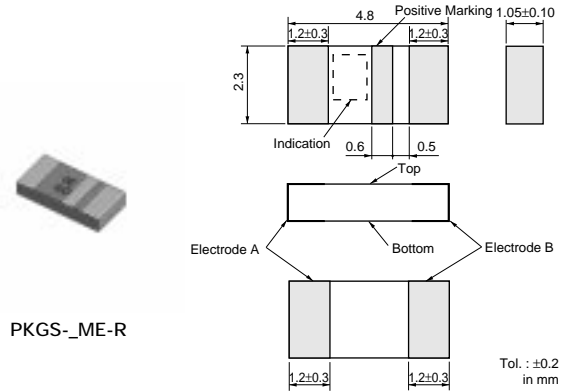

PKGS-ME-R

Part Number	Primary Axis Inclined Angle (°)	Sensitivity* (mV/G)	Capacitance (pF)	Insulation Resistance (M ohm)	Resonant Frequency (kHz)	Non-linearity (%)
PKGS-00ME-R	0	1.00 typ.	160 typ.	500 min.	27 typ.	1 typ.
PKGS-25ME-R	25	1.0 typ.	170 typ.	500 min.	27 typ.	1 typ.
PKGS-45ME-R	45	1.00 typ.	210 typ.	500 min.	27 typ.	1 typ.

Operatig Temperature Range : -40°C to 85°C    Storage Temperature Range : -40°C to 85°C  
\*1G=9.80665m/s<sup>2</sup>

## Voltage sensitivity Type PKGS-LB-R Series

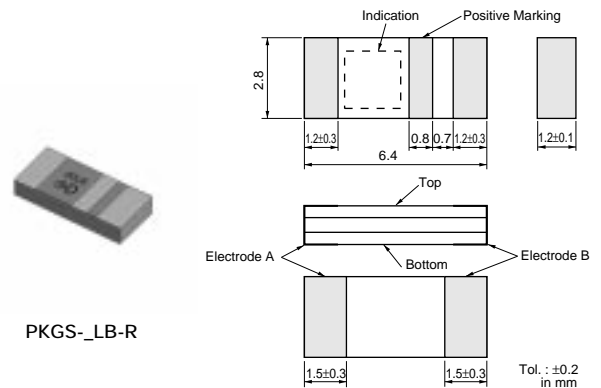

PKGS-LB-R

Part Number	Primary Axis Inclined Angle (°)	Sensitivity* (mV/G)	Capacitance (pF)	Insulation Resistance (M ohm)	Resonant Frequency (kHz)	Non-linearity (%)
PKGS-00LB-R	0	1.85 typ.	210 typ.	500 min.	20 typ.	1 typ.
PKGS-25LB-R	25	1.85 typ.	240 typ.	500 min.	20 typ.	1 typ.
PKGS-45LB-R	45	1.93 typ.	295 typ.	500 min.	20 typ.	1 typ.

Operatig Temperature Range : -40°C to 85°C    Storage Temperature Range : -40°C to 85°C  
\*1G=9.80665m/s<sup>2</sup>

## Voltage sensitivity Type PKGS-LC-R Series



PKGS-00LC-R

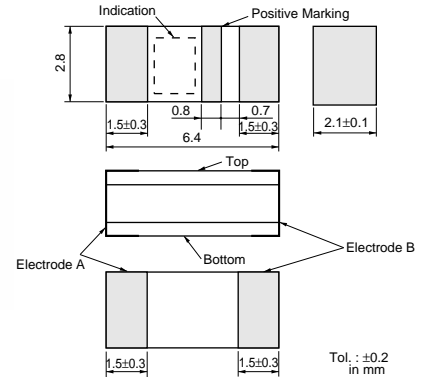

PKGS-90LC-R

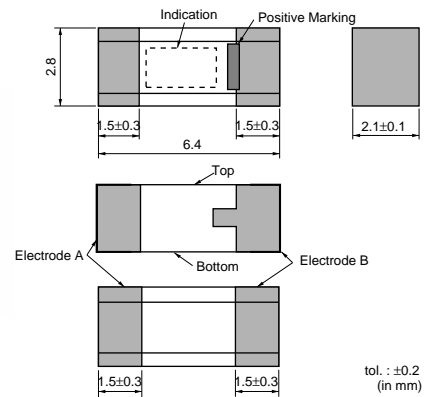

Part Number	Primary Axis Inclined Angle (°)	Sensitivity* (mV/G)	Capacitance (pF)	Insulation Resistance (M ohm)	Resonant Frequency (kHz)	Non-linearity (%)
PKGS-00LC-R	0	2.10 typ.	420 typ.	500 min.	20 typ.	1 typ.
PKGS-90LC-R	90	2.10 typ.	420 typ.	500 min.	20 typ.	1 typ.

Operatig Temperature Range : -40°C to 85°C    Storage Temperature Range : -40°C to 85°C  
 \*1G=9.80665m/s<sup>2</sup>

5

# Reference Data

## ■ Freq. Characteristics (Typical)

PKGS-\_NB-R

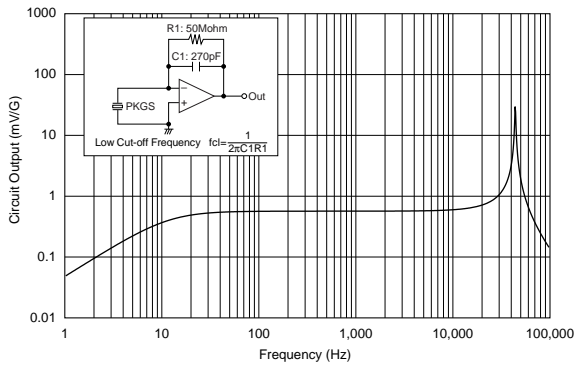

PKGS-\_MF-R

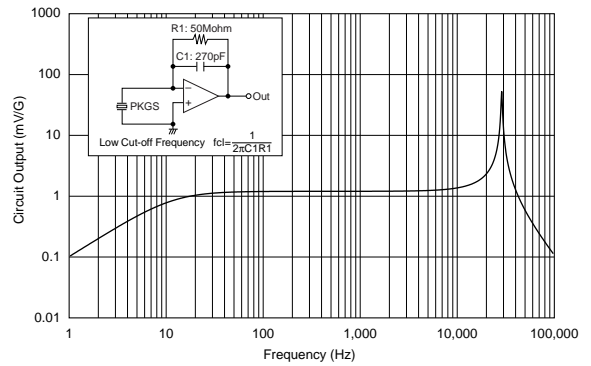

PKGS-\_LD-R

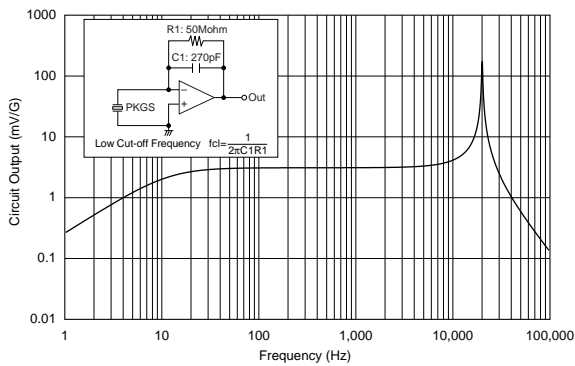

PKGS-\_ME-R

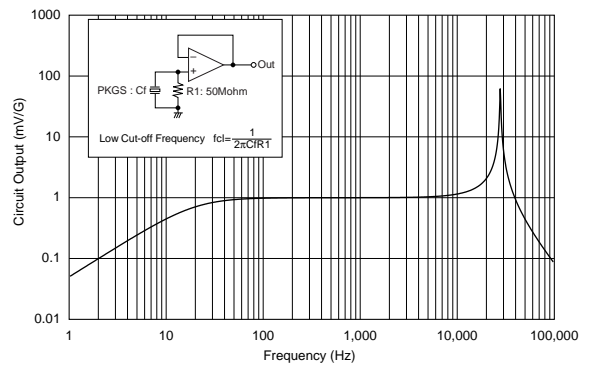

PKGS-\_LB-R

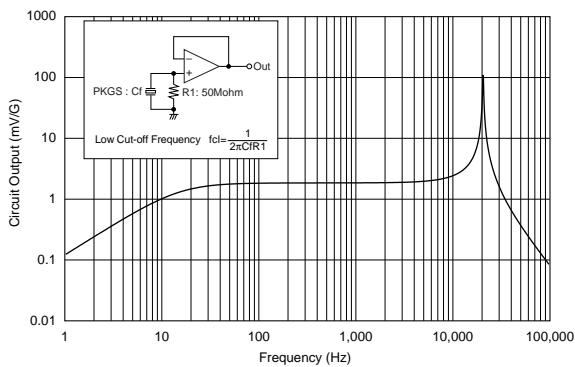

PKGS-\_LC-R

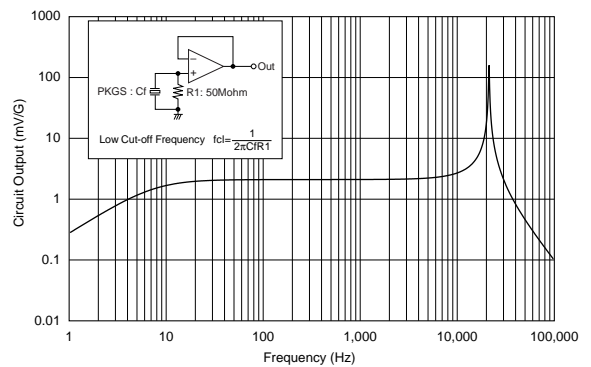

Under bar shown in part number is filled with two figures of inclined angle.

# PKGS Series Mounting/Notice/Part Numbering

## Standard Land Pattern

Standard Land Pattern

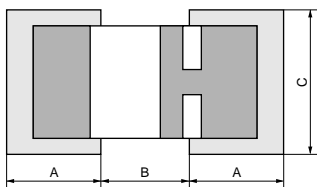

Dimensions

	PKGS-□□NB-R	PKGS-□□MF-R/ME-R	PKGS-□□LD-R/LB-R/LC-R
A	1.4 mm	1.7 mm	2.0 mm
B	2.0 mm	2.4 mm	3.4 mm
C	2.0 mm	2.3 mm	2.8 mm

## Standard Reflow Profile

PKGS-  NB-R/MF-R/LD-R

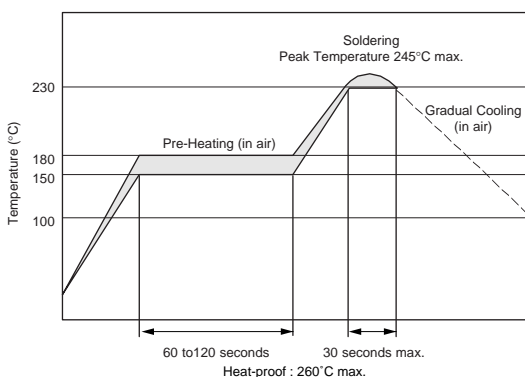

PKGS-  ME-R/LB-R/LC-R

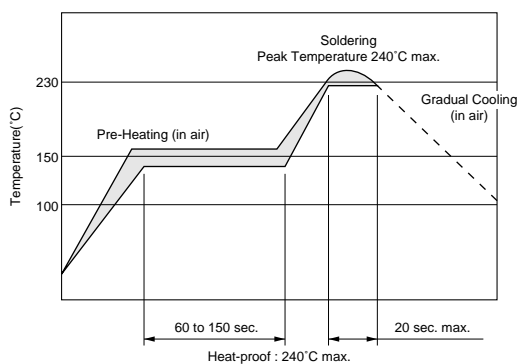

## Notice (Rating)

Please do not apply DC voltage for this shock sensor.

## Notice (Soldering and Mounting)

- Depending on the factors such as the system for securing the PCB or the rigidity of the vibration member, a new resonance system can occur, which adversely affects the accuracy of the acceleration measurement with the shock sensor. Therefore, be very careful to eliminate factors that can affect accuracy.
- Please inquire Murata for washing conditions.

## Part Numbering (The structure of the "Global Part Numbers" that have been adopted since June 2001 and the meaning of each code are described herein.)

If you have any questions about details, inquire at your usual Murata sales office or distributor.

### Shock Sensors

(Global Part Number) **PK** **GS-25** **ME** **1** **-R**

① ② ③ ④ ⑤

- ① Product ID
- ② Series
- ③ Characteristics
- ④ Individual Specification Code
- ⑤ Packaging

\* Global Part Number shows only an example which might be different from actual part number.

\* "③ Characteristics", "④ Individual Specification Code" and "⑤ Packaging" might have different digit number from actual Global Part Number.



## Package

### ■ Minimum Quantity

PKGS-\_NB-R:180mm dir. reel/3000 pcs.  
 PKGS-\_MF-R:180mm dir. reel/3000 pcs.  
 PKGS-\_LD-R:180mm dir. reel/2000 pcs.  
 PKGS-\_ME-R:180mm dir. reel/3000 pcs.  
 PKGS-\_LB-R:180mm dir. reel/2000 pcs.  
 PKGS-\_LC-R:180mm dir. reel/1500 pcs.

### ■ Dimensions of Reel

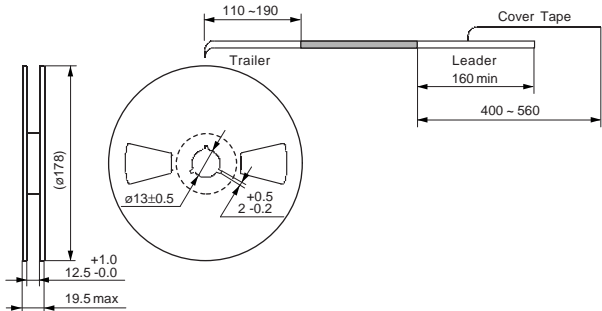

(in mm)

### ■ Dimensions of Taping

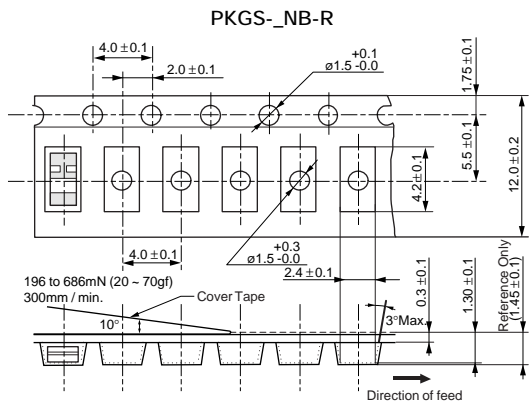

(in mm)

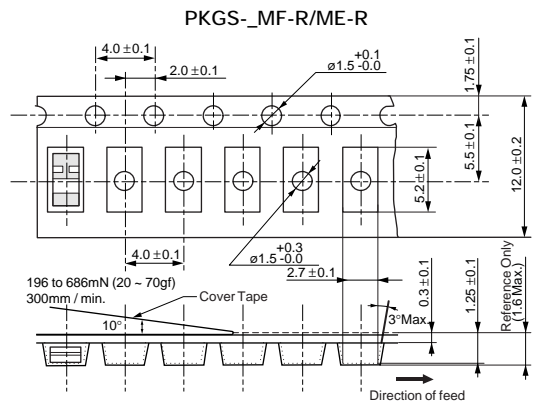

(in mm)

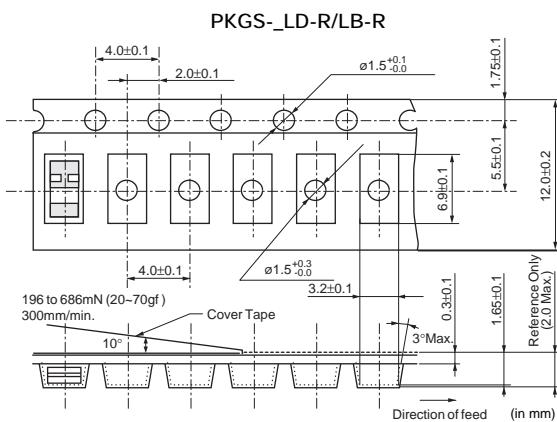

(in mm)

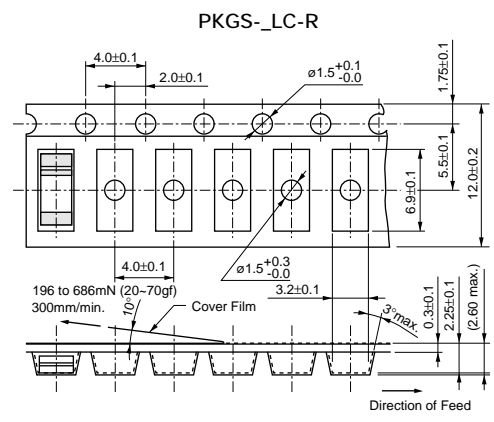

(in mm)