

High IIP3 PIN Diode Variable Attenuator
1.70-2.00 GHz

MA4VAT2004-1061T
V2

Features

- RoHs and ELV compliant
- 1.4 dB Insertion Loss, Typical
- 1.4:1 VSWR, Typical
- 21 dB Attenuation, Typical
- 45 dBm IIP3, Typical
(1 MHz Offset, @ + 0 dBm Pinc)
- 0 – 1.66 Volts Control Voltage @ 1.50 mA Typical

Extra Features

- Covers the following Bands:
 - DCS
 - PCS
 - UMTS/WCDMA/CDMA
 - TD-S_CDMA
 - SCDMA
- Usable Bandwidth: 1.50 GHz to 2.50 GHz
- 1.8 dB Insertion Loss, Typical
- 2:1 VSWR, Typical
- 18.5 dB Attenuation, Typical

Description and Applications

M/A-COM's MA4VAT2004-1061T is a HMIC PIN Diode Variable Attenuator which utilizes an integrated 90 degree 3dB hybrid with a pair of Silicon PIN Diodes to perform the required attenuation function as D.C. Voltage (Current) is applied.

This device operates from 0 to 1.66 Volts at 1.50mA typical control current for maximum attenuation. The user can add external biasing resistors to the bias ports for higher voltage requirements as required.

M/A-COM's MA4VAT2004-1061T PIN Diode Variable Attenuator is designed for AGC Circuit Applications requiring:

- Lower Insertion Loss
- Lower distortion through attenuation
- Large dynamic range for wide spread spectrum applications

PIN Configuration (Topview)

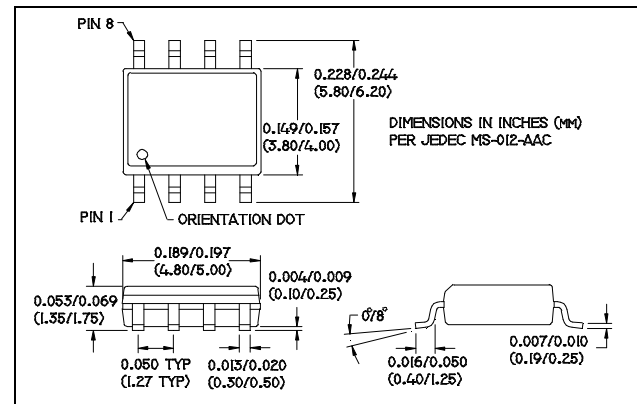

PIN Configuration (Topview)

PIN	Function	Comments
1	DC1	
2	GND	
3	GND	
4	RFin/out	Symetrical as RF Input/Ouput
5	RFout/in	Symetrical as RF Input/Ouput
6	GND	
7	GND	
8	DC2	

Absolute Maximum Ratings^{1,2}
@ T = +25 °C

Parameter	Maximum Ratings
Operating Temperature	-40 °C to +85 °C
Storage Temperature	-65 °C to +150 °C
Junction Temperature	+175 °C
RF C.W. Incident Power	+33 dBm C.W.
Reversed Current @ -30 V	I -50nA I
Control Current	50mA per Diode

1. All the above are at Room Temperature except as noted
2. Exceeding the above Limits may cause permanent damage

High IIP3 PIN Diode Variable Attenuator
1.70-2.00 GHz

MA4VAT2004-1061T
V2

Electrical Specifications @ +25 °C

Parameter	Frequency Band	Unit	Min	Typ	Max
No DC Bias Low Loss State					
Insertion Loss	1.70 GHz – 2.00 GHz	dB	-	1.4	1.8
Input Return Loss		dB	13	15	-
Output Return Loss		dB	13	15	-
P1dB		dBm	30	-	-
IIP3		dBm	47	49	-
Control Voltage		V	-	0V @ 0uA	-
DC Bias RF Attenuation State					
Maximum Attenuation	1.70 GHz – 2.00 GHz	dB	20	24	-
Input Return Loss @ Max Attenuation		dB	18	21	-
Output Return Loss @ Max Attenuation		dB	18	21	-
IP3		dBm	36	39	-
Control Voltage @ Max Attenuation		V	-	1.66V @ 1.50mA	-

Typical RF Performance Over Industry Designated RF Frequency Bands

Band		Freq	I. Loss	Att.	R. Loss	IIP3	Phase -Relative-
		(MHz)	(dB)	(dB)	(dB)	(dBm)	(Degree)
DCS	RX	1710-1785	1.6	22	13	50	+15°
	TX	1805-1880	1.6	22	13	50	
PCS	RX	1850-1910	1.6	21	13	50	+10°
	TX	1930-1990	1.6	21	13	50	
UMTS	RX	1920-1980	1.6	20	13	50	-5°
WCDMA/CDMA	TX	2110-2170	1.8	20	13	50	
TD-S-CDMA	-	2010-2025	1.7	20	13	50	-2°
SCDMA	-	1800-2200	1.8	20	13	50	-10°

1. All are typical values only.
2. Relative phase is the measured Insertion Phase Difference between Insertion Loss and the 20dB Attenuation State.
(Please refer to the plots below)

**High IIP3 PIN Diode Variable Attenuator
1.70-2.00 GHz**

**MA4VAT2004-1061T
V2**

Plots of Typical RF Characteristics @ + 25 °C

Typical Insertion Loss & Attenuation Plot

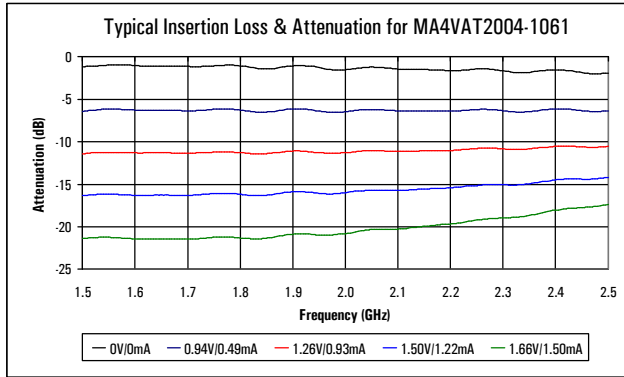

Typical Attenuation Vs Voltage Plot

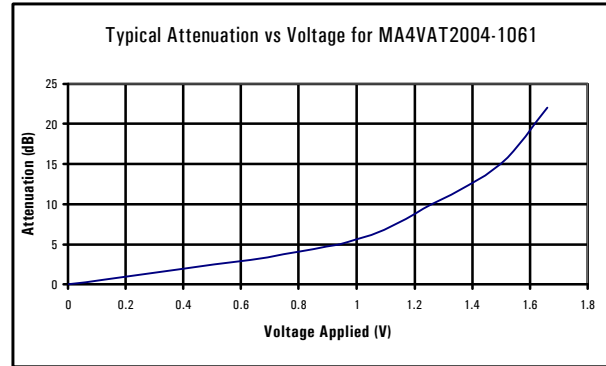

Typical Return Loss @ All Attenuation Levels Plot

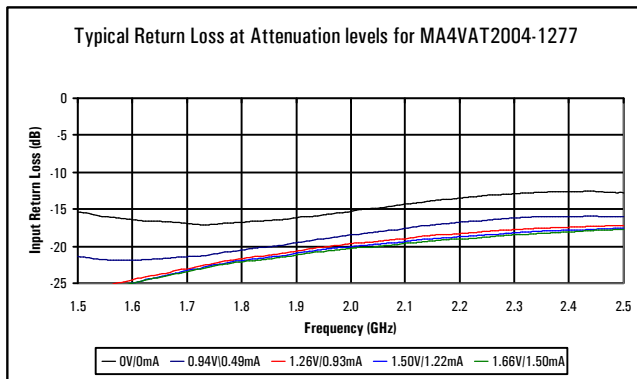

Typical IIP3 Vs Attenuation Plot

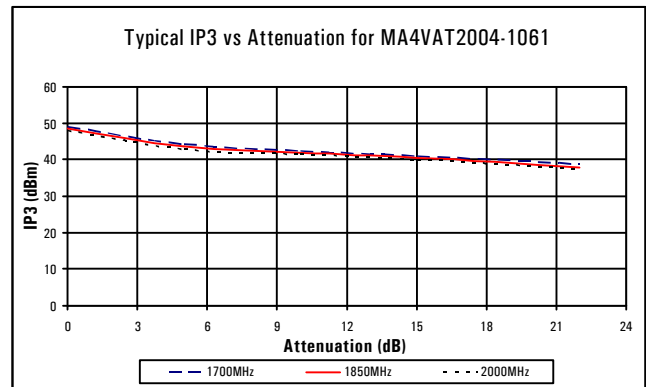

Typical Relative Phase Shift Per Attenuation (Voltage) Plot

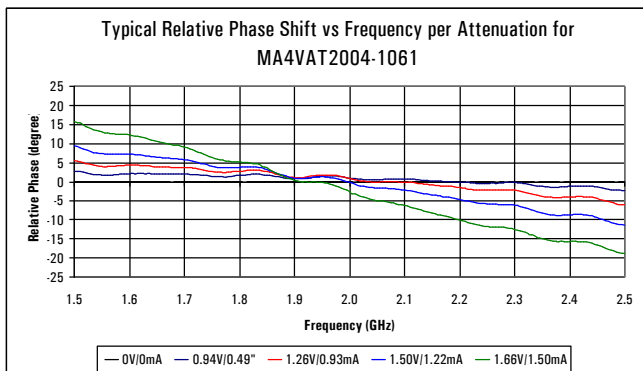

For Reference ONLY:

- Low Loss = 0.00V, @0.00mA
- 5 dB Attenuation = 0.94V, @0.49mA
- 10 dB Attenuation = 1.26V, @0.93mA
- 15 dB Attenuation = 1.50V, @1.22mA
- 20 dB Attenuation = 1.66V, @1.50mA

High IIP3 PIN Diode Variable Attenuator
1.70-2.00 GHz

MA4VAT2004-1061T
V2

Package Pin Designation, External Components, and Equivalent Circuit

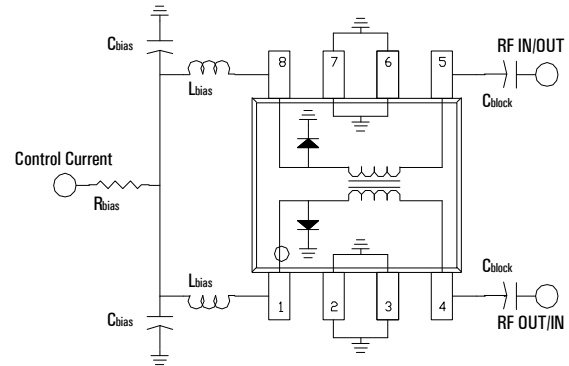
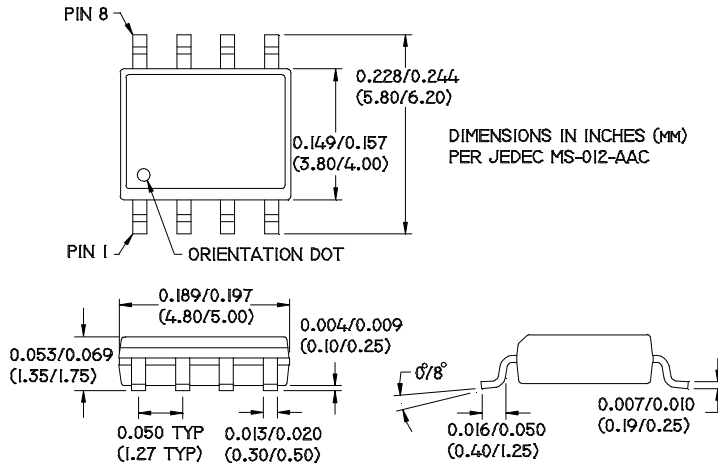

External Bias Components

R_{bias} = 680 Ohms (1.66 V, 1.50 mA)
 L_{bias} = 150 nH
 C_{bias} = 100 pF
 C_{block} = 100 pF

Ordering Information

Part Number	Package
MA4VAT2004-1061T	Tape and Reel