

AC Variable Speed Drives for Industry

0.37-500kW



IMO Precision Controls Limited
 1000 North Circular Road
 Staples Corner, London NW2 7JP
 United Kingdom
 Tel: +44 (0)20 8452 6444
 Fax: +44 (0)20 8452 3512
 Email: imo@imopc.com
 Web: www.imopc.com



- Cam Switches
- Din Terminals
- Enclosures
- Fieldbus remote I/O
- Isolators & Switch Fuses
- MCB & RCD
- Motor Circuit Breakers
- Motor Control Gear
- Panel Meters
- Relays
- Signal Conditioning
- Sockets
- Timers
- Transformers & Power Supplies

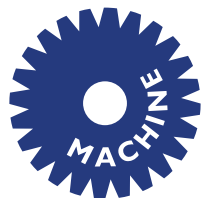

- Drives
- Intelligent Terminals/HMI
- Limit Switches
- Photoelectric Switches
- PLCs
- Proximity Switches
- Temperature Controls



- Data Acquisition & Control
- Drives
- Intelligent Terminals/HMI
- Limit Switches
- Photoelectric Switches
- Proximity Switches
- PLCs
- Signal Conditioning
- Temperature Controls



- Lightguards
- Safety Limit Switches
- Safety Relays



- Jaguar VXM 0.4-400KW
- Jaguar VXSM 0.2-4.0kW
- Jaguar CUBCM 0.2-2.2KW

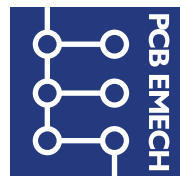

- Audible devices
- Chip-on-Board
- Device programmers
- LEDs & 7 seg. displays
- PCB Terminal blocks
- Relays - automotive
- Relays - power
- Relays - signal
- Switches

All IMO products are tried, tested and approved to relevant international quality standards



IMO has been manufacturing innovative control components since 1970.

The continuous expansion of the company's manufacturing resources and the development of strategic alliances with manufacturing centres of excellence have produced one of the finest ranges of automation and controls products available today.

The first company in Europe to do so, IMO gives a no-quibble Three Year Warranty on the majority of its electronics based control components and a Five Year Warranty on the full range of Jaguar Drives.

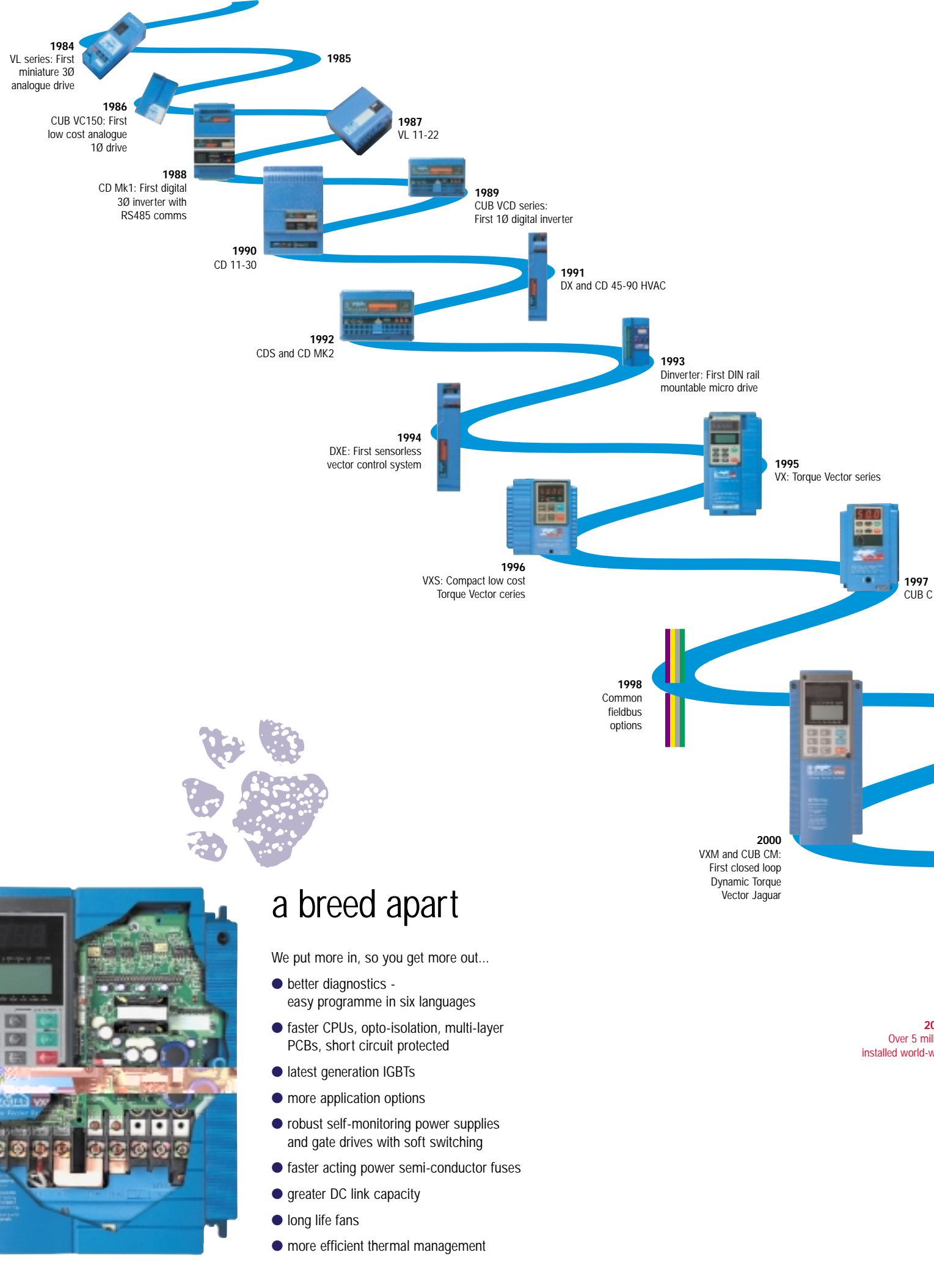

IMO Jaguar *the drive for perfection*

Welcome to the latest in what you can see is a long and distinguished line of IMO Jaguar AC variable speed drives.

The product of twenty years continuous innovation, today's range, comprising single and three phase CUB and VXSM series from 0.37kW and three phase VXM series up to 500kW, remains at the forefront of frequency inverter technology.

Just as important, with all this experience behind us, our engineers have the edge in application expertise and sheer drive know-how to help, without hassle, customers achieve their optimum solution. And boasting the largest stock of AC drives in the country, backed as always by our unique five year guarantee, you can be confident we'll deliver.



IMO Jaguar. The technology... the support... the drive.



a breed apart

We put more in, so you get more out...

- better diagnostics - easy programme in six languages
- faster CPUs, opto-isolation, multi-layer PCBs, short circuit protected
- latest generation IGBTs
- more application options
- robust self-monitoring power supplies and gate drives with soft switching
- faster acting power semi-conductor fuses
- greater DC link capacity
- long life fans
- more efficient thermal management



2002
Over 5 million
installed world-wide



2004
CUB: First 1Ø
and 3Ø series



2003
TE: IP54
and LE:
Lift/hoist
specific

IMO Jaguar VXSM general purpose drives

1Ø: 0.37-2.2kW
3Ø: 0.37-7.5kW

Compact High Performance

Starting Torque 200%+. On line tuning. Static and Dynamic Motor Tuning. Dynamic Torque Vector principle. Smaller size, height 130mm to 4kW.

Removable Display

Machine Speed, Hertz, Amps, Volts, or Motor Speed

Advanced communications

RS485 / Modbus RTU port standard, Windows based programming. Profibus DP, Devicenet, Modbus +, InterbusS options

Enhanced features

Up to 15 preset speeds, bi-polar mode, PID control, input and output phase loss protection, PTC thermistor, 2 programmable outputs, cooling fan on/off, torque limiters, PID control. Spinning motor pickup

Maintenance Information

Preventative maintenance information
Overheat early warning

Automatic energy saving mode

EMC friendly
Soft Switching transistor technology. Low 'noise' control power design (half resonance switching technology). Filter options and chokes to suit the application environment

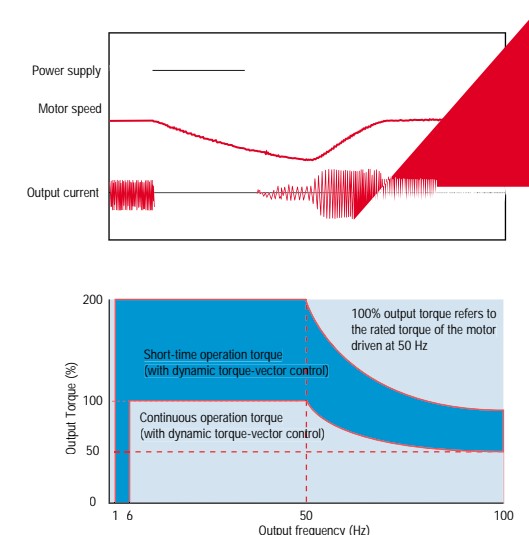

42

Frame size	H (mm)	W (mm)
1	130	70
2	130	106
3	130	170
4	220	180

Part Number VXSM...	1 phase input 200-240V ±10%; 50/60Hz ±5%				3 phase input 380-480V +10% -15% 50/60Hz ±5%						
	40-1	75-1	150-1	220-1	40-3	75-3	150-3	220-3	400-3	550-3	750-3
Motor Rating(kW)	0.37/0.55	0.75/1.1	1.5	2.2	0.37/0.55	0.75/1.1	1.5	2.2	3.7/4.0	5.5	7.5
Rated output current (A)	3 (2.5)	5 (4)	8 (7)	11 (10)	1.5 (1.4)	2.5 (2.1)	3.7	5.5 (5.3)	9 (8.7)	13 (12)	18 (16)
Frame size (H x W)	1	2	3	3	2	2	2	2	3	4	4
Depth (mm)	118	126	158	158	126	150	170	170	158	158	158
Weight (kg)	0.7	1.2	1.8	1.9	1.1	1.2	1.3	1.4	1.9	4.5	4.5

Notes: 1. Overload capability. 150% rated current for 60 seconds, 200% for 0.5 seconds
2. All output current ratings shown in () are for operation at >40C ambient and/or >4kHz carrier



actual size

IMO Jaguar VXM high performance drives

3Ø: 0.4-500kW

High Performance

Starting Torque up from 150% to 200% open loop at 0.5Hz, bi-polar input. Torque control. PID control. Closed Loop (EFC), 1200:1 speed range, fast torque response (40Hz), 150% holding at zero speed, 0.02% speedholding

Fully Rated

High overload capability, at 50°C and all carrier frequencies (15kHz<75kW), no derating!

Dual Rating

More flexibility and rationalization

Remotable Dual Display

A bright 4 digit 16mm LED, 10 different engineering units: Hz, Amps, Volts, Torque, kW etc. Plus a 4 line 13 character backlit LCD for text readouts and programming with status indicators

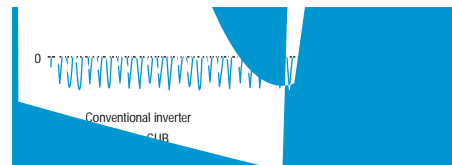

Communications

RS485/Modbus RTU port standard, Windows based programming package at no extra charge. Popular fieldbuses, Profibus DP, Devicenet, Modbus +, InterbusS

Maintenance Information

Preventative maintenance information. Overheat and overload early warning

EMC friendly

Soft Switching transistor technology. Low 'noise' control power design (half resonance switching technology). Filter options and chokes to suit the application environment

Enhanced features

PID, phase loss, PTC thermistor i/p, programmable 9 i/ps and 5 o/ps, fan on/off, on-line tuning, 2 analogue o/ps etc. Options 4 Encoder Feedback Cards including synchronisation, Braking modules, I/O add ons etc.

Automatic energy saving mode

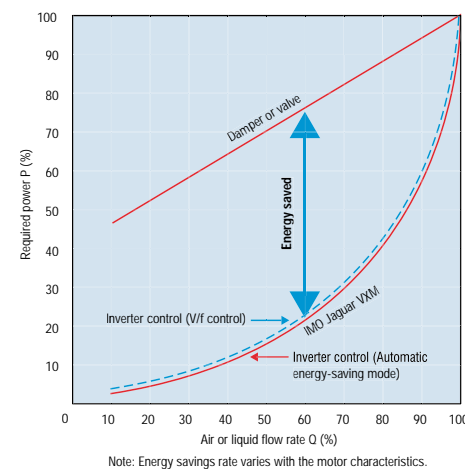
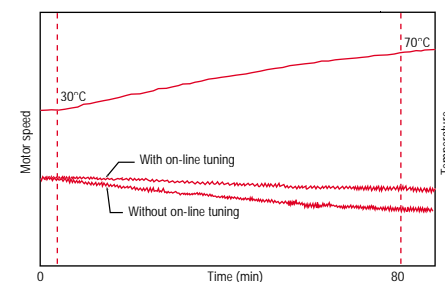

actual size

3 phase input
380-480V +10% -15%, 50/60Hz ±5%

Part Number VXM...	40	75	150	220	400	550	750	1100	1500	1850	2200	30KP	30K	37K	45K	55K	75K	90K	110K	132K	160K	200K	220K	280K	315K	355K	400K
Motor Rating (kW)	NT					7.5	11	15	18.5	22		30	37	45	55	75	90	110	132	160	200	220	280	315	355	400	500
	HT	0.37/0.55	0.75/1.1	1.5	2.2	3.7/4.0	5.5	7.5	11	15	18.5	22	30	37	45	55	75	90	110	132	160	200	220	280	315	355	400
Rated output current (A)	NT					16.5	24	30	37	44		60	75	91	112	150	176	212	253	304	377	415	520	585	650	740	840
	HT	1.5	2.5	3.7	5.5	9	13	18	25	30	37	45	60	75	91	112	150	176	212	253	304	377	415	520	585	650	740

NT: Suitable for normal/lighter loads and variable torque applications. Overload capability. 110% rated current for 60 seconds.

HT: Suitable for higher starting torques and sustained overloads. Overload capability. 150% rated current for 60 seconds, 200% for 0.5 seconds

IMO Jaguar VXM LE for lifts/hoists/cranes

3Ø: 0.37-400kW

Designed using standard VXM technology, but with additional features ideally suited to lift, elevator and crane control systems - making it ideal for machine room retrofit or MRL applications - with gearless solutions if required.

- Quiet Operation - high carrier frequency of 15kHz PWM waveform
- Brake Control - by output ensuring smooth take-off and stopping
- Anti-jerk - up to 4 acceleration/ deceleration ramps with adjustable 'S' smoothing
- Speeds - preset speeds (binary selection) for travel, levelling, creep, engineering maintenance and so on
- High overload capability - to accelerate high inertia loads
- Rescue mode - can utilize low voltage DC battery in state of power failure
- MC control (with timers)
- Anti-rollback software (two types)
- Zero speed (closed loop) capability

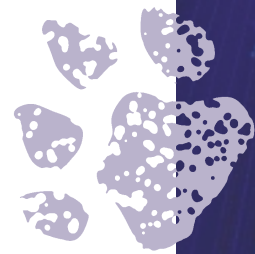

safety first...
specify IMO Jaguar!

for applications including...

- lifts (passenger)
- hoists (goods)
- elevators

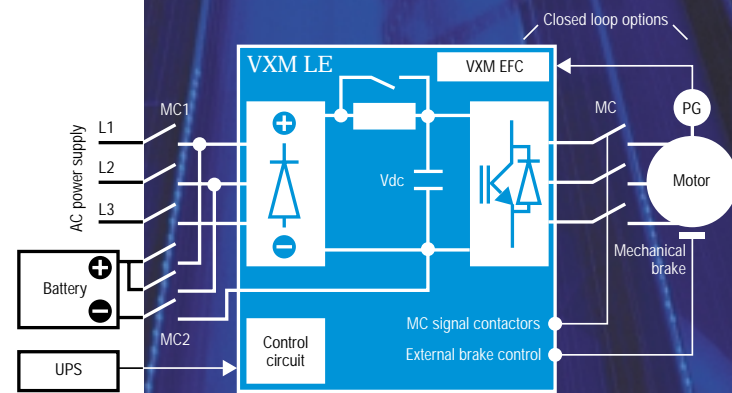

Part number VXM...	3 phase input 380-480V, 50/60Hz						
	400LE	550LE	750LE	1100LE	1500LE	1850LE	2200LE
Motor rating (kW)	4	5.5	7.5	11	15	18	22
Rated output current (A)	9	16.5	23	30	37	44	45
	Overload 60s	14.5	19.5	27	36	45	67
	Overload 5s	16	24	34	46	58	88
Duty	50%						
Rated input current (A)	With DCR	7.1	13.5	19.8	26.8	33.2	39.3
	No DCR	14.9	27.9	39.1	50.3	59.9	69.3

For further details of higher power ratings, please contact IMO

IMO Jaguar VXM TE the Jag-in-the-box!

3Ø: 7.5-45kW

Out of the packaging and on the wall - the instant engineering solution!
The Jaguar TE is based upon our flagship drive, the VXM and supplied in it's own mild steel enclosure, pre-wired with standard controls and features as listed.

- Sensorless and closed loop vector control
- Automatic energy saving
- Parameter quick-copy facility
- Service due/lifetime indication
- Thermal overload
- 40°C/4kHz PWM operation at full load
- Dual rated for normal/heavy duty loads

totally enclosed,
totally reliable,
come rain
or shine



- instant solutions for the plant room, boiler house or factory floor!

Frame size	H(mm)	W(mm)	D(mm)
1	500	400	300
2	600	400	300
3	800	600	450
4	800	800	500

Part Number VXM...	3 phase input 380-480V, 50/60Hz						380-440V, 50Hz / 380-480V, 60Hz			
	550TE	750TE	1100TE	1500TE	1850TE	2200TE	30KPTE	30KTE	37KTE	
Motor Rating (kW)	NT	7.5	11	15	18.5	22	N/A	30	37	45
	HT	5.5	7.5	11	15	18.5	22	N/A	30	37
Rated output current (A)	NT	16.5	23	30	37	44	45	60	75	91
	HT	13	18	24	30	39	45	60	60	75
Enclosure rating	IP54									
Enclosure size	1	1	2	2	2	2	3	3	4	

NT: Suitable for normal/lighter loads and variable torque applications.
HT: Suitable for higher starting torques and sustained overloads.





Alarm monitor[----- Demo Mode -----]

OC1 Over current during acceleration

Operating data at alarm:	Operating status at alarm:
Frequency 30.00Hz	Powered on time 33s
Torque 120.00%	DC link voltage 255V
Torque current 130.00%	Internal temperature 58deg C
Motor output 95.00%	Heatsink temperature 68deg C
Output current 130.00%	
Output voltage 125V.0V	
Operation status FWD LU	

Command monitor at alarm:	Input status at alarm:	Output status at alarm:
Frequency 60.00Hz	<input checked="" type="checkbox"/> FWD	<input checked="" type="checkbox"/> Out
Torque 0.00%	<input type="checkbox"/> REV	<input type="checkbox"/> Stop
Torque current 0.00%	<input type="checkbox"/> J1	<input type="checkbox"/> Stop
Motor output 0.00%	<input type="checkbox"/> J2	<input type="checkbox"/> Stop

IMO Jaguar *at your service*

Variable Speed Drives, as with any sophisticated industrial electronic device, may sometimes malfunction or occasionally fail, possibly due to environmental conditions or installation problems.

IMO has a nationwide team of dedicated engineers for just such an occasion.

maintenance contracts

For total peace of mind, a maintenance contract will cover all your inverters on site. Depending upon the type of cover required, we guarantee to have a service engineer call to repair or exchange a faulty drive within a specified time, just by picking up the phone.

site surveys

Our engineers have the equipment, experience and training to carry out full site surveys for both energy saving applications and harmonic analysis. Periodic surveys can identify drives which may need replacement before an expensive breakdown occurs.

commissioning

Make sure your Jaguar inverters give long and reliable operation right from the start by having your system set up by professionals.

repair service

A full diagnosis and repair service is available including post repair on-load testing at our London and Oldham Service Centres. Drives (especially the larger models) can be repaired on site, saving time and cost of labour and carriage.

IMO Jaguar *drive academy*

At IMO Jaguar's 'Drive Academy', we run courses to cater for all levels of training, from beginner to expert, at specially designed facilities in either Oldham or Staples Corner, London.

Usually lasting a day, a standard course covers drive set up, installation, operation and fault finding, with the emphasis on hands-on training.

Ideal for maintenance electricians, installation engineers and those involved with drives on a day-to-day basis, full documentation is provided including software.

Training sessions can also be arranged at users premises.

We also host free monthly workshops for customers (established, new and prospective) who wish to broaden their knowledge of drive applications. Typically, subjects include: harmonics, EMC, legislation and responsibility, braking, energy efficiency, closed loop, software and drive design and technology. These workshops are best suited for managers and design and project engineers. Workshops include practical demonstration of most topics, supported by full documentation including variable reference theory.

Workshop places are strictly limited, so book early to avoid disappointment.

top of the class

