

HDSP-H5x1/H5x3

0.52" Single Digit PCB Based LED Display

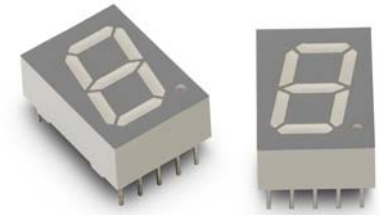

Data Sheet



Description

The HDSP-H5x1/H5x3 is a 052 inch high, single-digit display series. These halogenated devices utilize AlInGaP red, orange, green and deep red chips. This device is halogenated.

All devices are categorized for luminous intensity. The orange and green devices are categorized for color. Use of similar device categories yields a uniform display.

Features

- High reliability
- Excellent characters appearance
- Available in CA and CC
- RoHS Compliant
- Gray top surface with white diffused segments.

Table 1 Ordering Information

| Red | Green | Orange | Deep Red | Description |
|-----------|-----------|-----------|-----------|------------------------------------|
| HDSP-H5E1 | HDSP-H5G1 | HDSP-H5L1 | HDSP-H5A1 | Common Anode, Right Hand Decimal |
| HDSP-H5E3 | HDSP-H5G3 | HDSP-H5L3 | HDSP-H5A3 | Common Cathode, Right Hand Decimal |

Figure 1 Package Dimension

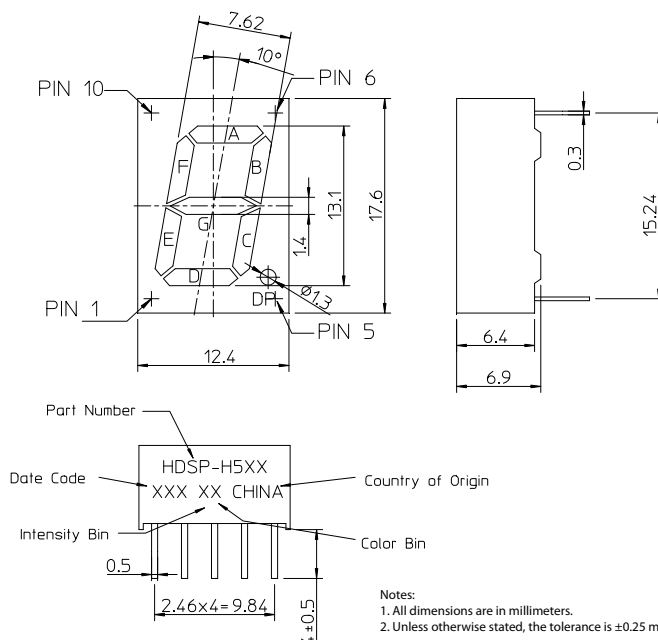

Figure 2 Circuit Diagram

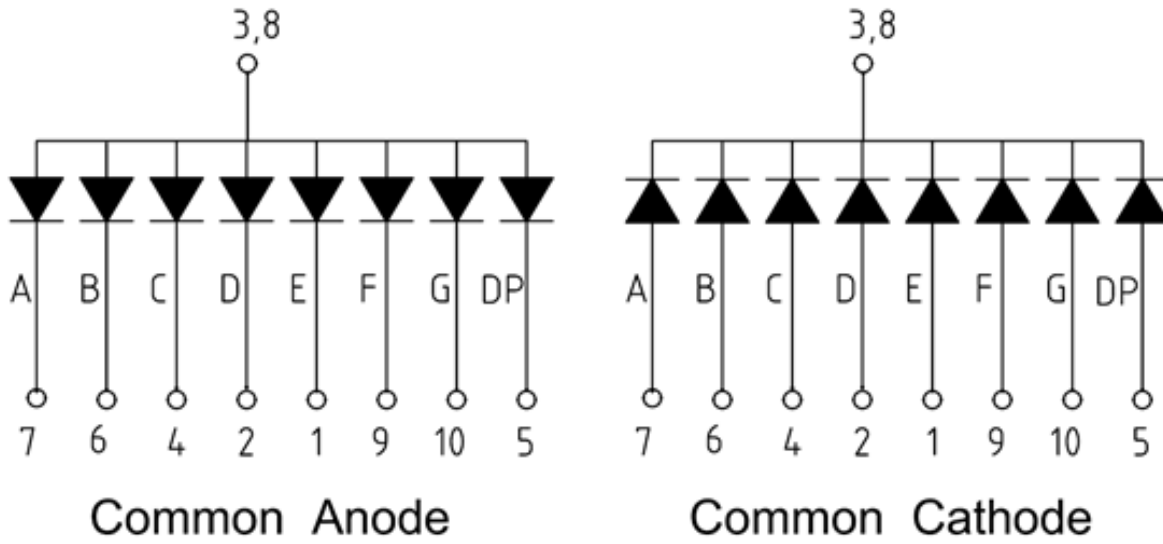

Table 2 Absolute Maximum Ratings at $T_A = 25^\circ\text{C}$

| Parameter | Symbol | Red/Orange/Green/Deep Red | Units |
|---|--------|--|----------------------|
| Power Dissipation per segment or Dot Point (DP) | P_D | 52 | mW |
| Continuous Forward Current per segment | I_F | 20 | mA |
| Peak Forward Current per segment (1/10 Duty Cycle, 0.1m sec pulse width) | | 100 | mA |
| Derating Linearly from 25°C per segment | | 0.21 | mA/ $^\circ\text{C}$ |
| Reverse Voltage per segment or DP | V_R | Not designed for reverse biasing | |
| Operating Temperature | T_O | -40 to 85 | $^\circ\text{C}$ |
| Storage Temperature | T_S | -40 to 85 | $^\circ\text{C}$ |
| Wave solder Condition 1.6mm below body | | 260 $^\circ\text{C}$ peak for 3 secs max | |

Table 3 Red Electrical/Optical Characteristics at $T_A = 25^\circ\text{C}$

| Parameter | Symbol | Min | Typ | Max | Units | Test Conditions |
|---|-------------|-----|-----|-----|---------------|----------------------|
| Average Luminous Intensity (Digit Average) | I_V | — | 40 | — | mcd | $I_F = 10\text{ mA}$ |
| Peak Wavelength | λ_p | — | 634 | — | nm | $I_F = 20\text{ mA}$ |
| Dominant Wavelength | λ_d | — | 625 | — | nm | $I_F = 20\text{ mA}$ |
| Forward Voltage per segment / DP | V_F | — | 2.0 | 2.6 | V | $I_F = 20\text{ mA}$ |
| Reverse Current per segment / DP ^a | I_R | — | — | 100 | μA | $V_R = 5\text{ V}$ |
| Luminous Intensity Matching Ratio (Segment to Segment) | I_{V-M} | — | 2:1 | — | — | $I_F = 10\text{ mA}$ |

a. Indicates production go-no-go test only. Long term reverse biasing is not recommended.

Table 4 Green Electrical/Optical Characteristics at $T_A = 25^\circ\text{C}$

| Parameter | Symbol | Min | Typ | Max | Units | Test Conditions |
|--|-------------|-----|-----|-----|---------------|----------------------|
| Average Luminous Intensity (Digit Average) | I_V | — | 15 | — | mcd | $I_F = 10\text{ mA}$ |
| Peak Wavelength | λ_p | — | 570 | — | nm | $I_F = 20\text{ mA}$ |
| Dominant Wavelength | λ_d | — | 571 | — | nm | $I_F = 20\text{ mA}$ |
| Forward Voltage per segment / DP | V_F | — | 2.0 | 2.6 | V | $I_F = 20\text{ mA}$ |
| Reverse Current per segment / DP ^a | I_R | — | — | 100 | μA | $V_R = 5\text{ V}$ |
| Luminous Intensity Matching Ratio (Segment to Segment) | I_{V-M} | — | 2:1 | — | — | $I_F = 10\text{ mA}$ |

a. Indicates production go-no-go test only. Long term reverse biasing is not recommended.

Table 5 Orange Electrical/Optical Characteristics at $T_A = 25^\circ\text{C}$

| Parameter | Symbol | Min | Typ | Max | Units | Test Conditions |
|--|-------------|-----|-----|-----|---------------|----------------------|
| Average Luminous Intensity (Digit Average) | I_V | — | 40 | — | mcd | $I_F = 10\text{ mA}$ |
| Peak Wavelength | λ_p | — | 610 | — | nm | $I_F = 20\text{ mA}$ |
| Dominant Wavelength | λ_d | — | 605 | — | nm | $I_F = 20\text{ mA}$ |
| Forward Voltage per segment / DP | V_F | — | 2.0 | 2.6 | V | $I_F = 20\text{ mA}$ |
| Reverse Current per segment / DP ^a | I_R | — | — | 100 | μA | $V_R = 5\text{ V}$ |
| Luminous Intensity Matching Ratio (Segment to Segment) | I_{V-M} | — | 2:1 | — | — | $I_F = 10\text{ mA}$ |

a. Indicates production go-no-go test only. Long term reverse biasing is not recommended.

Table 6 Deep Red Electrical/Optical Characteristics at $T_A = 25^\circ\text{C}$

| Parameter | Symbol | Min | Typ | Max | Units | Test Conditions |
|--|-------------|-----|-----|-----|---------------|----------------------|
| Average Luminous Intensity (Digit Average) | I_V | — | 35 | — | mcd | $I_F = 10\text{ mA}$ |
| Peak Wavelength | λ_p | — | 644 | — | nm | $I_F = 20\text{ mA}$ |
| Dominant Wavelength | λ_d | — | 635 | — | nm | $I_F = 20\text{ mA}$ |
| Forward Voltage per segment / DP | V_F | — | 2.0 | 2.6 | V | $I_F = 20\text{ mA}$ |
| Reverse Current per segment / DP ^a | I_R | — | — | 100 | μA | 5 V |
| Luminous Intensity Matching Ratio (Segment to Segment) | I_{V-M} | — | 2:1 | — | — | $I_F = 10\text{ mA}$ |

a. Indicates production go-no-go test only. Long term reverse biasing is not recommended.

Red

Figure 3 Relative Luminous Intensity Vs Forward Current

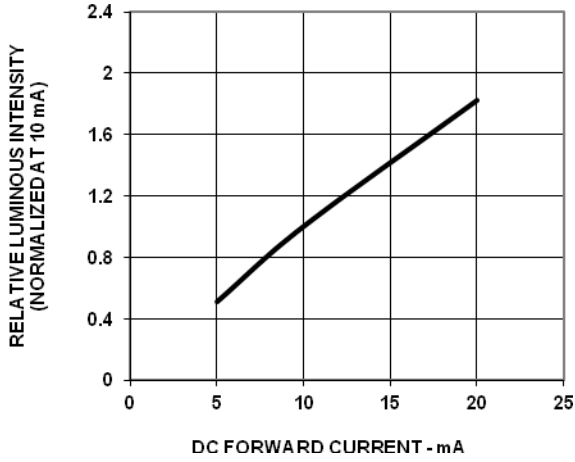

Figure 4 Forward Voltage Vs Current

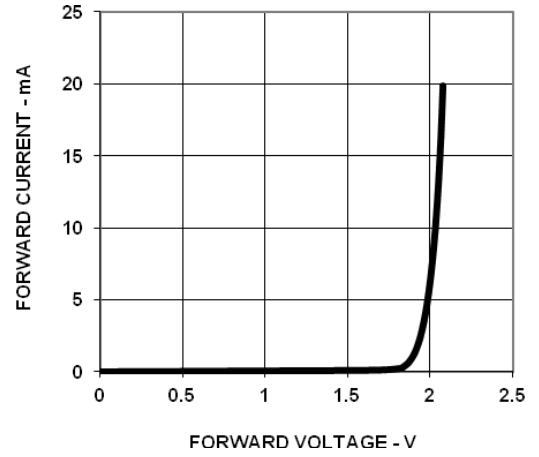
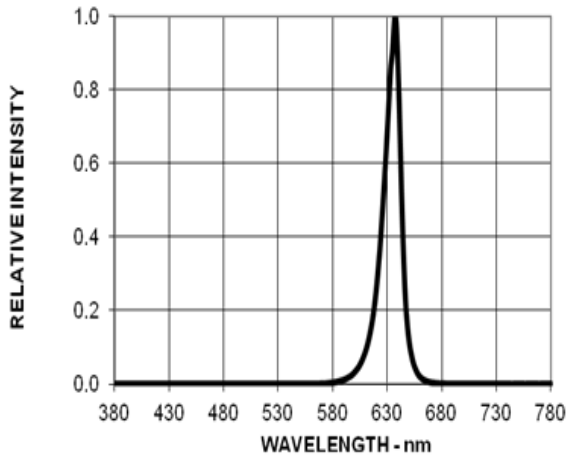

Figure 5 Relative Luminous Intensity Vs Wavelength



Green

Figure 6 Relative Luminous Intensity Vs Forward Current

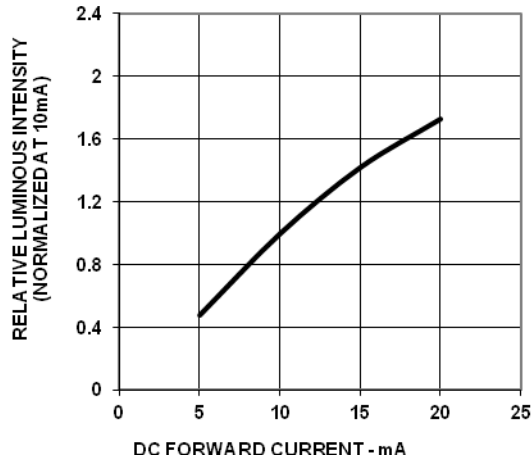

Figure 7 Forward Voltage Vs Current

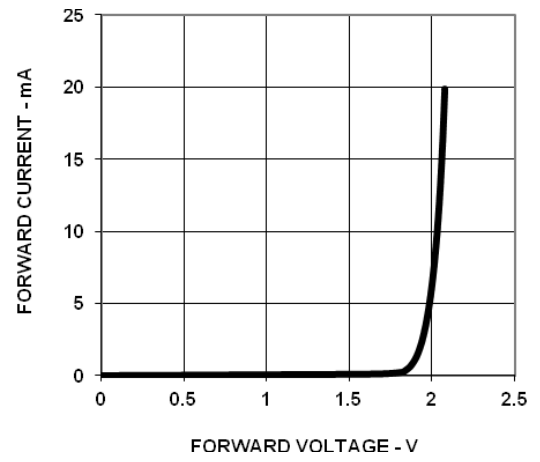
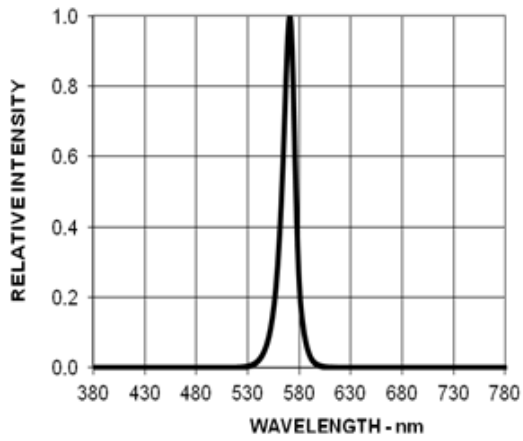

Figure 8 Relative Luminous Intensity Vs Wavelength



Orange

Figure 9 Relative Luminous Intensity Vs Forward Current

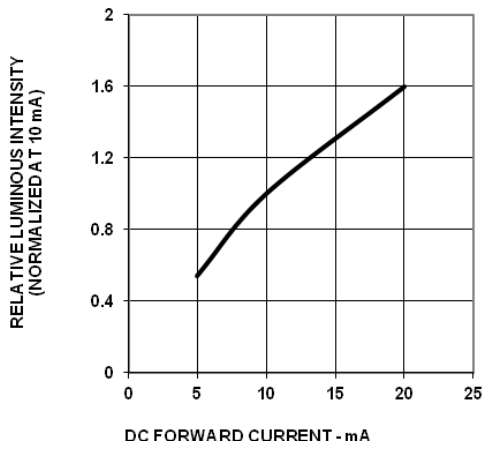

Figure 10 Forward Voltage Vs Current

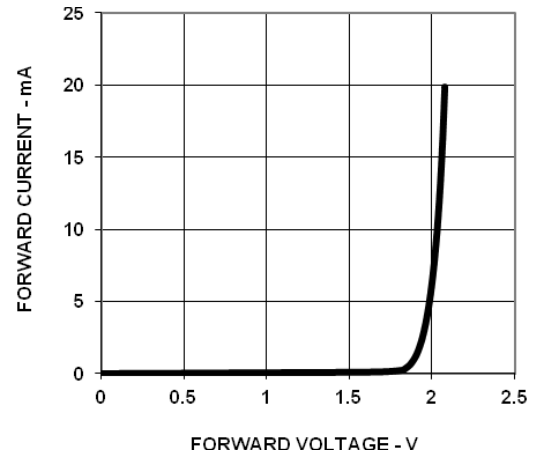
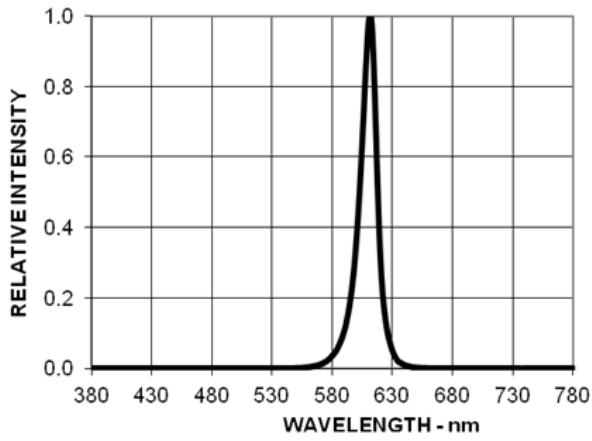

Figure 11 Relative Luminous Intensity Vs Wavelength



Deep Red

Figure 12 Relative Luminous Intensity Vs Forward Current

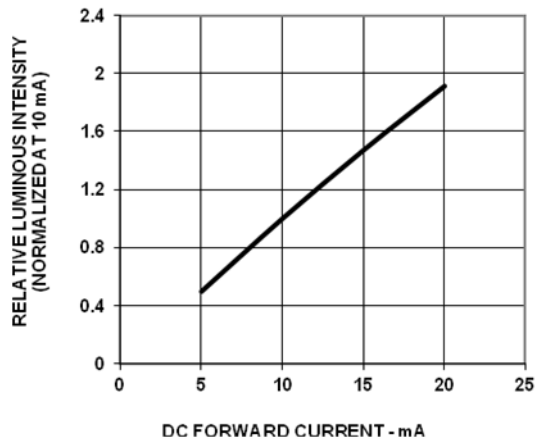

Figure 13 Forward Voltage Vs Current

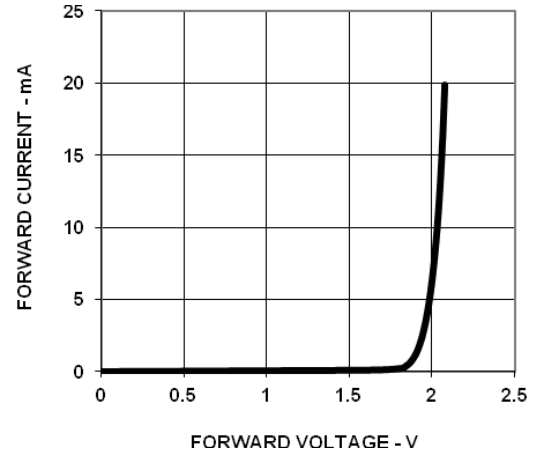
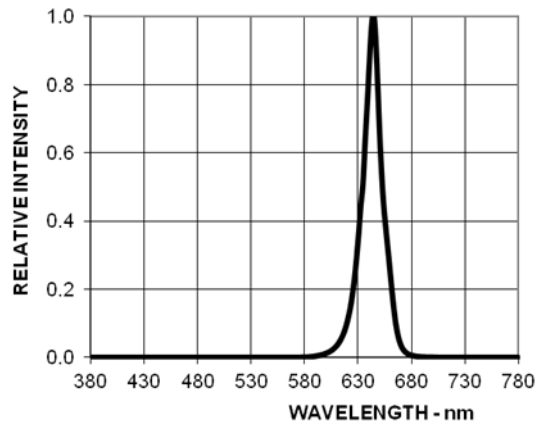
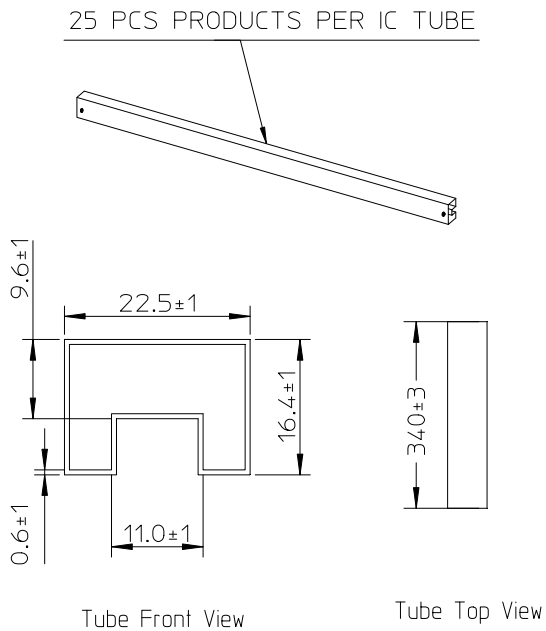

Figure 14 Relative Luminous Intensity Vs Wavelength



Packing Tube Specifications



Reference

For further information on soldering LEDs, please refer to Avago Technologies Application Note 1027.

For product information and a complete list of distributors, please go to our web site:

www.avagotech.com

Avago Technologies and the A logo are trademarks of Avago Technologies in the United States and other countries. All other brand and product names may be trademarks of their respective companies.

Data subject to change. Copyright © 2015 Avago Technologies. All Rights Reserved.

pub-005312 – December 16, 2015

AVAGO
TECHNOLOGIES