

SURFACE MOUNT SCHOTTKY BARRIER RECTIFIER

VOLTAGE RANGE 80 to 100 Volts CURRENT 1.0 Ampere

FEATURES

- * Low switching noise
- * Low forward voltage drop
- * High current capability
- * High switching capability
- * High surge capability
- * High reliability

MECHANICAL DATA

- * Case: Molded plastic
- * Epoxy: Device has UL flammability classification 94V-0
- * Lead: MIL-STD-202E method 208C guaranteed
- * Metallurgically bonded construction
- * Mounting position: Any
- * Weight: 0.098 gram

MAXIMUM RATINGS AND ELECTRICAL CHARACTERISTICS

Ratings at 25 °C ambient temperature unless otherwise specified.
 Single phase, half wave, 60 Hz, resistive or inductive load.
 For capacitive load, derate current by 20%.

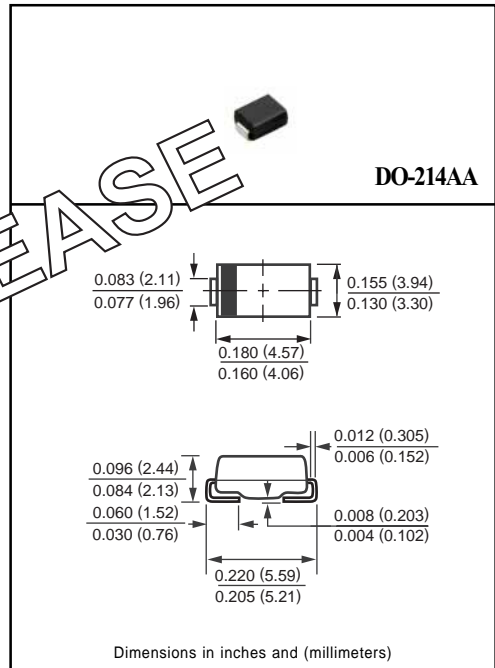

MAXIMUM RATINGS (At TA = 25°C unless otherwise noted)

| RATINGS | SYMBOL | FM180B | FM1100B | UNITS |
|---|--------|--------------|---------|-------|
| Maximum Recurrent Peak Reverse Voltage | VRRM | 80 | 100 | Volts |
| Maximum RMS Voltage | VRMS | 56 | 70 | Volts |
| Maximum DC Blocking Voltage | VDC | 80 | 100 | Volts |
| Maximum Average Forward Rectified Current at Derating Lead Temperature | IO | 1.0 | | Amps |
| Peak Forward Surge Current 8.3 ms single half sine-wave superimposed on rated load (JEDEC method) | IFSM | 40 | | Amps |
| Typical Thermal Resistance (Note 1) | RθJA | 57 | | °C/W |
| Typical Junction Capacitance (Note 2) | CJ | 110 | | pF |
| Operating Temperature Range | TJ | 150 | | °C |
| Storage Temperature Range | TSTG | -55 to + 150 | | °C |

ELECTRICAL CHARACTERISTICS (At TA = 25°C unless otherwise noted)

| CHARACTERISTICS | SYMBOL | FM180B | FM1100B | UNITS |
|--|--------|--------------|---------|-------|
| Maximum Instantaneous Forward Voltage at 1.0A DC | VF | .85 | | Volts |
| Maximum Average Reverse Current at Rated DC Blocking Voltage | IR | @ TA = 25°C | 1.0 | uA |
| | | @ TJ = 125°C | 0.5 | mA |

NOTES : 1. Thermal Resistance (Junction to Ambient): Vertical PC Board Mounting, 0.5" (12.7mm) Lead Length.
 2. Measured at 1 MHz and applied reverse voltage of 4.0 volts.

RATING AND CHARACTERISTIC CURVES (FM180B THRU FM1100B)

FIG. 1 - TYPICAL FORWARD CURRENT DERATING CURVE

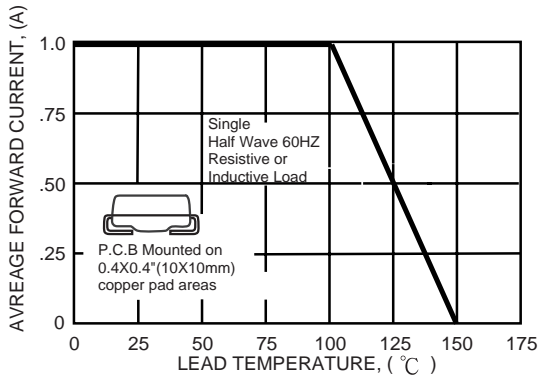

FIG. 2 - TYPICAL INSTANTANEOUS FORWARD CHARACTERISTICS

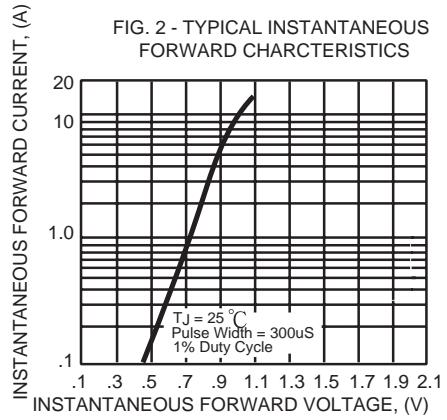

FIG. 3A - TYPICAL REVERSE CHARACTERISTICS

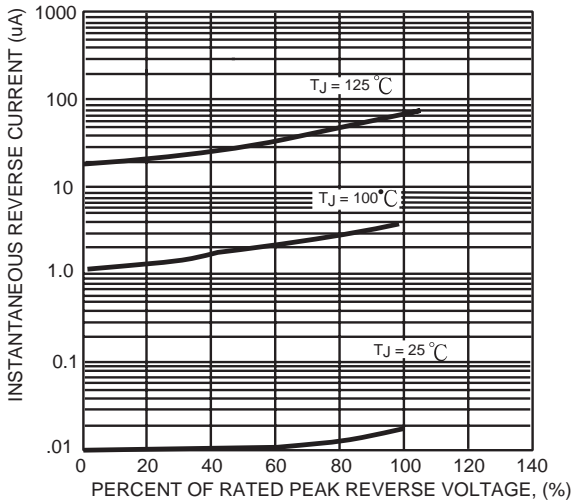

FIG. 4 - MAXIMUM NON-REPETITIVE FORWARD SURGE CURRENT

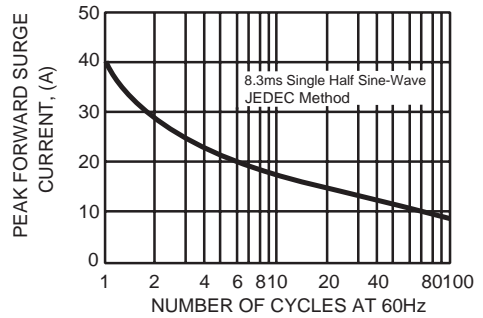
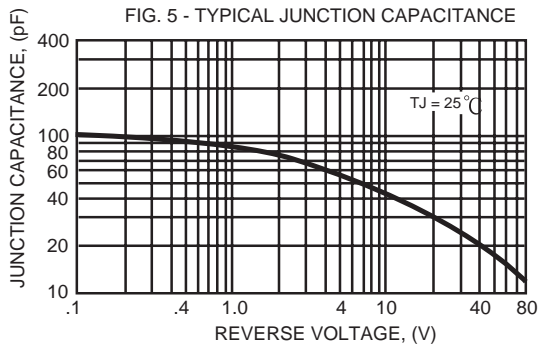
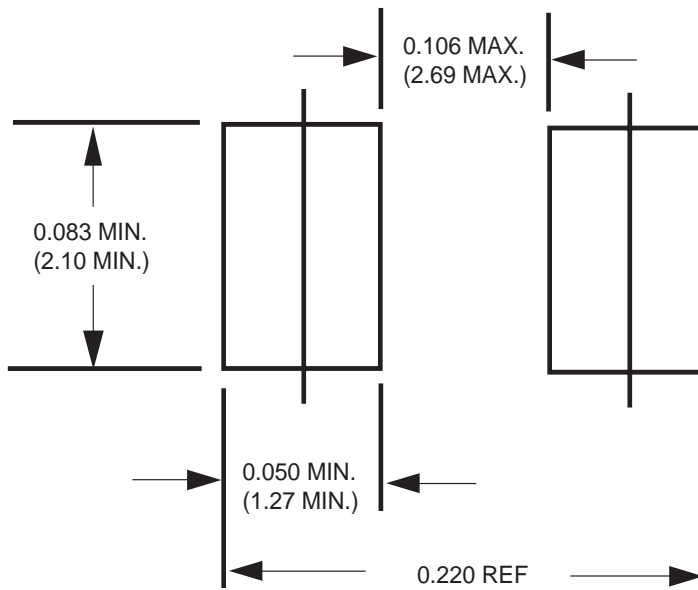

FIG. 5 - TYPICAL JUNCTION CAPACITANCE



Mounting Pad Layout



Dimensions in inches and (millimeters)