

CANNON

KPT / KPSE / KPTC Connectors

In Accordance with VG95328



ITT

ENGINEERED FOR LIFE



ITT Corporation

ITT is a diversified leading manufacturer of highly engineered critical components and customized technology solutions for the energy, transportation and industrial markets. Building on its heritage of innovation, ITT partners with its customers to deliver enduring solutions to the key industries that underpin our modern way of life. Founded in 1920, ITT is headquartered in White Plains, N.Y., with employees in more than 35 countries and sales in a total of approximately 125 countries. The company generated 2012 revenues of \$ 2.2 billion. For more information, visit www.itt.com.

Our connector portfolio remains the most extensive in the industry, offering a reliable and cost effective range of interconnect solutions with the brands of Cannon, VEAM and BIW Connector Systems. Continuous investment in technology and research & development have enabled ITT to provide new, innovative products and solutions to markets including:



Transportation



Industrial / Instrumentation



Oil & Gas



Defense Vehicles



Commercial & Military Aerospace



Automotive



Computer, Telecom & Consumer Electronics

Our connector portfolio remains the most extensive in the industry, offering a reliable and cost effective range of interconnect solutions

Introduction to KPSE/KPT/KPTC

ITT Cannon's miniature circular connector series KPT, KPSE and KPTC conform to meet the performance specification to MIL-C-26482 with a positive three point bayonet coupling, five-keyway polarization and high insert arrangement contact density.

Purpose

- General purpose solder connectors (KPT)
 - Our solution for small/prototype quantities using solder type contacts
- High versatility general purpose versions using crimp or solder contacts (KPTC)
 - Our commercial version for higher volume production with option for solder contacts
- High performance crimp connectors (KPSE)
 - Our solution for volume production optimized for fast assembly featuring “clip-in” contact & insulator design
- Military approved versions according to VG95328 or MIL-C-26482

The broad product range provides the most complete family of connectors conforming to VG95328 and MIL-C-26482 specifications.

Highlights

- All connectors conforming to the above mentioned standards are fully intermateable and accept a wide range of interchangeable accessories.
- Design modifications can be achieved easily and a lower cost using Cannons KPSE/KPT or KPTC versions
- VG95328 versions are based on MIL-C-26482 but comply to ECC directives and offer additional shielded versions
- KPTC is based on MIL-C-26482 but offers a greater versatility in contacts, backshells and plating options
- “Blue Generation” RoHS compliant, 500 hours salt spray and conductive plating is offered next to the standard Nickel, Zinc Cobalt or Cadmium platings.

Contact us for detail or your request for a customized solution.

Product overview

	KPT	KPSE	KPTC		
Material and Finishes					
Shell	Aluminum alloy Various RoHS compliant plating options are available like Zinc cobalt, Zinc Nickel and Nickel plus none compliant Cadmium	Aluminum alloy	Aluminum alloy		
Insulator	Polychloroprene	Polychloroprene	Polychloroprene		
Grommet and seal	Polychloroprene	Polychloroprene	Polychloroprene		
Contacts	Copper alloy, gold and tin plated	Copper alloy, gold and tin plated	Copper alloy, hard gold and tin plated		
Mechanical Data					
Shell styles	00 – Wall mounting receptacle	07 – Jam nut receptacle			
	01 – Cable connecting plug	08 – Plug with 90° termination assemblies			
	02 – Box mounting receptacle	B – Thru-bulkhead receptacle (KPT only)			
	06 – Straight plug				
Shell size		8 through 24			
Polarization/Coupling		Five keyways/3-point bayonet			
Service classes		A – General duty			
		E – Grommet seal			
		F – Grommet seal with strain relief			
		PG – PG gland adapters ME – metric gland adapters			
Environmental sealing	According to VG95319 Part 2, Test No. 5.9.2 For styles A to E and Z1, Z2 and Z3 and gaskets style A only, test pressure 0,2 bar overpressure, test duration 48 h, test temperature 25 ± 3°C, connector shall be free of moisture				
Operating temperature	-55/+ 125°C				
Durability	500 mating cycles				
Vibration	200 m/s ² at 10 to 2000 Hz				
Electrical Data					
Number of contacts	2 through 61	3 through 61	2 through 61		
Wire size AWG	16 through 24	12 through 24	0,4 – 2,0 mm ²		
Contact termination	Solder	Crimp	Crimp, solder		
KPT/KPSE/KPTC					
Contact rating	Size	Rated current A	Test current A	Millivolt drop mV	
	20	7,5	7,5	Less than 55	
	16	13,0	13,0	Less than 50	
Insulation resistance	~ 5000 MΩ				
Exceptions Service rating between the central contact and the housing of the coaxial contact	Test voltage	Service class		Vrms	VDC
	Seal Level	1		1500	2100
		2		2300	3200
	21336 m/70 000 ft.	1		375	535
		2		550	770
Operating voltage (with scoop proof connectors operating voltages acc. to MIL-C-26482 and VG95328 are permitted)					
Operating voltage	Service class	VG95328	MIL-C-26482		
	1	140 VDC/100 VAC	850 VDC/600 VAC		
	2	165 VDC/115 VAC	1400 VDC/1000 VAC		

Operating voltage

When the connectors in this catalogue are used for voltages greater than 50 Volts and have touchable conductive shell parts they must be used in accordance with the safety regulations DIN VDE Part 140; IEC 60364-4-41. This regulation basically dictates that the power source should be turned off before any mating and unmating of the connector. This regulation does not provide protection against electrical shock when mating and unmating the connectors in the live condition.

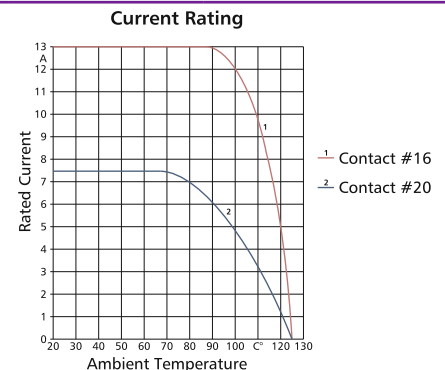

Table of contents

Product overview	5
How to use this catalogue.....	7
Part number creation	8
Ordering reference	10
Contact arrangements.....	12
Alternate insert positions.....	15
Wall mounting receptacles	16
Cable connecting plugs	17
Box mounting receptacles	18
Thru-bulkhead receptacles.....	18
Straight plugs	19
Jam nut receptacles.....	21
Right angle plugs	22

Special versions

Connectors with grounding continuity.....	23
Receptacles with straight solder pins	26

Accessories and tooling

Panel cutouts	27
Protective caps	28
Dummy receptacle	30
Cross reference lists	31
Tools and accessories	32
KPSE contact and sealing principle	33
Product safety information	34

How to use

This catalog is split in several sections that help you to

- get a general overview of all product lines (product overview)
- create a product part number step by step (part number creation OR ordering reference)
- get all required detail information (dimensions, product details)
- get all required support products (accessories, tooling)

The fastest way to find your product of choice is to follow these steps

1 **Select your product** using either the “part number creation” or “ordering reference” option

3 **Add accessories and tooling** as required on the related pages

2 **Use the detail pages** to better understand the available options and choose the best solution for your needs

4 **Use the contact information** on the back cover to contact us for further questions or to get advise on where you can purchase our products



Part number creation plug

Follow these steps to design your connector part number.

STEP 1 Select shell style (plug)

Shell Style	Plug	Shell Style	Plug	Shell Style	Plug
Plug straight	Solder KPT06 KPTC6 Crimp KPSE06	Plug straight shielded	Solder KPT6-DZ KPTC6-DZ Crimp KPSE6-DZ	Plug 90°	Solder KPT08 KPTC8 Crimp KPSE08
					

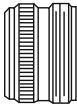
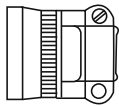
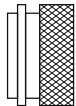
STEP 2 Choose backshell

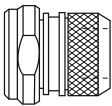
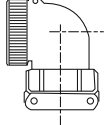
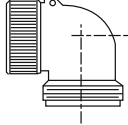
Class A General duty with thread	Class F Grommet seal with strain relief	Class E add mod. code DN Environmental, grommet seal, heat shrink boot adapter	Class PG; ME KPTC only Environmental	Class E add Mod. code DZ Environmental, grommet seal, shielded heat shrink boot adapter	Class F, 90° Grommet seal with thread and cable clamp	Class A, 90° General duty with thread Class E, 90° Grommet seal with thread
						

STEP 3 Choose layout

see page 12–14 for layouts

STEP 4 Choose gender

P=pin S=socket

STEP 5 Choose rotation

see page 15 for rotation (omit for normal position)

STEP 6 Choose modification*

see page 11 for modifications (omit if no modification is required)

* If a modification is used the initial ,0' in the shell style description is omitted e.g. KPT01 is changed to KPT1. KPTC series does never use the initial ,0' e.g. KPTC6

Design your part number as per above steps









KPSE/KPT Examples	STEP 1 Shell style	STEP 2 Class/Backshell	STEP 3 Contact arrangement	STEP 4 Contact gender	STEP 5 Insulation rotation	STEP 6 Mod code (max. 3 codes)
Solder Industrial	KPT6	E	20–41	P		– DZ
Crimp Industrial	KPSE6	E	14–12	S	– W	– F42 – A240 – F0

KPTC Examples	STEP 1 Shell style	STEP 2 Class/Backshell	STEP 3 Contact arrangement	STEP 4 Contact gender	STEP 6 Plating	STEP 5 Insulation rotation	STEP 6 Mod code (max. 3 codes)
Solder Industrial	KPTC6	E	20–41	P	C		– MA
Crimp Industrial	KPTC6	PG	14–12	S	– D	W	– P13,5 – MB

Part number creation receptacle

Follow these steps to design your connector part number.

STEP 1 Select shell style (receptacle)

Wall Mount		Cable connecting		Jam Nut*		Box Mount*		Thru-Bulkhead
Solder KPT00 KPTC0	Crimp KPSE00 KPTC0	Solder KPT01 KPTC1	Crimp KPSE01	Solder KPT07 KPTC7	Crimp KPSE07 KPTC7	Solder KPT02 KPTC2	Crimp KPSE02 KPTC2	KPTB (contacts pre-installed)
								

STEP 2 Choose backshell

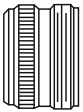
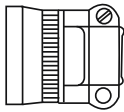
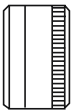
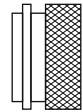
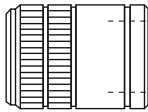
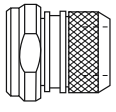
Class A	Class F	Class E	Class E add Mod. code DN	Class PG or ME	Class E add Mod. code DZ
General duty with thread	Grommet seal with strain relief	Environmental, grommet seal, no clamp	Environmental, grommet seal, heat shrink boot adapter	Environmental, KPTC only	Environmental, grommet seal shielded heat shrink boot adapter
					

STEP 3 Choose layout

see page 12–14 for layouts

STEP 4 Choose gender

P=pin S=socket

STEP 5 Choose rotation

see page 15 for rotation (omit for normal position)

STEP 6 Choose modification**

see page 11 for modifications (omit if no modification is required)

* Shell style 02 (box mount) and 07A (jam nut) doesn't accept a backshell

** If a modification is used the initial ,0' in the shell style description is omitted e.g. KPT01 is changed to KPT1. KPTC series does never use the initial ,0' e.g. KPTC6

Design your part number as per above steps

KPSE/KPT Examples	STEP 1 Shell style	STEP 2 Class/Backshell	STEP 3 Contact arrangement	STEP 4 Contact gender	STEP 5 Insulation rotation	STEP 6 Mod code (max. 3 codes)
Solder Industrial	KPT02	E	20–41	P		
Crimp Industrial	KPSE1	E	14–12	S	– W	– F42 – A240 – F0

KPTC Examples	STEP 1 Shell style	STEP 2 Class/Backshell	STEP 3 Contact arrangement	STEP 4 Contact gender	STEP 6 Plating	STEP 5 Insulation rotation	STEP 6 Mod code (max. 3 codes)
Solder Industrial	KPTC2	E	20–41	P	C		– MA
Crimp Industrial	KPTC0	PG	14–12	S	– D	W	– P13,5 – MB

Ordering reference

KPT / KPSE / KPTC

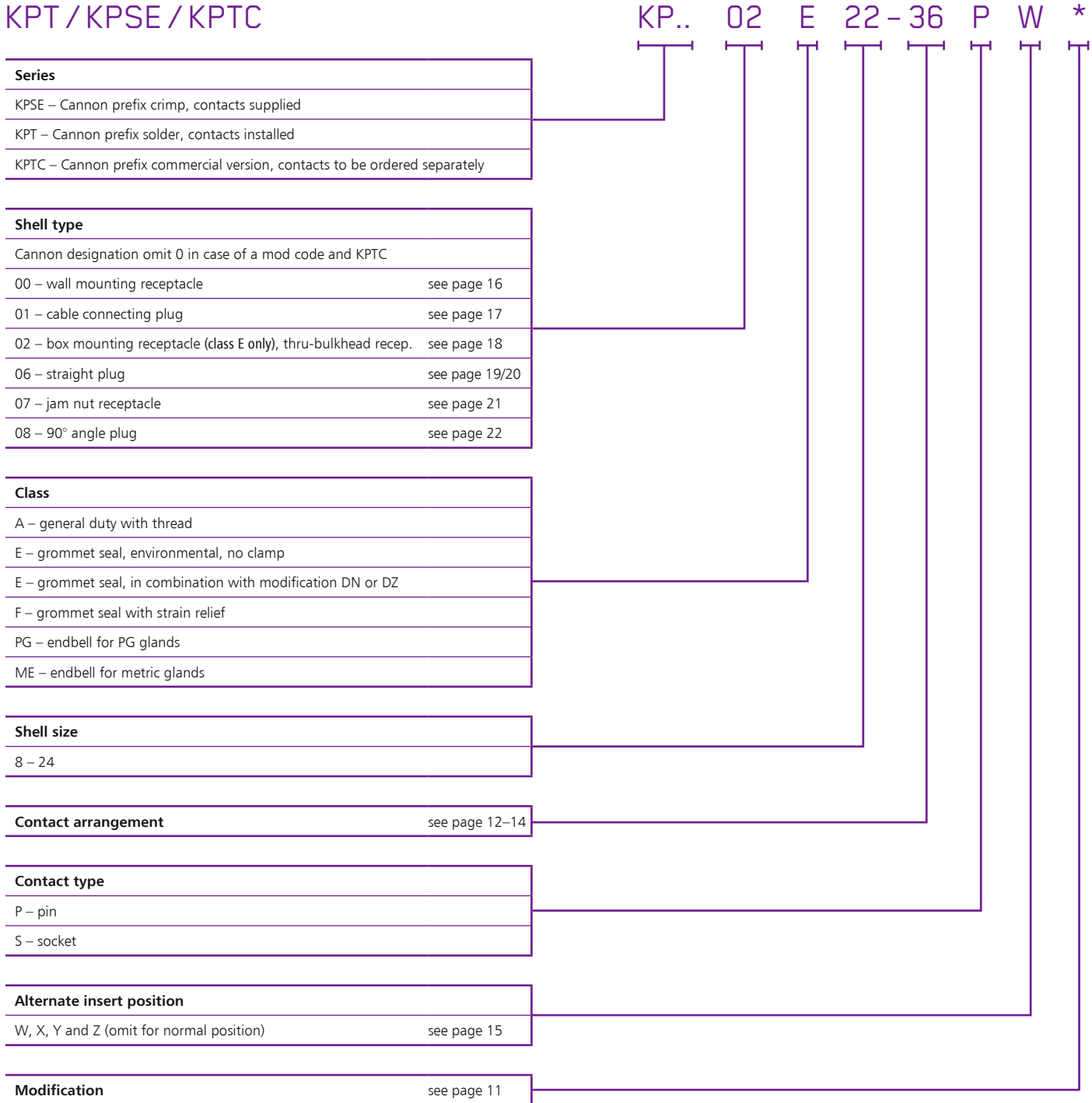

* If a modification is used the initial ,0' in the shell style description is omitted e.g. KPT01 is changed to KPT1. KPTC series does never use the initial ,0' e.g. KPTC6

KPSE/KPT-Modification codes

Multiple codes can be used in order of listing below	KPSE	KPT
Endbell		
DN – heat shrink boot adapter, grommet seal	DN	DN
DZ – shielded, heat shrink boot adapter, grommet seal	DZ	DZ
F42 – without endbell, grommet and ferrule	F42	F42
Plating (Cadmium with olive drab chromate plating is standard; Alternative platings below)		
A232 – Zinc Cobalt, black plating (RoHS compliant)	A232	A232
A240 – Zinc Nickel plating (RoHS compliant) (not for code DZ)	A240	A240
A233 – Zinc Cobalt, green plating	A233	A233
A34 – Nickel plating (RoHS compliant)	A34	A34
Contact		
F0 – connector without contacts	F0	F0
EX – PCB solder pin 0,76x7mm (style 02 and 07 only)	–	EX
EW – PCB solder pin 0,6x7mm (style 02 and 07 only)	–	EW

KPTC-Modification codes

Multiple codes can be used in order of listing below	KPTC
Plating	
Nickel plating (RoHS compliant)	C
Zinc Cobalt black plating (RoHS compliant)	R
Zinc Cobalt green plating (RoHS compliant)	F
Zinc Nickel plating (RoHS compliant) (not for code DZ)	H
Cadmium with olive drab chromate	D
Endbell	
DN – heat shrink boot adapter, grommet seal	DN
DZ – shielded, heat shrink boot adapter, grommet seal	DZ
F42 – without endbell, grommet and ferrule	F42
Endbell for PG glands (KPTC and KPT)	
PG09 - thread for shell size 10	P9
PG11 – thread for shell size 12	P11
PG13,5 – thread for shell size 14	P13,5
PG16 – thread for shell size 16	P16
PG21 – thread for shell size 18, 20, 22	P21
PG29 – thread for shell size 24	P29
Endbell for metric glands (KPTC and KPT)	
M12 – thread for shell size 10	M12
M16 – thread for shell size 12	M16
M20 – thread for shell size 14	M20
M25 – thread for shell size 16, 18, 20	M25
M32 – thread for shell size 22, 24	M32
Contact	
Connector supplied with solder pot contacts installed	MA
Connector supplied with crimp contacts	MB

Military approved version

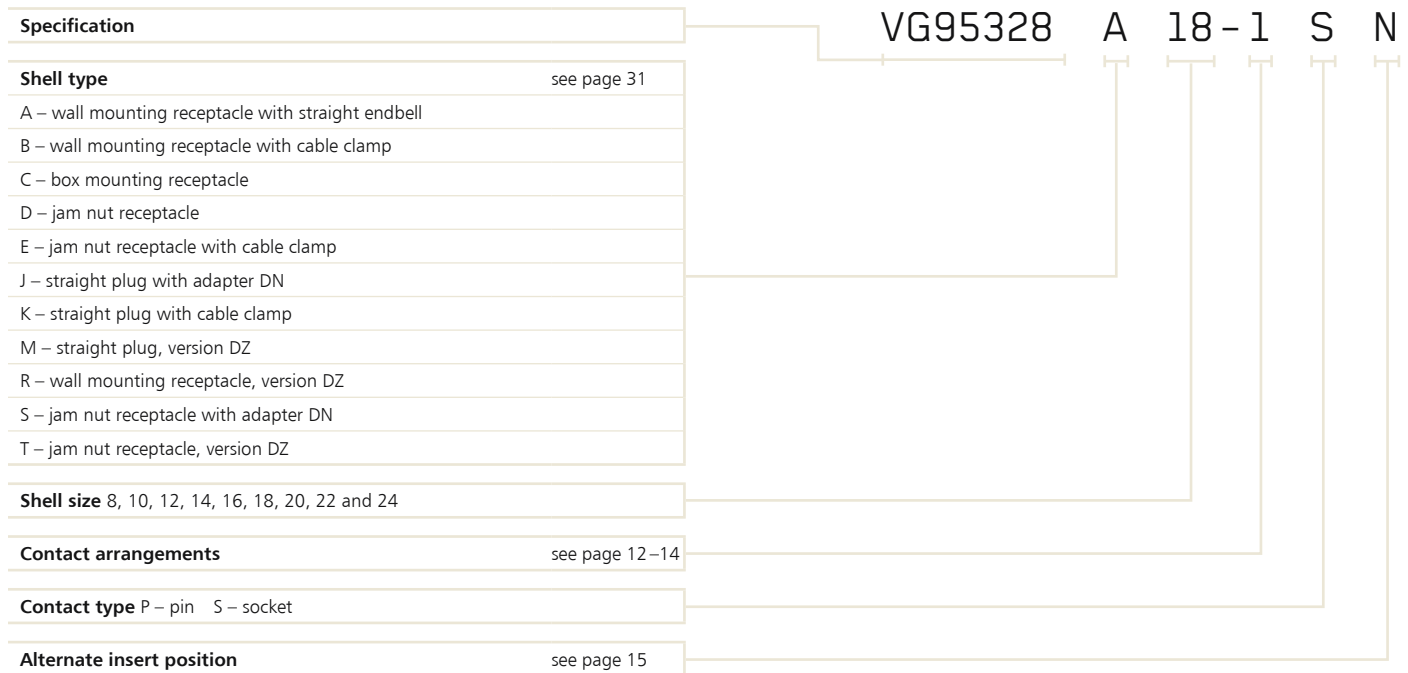

CONTACT ARRANGEMENTS

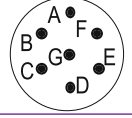
	No. of contacts	Contact arrangements Contact size AWG	Service rating	Insulator position			
				W	X	Y	Z
	2	8-2 ▲▲ 20	1	58	122	-	-
	3	8-3 ▲▲ 20	1	60	210	-	-
	3	8-3A ▲●◇ 20	1	60	-	-	-
	3	8-33 ▲◇△ 20	1	90	-	-	-
	4	8-4 ▲▲ 20	1	45	-	-	-
	6	10-6 ▲●△◇ 20	1	90	-	-	-
	7	10-7 ▲ 20	1	90	-	-	-
	6	10-98 ▲ 20	1	90	180	240	270
	3	12-3 ▲●△◇ 16	2	-	-	180	-
	8	12-8 ▲ 20	1	90	112	203	292
	10	12-10 ▲●△◇ 20	1	60	155	270	295
	14	12-14 ▲ 20	1	60	155	270	295
	5	14-5 ▲●△◇ 16	2	40	92	184	273
	12	14-12 ▲●△◇ 20(8) 16(4)	1	43	90	-	-

Legend ▲KPT ◇KPSE △ authorized per MIL-C-26482 ● authorized per VG95328

CONTACT ARRANGEMENTS

	No. of contacts	Contact arrangements	Service rating	Insulator position			
				W	X	Y	Z
	15	14-15 ▲•△◇ 20 (14) 16(1)	1	17	110	155	234
	18	14-18 ▲ 20	1	15	90	180	270
	19	14-19 ▲•△◇ 20	1	30	165	315	–
	5	14-22 ◇ 12 (4) 20(1)	1	–	–	–	–
	4	14A4 ▲ Coax RG 188 U (not for receptacle shell style 02)	1	–	–	–	–
	8	16-8 ▲•△◇ 16	2	54	152	180	331
	23	16-23 ▲•◇ 20 (22) 16(1)	1	158	270	–	–
	26	16-26 ▲•△◇ 20	1	60	–	275	338
	11	18-11 ▲•△◇ 16	2	62	119	241	340
	32	18-32 ▲•△◇ 20	2	85	138	222	265

Legend ▲KPT ◇KPSE △ authorized per MIL-C-26482 • authorized per VG95328

CONTACT ARRANGEMENTS

	No. of contacts	Contact arrangements Contact size AWG	Service rating	Insulator position			
				W	X	Y	Z
	5	20A6 ◇ 12 Note: contacts are 1 grounding pin and 4 standard size 12 pins	2	90	180	270	–
	16	20-16 ▲•△◇ 16	2	238	316	333	347
	24	20-24 ▲ 20	1	70	145	215	290
	39	20-39 ▲•△◇ 20(37) 16(2)	1	63	114	252	333
	41	20-41 ▲•△◇ 20	1	45	126	225	–
	21	22-21 ▲•△◇ 16	2	16	135	175	349
	36	22-36 ▲• 20	1	72	144	216	288
	41	22-41 ▲△ 20(27) 16(14)	1 2	39	135	264	–
	55	22-55 ▲•△◇ 20	1	30	142	226	314
	61	24-61 ▲•△◇ 20	1	90	180	270	324

Legend ▲KPT ◇KPSE △ authorized per MIL-C-26482 • authorized per VG95328

ALTERNATE INSERT POSITION

The diagram indicates alternate insert positions.

The six positions N, V, W, Y, Z differ in degree of rotation for various sizes and arrangements. For the exact degree of rotation, for the list of contact arrangements and for alternate positions available, refer to the table at the right.

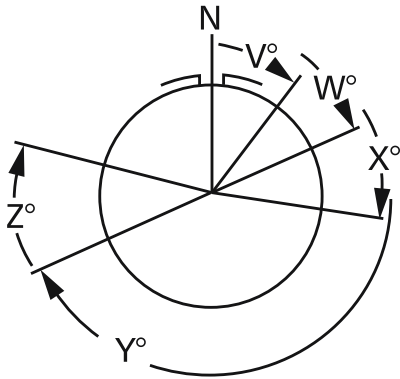

Shell size	No. of contacts	Contact arrangements	Degree of Rotation				
			V	W	X	Y	Z
8	2	8-2	-	58	122	-	-
	3	8-3	-	60	210	-	-
	3	8-3A	-	60	-	-	-
	3	8-33	-	90	-	-	-
	4	8-4	-	45	-	-	-
10	6	10-6	-	90	-	-	-
	7	10-7	-	90	-	-	-
	6	10-98	-	90	180	240	270
12	3	12-3	-	-	-	180	-
	8	12-8	-	90	112	203	292
	10	12-10	-	60	155	270	295
	14	12-14	-	60	155	270	295
14	4	14A4	-	-	-	-	-
	5	14-5	-	40	92	184	273
	12	14-12	-	43	90	-	-
	15	14-15	-	17	110	155	234
	18	14-18	-	15	90	180	270
	19	14-19	-	30	165	315	-
16	5	14-22	-	-	-	-	-
	8	16-8	-	54	52	180	331
	23	16-23	-	158	270	-	-
18	26	16-26	-	60	-	275	338
	11	18-11	-	62	119	241	340
20	32	18-32	-	85	138	222	265
	5	20A6*	-	90	180	270	-
	16	20-16	-	238	318	333	347
	24	20-24	-	70	145	215	290
	39	20-39	-	63	114	252	333
22	41	20-41	-	45	126	225	-
	21	22-21	-	16	135	175	349
	36	22-36	-	72	144	216	288
	41	22-41	-	39	135	264	-
24	55	22-55	-	30	142	226	314
	61	24-61	-	90	180	270	324

* This contact arrangement features five contacts size 12. Four standard contacts and one is a first-to-mate contact.

WALL MOUNTING RECEPTACLES KPT00/KPSE00/KPTC0

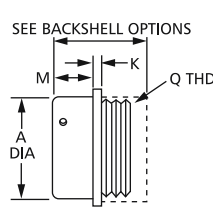

SOLDER
KPT01 (MS3111)

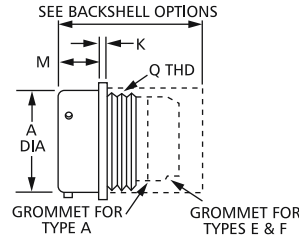

CRIMP
KPSE01 (MS3121)

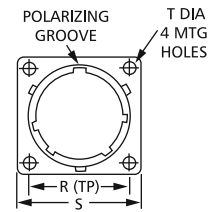

RECEPTACLE ASSEMBLY

Shell size	Ø A	Q	K	M	R	S	Ø T
	+0,03 -0,13	Thread Type 2A	±0,1	±0,15	±0,15	max.	±0,15
8	12,00	7/16-28UNEF	1,9	11,6	15,1	21,0	3,05
10	15,00	9/16-24UNEF	1,9	11,6	18,3	24,2	3,05
12	19,05	11/16-24UNEF	1,9	11,6	20,6	26,6	3,05
14	22,23	13/16-20UNEF	1,9	11,6	23,0	29,0	3,05
16	25,40	15/16-20UNEF	1,9	11,6	24,6	31,3	3,05
18	28,58	1-1/16-18UNEF	1,9	11,6	27,0	33,7	3,05
20	31,75	1-3/16-18UNEF	2,2	14,25	29,4	36,9	3,05
22	34,93	1-5/16-18UNEF	2,2	14,25	31,8	40,1	3,05
24	38,10	1-7/16-18UNEF	2,2	15,1	34,9	43,3	3,75

Backshell options

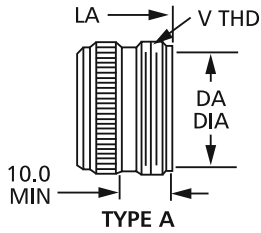

TYPE A

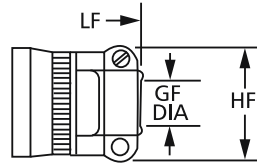

TYPE F

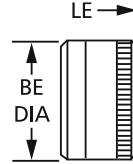

TYPE E

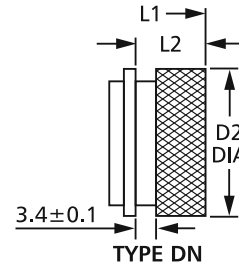

TYPE DN

Shell size	Type A			Type F			Type E	
	Ø Da min.	LA max.	V _{THD} Thread Type 2A	Ø G _F min.	H _F max.	L _F max.	Ø B _E max.	L _E max.
8	8,5	38,0	1/2-28UNEF	2,9	19,3	56,0	14,2	32,5
10	11,8	38,0	5/8-24UNEF	4,5	20,8	56,0	17,2	32,5
12	15,0	38,0	3/4-20UNEF	7,7	24,4	56,0	20,4	32,5
14	17,9	38,0	7/8-20UNEF	9,3	27,2	56,0	23,4	32,5
16	21,1	38,0	1-20UNEF	12,4	28,7	56,0	26,6	32,5
18	24,1	38,0	1-3/16-18UNEF	15,6	35,3	56,0	29,6	32,5
20	26,5	43,1	1-3/16-18UNEF	15,6	35,3	61,0	32,8	34,5
22	30,4	43,1	1-7/16-18UNEF	18,8	39,9	61,0	36,0	34,5
24	32,8	43,1	1-7/16-18UNEF	20,1	43,2	61,0	39,2	34,5

Mod. DN

Shell size	Ø D2	L1	L2
	-0,5	max.	±0,5
8	15,6	35,0	12,2
10	18,4	35,0	12,2
12	23,7	35,0	12,2
14	24,5	35,0	12,2
16	29,8	37,0	14,5
18	32,0	37,0	14,5
20	36,1	42,0	15,8
22	38,5	42,0	15,8
24	41,6	42,0	14,9

CABLE CONNECTING PLUGS KPT01/KPSE01/KPTC1

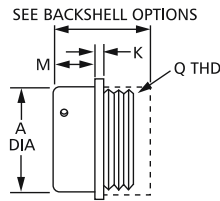

SOLDER
KPT01 (MS3111)

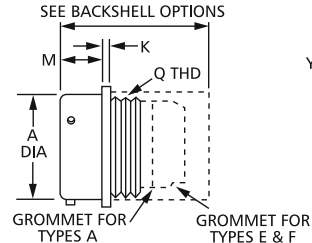

CRIMP
KPSE01 (MS3121)

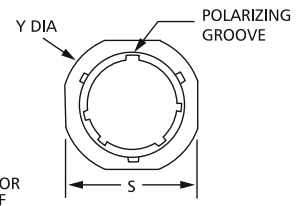

RECEPTACLE
ASSEMBLY

Shell size	Ø A	K	M	Q THD	S	Ø Y
	+0,03 - 0,13	±0,1	±0,15	Thread Type 2A	max.	max.
8	12,00	1,9	11,6	7/16-28UNEF	20,6	23,8
10	15,00	1,9	11,6	9/16-24UNEF	23,8	26,9
12	19,05	1,9	11,6	11/16-24UNEF	26,15	29,3
14	22,23	1,9	11,6	13/16-20UNEF	28,5	31,7
16	25,40	1,9	11,6	15/16-20UNEF	30,7	34,1
18	28,58	1,9	11,6	1-1/16-18UNEF	33,3	36,5
20	31,75	2,2	14,25	1-3/16-18UNEF	36,5	39,6
22	34,93	2,2	14,25	1-5/16-18UNEF	39,5	42,8
24	38,10	2,2	15,1	1-7/16-18UNEF	42,8	46,0

Backshell options

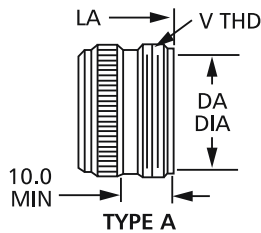

TYPE A

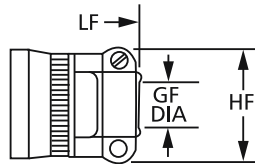

TYPE F

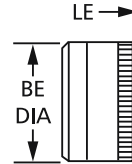

TYPE E

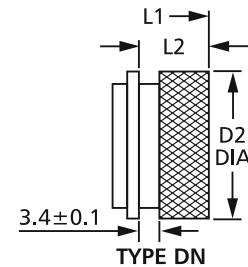

TYPE DN

Shell size	Type A			Type F			Type E	
	Ø D _A min.	L _A max.	V _{THD} Thread Type 2A	Ø G _F min.	H _F max.	L _F max.	Ø B _E max.	L _E max.
8	8,5	38,0	1/2-28UNEF	2,9	19,3	56,0	14,2	32,5
10	11,8	38,0	5/8-24UNEF	4,5	20,8	56,0	17,2	32,5
12	15,0	38,0	3/4-20UNEF	7,7	24,4	56,0	20,4	32,5
14	17,9	38,0	7/8-20UNEF	9,3	27,2	56,0	23,4	32,5
16	21,1	38,0	1-20UNEF	12,4	28,7	56,0	26,6	32,5
18	24,1	38,0	1-3/16-18UNEF	15,6	35,3	56,0	29,6	32,5
20	26,5	43,1	1-3/16-18UNEF	15,6	35,3	61,0	32,8	34,5
22	30,4	43,1	1-7/16-18UNEF	18,8	39,9	61,0	36,0	34,5
24	32,8	43,1	1-7/16-18UNEF	20,1	43,2	61,0	39,2	34,5

Mod. DN

Shell size	Ø D ₂	L ₁	L ₂
	-0,5	max.	±0,5
8	15,6	35,0	12,2
10	18,4	35,0	12,2
12	23,7	35,0	12,2
14	24,5	35,0	12,2
16	29,8	37,0	14,5
18	32,0	37,0	14,5
20	36,1	42,0	15,8
22	38,5	42,0	15,8
24	41,6	42,0	14,9

BOX MOUNTING RECEPTACLE KPT02/KPSE02/KPTC2

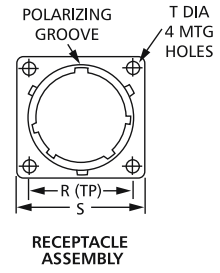
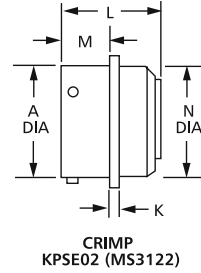
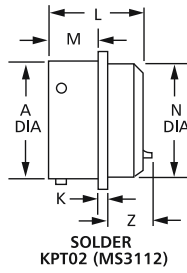

Shell size	KPT/KPSE/KPTC								KPT/KPTC
	Ø A +0,03-0,13	L max.	Ø N max.	K ±0,1	M ±0,15	R ±0,15	S max.	Ø T ±0,15	Z max.
8	12,00	21,1	11,1	1,9	11,6	15,1	21,0	3,05	12,3
10	15,00	21,1	14,3	1,9	11,6	18,3	24,2	3,05	12,3
12	19,05	21,1	17,5	1,9	11,6	20,6	26,6	3,05	12,3
14	22,23	21,1	20,6	1,9	11,6	23,0	29,0	3,05	12,3
16	25,40	21,1	23,8	1,9	11,6	24,6	31,3	3,05	12,3
18	28,58	21,1	27,0	1,9	11,6	27,0	33,7	3,05	12,3
20	31,75	22,7	30,2	2,2	14,25	29,4	36,9	3,05	10,8
22	34,93	22,7	33,4	2,2	14,25	31,8	40,1	3,05	10,8
24	38,10	22,7	36,5	2,2	15,1	34,9	43,3	3,75	10,0

THRU-BULKHEAD RECEPTACLES KPTB

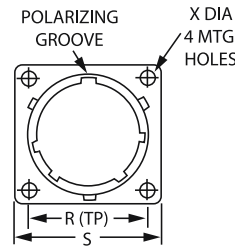
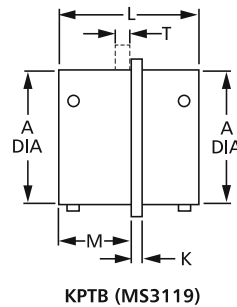

Shell size	Ø A +0,03-0,13	K ±0,1	L max.	M ±0,25	T max.	R ±0,15	S max.	Ø X ±0,15
8	12,00	1,8	28,6	14,5	6,0	15,1	21,0	3,05
10	15,00	1,8	28,6	14,5	6,0	18,3	24,2	3,05
12	19,05	1,8	28,6	14,5	6,0	20,6	26,6	3,05
14	22,23	1,8	28,6	14,5	6,0	23,0	29,0	3,05
16	25,40	1,8	28,6	14,5	6,0	24,6	31,3	3,05
18	28,58	1,8	28,6	14,5	6,0	27,0	33,7	3,05
20	31,75	2,5	31,9	17,7	9,2	29,4	36,9	3,05
22	34,93	2,5	31,9	17,7	9,2	31,8	40,1	3,05
24	38,10	2,5	31,9	17,7	8,0	34,9	43,3	3,75

STRAIGHT PLUGS KPT06/KPSE06/KPTC6

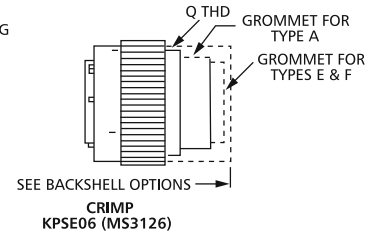
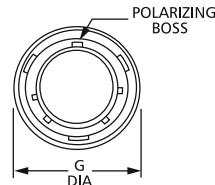
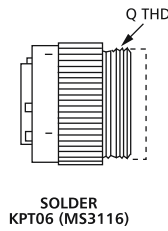

Shell size	Ø G	Q THD
	max.	Thread Type 2A
8	19,8	7/16-28UNEF
10	23,6	9/16-24UNEF
12	26,5	11/16-24UNEF
14	30,1	13/16-20UNEF
16	33,2	15/16-20UNEF
18	35,4	1-1/16-18UNEF
20	39,0	1-3/16-18UNEF
22	42,1	1-5/16-18UNEF
24	45,2	1-7/16-18UNEF

Backshell options

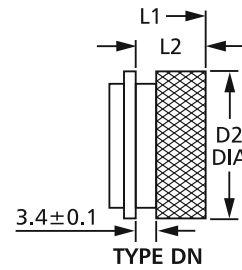
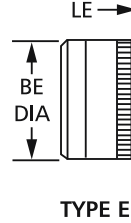
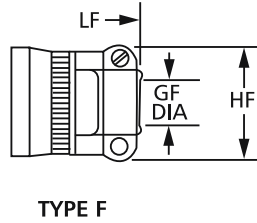
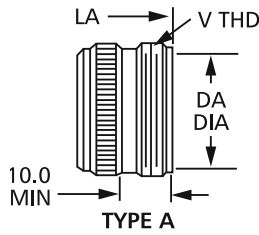

Shell size	Type A			Type F			Type E	
	Ø D _A min.	L _A max.	V _{THD} Thread Type 2A	Ø G _F min.	L _F max.	H _F max.	Ø B _E max.	L _E max.
8	8,5	42,0	1/2-28UNEF	2,9	56,0	19,3	14,2	32,5
10	11,8	42,0	5/8-24UNEF	4,5	56,0	20,8	17,2	32,5
12	15,0	42,0	3/4-20UNEF	7,7	56,0	24,4	20,4	32,5
14	17,9	42,0	7/8-20UNEF	9,3	56,0	27,2	23,4	32,5
16	21,1	42,0	1-20UNEF	12,4	59,0	28,7	26,6	32,5
18	24,1	42,0	1-3/16-18UNEF	15,6	59,0	35,3	29,6	32,5
20	26,5	45,0	1-3/16-18UNEF	15,6	59,0	35,3	32,8	34,5
22	30,4	45,0	1-7/16-18UNEF	18,8	59,0	39,9	36,0	34,5
24	32,8	45,0	1-7/16-18UNEF	20,1	59,0	43,2	39,2	34,5

Mod. DN

Shell size	Ø D ₂	L ₁	L ₂
	-0,5	max.	±0,5
8	15,6	35,0	12,2
10	18,4	35,0	12,2
12	23,7	35,0	12,2
14	24,5	35,0	12,2
16	29,8	37,0	14,5
18	32,0	37,0	14,5
20	36,1	42,0	15,8
22	38,5	42,0	15,8
24	41,6	42,0	14,9

STRAIGHT PLUG KPT6PG/KPTC6PG

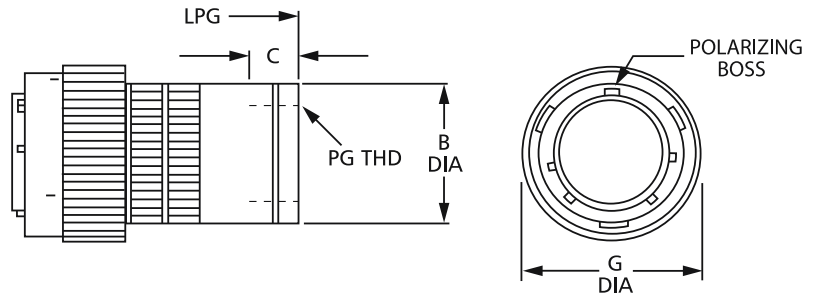

Shell size	Ø G max.	Ø B max.	C min.	LPG max.	PG THD
10	23,6	19,0	10,5	58,5	PG 09
12	26,5	22,5	10,5	58,5	PG 11
14	30,1	25,0	10,5	58,5	PG 13,5
16	33,2	28,0	10,5	73,0	PG 16
18	35,4	32,5	11,5	73,0	PG 21
20	39,0	34,5	11,5	76,0	PG 21
22	42,1	38,0	11,5	82,0	PG 21
24	45,2	40,5	11,5	82,0	PG 29

STRAIGHT PLUG KPT6ME/KPTC6ME

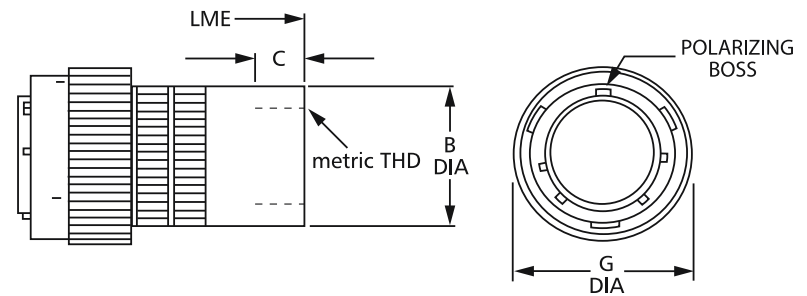

Shell size	Ø G max.	Ø B max.	C min.	LME max.	Metric Thread
10	23,6	19,0	10,5	58,5	M 12x1,5
12	26,5	22,5	10,5	58,5	M 16x1,5
14	30,1	25,0	10,5	58,5	M 20x1,5
16	33,2	28,0	10,5	73,0	M 25x1,5
18	35,4	32,5	11,5	73,0	M 25x1,5
20	39,0	34,5	11,5	76,0	M 25x1,5
22	42,1	38,0	11,5	82,0	M 32x1,5
24	45,2	40,5	11,5	82,0	M 32x1,5

JAM NUT RECEPTACLES KPT07/KPSE07/KPTC7

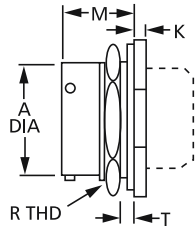

**SOLDER
KPT07 (MS3114)**

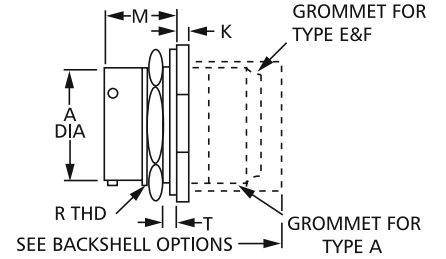
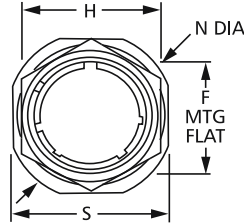

**CRIMP
KPSE07 (MS3124)**

Shell size	Ø A	F	H	K	M	R THD	S	T Panel thickness		Ø N
	+0,03 -0,13	±0,15	±0,15	±0,25	±0,15	Thread Type 2A	±0,5	min.	max.	max.
8	12,00	13,3	19,0	3,2	17,7	9/16-24UNEF	24,0	1,6	3,5	28,0
10	15,00	16,5	22,2	3,2	17,7	11/16-24UNEF	27,0	1,6	3,5	31,0
12	19,05	20,6	27,0	3,2	17,7	7/8-20UNEF	32,0	1,6	3,5	36,0
14	22,23	23,8	30,2	3,2	17,7	1-20UNEF	35,0	1,6	3,5	39,0
16	25,40	26,9	33,3	3,2	17,7	1-1/8-18UNEF	38,5	1,6	3,5	42,0
18	28,58	30,1	36,5	3,2	17,7	1-1/4-18UNEF	41,5	1,6	3,5	45,0
20	31,75	33,3	39,7	4,0	22,5	1-3/8-18UNEF	46,0	1,6	6,5	50,0
22	34,93	36,5	42,9	4,0	22,5	1-1/2-18UNEF	49,5	1,6	6,5	55,0
24	38,10	39,6	46,0	4,0	23,3	1-5/8-18UNEF	52,5	1,6	6,5	57,0

Backshell options

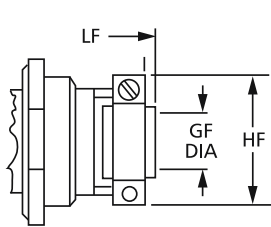

TYPE F

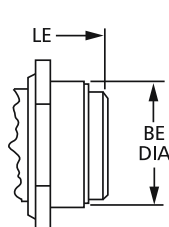

TYPE E

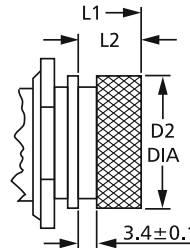

TYPE DN

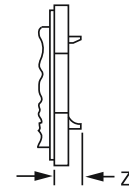

TYPE A

Shell size	Type F			Type E		Type DN			Type A KPT/KPTC
	L _F max.	Ø G _F max.	H _F max.	Ø B _E max.	L _E max.	L ₁ max.	L ₂ ±0,5	Ø D ₂ max.	Z max.
8	44,9	2,9	19,3	18,2	33,5	43,0	12,2	15,6	7,9
10	44,9	4,5	20,8	21,5	33,5	43,0	12,2	18,4	7,9
12	44,9	7,7	24,4	24,6	33,5	43,0	12,2	23,7	7,9
14	44,9	9,3	27,2	27,8	33,5	43,0	12,2	24,7	7,9
16	48,4	12,4	28,7	31,0	33,5	45,5	14,5	29,8	7,9
18	48,4	15,6	35,3	34,1	33,5	45,5	14,5	32,0	7,9
20	50,3	15,6	35,3	38,1	39,0	52,6	15,8	36,1	4,7
22	50,3	18,8	39,9	41,3	39,0	52,6	15,8	28,5	4,7
24	50,3	20,1	43,2	44,5	39,0	51,6	14,9	41,6	3,8

RIGHT ANGLE PLUG, 90° KPT08/KPSE08/KPTC8

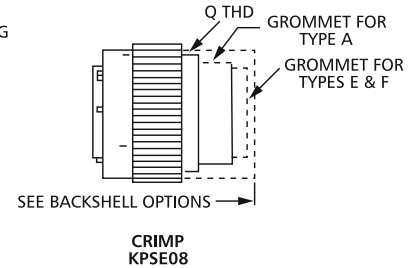
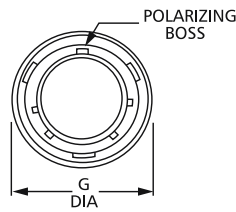
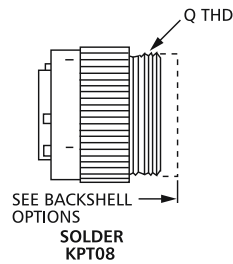

Shell size	Ø G	Q
	max.	Thread Type 2A
8	19,8	7/16-28UNEF
10	23,6	9/16-24UNEF
12	26,5	11/16-24UNEF
14	30,1	13/16-20UNEF
16	33,2	15/16-20UNEF
18	35,4	1-1/16-18UNEF
20	39,0	1-3/16-18UNEF
22	42,1	1-5/16-18UNEF
24	45,2	1-7/16-18UNEF

Backshell options

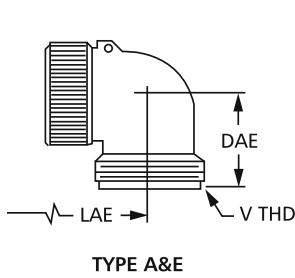

TYPE A & E

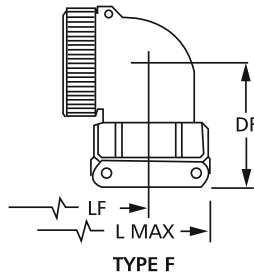

TYPE F

Shell size	Type A and E			Type F		
	L _{AE}	D _{AE}	V _{THD}	L	D _F	L _F
	max.	max.	Thread Type 2A	max.	max.	max.
8	36,1	20,9	1/2-28UNEF	47,0	31,4	36,1
10	38,3	21,7	5/8-24UNEF	49,5	32,2	38,3
12	40,9	23,3	3/4-20UNEF	53,5	35,4	40,9
14	41,6	24,9	7/8-20UNEF	55,5	38,6	41,6
16	42,5	26,5	1-20UNEF	57,0	40,2	42,5
18	44,7	28,1	1-3/16-18UNEF	62,5	41,8	44,7
20	48,3	29,6	1-3/16-18UNEF	67,0	43,4	48,3
22	52,1	31,7	1-7/16-18UNEF	71,5	47,9	52,1
24	52,1	33,6	1-7/16-18UNEF	74,0	49,9	52,1

VERSIONS WITH GROUNDING CONTINUITY KPT/KPSE/KPTC

These connectors are designed to ensure electrical continuity

- at the cable shielding level to protect it against radio frequency interferences
- at the grounding level (if it is connected to the shielding)

The plugs are manufactured with grounding fingers fixed to the front face of the shell. They make contact with the inner side of the receptacle shell. Plug and receptacle feature a special backshell which supports the cable shielding. The connectors are in accordance with the VG95328 specification.

RECEPTACLE WITH GROUNDING CONTINUITY (for shielded cable) KPT0E/KPSE0E/KPTC0E... DZ

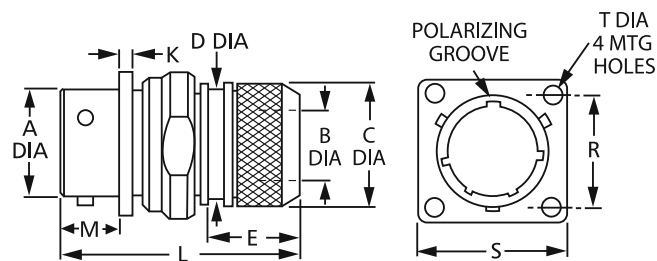

Shell size	Ø A +0,03-0,13	Ø B min.	Ø C ±0,5	Ø D max.	E ±1,0	K ±0,1	L max.	M ±0,15	R ±0,15	S max.	Ø T ±0,15
8	12,00	6,6	16,0	13,3	15,0	1,9	52,0	11,6	15,1	21,0	3,05
10	15,00	9,2	18,0	16,1	15,0	1,9	52,0	11,6	18,3	24,2	3,05
12	19,05	12,2	22,0	20,0	17,0	1,9	52,0	11,6	20,6	26,6	3,05
14	22,23	15,2	25,0	22,2	18,0	1,9	53,0	11,6	23,0	29,0	3,05
16	25,40	18,3	28,0	26,2	18,0	1,9	53,0	11,6	24,6	31,3	3,05
18	28,58	20,0	32,0	28,5	18,0	1,9	53,0	11,6	27,0	33,7	3,05
20	31,75	23,0	34,0	32,5	18,0	2,2	58,0	14,25	29,4	36,9	3,05
22	34,93	26,0	38,0	34,8	18,0	2,2	58,0	14,25	31,7	40,1	3,05
24	38,10	28,8	41,0	37,9	18,0	2,2	58,0	15,1	34,9	43,3	3,75

CABLE CONNECTING PLUG WITH GROUNDING CONTINUITY (for shielded cable) KPT1E/KPSE1E/KPTC1E... DZ

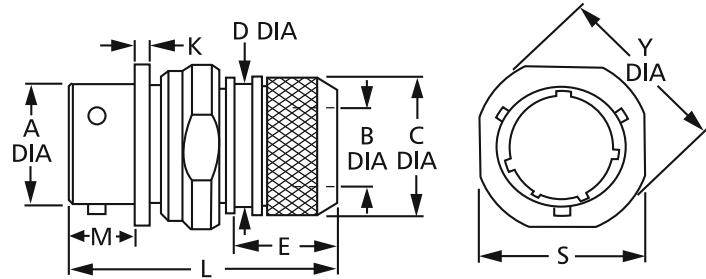

Shell size	Ø A +0,03-0,13	M ±0,15	Ø B min.	Ø C ±0,5	Ø D max.	E ±1,0	K ±0,1	L max.	S max.	Ø Y max.
8	12,00	11,6	6,6	16,0	13,3	15,0	1,9	52,0	18,5	21,0
10	15,00	11,6	9,2	18,0	16,1	15,0	1,9	52,0	23,0	24,2
12	19,05	11,6	12,2	22,0	20,0	17,0	1,9	52,0	29,0	26,6
14	22,23	11,6	15,2	25,0	22,2	18,0	1,9	53,0	29,5	29,0
16	25,40	11,6	18,3	28,0	26,2	18,0	1,9	53,0	32,0	31,3
18	28,58	11,6	20,0	32,0	28,5	18,0	1,9	53,0	35,0	33,7
20	31,75	14,25	23,0	34,0	32,5	18,0	2,2	58,0	38,5	36,9
22	34,93	14,25	26,0	38,0	34,8	18,0	2,2	58,0	42,0	40,1
24	38,10	14,25	28,8	41,0	37,9	18,0	2,2	58,0	46,0	43,3

STRAIGHT PLUG WITH GROUNDING CONTINUITY KPT6E/KPSE6E/KPTC6E... DZ

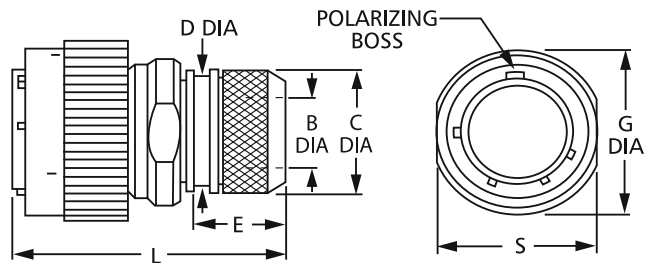

Shell size	Ø B min.	Ø C +0,5	Ø G max.	Ø D max.	E 1,0	L max.	S +0,2
8	6,6	16,0	19,1	13,3	15,0	48,0	17,00
10	9,2	18,0	22,0	16,1	15,0	48,0	19,00
12	12,2	22,0	26,2	20,0	17,0	48,0	23,00
14	15,2	25,0	29,4	22,2	18,0	49,0	26,00
16	18,3	28,0	32,8	26,2	18,0	49,0	29,00
18	20,0	32,0	35,4	28,5	18,0	49,0	33,00
20	23,0	34,0	39,0	32,5	18,0	53,0	35,00
22	26,0	38,0	42,1	34,8	18,0	53,0	39,00
24	28,8	41,0	45,2	37,9	18,0	53,0	42,00

JAM NUT RECEPTACLE WITH GROUNDING CONTINUITY (for shielded cable) KPT7E/KPSE7E/KPTC... DZ

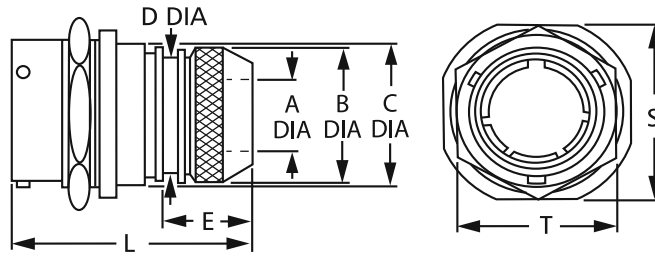

Shell size	Ø A	Ø B	Ø C	Ø D	E	L	S	T
	min.	+0,5	max.	max.	±1,0	max.	±0,25	±0,25
8	6,6	16,0	18,2	13,3	15,0	47,0	23,0	19,0
10	9,2	18,0	21,4	16,1	15,0	47,0	27,0	22,2
12	12,2	22,0	24,6	20,0	17,0	49,0	31,7	27,0
14	15,2	25,0	27,8	22,2	18,0	50,0	34,9	30,2
16	18,3	28,0	30,9	26,2	18,0	50,0	38,1	33,3
18	20,0	32,0	34,1	28,5	18,0	50,0	41,3	36,5
20	23,0	34,0	38,1	32,5	18,0	55,0	46,0	39,7
22	26,0	38,0	41,3	34,8	18,0	55,0	49,2	42,9
24	28,8	41,0	44,4	37,9	18,0	55,0	52,3	46,0

ASSEMBLY OF A CONNECTOR WITH A GROUND CONTINUITY BACKSHELL KPT/KPSE/KPTC... DZ

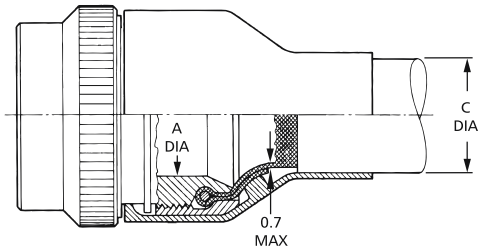

Shell size	ØC
	max.
8	6,6
10	9,2
12	12,2
14	15,2
16	18,3
18	20,0
20	23,0
22	26,0
24	28,8

BOX MOUNTING RECEPTACLE KPT2/KPTC2...EX OR EW

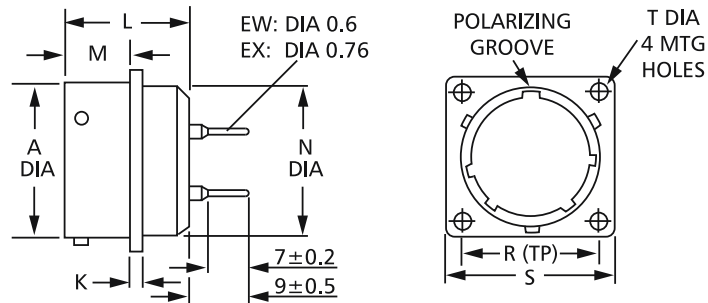

Shell size	Ø A +0,03-0,13	K ±0,1	L max.	M ±0,15	Ø N max.	R ±0,15	S max.	Ø T ±0,15
8	12,00	1,9	21,1	11,60	11,1	15,1	21,0	3,05
10	15,00	1,9	21,1	11,60	14,3	18,3	24,2	3,05
12	19,05	1,9	21,1	11,60	17,5	20,6	26,6	3,05
14	22,23	1,9	21,1	11,60	20,6	23,0	29,0	3,05
16	25,40	1,9	21,1	11,60	23,8	24,6	31,3	3,05
18	28,58	1,9	21,1	11,60	27,0	27,0	33,7	3,05
20	31,75	2,2	22,7	14,25	30,2	29,4	36,9	3,05
22	34,93	2,2	22,7	14,25	33,4	31,7	40,1	3,05
24	38,10	2,2	22,7	15,10	36,5	34,9	43,3	3,75

JAM NUT RECEPTACLES KPT7/KPTC7...EX OR EW

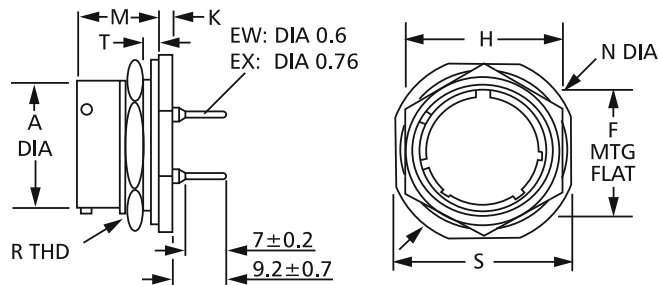

Shell size	Ø A +0,03-0,13	F ±0,15	H ±0,15	K ±0,25	M ±0,15	R _{THD} Thread Type 2A	S ±0,5	T (Panel Thickness)		Ø N max.
								min.	max.	
8	12,0	13,3	19,0	3,2	17,7	9/16-24UNEF	24,0	1,6	3,5	28,0
10	15,0	16,5	22,2	3,2	17,7	11/16-24UNEF	27,0	1,6	3,5	31,0
12	19,1	20,6	27,0	3,2	17,7	7/8-20UNEF	32,0	1,6	3,5	36,0
14	22,2	23,8	30,2	3,2	17,7	1-20UNEF	35,0	1,6	3,5	39,0
16	25,4	26,9	33,3	3,2	17,7	1-1/8-18UNEF	38,5	1,6	3,5	42,0
18	28,6	30,1	36,5	3,2	17,7	1-1/4-18UNEF	41,5	1,6	3,5	45,0
20	31,8	33,3	39,7	4,0	22,5	1-3/8-18UNEF	46,0	1,6	6,5	50,0
22	34,9	36,5	42,9	4,0	22,5	1-1/2-18UNEF	49,5	1,6	6,5	55,0
24	38,1	39,6	46,0	4,0	23,3	1-5/8-18UNEF	52,5	1,6	6,5	57,0

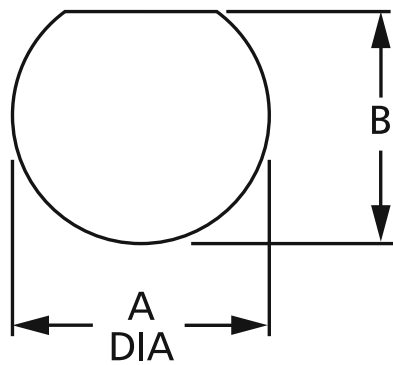
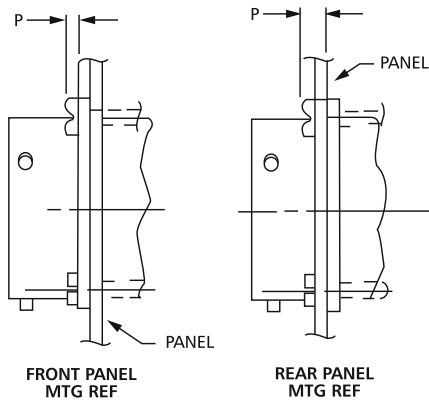
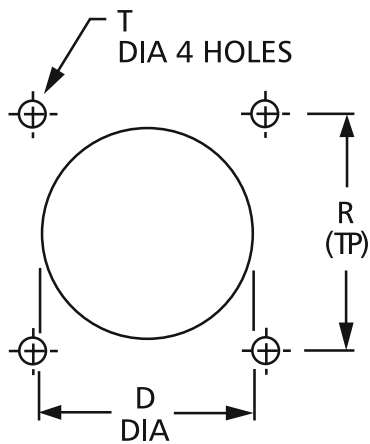

BOX MOUNTING RECEPTACLE

Shell size	For rear mounting	For front mounting		
	$\varnothing D +0,25/0$	$\varnothing D +0,25/0$	$R \pm 0,15$	$\varnothing T +0,3$
8	14,0	12,7	15,1	3,1
10	17,0	16,0	18,3	3,1
12	22,0	19,0	20,6	3,1
14	25,0	22,2	23,0	3,1
16	28,0	25,5	24,6	3,1
18	31,0	28,5	27,0	3,1
20	34,5	31,7	29,4	3,1
22	37,5	35,0	31,8	3,1
24	41,0	38,0	34,9	3,6

PANEL THICKNESS

Shell size	P – Panel thickness
	Height of screw head included
8	2,2
10	2,2
12	2,2
14	2,2
16	2,2
18	2,2
20	5,4
22	5,4
24	5,4

JAM NUT RECEPTACLE

Shell size	KPT/KPSE	KPT/KPSE
	$\varnothing A +0,25/-0$	$B +0/-0,12$
8	14,5	13,6
10	17,7	16,8
12	22,7	20,9
14	25,7	24,1
16	28,8	27,2
18	32,0	30,4
20	35,1	33,6
22	38,4	36,8
24	41,5	40,0

PROTECTIVE CAPS KPT/KPSE/KPTC

Material		Finishes	
Protective cap	Aluminum alloy	A34	Nickel
Sash chain	Stainless steel	A232	Zinc cobalt, black
Cord	Polyamide	A233	Zinc cobalt, green
Ring	Stainless steel	A240	Zinc Nickel plating
Clip	Aluminum alloy	Standard (A66)	Olive drab chromate over cadmium
Gasket	Fluor Silicone		
End link/rivet	Stainless steel, passivated		
Bayonet pin	Stainless steel, passivated		

HOW TO ORDER

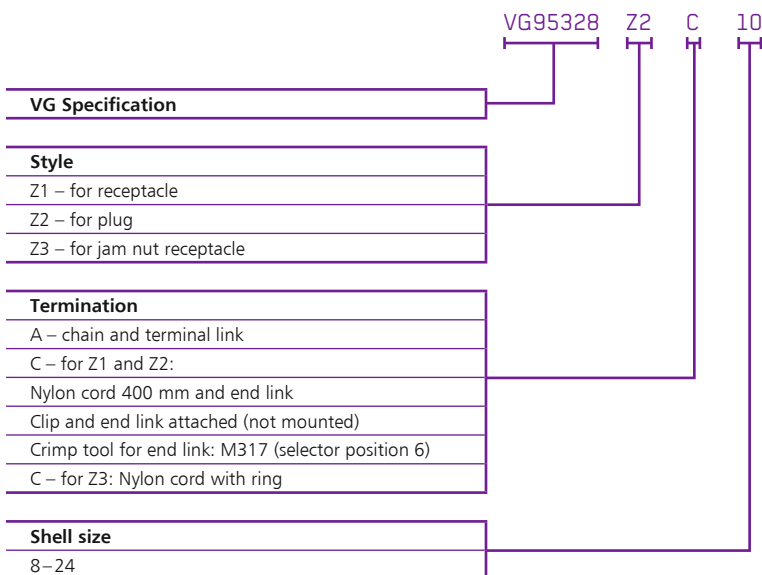
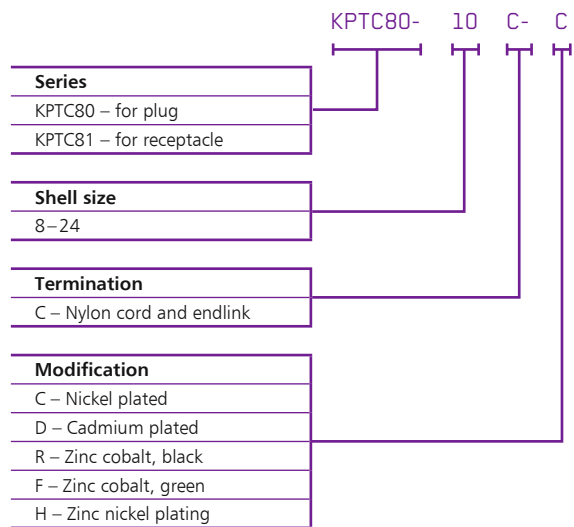
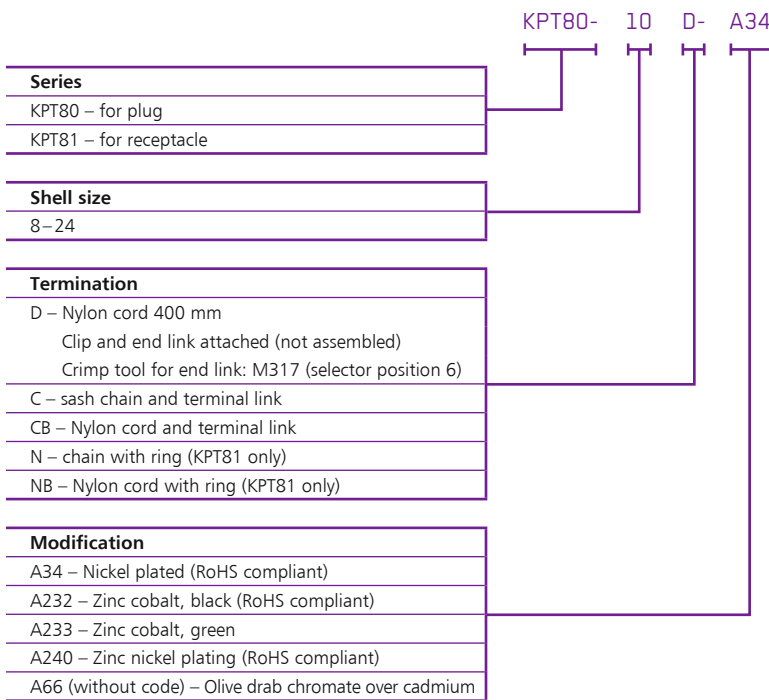

PROTECTIVE CAPS KPT/KPSE/KPTC

Cap with nylon cord

For receptacle
KPT81 termination D
VG95328 Z1 termination C

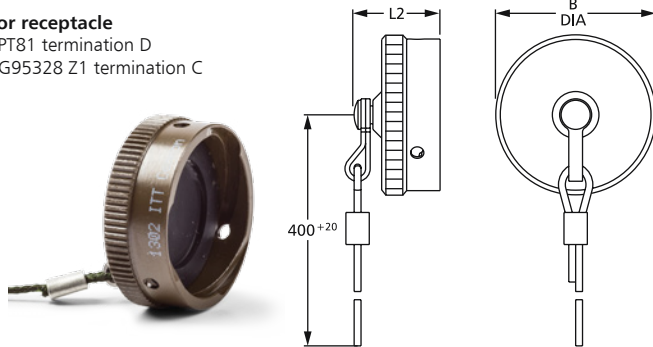

For plug
KPT80 termination D
VG95328 Z2 termination C

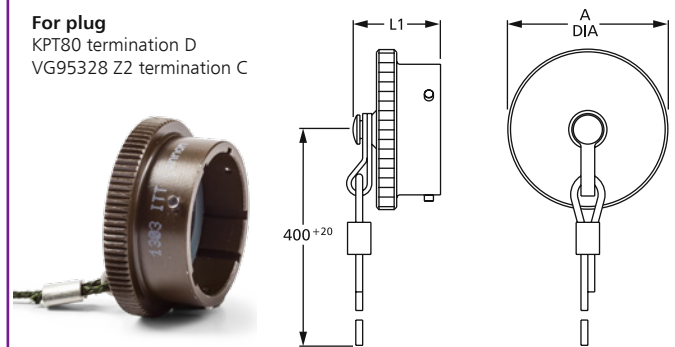

Cap with nylon cord and terminal link

For receptacle
KPT81 termination C and CB
VG95328 Z1 termination A

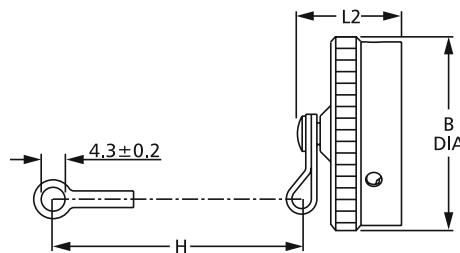

For plug
KPT80 termination C and CB
VG95328 Z2 termination A

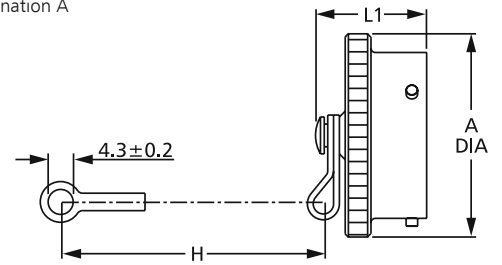

Cap with nylon cord and ring

For receptacle
KPT81 termination N and NB
VG95328 Z3 termination C

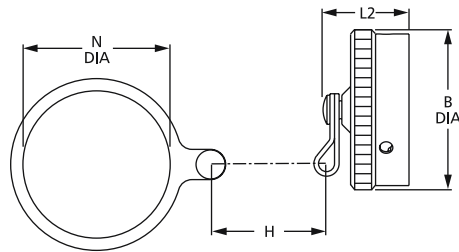

Shell size	Ø A	L ₁	Ø B	L ₂	H	Ø N
	max.	max.	max.	max.	max.	±0,5
8	18,26	19,84	18,0	21,44	76	14,7
10	21,44	19,84	20,3	21,44	76	17,9
12	25,40	19,84	25,1	21,44	89	22,6
14	28,58	19,84	28,2	21,44	89	25,8
16	31,75	19,84	31,5	21,44	89	29,0
18	34,92	19,84	34,5	21,44	89	32,2
20	38,10	21,44	37,8	21,44	101	35,3
22	41,28	21,44	40,9	21,44	101	38,5
24	44,45	22,22	44,2	22,22	101	41,7

HOW TO ORDER

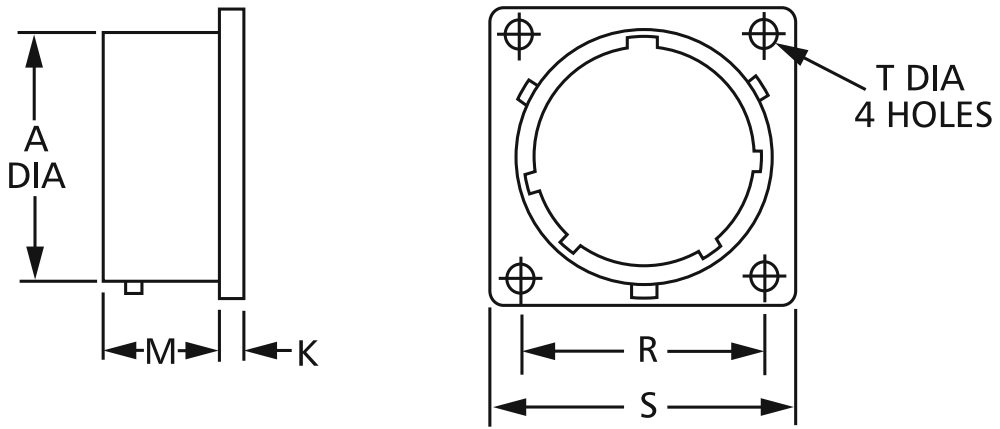
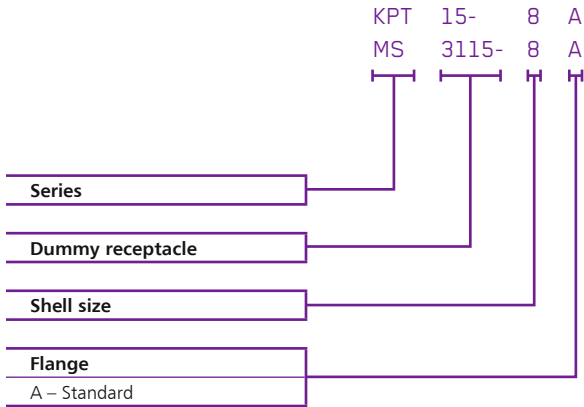

Shell size	Ø A	K	M	R	S	Ø T
	+0,03–0,13	±0,4	±0,15	±0,15	max.	±0,15
*8A	12,00	1,6	12,1	15,1	21,0	3,05
*10A	15,00	1,6	12,1	18,3	24,2	3,05
*12A	19,05	1,6	12,1	20,6	26,6	3,05
*14A	22,23	1,6	12,1	23,0	29,0	3,05
*16A	25,40	1,6	12,1	24,6	31,3	3,05
*18A	28,58	1,6	12,1	27,0	33,7	3,05
*20A	31,75	2,4	14,5	29,4	36,9	3,05
*22A	34,93	2,4	14,5	31,8	40,1	3,05
*24A	38,10	2,4	15,4	34,9	43,3	3,75

* Add "KPT 15 -" or "MS 3115-" prefixes

CROSS REFERENCE LIST KPT/KPSE/VG95328/MIL-C-26482

Solder			Crimp		
ITT Cannon	MIL-C-26482	VG95328	ITT Cannon	MIL-C-26482	VG95328
KPT00E	MS3110E		KPSE00E	MS3120E	VG95328A
KPT00F	MS3110F		KPSE00F	MS3120F	VG95328B
KPT0E-DN			KPSE0E-DN		
KPT0E-DZ			KPSE0E-DZ		VG95328R
KPT01A			KPSE01A		
KPT01E	MS3111E		KPSE01E	MS3121E	
KPT01F	MS3111F		KPSE01F	MS3121F	
KPT1E-DN			KPSE1E-DN		
KPT1E-DZ			KPSE1E-DZ		
KPT02E	MS3112E	VG95328H	KPSE02E	MS3122E	VG95328C
KPT06A			KPSE06A		
KPT06E	MS3116E		KPSE06E	MS3126E	
KPT06F	MS3116F		KPSE06F	MS3126F	VG95328K
KPT6E-DN			KPSE6E-DN		VG95328J
KPT6E-DZ			KPSE6E-DZ		VG95328M
KPT07A			KPSE07A		
KPT07E	MS3114E		KPSE07E	MS3124E	VG95328D
KPT07F	MS3114F		KPSE07F	MS3124F	VG95328E
KPT7E-DN			KPSE7E-DN		VG95328S
KPT7E-DZ			KPSE7E-DZ		VG95328T
KPT08E			KPSE08E		
KPT08F			KPSE08F		
KPTB	MS3119	VG95328P			

CROSS REFERENCE LIST PROTECTIVE CAPS KPT/VG95328/MIL-C-26482

Part No. ITT Cannon	Part No. MIL-C-26482	Part No. VG95328
KPT80	MS3180	
KPT80..C		Z2...VG95328
KPT81	MS3181	
KPT81..C		Z1...VG95328
KPT81..N	MS3181..N	

TOOLS AND ACCESSORIES KPT/KPSE/KPTC

TOOLS



KPSE/KPTC

Tool	Designation	Order reference	Locator*	Order reference	Test gage	Order reference
Hand crimp tool	M22520/1-01	995-0001-585	M22520/1-02	995-0001-736	M22520/3-1	995-0001-684
Crimp machine	WA27F-CE	121586-5067	M22520/1-02	995-0001-736	M22520/3-1	995-0001-684
Crimp machine	HACS	HACS	-	-	-	-

* for contact sizes 20, 16, 12

KPSE

Contact size	Insertion tool	Order reference	Old designation	Extraction tool	Order reference	Extraction TIP
20*	-	038894-0018	CIT-20-16	MS2425R20	995-0001-965	317-7130-000
20**	M24256A20	995-0001-950	CIT-20-5A	MS2425R20	995-0001-965	317-7130-000
16	M24256A16	995-0001-951	CIT-16-1	MS2425R16	995-0001-964	317-7129-000
12	M24256A12	995-0001-913	-	MS2425R12	995-0001-966	317-7131-000

* without insulation support ** with insulation support

KPTC

Contact size	Insertion tool	Order ref.	Insertion pliers	Order ref.	Extraction tool	Extraction TIP
20	CITG-20A	12086-3104	CIT-KPTC-20	121086-3101	CET-KPTC-20	CET-KPTC-20-TIP
16	CIT-16	121086-3008	CIT-F80-16	121086-0097	CET-KPTC-16	CET-KPTC-16-TIP

KPT14A4

Contact type	Insertion tool	Order reference	Old designation	Extraction tool	Order reference	LN
Coaxial	-	-	-	CET-C6B	070064-0000	-

CONTACTS KPT/KPSE/KPTC/ VG95328

KPSE/VG95328

Contact size	Contact type	Contact order reference	
		KPSE version	VG95328 version
20	Socket with insulation support	031-8704-203	031-8704-203
	Pin with insulation support	430-8560-006	430-8560-006
16	Socket	031-8704-000	031-8704-000
	Pin	430-8560-004	430-8560-004
12	Socket	031-8704-012	
	Pin	430-8560-016	
	Grounding pin	430-8560-020	

KPTC

Contact size	Order reference (hard gold plated)
20 Socket	031-8704-508
Pin	430-8560-404
16 Socket	031-8704-502
Pin	430-8560-406

For shell size 8 and contact arrangements 12-14 only:

Contact size	Order reference	
	hard gold plated	hard silver plated
20 Socket	031-8704-509	031-8704-506
20 Pin	430-8560-411	430-8560-410

KPT14A4

Coaxial	Pin	DM 53740-5001
	Socket	DM 53742-5001

WIRE HOLE FILLERS

KPSE/KPTC

KPSE/KPTC

Contact size	Colour code	MS	Cannon
20	Red	MS3187A20	225-1012-000
16	Blue	MS3187-16A	225-1011-000
12*	Yellow	MS3187-12	225-0072-000
Coaxial 14A4*	Yellow	-	225-0018-000

* KPSE only

GASKETS KPT/KPSE/KPTC

KPT/KPSE/KPTC

Shell size	Alu-Flex		Shell size	Chloroprene	
	conductive	non conductive		conductive	non conductive
8	075-8543-000	075-8543-010	18	075-8543-005	075-8543-015
10	075-8543-001	075-8543-011	20	075-8543-006	075-8543-016
12	075-8543-002	075-8543-012	22	075-8543-007	075-8543-017
14	075-8543-003	075-8543-013	24	075-8543-008	075-8543-018
16	075-8543-004	075-8543-014			

KPSE CONTACT AND SEALING PRINCIPLE

- High performance
- Crimp termination
- Closed entry socket contacts

Series KPSE environmental, miniature circular, quick disconnect connectors are designed for the extracting requirements of today's electronic industry.

They are intermateable, intermountable and interchangeable with all connectors manufactured according to MIL-C-26482, VG95328 and HE 301.

Connectors of Cannon series KPSE have obtained the VDE Expertise No. 63761.

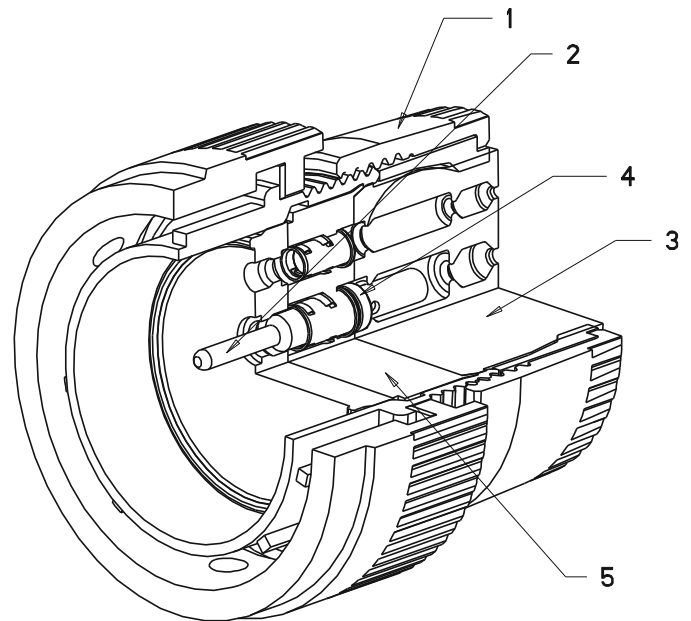

1 Standard MIL-C-26482 or Hardware mates with any connector designed to MIL-C-26482 and VG95328 model

2 Crimp, snap-in contacts are designed to SAE-AS-39029 and can be crimped with the standard M22520/1 crimp tool.

CLOSED-ENTRY SOCKET CONTACTS eliminate damage from abuse by test probes and help to correct any misaligned pins during engagement.

CONTACT INSERTION is accomplished from the rear of the connector. When the contact is fully inserted, the clip tines snap securely behind the contact shoulder.

CONTACT EXTRACTION is accomplished with a front-inserted extraction tool. Pressing the tool plunger pushes the contact out through the rear of the connector.

3 Monobloc insulator does not leave any access to moisture and avoids interfacial empty space.

4 Contact retention
RETAINING CLIP: completely encased in a tough plastic wafer to protect the clip from damage
PLASTIC WAFER: latest version for easier and faster assembly and disassembly of contacts (used on selected layouts)

Complete moisture sealing is achieved by combining four seals: shell, peripheral, interfacial and wire seals.

SHELL SEAL is effected when the plug shell pushes against the sealing ring in the receptacle when the connectors are mated.

PERIPHERAL SEAL around the edge of the pin insulator is designed so that mating the connector puts tension on the seal and greatly reduces compression set.

INTERFACIAL SEAL is achieved by the insulator faces meeting when the plug and receptacle are mated.

WIRE SEAL is accomplished by a multiple ripple design, exceeding the wire sealing requirements of MIL-C-26482.

5 Positive insert-to-shell mechanical retention with hard plastic wafer firmly locked into a groove in the shell, in addition to a strong adhesive bond between the insert and shell.

PRODUCT SAFETY INFORMATION

1. MATERIAL CONTENT AND PHYSICAL FORM

Electrical connectors do not usually contain hazardous materials. They contain conducting and non-conducting materials and can be divided into two groups.

a) Printed circuit types and low cost audio types which employ all plastic insulators and casings.

b) Rugged, Fire Barrier and High Reliability types with metal casings and either natural rubber, synthetic rubber, plastic or glass insulating materials. Contact materials vary with type of connector and also application and are usually manufactured from either: Copper, copper alloys, nickel, alumel, chromel or steel. In special applications, other alloys may be specified.

CAUTION

2. FIRE CHARACTERISTICS AND ELECTRIC SHOCK HAZARD

There is no fire hazard when the connector is correctly wired and used within the specified parameters.

Incorrect wiring or assembly of the connector or careless use of metal tools or conductive fluids, or transit damage to any of the component parts may cause electric shock or burns. Live circuits must not be broken by separating mated connectors as this may cause arcing, ionization and burning. Heat dissipation is greater at maximum resistance in a circuit. Hot spots may occur when resistance is raised locally by damage, e.g. cracked or deformed contacts, broken strands of wire. Local overheating may also result from the use of the incorrect application tools or from poor quality soldering or slack screw terminals. Overheating may occur if the ratings in the product Data Sheet/Catalog are exceeded and can cause breakdown of insulation and hence electric shock. If heating is allowed to continue it intensifies by further increasing the local resistance through loss of temper of spring contacts, formation of oxide film on contacts and wires and leakage currents through carbonization of insulation and tracking paths. Fire can then result in the presence of combustible materials and this may release noxious fumes. Overheating may not be visually apparent. Burns may result from touching overheated components.

3. HANDLING

Care must be taken to avoid damage to any component parts of electrical connectors during installation and use. Although there are normally no sharp edges, care must be taken when handling certain components to avoid injury to fingers.

Electrical connectors may be damaged in transit to the customers, and damage may result in creation of hazards. Products should therefore be examined prior to installation/use and rejected if found to be damaged.

4. DISPOSAL

Incineration of certain materials may release noxious or even toxic fumes.

5. APPLICATION

Connectors with exposed contacts should not be selected for use on the current supply side of an electrical circuit, because an electric shock could result from touching exposed contacts on an unmated connector. Voltages in excess of 30V ac or 42.5V DC are potentially hazardous and care should be taken to ensure that such voltages cannot be transmitted in any way to exposed metal parts of the connector body. The connector and wiring should be checked, before making live, to have no damage to metal parts or insulators, no solder blobs, loose strands, conducting lubricants, swarf, or any other undesired conducting particles. Circuit resistance and continuity check should be made to make certain that there are no high resistance joints or spurious conducting paths. Always use the correct application tools as specified in the Data Sheet/Catalog. Do not permit untrained personnel to wire, assemble or tamper with connectors. For operation voltage please see appropriate national regulations.

IMPORTANT GENERAL INFORMATION

(i) **Air and creepage paths/Operating voltage.** The admissible operating voltages depend on the individual applications and the valid national and other applicable safety regulations. For this reason the air and creepage path data are only reference values. Observe reduction of air and creepage paths due to PC board and/or harnessing.

(ii) Temperature

All information given are temperature limits. The operation temperature depends on the individual application.

(iii) Other important information

Cannon continuously endeavors to improve their products. Therefore, Cannon products may deviate from the description, technical data and shape as shown in this catalog and data sheets.

ITT's Interconnect Solutions, is a division of ITT Corporation who manufactures the highest quality products available in the marketplace; however these products are

intended to be used in accordance with the specifications in this publication. Any use or application that deviates from the stated operating specifications is not recommended and may be unsafe. No information and data contained in this publication shall be construed to create any liability on the part of Cannon. Any new issue of this publication shall automatically invalidate and supersede any and all previous issues.

Product Warranty

A limited warranty applies to Cannon products. In general, except for obligations assumed by Cannon under this warranty, Cannon shall not be liable for any loss, damage, cost of repairs, incidental or consequential damages of any kind, whether or not based on express or implied warranty, contract, negligence or strict liability arising in connection with the design, manufacture, sale, use or repair of the products. Product availability, prices and delivery dates are exclusively subject to our respective order confirmation form; the same applies to orders based on development samples delivered. Please refer to www.ittcannon.com (General Terms of Sale) for the complete text of Cannon's applicable Terms and Conditions, including Warranty.

This publication is not to be construed as an offer. It is intended merely as an invitation to make an offer. By this publication, Cannon does not assume responsibility or any liability for any patent infringements or other rights of third parties which may result from its use.

Reprinting this publication is generally permitted, indicating the source. However, Cannon's prior consent must be obtained in all cases. "Engineered for life" is a registered trademark of ITT Corporation ©2012. All other trademarks or registered trademarks are property of their respective owners. All data subject to change without notice.

This document does not contain technical data whose export is restricted by the Arms Export Control Act (Title 22, U.S.C., App 2401 et. Seq.)



Circular/Filter/Hermetic/Fiber Optic Connectors

As a world leader in circular, filter, and hermetic connectors, ITT can leverage its design and manufacturing expertise to fit virtually any application. Our expertise includes fast positive mating for a wide range of military applications, as well as numerous sizes and contact configurations for various harsh environments. Our wide variety of fiber optic products include hybrid contacts, multi-channel, rack and panel, and hi-rel assemblies, including MIL and ARINC standard solutions that meet numerous specifications, including NATO and MIL standards.



D-Subminiature Connectors

Cannon invented D-sub connectors in 1952. Our family of D-Subs now includes combinations of signal, power and RF, as well as severe service sealed connectors. Cannon D-Subs are available with an extensive line of backshells and accessories and are one of the most economical shielded connector solutions available. ITT D-Sub connectors are qualified to the MIL-DTL-24308 specification.



Microminiature Connectors

Developed first by Cannon in the 1960's, ITT's Interconnect Solutions microminiature connectors offer high performance and reliability with exceptional versatility. Available in rectangular, circular, and strip configurations for countless applications, many of our connectors meet or exceed applicable requirements of the MIL-DTL-83513 specification.



Rack and Panel Connectors

Initially pioneered by Cannon during the 1930s, ITT's Interconnect Solutions is the world leader in rack and panel connectors, offering unmatched variety of shell configurations and insert arrangements, materials, plating, and contact options. Many of our standard and custom designs meet the stringent requirements of ARINC 600, ARINC 404 (MIL-C-81659), and MIL-DTL-83733 standards.



Trident

Cannon's Trident Connector System is a versatile range of electrical connectors based on a standard contact design. These contacts are fully interchangeable throughout the Trident Connector System. The connector options include low cost rectangular, rack and panel, industrial grade circulars, harsh environment circulars and shielded circulars.



Transportation

The ITT's Interconnect Solutions includes sealed circular and rectangular connectors in metal or plastic shells. These configurations include board to cable or cable to cable/bulkhead applications. Both signal and power contacts can be combined in various layouts. All product lines within the Transportation segment offer very low contact resistance providing maximum signal integrity.



ITT's Interconnect Solutions is an international manufacturer and supplier of connectors including circular, rectangular, fiber optic, RF, power and high voltage, audio, PMCIA, Compact Flash Card, enclosures, cable assemblies, and application specific custom solutions. The Interconnect Solutions portfolio includes the brands Cannon, VEAM, and BIW Connector Systems. As a worldwide leader in connector technology for nearly a century, ITT offers one of the broadest product offerings, six sigma manufacturing capability, Value Based Product Development with exceptional engineering capability, and an extensive sales, distribution, and customer support network.



ITT Interconnect Solutions
Cannon, VEAM,
BIW Connector Systems

Visit our website at
www.ittcannon.com



Global Design & Manufacturing

Customer Support

North America

MEXICO – Cannon, VEAM
Av. Libre Comercio s/n-
entre Calzada Industrial
Nuevo Nogales y Calzada del Raquet Club,
Parque Industrial Nuevo Nogales
phone: +52.631.3110050
fax: +52.631.3110060

USA – Cannon
666 East Dyer Road
Santa Ana, CA 92705
toll free: +1.800.854.3028
phone: +1.714.557.4700
fax: +1.714.628.2142

USA – BIW Connector Systems
500 Tesconi Circle
Santa Rosa, CA 95401
phone: +1.707.523.2300
fax: +1.707.523.3567

USA - VEAM
100 New Wood Road
Watertown, CT 06795
phone: +1.860.274.9681
fax: +1.860.274.4963

Europe & Middle East

FRANCE – Cannon, VEAM
15, Boulevard Robert Thiboust
Serris, France 77700
phone: +33.1.60.04.93.93
fax: +33.1.60.04.93.90

GERMANY – Cannon, VEAM
Cannonstrasse 1
71384 Weinstadt
phone: +49.7151.699.0
fax: +49.7151.699.217

ITALY – VEAM
Corso Europa 41/43
Lainate (MI), Italy 20020
phone: +39.02938721
fax: +39.0293872300

LEBANON – BIW Connector Systems
P.O. Box 199
Jounieh
Lebanon
phone: +961.9.911.560
fax: +961.9.912.126

UK – Cannon, VEAM
Jays Close, Viabes Estate
Basingstoke, RG22 4BA
phone: +44.1256.311200
fax: +44.1256.323356

Asia

CHINA – Cannon, VEAM
Tuopandun Industrial Area,
Jinda Cheng, Xiner Village, Shajing Town,
Boan District, Shenzhen City,
Guangdong Province, China 518125
phone: +86.755.2726.7238
fax: +86.755.2726.7515

HONG KONG – Cannon, VEAM
Units 2405-6, 24/F, ING Tower
308 Des Voeux Road Central
Hong Kong
phone: +852.2732.2720
fax: +852.2732.2919

INDIA – Cannon, VEAM
ITT Corporation India Pvt Ltd
Money Chamber, Unit No. 202
#6, KH Road, Bangalore
560027
phone: +91 22 67843000
fax: +91 22 26783033

JAPAN – Cannon, VEAM
5-11-3, Hibarigaoka,
Zama-shi, Kanagawa, Japan 252-0003
phone: +81.462.57.2010
fax: +81.462.57.1680

SINGAPORE – Cannon, VEAM
10 Jalan Kilang #06-01
Singapore 159410
phone: +65.62763693 ext 232
fax: +65.62763685



ITT

ENGINEERED FOR LIFE

© 2013 ITT Corporation "Engineered for life" and "Cannon" are registered trademarks of ITT Corporation. Specification and other data are based on information available at the time of printing, and are subject to change without notice.