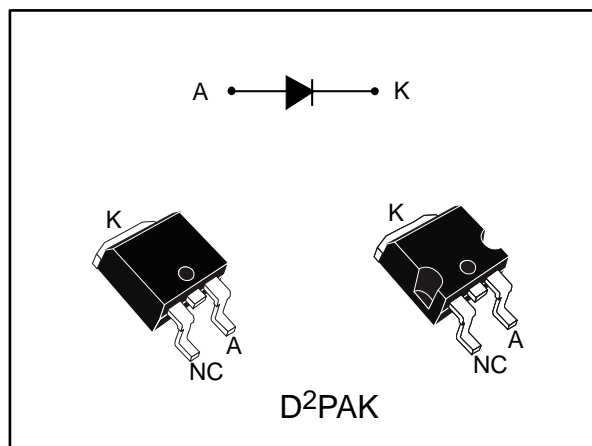

## High efficiency rectifier

Datasheet - production data

**Features**

- Ultrafast recovery
- Low power losses
- High surge capability
- Low leakage current
- High junction temperature
- ECOPACK®2 compliant component for D2PAK on demand

**Description**

The device is an ultrafast recovery power rectifier dedicated to energy recovery in PDP application.

It is especially designed for clamping function in energy recovery block.

The compromise between forward voltage drop and recovery time offers optimized performance.

**Table 1: Device summary**

Symbol	Value
$I_{F(\text{peak})}$	10 A
$V_{RRM}$	400 V
$T_j (\text{max})$	175 °C
$V_F (\text{typ})$	1.15 V
$t_{rr} (\text{typ.})$	15 ns

# 1 Characteristics

**Table 2: Absolute ratings (limiting values, at 25 °C, unless otherwise specified)**

Symbol	Parameter		Value	Unit
$V_{RRM}$	Repetitive peak reverse voltage		400	V
$I_{F(RMS)}$	Forward rms current		20	A
$I_{F(peak)}$	Peak working forward current	$T_C = 135\text{ °C}$ $\delta = 0.5$ square wave	10	A
$I_{FSM}$	Surge non repetitive forward current	$t_p = 10$ ms sinusoidal	100	A
$T_{stg}$	Storage temperature range		-65 to +175	°C
$T_j$	Maximum operating junction temperature		175	°C

**Table 3: Thermal parameter**

Symbol	Parameter	Max. value	Unit
$R_{th(j-c)}$	Junction to case	3.5	°C/W

**Table 4: Static electrical characteristics**

Symbol	Parameter	Test conditions		Min.	Typ.	Max.	Unit
$I_R^{(1)}$	Reverse leakage current	$T_j = 25\text{ °C}$	$V_R = V_{RRM}$	-		10	$\mu\text{A}$
		$T_j = 125\text{ °C}$		-	10	100	
$V_F^{(2)}$	Forward voltage drop	$T_j = 25\text{ °C}$	$I_F = 10\text{ A}$	-	1.50	1.70	V
		$T_j = 125\text{ °C}$		-	1.15	1.35	

**Notes:**

(1)Pulse test:  $t_p = 5\text{ ms}$ ,  $\delta < 2\%$

(2)Pulse test:  $t_p = 380\text{ }\mu\text{s}$ ,  $\delta < 2\%$

To evaluate the conduction losses, use the following equation:

$$P = 1.05 \times I_{F(AV)} + 0.03 \times I_{F(RMS)}^2$$

Table 5: Dynamic electrical characteristics

Symbol	Parameter	Test conditions		Min.	Typ.	Max.	Unit
$t_{rr}$	Reverse recovery time	$T_j = 25\text{ °C}$	$I_F = 0.5\text{ A}$ , $I_{rr} = 0.25\text{ A}$ , $I_R = 1\text{ A}$	-	15	20	ns
			$I_F = 1\text{ A}$ , $V_R = 30\text{ V}$ , $di_F/dt = -50\text{ A}/\mu\text{s}$	-		40	
$t_{fr}$	Forward recovery time	$T_j = 25\text{ °C}$	$I_F = 10\text{ A}$ , $di_F/dt = 100\text{ A}/\mu\text{s}$ $V_{FR} = 1.1 \times V_{Fmax}$	-		140	ns
$V_{FP}$	Forward recovery voltage	$T_j = 25\text{ °C}$	$I_F = 10\text{ A}$ , $di_F/dt = 100\text{ A}/\mu\text{s}$	-		3	V
$I_{RM}$	Reverse recovery current	$T_j = 125\text{ °C}$	$I_F = 10\text{ A}$ , $V_R = 200\text{ V}$ $di_F/dt = 200\text{ A}/\mu\text{s}$	-	6.2	8.0	A
$S_{factor}$	Softness factor			-	0.3		-

### 1.1 Characteristics (curves)

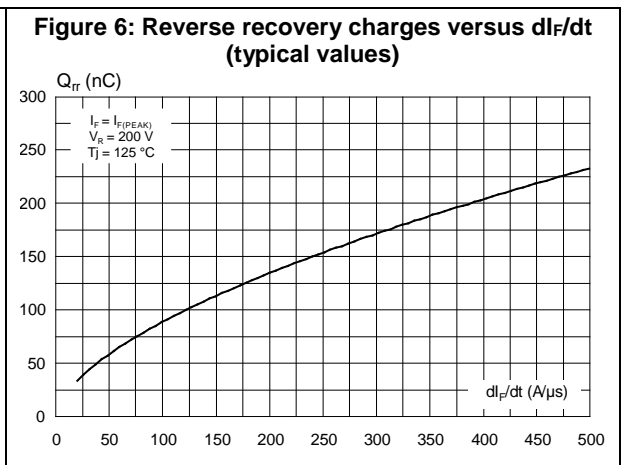
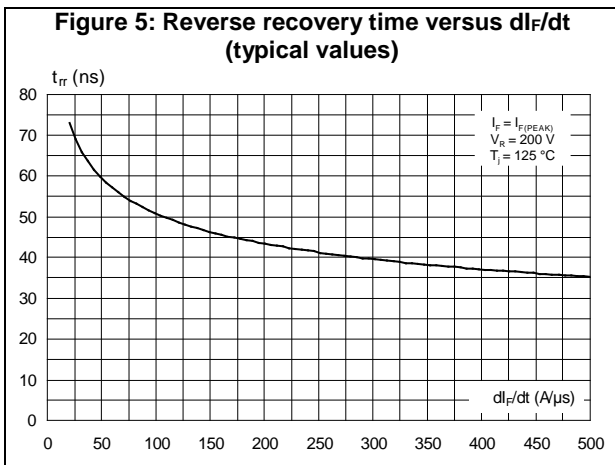
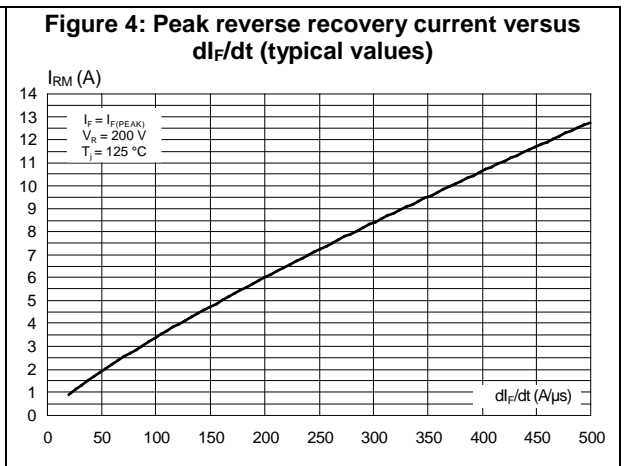
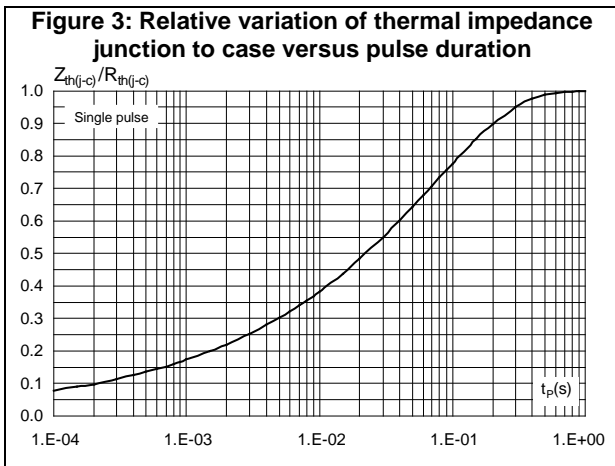
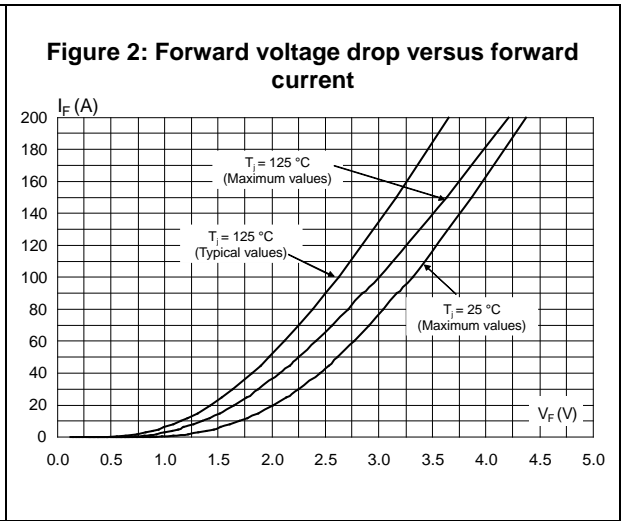
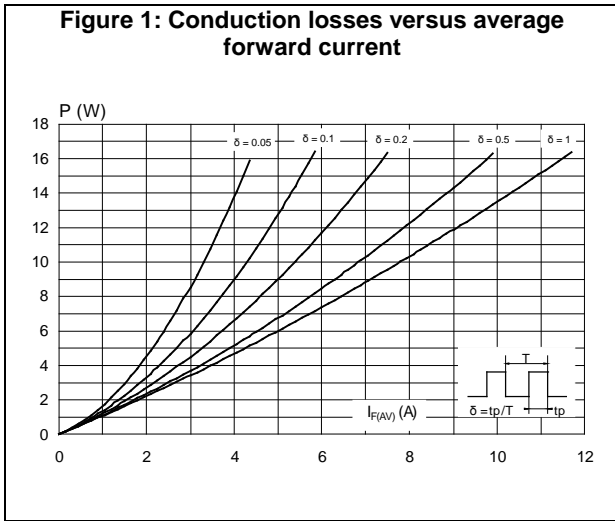

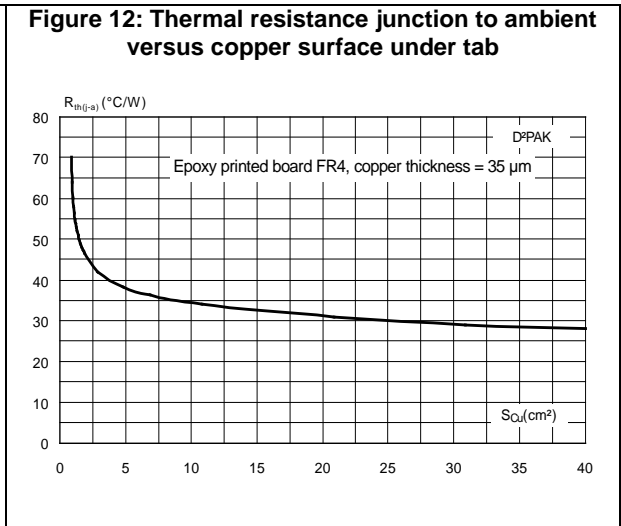
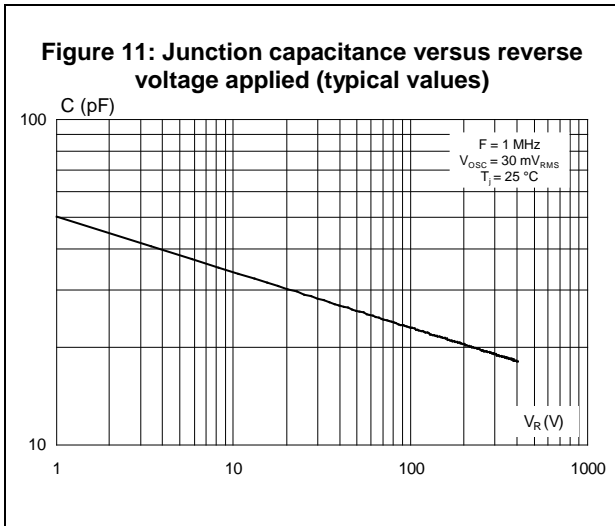
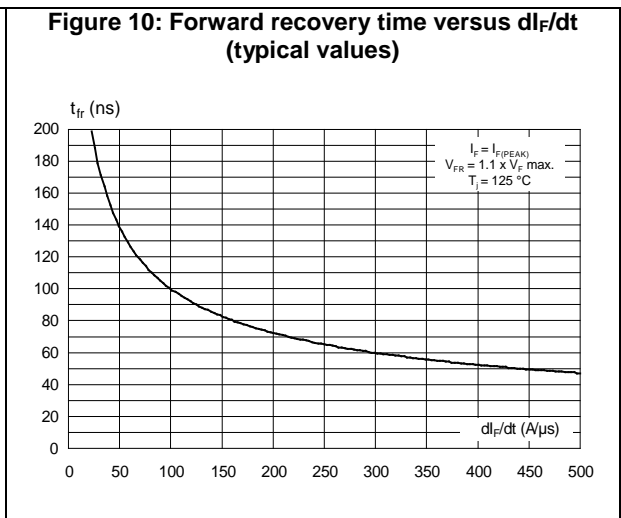
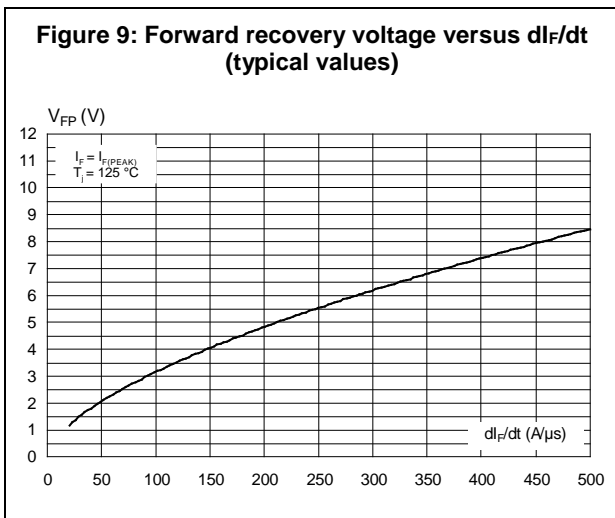
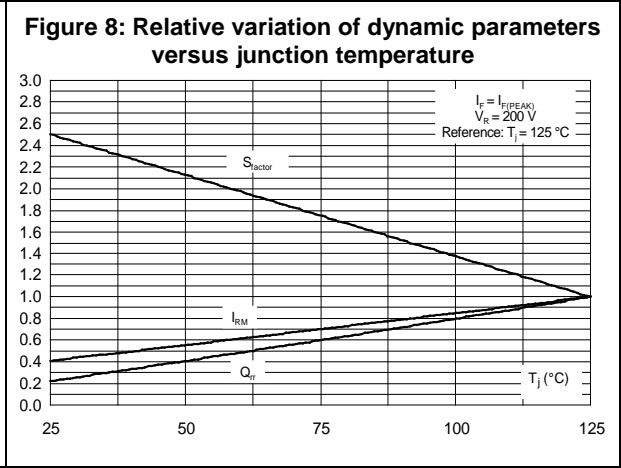
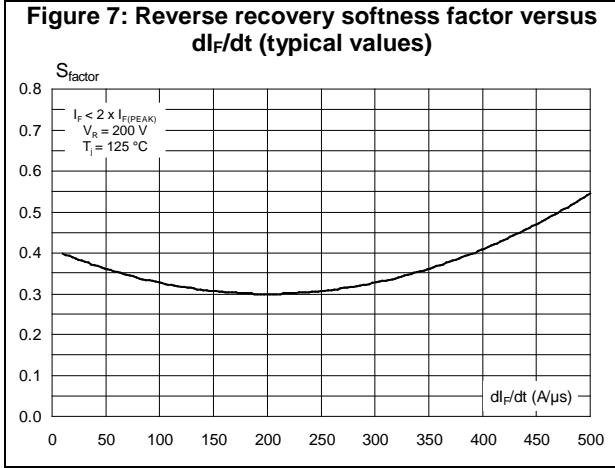

## 2 Package information

In order to meet environmental requirements, ST offers these devices in different grades of ECOPACK® packages, depending on their level of environmental compliance. ECOPACK® specifications, grade definitions and product status are available at: [www.st.com](http://www.st.com). ECOPACK® is an ST trademark.

- Cooling method: by conduction (C)
- Epoxy meets UL94,V0

## 2.1 D<sup>2</sup>PAK package information

Figure 13: D<sup>2</sup>PAK package outline

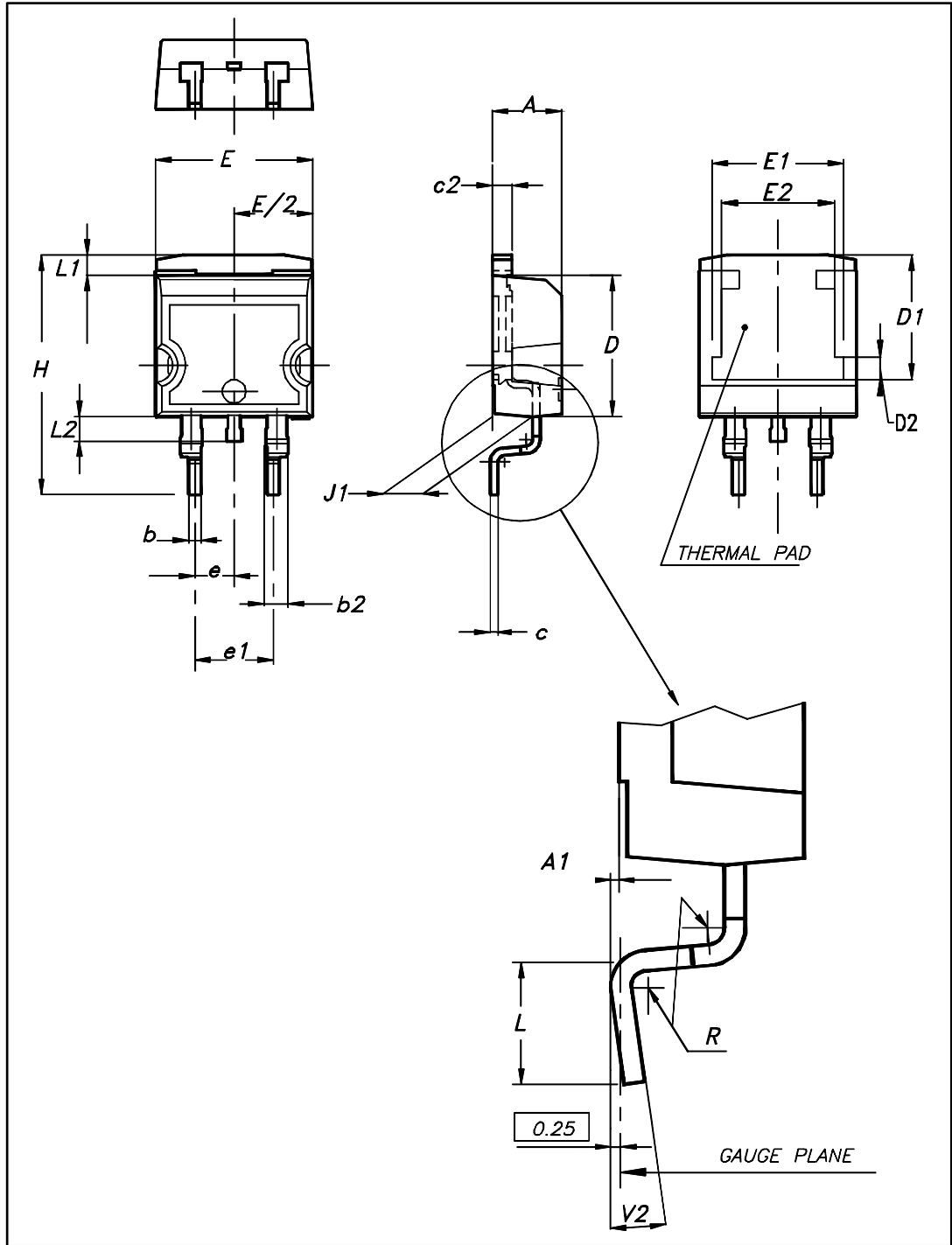

This package drawing may slightly differ from the physical package. However, all the specified dimensions are guaranteed.

Table 6: D<sup>2</sup>PAK package mechanical data

Ref.	Dimensions			
	Millimeters		Inches	
	Min.	Max.	Min.	Max.
A	4.36	4.60	0.172	0.181
A1	0.00	0.25	0.000	0.010
b	0.70	0.93	0.028	0.037
b2	1.14	1.70	0.045	0.067
c	0.38	0.69	0.015	0.027
c2	1.19	1.36	0.047	0.053
D	8.60	9.35	0.339	0.368
D1	6.90	8.00	0.272	0.311
D2	1.10	1.50	0.043	0.060
E	10.00	10.55	0.394	0.415
E1	8.10	8.90	0.319	0.346
E2	6.85	7.25	0.266	0.282
e	2.54 typ.		0.100	
e1	4.88	5.28	0.190	0.205
H	15.00	15.85	0.591	0.624
J1	2.49	2.90	0.097	0.112
L	1.90	2.79	0.075	0.110
L1	1.27	1.65	0.049	0.065
L2	1.30	1.78	0.050	0.070
R	0.4 typ.		0.015	
V2	0°	8°	0°	8°



Figure 14: D<sup>2</sup>PAK recommended footprint (dimensions in mm)

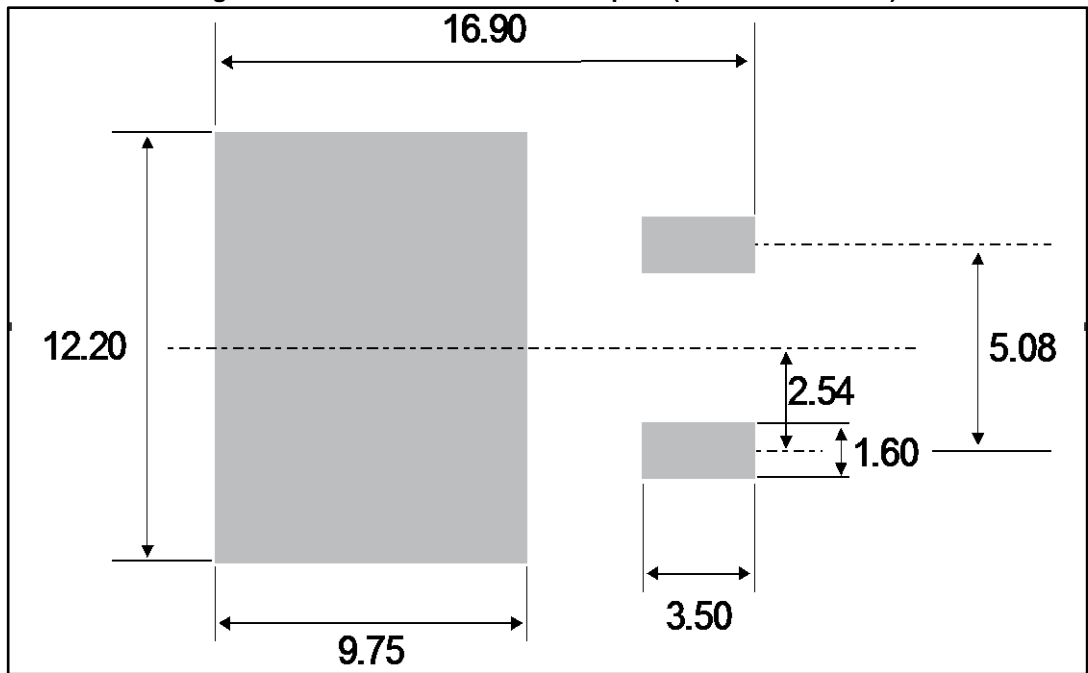

### 3 Ordering information

Table 7: Ordering information

Order code	Marking	Package	Weight	Base qty.	Delivery mode
STTH10R04G-TR	STTH10R04G	D <sup>2</sup> PAK	1.38 g	1000	Tape and reel

### 4 Revision history

Table 8: Document revision history

Date	Revision	Changes
07-Nov-2007	1	First issue.
08-Aug-2017	2	Updated features and package silhouette. Minor text changes to improve readability. Updated <a href="#">Section 1: "Characteristics"</a> , <a href="#">Section 1.1: "Characteristics (curves)"</a> , <a href="#">Section 2: "Package information"</a> and <a href="#">Section 3: "Ordering information"</a> .

**IMPORTANT NOTICE – PLEASE READ CAREFULLY**

STMicroelectronics NV and its subsidiaries ("ST") reserve the right to make changes, corrections, enhancements, modifications, and improvements to ST products and/or to this document at any time without notice. Purchasers should obtain the latest relevant information on ST products before placing orders. ST products are sold pursuant to ST's terms and conditions of sale in place at the time of order acknowledgement.

Purchasers are solely responsible for the choice, selection, and use of ST products and ST assumes no liability for application assistance or the design of Purchasers' products.

No license, express or implied, to any intellectual property right is granted by ST herein.

Resale of ST products with provisions different from the information set forth herein shall void any warranty granted by ST for such product.

ST and the ST logo are trademarks of ST. All other product or service names are the property of their respective owners.

Information in this document supersedes and replaces information previously supplied in any prior versions of this document.

© 2017 STMicroelectronics – All rights reserved