

SCHEMATIC

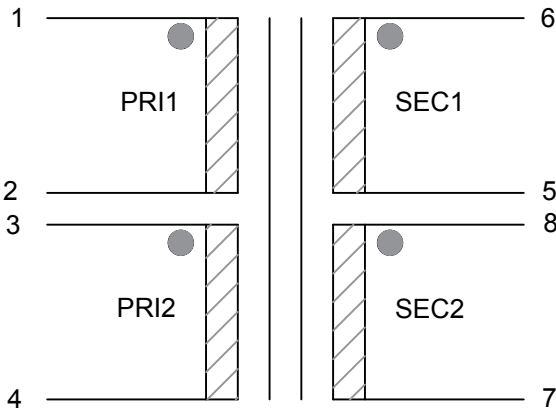

Specifications valid for all types:

Input voltage 2x115V, 50/60Hz
 HV test 0.5KVAC (prim-prim & sec-sec)
 4KVAC (prim-sec)

Ambient Temperature T 70 °F

Isolation class VDE* F 155 °C

Safety Approval VDE, UL, CE

*Refer to next page

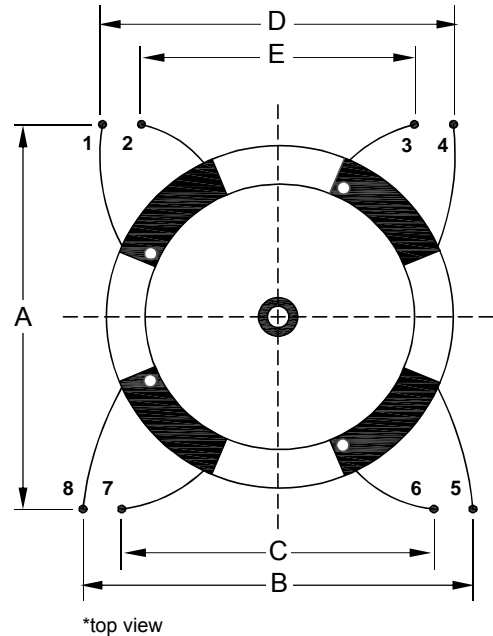
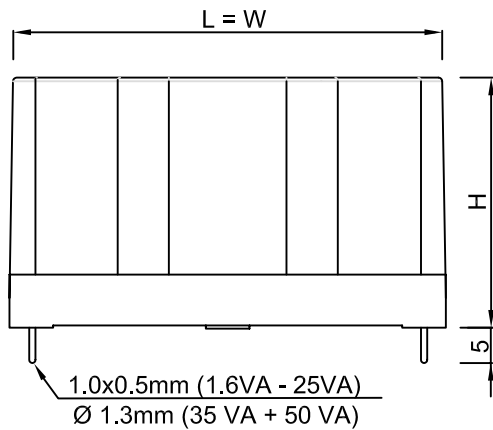

DIMENSIONS – L01 SERIES

VA RATING	L	W	H	A	B	C	D	E
1.6	39.60	39.60	18.50	35.56	35.56	25.40	30.48	20.32
3.2	44.70	44.70	19.50	40.64	40.64	30.48	35.56	25.40
5	49.70	49.70	19.50	45.72	45.72	35.56	40.64	30.48
7	49.70	49.70	23.10	45.72	45.72	35.56	40.64	30.48
10	55.00	55.00	26.00	50.80	50.80	40.64	45.72	35.56
15	60.00	60.00	26.30	55.88	55.88	45.72	50.80	40.64
25	60.00	60.00	37.50	55.88	55.88	45.72	50.80	40.64
35	72.00	72.00	37.50	66.04	66.04	55.88	60.96	50.80
50	82.40	82.40	37.50	76.20	76.20	66.04	71.12	60.96

*in mm



L01 Series 50 / 60 Hz PC Mount Toroidal Transformers

1.6 VA	Part Number	Secondary	No load voltage	Resistance 20°C	
	L01-6300	2 x 7V 114 mA	2 x 9V	2 x 8.80Ω	Weight total = 80 g Weight Cu = 20 g Efficiency = 77% External Fuse 32mA (stb) at 230V Fixing = M4 threaded screw
	L01-6301	2 x 9V 89 mA	2 x 11.6V	2 x 15.8Ω	
	L01-6302	2 x 12V 67 mA	2 x 15.4V	2 x 26.9Ω	
	L01-6303	2 x 15V 53 mA	2 x 19.3V	2 x 43.4Ω	
	L01-6304	2 x 18V 44 mA	2 x 23.4V	2 x 65.9Ω	
	* L01-6305	2 x 22V 36 mA	2 x 28.2V	2 x 88.1Ω	
3.2 VA	Part Number	Secondary	No load voltage	Resistance 20°C	
	L01-6310	2 x 7V 229 mA	2 x 10.2V	2 x 7.0Ω	Weight total = 110 g Weight Cu = 26 g Efficiency = 70% External Fuse 32mA (stb) at 230V Fixing = M4 threaded screw
	L01-6311	2 x 9V 178 mA	2 x 13.0V	2 x 11.3Ω	
	L01-6312	2 x 12V 133 mA	2 x 17.3V	2 x 20.7Ω	
	L01-6313	2 x 15V 107 mA	2 x 21.4V	2 x 28.9Ω	
	* L01-6314	2 x 18V 89 mA	2 x 25.7V	2 x 45.4Ω	
	* L01-6315	2 x 22V 73 mA	2 x 31.3V	2 x 62.2Ω	
5 VA	Part Number	Secondary	No load voltage	Resistance 20°C	
	L01-6320	2 x 7V 357 mA	2 x 9.7V	2 x 4.0Ω	Weight total = 144 g Weight Cu = 33 g Efficiency = 68% External Fuse 50mA (stb) at 230V Fixing = M4 threaded screw
	L01-6321	2 x 9V 278 mA	2 x 12.4V	2 x 6.5Ω	
	L01-6322	2 x 12V 208 mA	2 x 17.0V	2 x 12.3Ω	
	L01-6323	2 x 15V 167 mA	2 x 21.3V	2 x 19.0Ω	
	* L01-6324	2 x 18V 139 mA	2 x 25.5V	2 x 28.8Ω	
	* L01-6325	2 x 22V 114 mA	2 x 30.5V	2 x 39.1Ω	
7 VA	Part Number	Secondary	No load voltage	Resistance 20°C	
	L01-6330	2 x 7V 500 mA	2 x 9.5V	2 x 2.5Ω	Weight total = 174 g Weight Cu = 36 g Efficiency = 74% External Fuse 63mA (stb) at 230V Fixing = M4 threaded screw
	L01-6331	2 x 9V 389 mA	2 x 12.2V	2 x 4.1Ω	
	L01-6332	2 x 12V 292 mA	2 x 16.2V	2 x 7.7Ω	
	L01-6333	2 x 15V 233 mA	2 x 20.3V	2 x 12.0Ω	
	L01-6334	2 x 18V 194 mA	2 x 24.3V	2 x 17.9Ω	
	* L01-6335	2 x 22V 159 mA	2 x 29.7V	2 x 24.4Ω	
10 VA	Part Number	Secondary	No load voltage	Resistance 20°C	
	L01-6340	2 x 7V 714 mA	2 x 8.3V	2 x 1.0Ω	Weight total = 252 g Weight Cu = 45 g Efficiency = 82% External Fuse 80mA (stb) at 230V Fixing = M4 threaded screw
	L01-6341	2 x 9V 556 mA	2 x 10.8V	2 x 1.7Ω	
	L01-6342	2 x 12V 417 mA	2 x 14.4V	2 x 3.2Ω	
	L01-6343	2 x 15V 333 mA	2 x 18.0V	2 x 5.0Ω	
	L01-6344	2 x 18V 278 mA	2 x 21.7V	2 x 7.5Ω	
	* L01-6345	2 x 22V 227 mA	2 x 26.3V	2 x 10.3Ω	
15 VA	Part Number	Secondary	No load voltage	Resistance 20°C	
	L01-6350	2 x 7V 1071 mA	2 x 8.9V	2 x 0.85Ω	Weight total = 304 g Weight Cu = 57 g Efficiency = 80% External Fuse 100mA (stb) at 230V Fixing = M4 threaded screw
	L01-6351	2 x 9V 833 mA	2 x 11.1V	2 x 1.3Ω	
	L01-6352	2 x 12V 625 mA	2 x 14.8V	2 x 2.3Ω	
	L01-6353	2 x 15V 500 mA	2 x 18.5V	2 x 3.1Ω	
	L01-6354	2 x 18V 417 mA	2 x 22.2V	2 x 5.3Ω	
	* L01-6355	2 x 22V 341 mA	2 x 27.2V	2 x 7.4Ω	
25 VA	Part Number	Secondary	No load voltage	Resistance 20°C	
	L01-6360	2 x 7V 1785 mA	2 x 8.3V	2 x 0.4Ω	Weight total = 435 g Weight Cu = 85 g Efficiency = 83% External Fuse 160mA (stb) at 230V Fixing = M4 threaded screw
	L01-6361	2 x 9V 1377 mA	2 x 10.7V	2 x 0.7Ω	
	L01-6362	2 x 12V 1041 mA	2 x 14.3V	2 x 1.3Ω	
	L01-6363	2 x 15V 832 mA	2 x 17.8V	2 x 2.0Ω	
	L01-6364	2 x 18V 694 mA	2 x 21.4V	2 x 2.7Ω	
	* L01-6365	2 x 22V 568 mA	2 x 26.2V	2 x 4.1Ω	
35 VA	Part Number	Secondary	No load voltage	Resistance 20°C	
	L01-6370	2 x 7V 2500 mA	2 x 8.2V	2 x 0.19Ω	Weight total = 590 g Weight Cu = 187 g Efficiency = 82% External Fuse 200mA (stb) at 230V Fixing = M5 threaded screw
	L01-6371	2 x 9V 1944 mA	2 x 10.6V	2 x 0.32Ω	
	L01-6372	2 x 12V 1458 mA	2 x 14.0V	2 x 0.53Ω	
	L01-6373	2 x 15V 1167 mA	2 x 17.6V	2 x 0.84Ω	
	L01-6374	2 x 18V 972 mA	2 x 20.9V	2 x 1.10Ω	
	* L01-6375	2 x 22V 795 mA	2 x 25.7V	2 x 1.34Ω	
50 VA	Part Number	Secondary	No load voltage	Resistance 20°C	
	L01-6380	2 x 7V 3571 mA	2 x 8.1V	2 x 0.13Ω	Weight total = 800 g Weight Cu = 209 g Efficiency = 85% External Fuse 315mA (stb) at 230V Fixing = M5 threaded screw
	L01-6381	2 x 9V 2777 mA	2 x 10.4V	2 x 0.20Ω	
	L01-6382	2 x 12V 2083 mA	2 x 13.9V	2 x 0.34Ω	
	L01-6383	2 x 15V 1666 mA	2 x 17.3V	2 x 0.54Ω	
	L01-6384	2 x 18V 1389 mA	2 x 20.8V	2 x 0.82Ω	
	* L01-6385	2 x 22V 1136 mA	2 x 25.4V	2 x 1.25Ω	

* Not Applicable for VDE