

NTR Series

Thin Film Chip Resistors

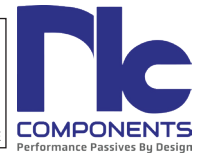

FEATURES

- PRECISE TOLERANCE AND TEMPERATURE COEFFICIENT
- EIA STANDARD CASE SIZES (0201 ~ 2512)
- LOW NOISE, THIN FILM (NiCr) CONSTRUCTION
- REFLOW SOLDERABLE (Pb FREE TERMINATION FINISH)

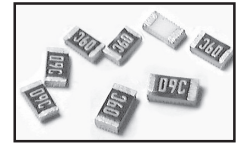

Type	EIA Size	Power Rating at 70°C	Max.*1 Working Voltage	Max.*2 Overload Voltage	Resistance Tolerance (Code)	Temperature Coefficient (ppm/°C)	Resistance Range (Ω)	Resistance Values
NTR02	0201	1/32 (0.032)W	15V	30V	±0.1% (B), ±0.25 (C), ±0.5% (D), ±1% (F)	±25 (C), ±50 (D)	22 ~ 75KΩ	E-24, E-96 & E-192
NTR04	0402	1/16 (0.063)W	50V	100V	±0.01% (T), ±0.05% (A), ±0.1% (B)	±1 (Z) ±2 (X), ±3 (O)	49.9 ~ 4.99KΩ	
					±0.01% (T), ±0.05% (A), ±0.1% (B), ±0.25 (C), ±0.5% (D), ±1% (F)	±5 (S)	49.9 ~ 20KΩ	
					±0.01% (T), ±0.05% (A)	±10 (B), ±15 (N)	49.9 ~ 20KΩ	
					±0.1% (B), ±0.25 (C), ±0.5% (D), ±1% (F)		49.9 ~ 100KΩ	
					±0.05% (A)	49.9 ~ 12KΩ		
±0.1% (B), ±0.25% (C), ±0.5% (D), ±1% (F)	±25(C), ±50(D)	4.3 ~ 511KΩ						
NTR06	0603	1/16 (0.063)W	50V	100V	±0.01% (T), ±0.05% (A), ±0.1% (B), ±0.25 (C), ±0.5% (D), ±1% (F)	±1 (Z) ±2 (X), ±3 (O)	24.9 ~ 15KΩ	
					±0.01% (T)	±10(B), ±15(N)	24.9 ~ 59KΩ	
					±0.05% (A)		24.9 ~ 100KΩ	
					±0.1% (B), ±0.25 (C), ±0.5% (D), ±1% (F)	4.7 ~ 332KΩ		
					±0.05% (A)	4.7 ~ 511KΩ		
					±0.1% (B), ±0.25 (C), ±0.5 (D), ±1% (F)	±25(C), ±50(D)	4.7 ~ 332KΩ 1.0 ~ 1MΩ	
NTR10	0805	1/10 (0.10) W	100V	200V	±0.01% (T), ±0.05% (A), ±0.1% (B), ±0.25 (C), ±0.5% (D), ±1% (F)	±1 (Z) ±2 (X), ±3 (O)	24.9 ~ 30KΩ	
					±0.01% (T), ±0.05% (A), ±0.1% (B), ±0.25 (C), ±0.5% (D), ±1% (F)	±5 (S)	24.9 ~ 150KΩ	
					±0.01% (T)	±10(B), ±15(N)	24.9 ~ 200KΩ	
					±0.05% (A), ±0.1% (B), ±0.25 (C), ±0.5% (D), ±1% (F)		4.7 ~ 1MΩ	
					±0.05 (A)	4.7 ~ 1MΩ		
±0.1% (B), ±0.25 (C), ±0.5 (D), ±1% (F)	±25(C), ±50(D)	1.0 ~ 2MΩ						
NTR12	1206	1/8 (0.125) W	150V	300V	±0.01% (T), ±0.05% (A), ±0.1% (B), ±0.25 (C), ±0.5% (D), ±1% (F)	±1 (Z) ±2 (X), ±3 (O)	24.9 ~ 49.9KΩ	
					±0.01% (T), ±0.05% (A), ±0.1% (B), ±0.25 (C), ±0.5% (D), ±1% (F)	±5 (S)	24.9 ~ 300KΩ	
					±0.01% (T)	±10(B), ±15(N)	24.9 ~ 499KΩ	
					±0.05% (A), ±0.1% (B), ±0.25 (C), ±0.5% (D), ±1% (F)		4.7 ~ 1.5MΩ	
					±0.05% (A)	1.0 ~ 1MΩ		
±0.1% (B), ±0.25 (C), ±0.5 (D), ±1% (F)	±25(C), ±50(D)	1.0 ~ 3MΩ						
NTR20	1210	1/4 (0.25) W	150V	300V	±0.01% (T), ±0.05% (A), ±0.1% (B), ±0.25 (C), ±0.5% (D), ±1% (F)	±1 (Z) ±2 (X), ±3 (O)	24.9 ~ 49.9KΩ	
					±0.01% (T), ±0.05% (A), ±0.1% (B), ±0.25 (C), ±0.5% (D), ±1% (F)	±5 (S)	24.9 ~ 300KΩ	
					±0.01% (T)	±10(B), ±15(N)	24.9 ~ 499KΩ	
					±0.05% (A), ±0.1% (B), ±0.25 (C), ±0.5% (D), ±1% (F)		4.7 ~ 1MΩ	
					±0.05% (A)	1.0 ~ 1MΩ		
±0.1% (B), ±0.25 (C), ±0.5 (D), ±1% (F)	±25(C), ±50(D)	1.0 ~ 3MΩ						

For 2010 and 2512 case sizes see page 2

NTR Series

Thin Film Chip Resistors



Type	EIA Size	Power Rating at 70°C	Max.*1 Working Voltage	Max.*2 Overload Voltage	Resistance Tolerance (Code)	Temperature Coefficient (ppm/°C)	Resistance Range (Ω)	Resistance Values
NTR25	2010	1/4 (0.25) W	150V	300V	±0.01% (T), ±0.05% (A), ±0.1% (B),	±1 (Z) ±2 (X), ±3 (O)	24.9 ~ 100KΩ	E-24, E-96 & E-192
					±0.01% (T), ±0.05% (A), ±0.1% (B), ±0.25 (C), ±0.5% (D), ±1% (F)	±5 (S)	24.9 ~ 300KΩ	
					±0.01% (T)	±10(B), ±15(N)	24.9 ~ 499KΩ	
					±0.05% (A), ±0.1% (B), ±0.25 (C), ±0.5% (D), ±1% (F)		4.7 ~ 1MΩ	
					±0.05% (A)	±25(C), ±50(D)	1.0 ~ 1MΩ	
					±0.1% (B), ±0.25 (C), ±0.5 (D), ±1% (F)		1.0 ~ 3MΩ	
NTR50	2512	1/2 (0.50) W	150V	300V	±0.01% (T), ±0.05% (A), ±0.1% (B),	±1 (Z) ±2 (X), ±3 (O)	24.9 ~ 100KΩ	E-24, E-96 & E-192
					±0.01% (T), ±0.05% (A), ±0.1% (B), ±0.25 (C), ±0.5% (D), ±1% (F)	±5 (S)	24.9 ~ 300KΩ	
					±0.01% (T)	±10(B), ±15(N)	24.9 ~ 499KΩ	
					±0.05% (A), ±0.1% (B), ±0.25 (C), ±0.5% (D), ±1% (F)		4.7 ~ 1MΩ	
					±0.05% (A)	±25(C), ±50(D)	4.7 ~ 1MΩ	
					±0.1% (B), ±0.25 (C), ±0.5 (D), ±1% (F)		1.0 ~ 3MΩ	

Note *1 - Maximum allowable continuous Working Voltage for all resistors is the lower of the two values:
 "Maximum Working Voltage" as specified above
 or

$$\sqrt{\text{Power rating (Watts)} \times \text{Resistance (Ohms)}}$$

Note *2 - Maximum Overload Voltage for all resistors is the lower of the two values:
 "Maximum Overload Voltage" as specified above
 or

$$2 \times \sqrt{\text{Power rating (Watts)} \times \text{Resistance (Ohms)}}$$

Power Derating Curve: For operation above 70°C, power rating must be derated according to the following chart:

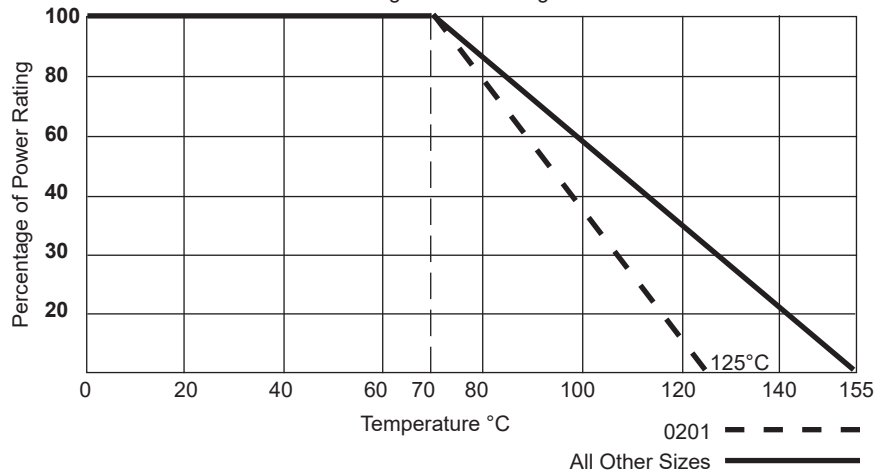

NTR Series

Thin Film Chip Resistors



ENVIRONMENTAL CHARACTERISTICS

Item	Specification		Test Method*
	Tol. ≤ 0.05%	Tol. > 0.05%	
Standard Temperature Range: -55°C ~ +155°C (power derating above +70°C)			
Temperature Coefficient of Resistance	As specified		MIL-STD-202 Method 304 +25/-55/+25/+125/+25
Short Time Overload	ΔR ±0.05%	ΔR ±0.1% ΔR ±0.2% for 0201	JIS-C-5201-1 4:13 RCWV x 2.5 or Max Overloading Voltage for 5 Seconds
	ΔR ±0.2% for Ultra High Power		
Dielectric Withstanding Voltage	As specified		MIL-STD-202F Method 301 Apply Max. Overload Voltage for 1 minute
Insulation Resistance	>9999MΩ		MIL-STD-202 Method 302 Apply 100Vdc for 1 minute
Load Life (Endurance)	ΔR ±0.05%	ΔR ±0.1%	MIL-STD-202 Method 108A RCWV +70°C±2°C, 1.5 hours ON, 0.5 hours OFF Total time 1,000
	For 0201: >7KΩ ΔR ±0.5% ≤7KΩ ΔR ±0.2%		
	ΔR ±0.5% for Ultra High Power		
Bias Humidity	ΔR ±0.1% (0201 is excluded)		MIL-STD-202 Method 103 1,000 hours at +85°C/85% RH 10% power
Damp Heat with Load (0201)	ΔR ±0.3%		MIL-STD-202 Method 103B +40°C ±2°C, 90~95% R.H. RCWV for 1000 hrs with 1.5 hrs "ON" and 0.5 hrs "OFF"
Low Temperature Operation	ΔR ±0.05%	ΔR ±0.2%	JIS-C-5201-1 4.36 1 hour @ -65°C followed by 45 minutes of RCWV
	ΔR ±0.5% for Ultra High Power		
Bending Strength	ΔR ±0.05%	ΔR ±0.1%	JIS-C-5201-1 4.33 Bending Amplitude: 2010 & 2512 2mm for 60 seconds All others 3mm for 60 seconds
Solderability	95% Minimum Coverage		MIL-STD-202 Method 208H 245°C ±5°C, 3 seconds
Resistance to Soldering Heat	ΔR ±0.05%	ΔR ±0.1%	MIL-STD-202 Method 210E 260°C ±5°C for 10 ±1 seconds
High Temperature Exposure	ΔR±0.5 for the following values 0402 ≥255.01K 0603 ≥402.01K 0805 ≥1.01M 1206 ≥1.01M 1210 ≥1.01M 2010 ≥1.01M 2512 ≥1.01M ΔR±0.2 for all others		MIL-STD-202 Method 108 at 155°C for 1,000 hours
Temperature Cycling	ΔR±0.2 excluding the 0201 case size		JESD22 Method JA-104 -55°C to +125°C, 1000 cycles
ESD	ΔR±0.5 excluding the 0201 case size		AEC-Q200-002 (Human Body Model) Size 0402 & 0603: 200V Size 0805 & 1206: 1000V Size 1210, 2010 & 2512: 2000V
Sulfur Test	ΔR±0.2 excluding the 0201 case size		ASTM-B-809-95 Modified 105°C±2°C no power rating for 1000 hrs.

Storage Conditions: +15°C ~ +28°C; Humidity < 80% RH
Shelf Life: 2 years from production date

Performance Passives By Design

NTR Series

Thin Film Chip Resistors



STANDARD E-24, E-96 AND E-192 VALUES AND 0603 RESISTANCE CODES

E-24 Value	E-96								E-192*					
	Value	Code	Value	Code	Value	Code	Value	Code	Value	Value	Value	Value	Value	Value
100	100	01	102	02	105	03	107	04	100	147	215	316	464	681
110	110	05	113	06	115	07	118	08	101	149	218	320	470	690
120	121	09	124	10	127	11	130	12	102	150	221	324	475	698
130	133	13	137	14	140	15	143	16	104	152	223	328	481	706
150	147	17	150	18	154	19	158	20	105	154	226	332	487	715
160	162	21	165	22	169	23	174	24	106	156	229	336	493	723
180	178	25	182	26	187	27	191	28	107	158	232	340	499	732
200	196	29	200	30	205	31	210	32	109	160	234	344	505	741
220	215	33	221	34	226	35	232	36	110	162	237	348	511	750
240	237	37	243	38	249	39	255	40	111	164	240	352	517	759
270	261	41	267	42	274	43	280	44	113	165	243	357	523	768
300	287	45	294	46	301	47	309	48	114	167	246	361	530	777
330	316	49	324	50	332	51	340	52	115	169	249	365	536	787
360	348	53	357	54	365	55	374	56	117	172	252	370	542	796
390	383	57	392	58	402	59	412	60	118	174	255	374	549	806
430	422	61	432	62	442	63	453	64	120	176	258	379	556	816
470	464	65	475	66	487	67	499	68	121	178	261	383	562	825
510	511	69	523	70	536	71	549	72	123	180	264	388	569	835
560	562	73	576	74	590	75	604	76	124	182	267	392	576	845
620	619	77	634	78	649	79	665	80	126	184	271	397	583	856
680	681	81	698	82	715	83	732	84	127	187	274	402	590	866
750	750	85	768	86	787	87	806	88	129	189	270	407	597	876
820	825	89	845	90	866	91	887	92	130	191	280	412	604	887
910	909	93	931	94	953	95	976	96	132	193	284	417	612	898
									133	196	287	422	619	909
									135	198	291	427	626	920
									137	200	294	432	634	931
									138	203	298	437	642	942
									140	205	301	442	649	953
									142	208	305	448	657	965
									143	210	309	453	665	976
									145	213	312	459	673	988

* Special E192 resistance values are supported on all case sizes of NTR series. Please review your E192 value requirements with NIC, as special terms apply, and E192 values are supplied without component resistance value marking.

MULTIPLIER CODE

Code	A	B, b	C	D, d	E	F	G	H	X	Y	Z
Multiplier	10 ⁰	10 ¹	10 ²	10 ³	10 ⁴	10 ⁵	10 ⁶	10 ⁷	10 ⁻¹	10 ⁻²	10 ⁻³

NTR Series

Thin Film Chip Resistors



PART MARKING

- No marking on 0402 case size.
- Marking for 0603 case size:
E-24 values and E-96 values: $\pm 1\%$ (F), $\pm 0.5\%$ (D), $\pm 0.25\%$ (C), $\pm 0.1\%$ (B) tolerances
E-192 values: $\pm 0.1\%$ (B) tolerance (No Marking)

CODING FORMULA

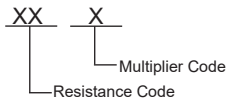

Example: $10.2k\Omega = \frac{102}{02} \times \frac{10^2}{C} \Omega = 02C$
 $33.2 \Omega = \frac{332}{51} \times \frac{10^{-1}}{X} = 51X$

MARKING EXAMPLES

$10\Omega = 01X$
 $7.5k \Omega = 85B$
 $150k \Omega = 18D$
 $1 \text{ Meg}\Omega = 01E$

- Marking for 0805, 1206, 2010 and 2512 case sizes:
E-24 and E-96 values - $\pm 1\%$ (F), $\pm 0.5\%$ (D), $\pm 0.25\%$ (C), $\pm 0.1\%$ (B) tolerances
E-192 values: $\pm 0.1\%$ (B) tolerance (No Marking)

4 DIGIT MARKING SYSTEM - First 3 digits are the significant figures, the 4th digit is the multiplier. "R" = decimal point.

Examples: 0R10 = 0.10 ohms, 1R00 = 1.0 ohms, 22R1=22.1 ohms, 3320= 332 ohms, 4751=4.75K ohms, 1132=11.3K ohms, 6493=649K ohms

PART NUMBER SYSTEM

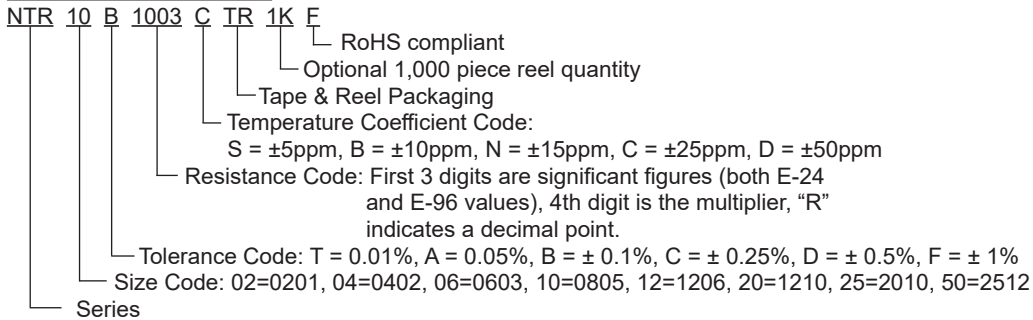

DIMENSIONS (mm)

Type	Power Rating	EIA Size	L	W	H	T	t
NTR02	1/32W	0201	0.58 ± 0.05	0.29 ± 0.05	0.23 ± 0.05	0.12 ± 0.05	0.15 ± 0.05
NTR04	1/16W	0402	1.00 ± 0.05	0.50 ± 0.05	0.30 ± 0.05	0.20 ± 0.15	0.20 ± 0.10
NTR06	1/16W	0603	1.55 ± 0.10	0.80 ± 0.10	0.45 ± 0.10	0.30 ± 0.25	0.30 ± 0.20
NTR10	1/10W	0805	2.00 ± 0.15	1.25 ± 0.15	0.55 ± 0.10	0.30 ± 0.25	0.40 ± 0.20
NTR12	1/8W	1206	3.05 ± 0.15	1.55 ± 0.15	0.55 ± 0.10	0.42 ± 0.30	0.35 ± 0.25
NTR20	1/4W	1210	3.10 ± 0.15	2.40 ± 0.15	0.55 ± 0.10	0.40 ± 0.30	0.55 ± 0.25
NTR25	1/4W	2010	4.90 ± 0.15	2.40 ± 0.15	0.55 ± 0.10	0.60 ± 0.40	0.50 ± 0.25
NTR50	1/2W	2512	6.30 ± 0.15	3.10 ± 0.15	0.55 ± 0.10	0.60 ± 0.40	0.50 ± 0.25

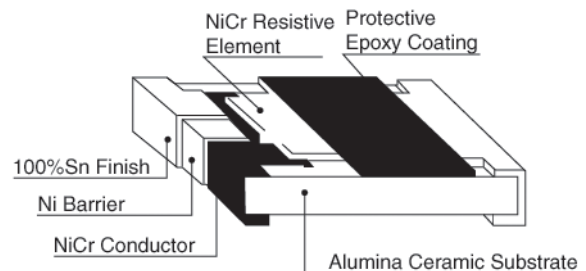
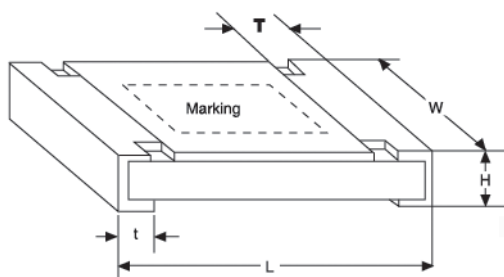

NTR Series

Thin Film Chip Resistors



TAPING SPECIFICATIONS

(1) Availability

Type	Power Rating	EIA Size	Carrier Tape			Qty per Reel (pcs)	
			Fig.	Material	Width (mm)	Standard	Optional
NTR02	1/32W	0201	A	Paper	8	10,000	1,000
NTR04	1/16W	0402	A			10,000	1,000
NTR06	1/16W	0603	A			5,000	1,000
NTR10	1/10W	0805	A				
NTR12	1/8W	1206	A				
NTR20	1/4W	1210	B			Plastic	12
NTR50	1/2W	2512	B				

(2) PAPER TAPE DIMENSIONS (mm)

FIG. A

Type	EIA Size	A	B	D	E	F	P ₀	P ₁	P ₂	W	T
NTR02	0201	0.40 ± 0.05	0.70 ± 0.05	1.55 ± 0.05	1.75 ± 0.05	3.50 ± 0.05	4.0 ± 0.10	2.0 ± 0.05	2.0 ± 0.05	8.0 ± 0.1	0.42 ± 0.02
NTR04	0402	0.70 ± 0.05	1.16 ± 0.05								0.40 ± 0.03
NTR06	0603	1.10 ± 0.05	1.90 ± 0.05					4.0 ± 0.10			0.60 ± 0.03
NTR10	0805	1.60 ± 0.05	2.37 ± 0.05								
NTR12	1206	2.00 ± 0.05	3.55 ± 0.05					0.75 ± 0.05			
NTR20	1210	2.75 ± 0.05	3.40 ± 0.05								1.60 ± 0.10

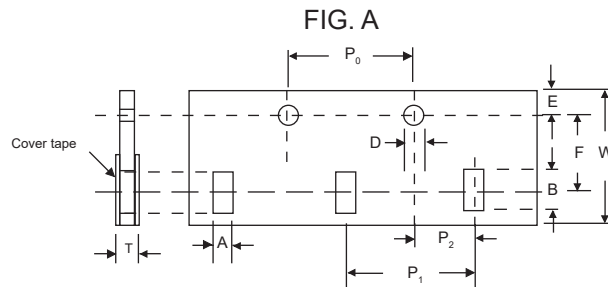

(3) PLASTIC EMBOSSED TAPE DIMENSIONS (mm)

FIG. B

Type	EIA Size	A	B	D	E	F	P ₀	P ₁	P ₂	W	T
NTR25	2010	2.85 ± 0.10	5.45 ± 0.10	1.50 ± 0.10	1.75 ± 0.10	5.50 ± 0.05	4.0 ± 0.05	4.0 ± 0.10	2.0 ± 0.05	12.0 ± 0.1	1.0 ± 0.20
NTR50	2512	3.40 ± 0.10	6.65 ± 0.10								

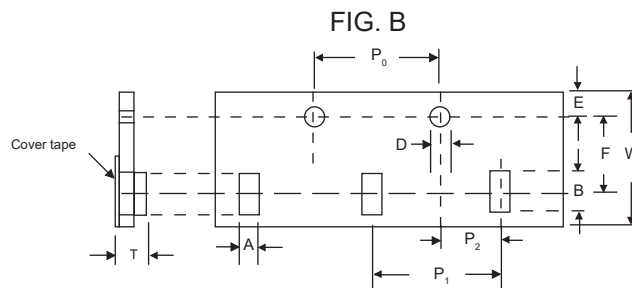

NTR Series

Thin Film Chip Resistors



REEL DIMENSIONS (mm)

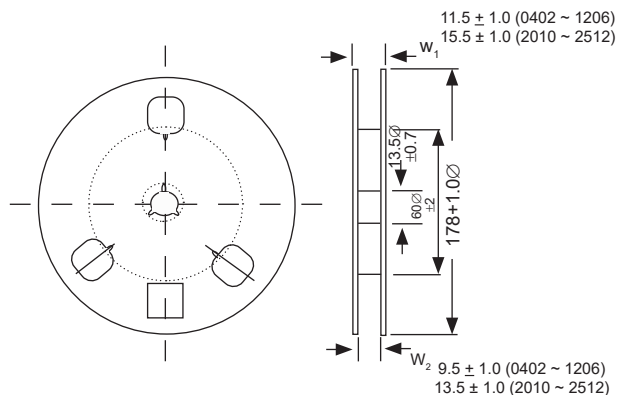

LAND PATTERN DIMENSIONS (mm)

Type	EIA Size	A	B	C
NTR02	0201	0.25	0.30	0.40 ± 0.2
NTR04	0402	0.50	0.50	0.60 ± 0.2
NTR06	0603	0.80	1.00	0.90 ± 0.2
NTR10	0805	1.00	1.00	1.35 ± 0.2
NTR12	1206	2.00	1.15	1.70 ± 0.2
NTR20	1210	2.00	1.15	2.50 ± 0.2
NTR25	2010	3.60	1.40	2.50 ± 0.2
NTR50	2512	4.90	1.60	3.10 ± 0.2



Reflow Soldering Heat Profile and Limits

→ [ReflowSolderingHeat-Profile-IPCJEDEC-ReflowSolderingHeat-Profile-IPCJEDEC-NIC-ChipR-Reflow-May2022-Rev3](#)

Wave soldering? – Please review your wave soldering process profile with NIC: tpmg@niccomp.com

