

**C106 Series**



**Description**

Glassivated PNP devices designed for high volume consumer applications such as temperature, light, and speed control; process and remote control, and warning systems where reliability of operation is important.

**Features**

- Glassivated Surface for Reliability and Uniformity
- Power Rated at Economical Prices
- Practical Level Triggering and Holding Characteristics
- Flat, Rugged, Thermopad Construction for Low Thermal Resistance, High Heat Dissipation and Durability
- Sensitive Gate Triggering
- These are Pb-Free Devices

**Pin Out**

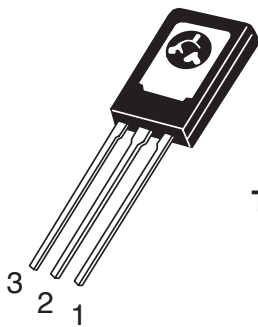

**TO-225AA  
CASE 77  
STYLE 2**

**Functional Diagram**

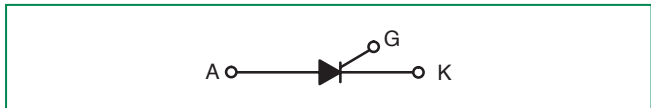

**Additional Information**



**Datasheet**



**Resources**



**Samples**

### Maximum Ratings ( $T_J = 25^\circ\text{C}$ unless otherwise noted)

| Rating  |                | Symbol                               | Value       | Unit             |
|---|----------------|--------------------------------------|-------------|------------------|
| Peak Repetitive Off-State Voltage (Note 1)<br>( $T_J = 25$ to $110^\circ\text{C}$ , Gate Open)  | C106B          | $V_{\text{DRM}}$<br>$V_{\text{RRM}}$ | 200         | V                |
|   | C106D, C106D1* |                                      | 400         |                  |
|   | C106M,         |                                      | 600         |                  |
| On-State RMS Current ( $T_C = 70^\circ\text{C}$ )(Full Cycle Sine Wave 50 to 60 Hz)             |                | $I_{\text{T (RMS)}}$                 | 4.0         | A                |
| Average On-State Current ( $180^\circ$ Conduction Angles, $T_C = 80^\circ\text{C}$ )            |                | $I_{\text{T(AV)}}$                   | 2.55        | A                |
| Peak Non-Repetitive Surge Current<br>(1/2 Cycle, Sine Wave, 60 Hz, $T_J = +25^\circ\text{C}$ )  |                | $I_{\text{TSM}}$                     | 20          | A                |
| Circuit Fusing Considerations ( $t = 8.3$ ms)   |                | $I^2t$                               | 1.65        | A2s              |
| Forward Peak Gate Power (Pulse Width $\leq 1.0$ $\mu\text{sec}$ , $T_C = 80^\circ\text{C}$ )    |                | $P_{\text{GM}}$                      | 0.5         | W                |
| Forward Average Gate Power (Pulse Width $\leq 1.0$ $\mu\text{sec}$ , $T_C = 80^\circ\text{C}$ ) |                | $P_{\text{G(AV)}}$                   | 0.1         | W                |
| Operating Junction Temperature Range  |                | $T_J$                                | -40 to +110 | $^\circ\text{C}$ |
| Storage Temperature Range   |                | $T_{\text{stg}}$                     | -40 to +150 | $^\circ\text{C}$ |
| Mounting Torque (Note 2)  |                | -                                    | 6.0         | in. lb.          |

Stresses exceeding Maximum Ratings may damage the device. Maximum Ratings are stress ratings only. Functional operation above the Recommended Operating Conditions is not implied. Extended exposure to stresses above the Recommended Operating Conditions may affect device reliability.

- $V_{\text{DRM}}$  and  $V_{\text{RRM}}$  for all types can be applied on a continuous basis. Ratings apply for zero or negative gate voltage; however, positive gate voltage shall not be applied concurrent with negative potential on the anode. Blocking voltages shall not be tested with a constant current source such that the voltage ratings of the devices are exceeded.
- Torque rating applies with use of torque washer (Shakeproof WD19523 or equivalent). Mounting Torque in excess of 6 in. lb. does not appreciably lower case-to-sink thermal resistance. Main terminal 2 and heat-sink contact pad are common.

### Thermal Characteristics

| Rating  | Symbol                | Value | Unit               |
|---|-----------------------|-------|--------------------|
| Thermal Resistance, Junction-to-Case  | $R_{\theta\text{JC}}$ | 3.0   | $^\circ\text{C/W}$ |
| Thermal Resistance, Junction-to-Ambient   | $R_{\theta\text{JA}}$ | 75    | $^\circ\text{C/W}$ |
| Maximum Device Temperature for Soldering Purposes 1/8 in. from case for 10 Secs Maximum | $T_L$                 | 260   | $^\circ\text{C}$   |

### Electrical Characteristics - OFF ( $T_J = 25^\circ\text{C}$ unless otherwise noted)

| Characteristic  |                           | Symbol    | Min | Typ | Max | Unit          |
|---|---------------------------|-----------|-----|-----|-----|---------------|
| Peak Repetitive Forward or Reverse Blocking Current<br>( $V_{AK} = \text{Rated } V_{DRM}$ or $V_{RRM}$ , $R_{GK} = 1 \text{ k}\Omega$ ) | $T_J = 25^\circ\text{C}$  | $I_{DRM}$ | –   | –   | 10  | $\mu\text{A}$ |
|   | $T_J = 110^\circ\text{C}$ | $I_{RRM}$ | –   | –   | 100 | $\mu\text{A}$ |

### Electrical Characteristics - ON ( $T_J = 25^\circ\text{C}$ unless otherwise noted; Electricals apply in both directions)

| Characteristic   |                            | Symbol    | Min | Typ  | Max | Unit          |
|--|----------------------------|-----------|-----|------|-----|---------------|
| Peak Forward On-State Voltage (Note 3) ( $I_{TM} = 4 \text{ A}$ )  |                            | $V_{TM}$  | –   | –    | 2.2 | V             |
| Gate Trigger Current (Continuous dc)<br>( $V_D = 12 \text{ V}$ , $R_L = 100 \Omega$ , All Quadrants)               | $T_J = 25^\circ\text{C}$   | $I_{GT}$  | –   | 15   | 200 | $\mu\text{A}$ |
|  | $T_J = -40^\circ\text{C}$  |           | –   | 35   | 500 |               |
| Peak Reverse Gate Voltage ( $I_{GR} = 10 \mu\text{A}$ )  |                            | $V_{GRM}$ | –   | –    | 6.0 | V             |
| Gate Trigger Voltage (Continuous dc)<br>( $V_D = 12 \text{ Vdc}$ , $R_L = 100 \Omega$ , $T_C = 25^\circ\text{C}$ ) | $T_J = 25^\circ\text{C}$   | $V_{GT}$  | 0.4 | 0.60 | 0.8 | V             |
|  | $T_J = -40^\circ\text{C}$  |           | 0.5 | 0.75 | 1.0 |               |
| Gate Non-Trigger Voltage (Continuous dc) (Note 4)  |                            | $V_{GD}$  | 0.2 | –    | –   | V             |
| Latching Current<br>( $V_{AK} = 12 \text{ V}$ , $I_G = 20 \text{ mA}$ , $R_{GK} = 1 \text{ k}\Omega$ )             | $T_J = 25^\circ\text{C}$   | $I_L$     | –   | 0.20 | 5.0 | mA            |
|  | $T_J = -40^\circ\text{C}$  |           | –   | 0.35 | 7.0 |               |
| Holding Current<br>( $V_D = 12 \text{ Vdc}$ )<br>(Initiating Current = 20 mA, $R_{GK} = 1 \text{ k}\Omega$ )       | $T_J = 25^\circ\text{C}$   | $I_H$     | –   | 0.19 | 5.0 | mA            |
|  | $T_J = -40^\circ\text{C}$  |           | –   | 0.33 | 7.0 |               |
|  | $T_J = +110^\circ\text{C}$ |           | –   | 0.07 | 2.0 |               |

### Dynamic Characteristics

| Characteristic  | Symbol | Min | Typ | Max | Unit             |
|---|--------|-----|-----|-----|------------------|
| Critical Rate-of-Rise of Off State Voltage<br>( $V_{AK} = \text{Rated } V_{DRM}$ , Exponential Waveform, $R_{GK} = 1 \text{ k}\Omega$ , $T_J = 110^\circ\text{C}$ ) | dv/dt  | –   | 8.0 | –   | V/ $\mu\text{s}$ |

3. Pulse Test: Pulse Width  $\leq 2.0 \text{ ms}$ , Duty Cycle  $\leq 2\%$ .

4.  $R_{GK}$  is not included in measurement.

### Voltage Current Characteristic of SCR

| Symbol    | Parameter                                 |
|-----------|---|
| $V_{DRM}$ | Peak Repetitive Forward Off State Voltage |
| $I_{DRM}$ | Peak Forward Blocking Current             |
| $V_{RRM}$ | Peak Repetitive Reverse Off State Voltage |
| $I_{RRM}$ | Peak Reverse Blocking Current             |
| $V_{TM}$  | Maximum On State Voltage                  |
| $I_H$     | Holding Current                           |

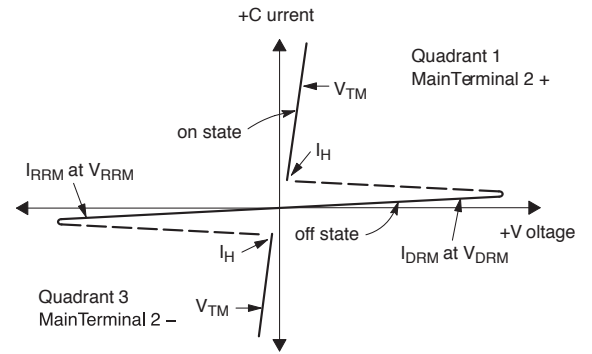

**Figure 1. Average Current Derating**

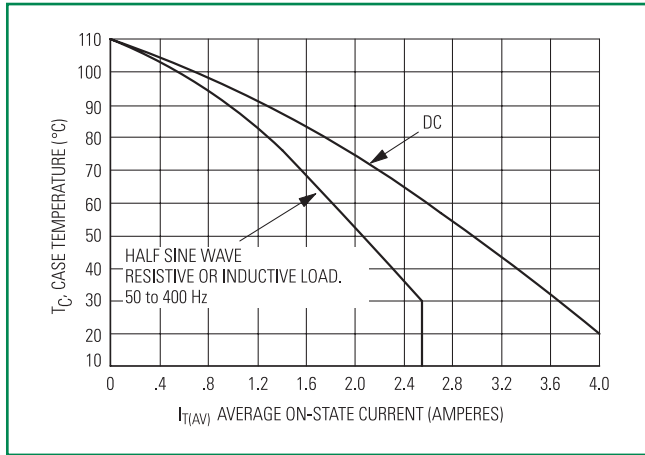

**Figure 2. Maximum On-State Power Dissipation**

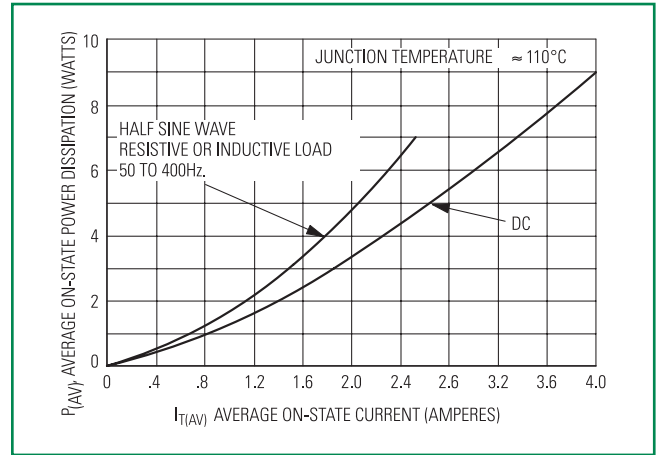

**Figure 3. Typical Gate Trigger Current vs. Junction Temp**

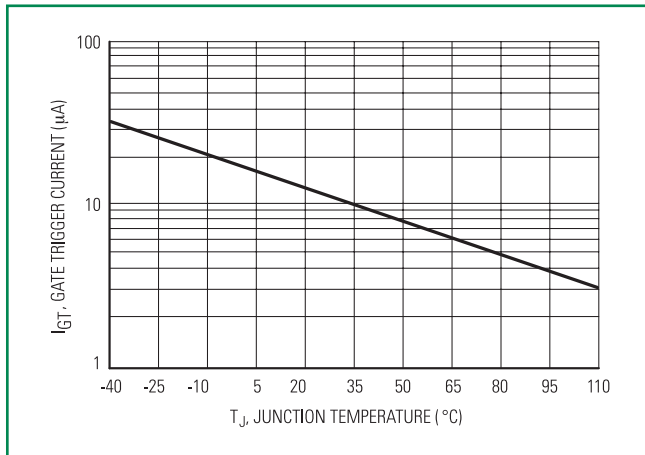

**Figure 4. Typical Holding Current vs. Junction Temp**

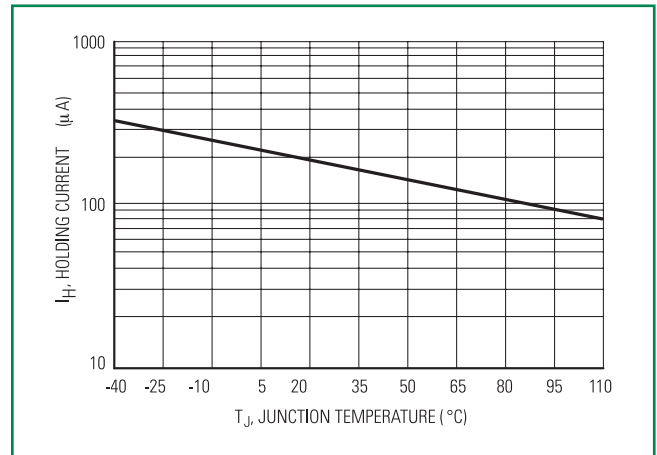

**Figure 5. Typical Gate Trigger Voltage vs. Junction Temp**

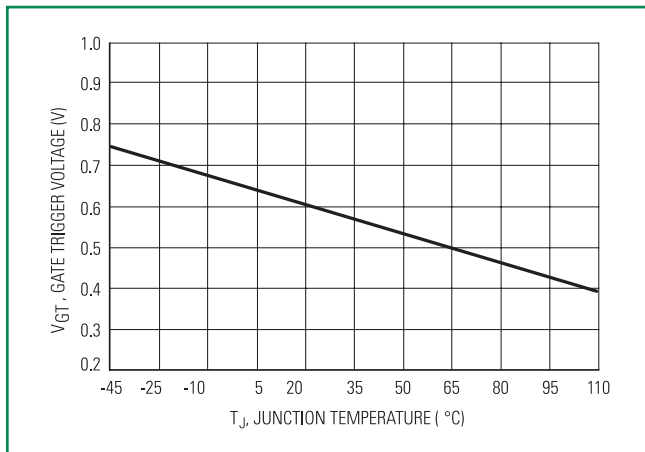

**Figure 5. Typical Latching Current vs. Junction Temp**

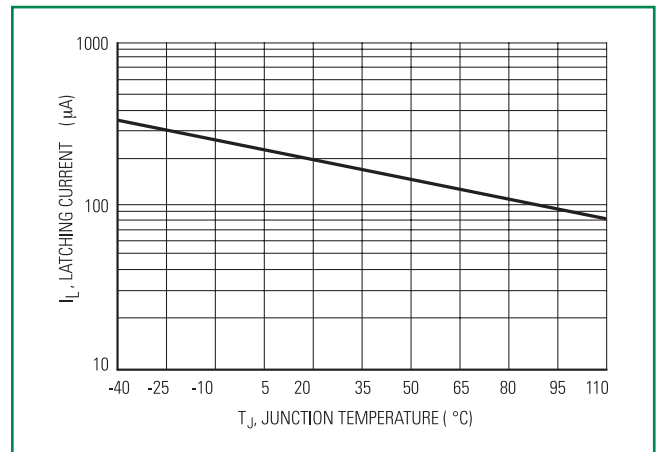

### Dimensions

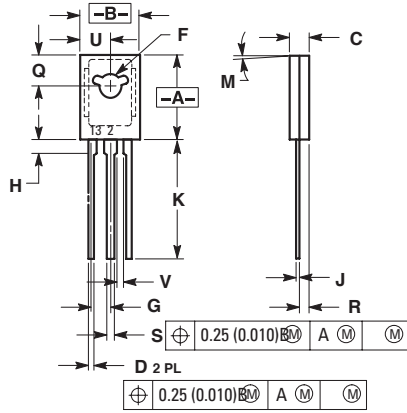

| Dim | Inches    |       | Millimeters |       |
|-----|-----------|-------|-------------|-------|
|     | Min       | Max   | Min         | Max   |
| A   | 0.425     | 0.435 | 10.80       | 11.04 |
| B   | 0.295     | 0.305 | 7.50        | 7.74  |
| C   | 0.095     | 0.105 | 2.42        | 2.66  |
| D   | 0.020     | 0.026 | 0.51        | 0.66  |
| F   | 0.115     | 0.130 | 2.93        | 3.30  |
| G   | 0.094 BSC |       | 2.39 BSC    |       |
| H   | 0.050     | 0.095 | 1.27        | 2.41  |
| J   | 0.015°    | 0.025 | 0.39°       | 0.63  |
| K   | 0.575     | 0.655 | 14.61       | 16.63 |
| M   | 5 TYP     |       | 5 TYP       |       |
| Q   | 0.148     | 0.158 | 3.76        | 4.01  |
| R   | 0.045     | 0.065 | 1.15        | 1.65  |
| S   | 0.025     | 0.035 | 0.64        | 0.88  |
| U   | 0.145     | 0.155 | 3.69        | 3.93  |
| V   | 0.040     | ---   | 1.02        | ---   |

1. DIMENSIONING AND TOLERANCING PER ANSI Y14.5M, 1982.
2. CONTROLLING DIMENSION: INCH.

### Part Marking System

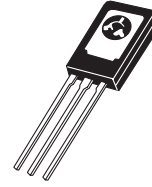

TO-225AA  
CASE 077  
STYLE 2



Y= Year  
WW = Work Week  
C106xx = Device Code  
xx = B, D, D1, M, M1  
G= Pb-Free Package

### Pin Assignment

|   |         |
|---|---------|
| 1 | Cathode |
| 2 | Anode   |
| 3 | Gate    |

### Ordering Information

| Device   | Package              | Shipping      |
|----------|----------------------|---------------|
| C106BG   | TO225AA<br>(Pb-Free) | 500 Units/Box |
| C106DG   |                      |               |
| C106D1G* |                      |               |
| C106MG   |                      |               |
| C106M1G* |                      |               |

\*D1 signifies European equivalent for D suffix and M1 signifies European equivalent for M suffix.

**Disclaimer Notice** - Information furnished is believed to be accurate and reliable. However, users should independently evaluate the suitability of and test each product selected for their own applications. Littelfuse products are not designed for, and may not be used in, all applications. Read complete Disclaimer Notice at: [www.littelfuse.com/disclaimer-electronics](http://www.littelfuse.com/disclaimer-electronics)