

SPECIFICATIONS

ELECTRICAL
 3PH AC Line Filter
 line voltage 500V (+10%)
 input current 6A @ 40°C
 operating frequency 50/60Hz
 voltage withstand 2150Vdc 1s
 insulation resistance 500Vdc 2 MOhm
 leakage current <37mA fault
 <1.5mA running
 watts dissipation 3.5W

MECHANICAL
 ingress protection IP20
 mass unpackaged 650g
 aluminium enclosure
 mounting centres (see drawing)
 terminal connection 6sqmm
 terminal earthing M5 stud
 terminal torque 7lbin (0.8Nm)

ENVIRONMENT
 humidity 90% RH (Non-condensing)
 pollution class II
 temperature -25/+100°C
 vibration 10-200Hz 1.8G

APPROVALS
 EN60939-1, EN60950, EN50178,
 EN61010-1
 UL1283 5th EDITION
 C22.2 No8

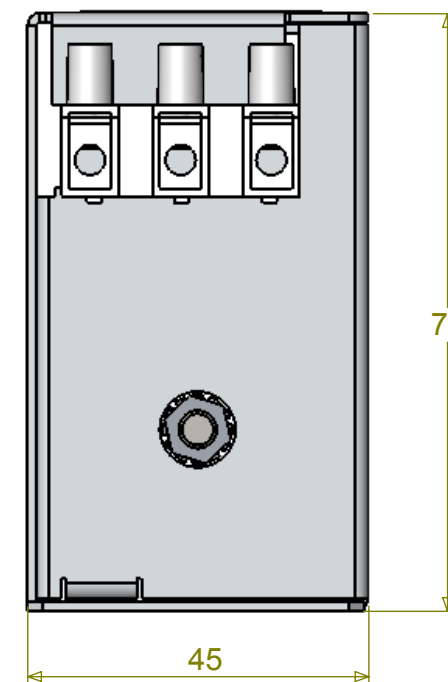
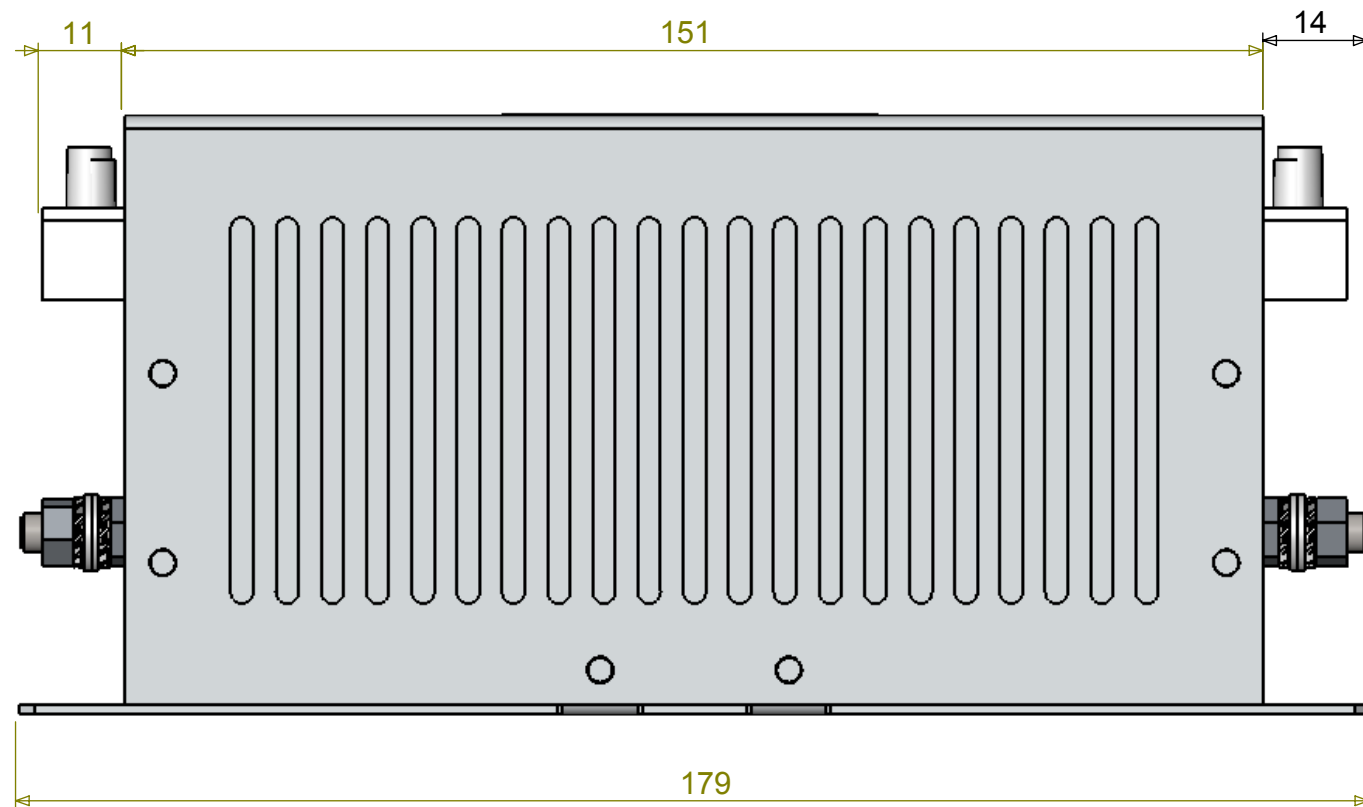

FINISH	DEBURR AND BREAK SHARP EDGES	DRAWN BY	SPB	TITLE	GENERAL SPECIFICATION FOR KMF306A	
		APPROVED BY	SW			
IF IN DOUBT ASK DO NOT SCALE DRAWING			THIRD ANGLE PROJECTION	SHEET 1 OF 1	DRAWING NO.	ISSUE
MATERIAL			A3	SCALE 1:1	KMF306A	04
						Release