

ISL21007

Precision, Low Noise FGA Voltage References

FN6326
Rev.12.00
Jun 9, 2017

The [ISL21007](#) FGA™ voltage references are extremely low power, high precision, and low noise voltage references fabricated on Intersil's proprietary Floating Gate Analog (FGA) technology. The ISL21007 features very low noise ($4.5\mu\text{V}_{\text{P-P}}$ for 0.1Hz to 10Hz) and very low operating current ($150\mu\text{A}$, Max). In addition, the ISL21007 family features guaranteed initial accuracy as low as $\pm 0.5\text{mV}$.

This combination of high initial accuracy, low drift, and low output noise performance of the ISL21007 enables versatile high performance control and data acquisition applications with low power consumption.

Applications

- High Resolution A/Ds and D/As
- Digital Meters
- Bar Code Scanners
- Base Stations
- Battery Management/Monitoring
- Industrial/Instrumentation Equipment

Features

- Reference Output Voltage 1.250V, 2.048V, 2.500V, 3.000V
- Input Voltage Range
ISL21007-12, 20, 25. 2.7V to 5.5V
ISL21007-30. 3.2V to 5.5V
- Low Output Voltage Noise. $4.5\mu\text{V}_{\text{P-P}}$ (0.1Hz to 10Hz)
- Supply Current $150\mu\text{A}$ (Max)
- Temperature Coefficient 3ppm/°C (B grade)
- Operating Temperature Range. -40°C to $+125^\circ\text{C}$
- Package 8 Ld SOIC
- Pb-Free (RoHS Compliant)

Related Literature

- For a full list of related documents, visit our website
- [ISL21007](#) product pages

TABLE 1. AVAILABLE OPTIONS

PART NUMBER	V _{OUT} OPTION (V)	INITIAL ACCURACY (mV)	TEMPCO. (ppm/°C)
ISL21007BFB812Z (Obsolete. Recommended replacement part ISL21007CFB812Z)	1.250	±0.5	3
ISL21007CFB812Z	1.250	±1.0	5
ISL21007DFB812Z	1.250	±2.0	10
ISL21007BFB820Z (Obsolete. Recommended replacement part ISL21007CFB820Z)	2.048	±0.5	3
ISL21007CFB820Z	2.048	±1.0	5
ISL21007DFB820Z (Obsolete. Recommended replacement ISL21007CFB820Z)	2.048	±2.0	10
ISL21007BFB825Z (Obsolete. Recommended replacement part ISL21007CFB825Z)	2.500	±0.5	3
ISL21007CFB825Z	2.500	±1.0	5
ISL21007DFB825Z	2.500	±2.0	10
ISL21007BFB830Z (Obsolete. Recommended replacement ISL21007CFB825Z-TK)	3.000	±0.5	3
ISL21007CFB830Z (Obsolete. Recommended replacement ISL21007CFB825Z-TK)	3.000	±1.0	5
ISL21007DFB830Z (Obsolete. Recommended replacement ISL21007CFB825Z-TK)	3.000	±2.0	10

Ordering Information

PART NUMBER (Notes 1, 2, 3)	PART MARKING	V _{OUT} OPTION (V)	GRADE	TEMP. RANGE (°C)	PACKAGE (RoHS COMPLIANT)	PKG. DWG. #
ISL21007CFB812Z	21007CF Z12	1.250	±1.0mV, 5ppm/°C	-40 to +125	8 Ld SOIC	M8.15
ISL21007DFB812Z	21007DF Z12	1.250	±2.0mV, 10ppm/°C	-40 to +125	8 Ld SOIC	M8.15
ISL21007CFB820Z	21007CF Z20	2.048	±1.0mV, 5ppm/°C	-40 to +125	8 Ld SOIC	M8.15
ISL21007DFB820Z (Obsolete recommended replacement ISL21007CFB820Z)	21007DF Z20	2.048	±2.0mV, 10ppm/°C	-40 to +125	8 Ld SOIC	M8.15
ISL21007CFB825Z	21007CF Z25	2.500	±1.0mV, 5ppm/°C	-40 to +125	8 Ld SOIC	M8.15
ISL21007DFB825Z	21007DF Z25	2.500	±2.0mV, 10ppm/°C	-40 to +125	8 Ld SOIC	M8.15
ISL21007CFB830Z (Obsolete, recommended replacement ISL21007CFB825Z-TK)	21007CF Z30	3.000	±1.0mV, 5ppm/°C	-40 to +125	8 Ld SOIC	M8.15
ISL21007DFB830Z (Obsolete, recommended replacement ISL21007CFB825Z-TK)	21007DF Z30	3.000	±2.0mV, 10ppm/°C	-40 to +125	8 Ld SOIC	M8.15

NOTES:

- These Intersil Pb-free plastic packaged products employ special Pb-free material sets, molding compounds/die attach materials, and 100% matte tin plate plus anneal (e3 termination finish, which is RoHS compliant and compatible with both SnPb and Pb-free soldering operations). Intersil Pb-free products are MSL classified at Pb-free peak reflow temperatures that meet or exceed the Pb-free requirements of IPC/JEDEC J STD-020.
- Add "-TK" suffix for 1k unit tape and reel option. Refer to [TB347](#) for details on reel specifications.
- For Moisture Sensitivity Level (MSL), see device information pages for [ISL21007CFB812](#), [ISL21007CFB820](#), [ISL21007CFB825](#), [ISL21007CFB830](#), [ISL21007DFB812](#), [ISL21007DFB820](#), [ISL21007DFB825](#), [ISL21007DFB830](#). For more information on MSL, see techbrief [TB363](#).

Pin Configuration

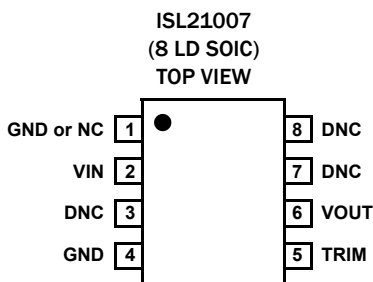

Pin Descriptions

PIN NUMBER	PIN NAME	DESCRIPTION
1	GND or NC	Ground or No Connection
2	VIN	Power Supply Input Connection
4	GND	Ground
5	TRIM	Allows User Trim V _{OUT} ±2.5%
6	VOUT	Voltage Reference Output Connection
3, 7, 8	DNC	Do Not Connect; Internal Connection - Must Be Left Floating

Typical Application Circuit

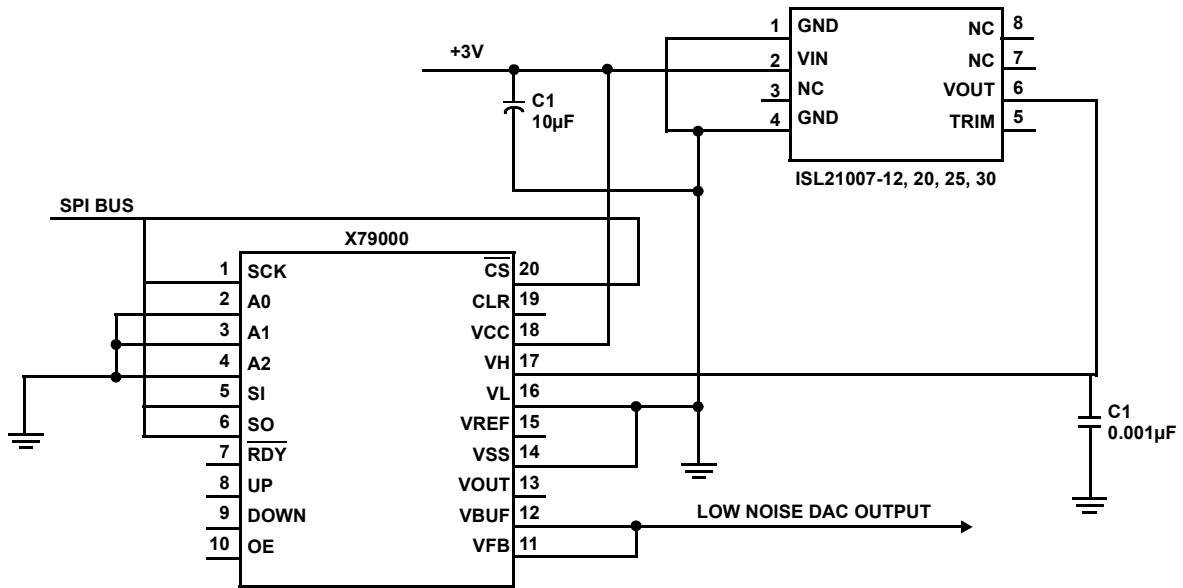

FIGURE 1. TYPICAL APPLICATION PRECISION 12-BIT SUBRANGING DAC

Absolute Voltage Ratings

Storage Temperature Range	-65 °C to +150 °C
Max Voltage VIN to GND	-0.5V to +6.5V
Max Voltage VOUT to GND (10s)	-0.5V to V _{OUT} + 1
Voltage on "DNC" pins	No connections permitted to these pins.
ESD Rating	
Human Body Model (HBM)	6kV
Machine Model (MM)	600V
Charged Device Model (CDM)	2kV

Environmental Operating Conditions

X-Ray Exposure (Note 4) 10mRem

CAUTION: Do not operate at or near the maximum ratings listed for extended periods of time. Exposure to such conditions may adversely impact product reliability and result in failures not covered by warranty.

IMPORTANT NOTE: All parameters having Min/Max specifications are guaranteed. Typ values are for information purposes only. Unless otherwise noted, all tests are at the specified temperature and are pulsed tests, therefore: $T_J = T_C = T_A$

NOTES:

- Measured with no filtering, distance of 10" from source, intensity set to 55kV and 70mA current, 30s duration. Other exposure levels should be analyzed for Output Voltage drift effects. See "Applications Information" on page 16.
- θ_{JA} is measured with the component mounted on a high-effective thermal conductivity test board in free air. See tech brief TB379 for details.
- Post-reflow drift for the ISL21007 devices will range from 100 μ V to 1.0mV based on experimental results with devices on FR4 double sided boards. The design engineer must take this into account when considering the reference voltage after assembly.

Common Electrical Specifications (ISL21007-12, -20, -25, -30) $T_A = -40^\circ\text{C}$ to $+125^\circ\text{C}$, unless otherwise specified. Boldface limits apply across the operating temperature range, -40°C to $+125^\circ\text{C}$.

PARAMETER	SYMBOL	CONDITIONS	MIN (Note 10)	TYP	MAX (Note 10)	UNIT
V _{OUT} Accuracy at $T_A = +25^\circ\text{C}$	V _{OA}	ISL21007B	-0.5		+0.5	mV
		ISL21007C	-1.0		+1.0	mV
		ISL21007D	-2.0		+2.0	mV
Output Voltage Temperature Coefficient (Note 7)	TC V _{OUT}	ISL21007B			3	ppm/°C
		ISL21007C			5	ppm/°C
		ISL21007D			10	ppm/°C
Supply Current	I _{IN}			75	150	μ A
Trim Range			± 2.0	± 2.5		%
Turn-On Settling Time	t _R	V _{OUT} = $\pm 0.1\%$		120		μ s
Ripple Rejection		f = 10kHz		60		dB
Output Voltage Noise	e _N	0.1Hz \leq f \leq 10Hz		4.5		μ V _{P-P}
Broadband Voltage Noise	V _N	10Hz \leq f \leq 1kHz		2.2		μ V _{RMS}
Noise Density		f = 1kHz		60		nV/ $\sqrt{\text{Hz}}$

Thermal Information

Thermal Resistance (Typical, Note 5)	θ_{JA} (°C/W)
8 Ld SOIC	113.12
Continuous Power Dissipation (Note 5)	$T_A = +70^\circ\text{C}$
8 Ld SOIC Derate 5.88mW/°C above +70°C	471mW
Pb-Free Reflow Profile (Note 6)	see TB493

Recommended Operating Conditions

Temperature Range (Full Range Industrial) -40°C to $+125^\circ\text{C}$

Electrical Specifications (ISL21007-12, $V_{OUT} = 1.250V$) $V_{IN} = 3.0V$, $T_A = -40^\circ C$ to $+125^\circ C$, unless otherwise specified. **Boldface limits apply across the operating temperature range, $-40^\circ C$ to $+125^\circ C$.**

PARAMETER	SYMBOL	CONDITIONS	MIN (Note 10)	TYP	MAX (Note 10)	UNIT
Input Voltage Range	V_{IN}		2.7		5.5	V
Output Voltage	V_{OUT}			1.250		V
Line Regulation	$\Delta V_{OUT}/\Delta V_{IN}$	$2.7V \leq V_{IN} \leq 5.5V$		100	700	$\mu V/V$
Load Regulation	$\Delta V_{OUT}/\Delta I_{OUT}$	Sourcing: $0mA \leq I_{OUT} \leq 7mA$		10	100	$\mu V/mA$
		Sinking: $-7mA \leq I_{OUT} \leq 0mA$		20	150	$\mu V/mA$
Short-Circuit Current	I_{SC}	$T_A = +25^\circ C$, V_{OUT} tied to GND		40		mA
Thermal Hysteresis (Note 8)	$\Delta V_{OUT}/\Delta T_A$	$\Delta T_A = +165^\circ C$		50		ppm
Long Term Stability (Note 9)	$\Delta V_{OUT}/\Delta t$	$T_A = +25^\circ C$		100		ppm

Electrical Specifications (ISL21007-20, $V_{OUT} = 2.048V$) $V_{IN} = 3.0V$, $T_A = -40^\circ C$ to $+125^\circ C$, unless otherwise specified. **Boldface limits apply across the operating temperature range, $-40^\circ C$ to $+125^\circ C$.**

PARAMETER	SYMBOL	CONDITIONS	MIN (Note 10)	TYP	MAX (Note 10)	UNIT
Input Voltage Range	V_{IN}		2.7		5.5	V
Output Voltage	V_{OUT}			2.048		V
Line Regulation	$\Delta V_{OUT}/\Delta V_{IN}$	$2.7V \leq V_{IN} \leq 5.5V$		50	200	$\mu V/V$
Load Regulation	$\Delta V_{OUT}/\Delta I_{OUT}$	Sourcing: $0mA \leq I_{OUT} \leq 7mA$		10	100	$\mu V/mA$
		Sinking: $-7mA \leq I_{OUT} \leq 0mA$		20	150	$\mu V/mA$
Short-Circuit Current	I_{SC}	$T_A = +25^\circ C$, V_{OUT} tied to GND		50		mA
Thermal Hysteresis (Note 8)	$\Delta V_{OUT}/\Delta T_A$	$\Delta T_A = +165^\circ C$		50		ppm
Long Term Stability (Note 9)	$\Delta V_{OUT}/\Delta t$	$T_A = +25^\circ C$		75		ppm

Electrical Specifications (ISL21007-25, $V_{OUT} = 2.500V$) $V_{IN} = 3.0V$, $T_A = -40^\circ C$ to $+125^\circ C$, unless otherwise specified. **Boldface limits apply across the operating temperature range, $-40^\circ C$ to $+125^\circ C$.**

PARAMETER	SYMBOL	CONDITIONS	MIN (Note 10)	TYP	MAX (Note 10)	UNIT
Input Voltage Range	V_{IN}		2.7		5.5	V
Output Voltage	V_{OUT}			2.500		V
Line Regulation	$\Delta V_{OUT}/\Delta V_{IN}$	$2.7V \leq V_{IN} \leq 5.5V$		50	200	$\mu V/V$
Load Regulation	$\Delta V_{OUT}/\Delta I_{OUT}$	Sourcing: $0mA \leq I_{OUT} \leq 5mA$		10	100	$\mu V/mA$
		Sinking: $-5mA \leq I_{OUT} \leq 0mA$		20	150	$\mu V/mA$
Short-Circuit Current	I_{SC}	$T_A = +25^\circ C$, V_{OUT} tied to GND		50		mA
Thermal Hysteresis (Note 8)	$\Delta V_{OUT}/\Delta T_A$	$\Delta T_A = +165^\circ C$		50		ppm
Long Term Stability (Note 9)	$\Delta V_{OUT}/\Delta t$	$T_A = +25^\circ C$		50		ppm

Electrical Specifications (ISL21007-30, $V_{OUT} = 3.000V$) $V_{IN} = 5.0V, T_A = -40^{\circ}C$ to $+125^{\circ}C$, unless otherwise specified.
Boldface limits apply over the operating temperature range, $-40^{\circ}C$ to $+125^{\circ}C$.

PARAMETER	SYMBOL	CONDITIONS	MIN (Note 10)	TYP	MAX (Note 10)	UNIT
Input Voltage Range	V_{IN}		3.2		5.5	V
Output Voltage	V_{OUT}			3.000		V
Line Regulation	$\Delta V_{OUT} / \Delta V_{IN}$	$3.2V \leq V_{IN} \leq 5.5V$		50	200	$\mu V/V$
Load Regulation	$\Delta V_{OUT} / \Delta I_{OUT}$	Sourcing: $0mA \leq I_{OUT} \leq 7mA$		10	100	$\mu V/mA$
		Sinking: $-7mA \leq I_{OUT} \leq 0mA$		20	150	$\mu V/mA$
Short-Circuit Current	I_{SC}	$T_A = +25^{\circ}C, V_{OUT}$ tied to GND		50		mA
Thermal Hysteresis (Note 8)	$\Delta V_{OUT} / \Delta T_A$	$\Delta T_A = +165^{\circ}C$		50		ppm
Long Term Stability (Note 9)	$\Delta V_{OUT} / \Delta t$	$T_A = +25^{\circ}C$		50		ppm

NOTES:

- Over the specified temperature range. Temperature coefficient is measured by the box method whereby the change in V_{OUT} is divided by the temperature range; in this case, $-40^{\circ}C$ to $+125^{\circ}C = +165^{\circ}C$.
- Thermal Hysteresis is the change of V_{OUT} measured at $T_A = +25^{\circ}C$ after temperature cycling over a specified range, ΔT_A . V_{OUT} is read initially at $T_A = +25^{\circ}C$ for the device under test. The device is temperature cycled and a second V_{OUT} measurement is taken at $+25^{\circ}C$. The difference between the initial V_{OUT} reading and the second V_{OUT} reading is then expressed in ppm. For $\Delta T_A = +165^{\circ}C$, the device under test is cycled from $+25^{\circ}C$ to $+125^{\circ}C$ to $-40^{\circ}C$ to $+25^{\circ}C$.
- Long term drift is logarithmic in nature and diminishes over time. Drift after the first 1000 hours will be approximately $10ppm/\sqrt{(1kHrs)}$.
- Compliance to datasheet limits is assured by one or more methods: production test, characterization, and/or design.

Typical Performance Curves (ISL21007-12) ($R_{EXT} = 100k\Omega$)

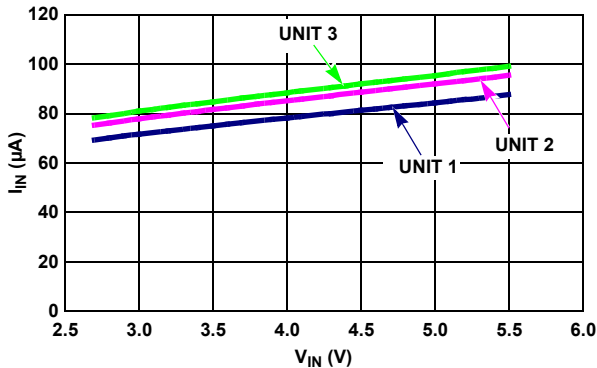

FIGURE 2. I_{IN} vs V_{IN} (3 UNITS)

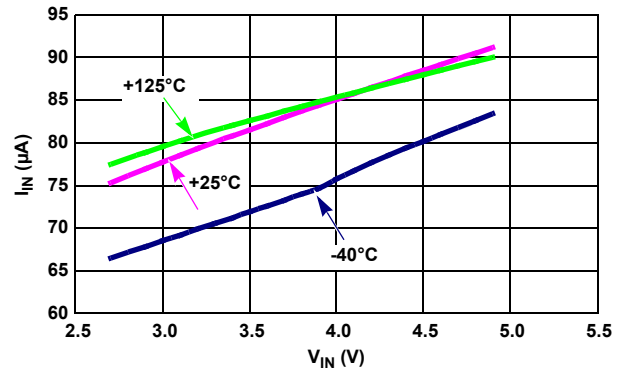

FIGURE 3. I_{IN} vs V_{IN} OVER TEMPERATURE

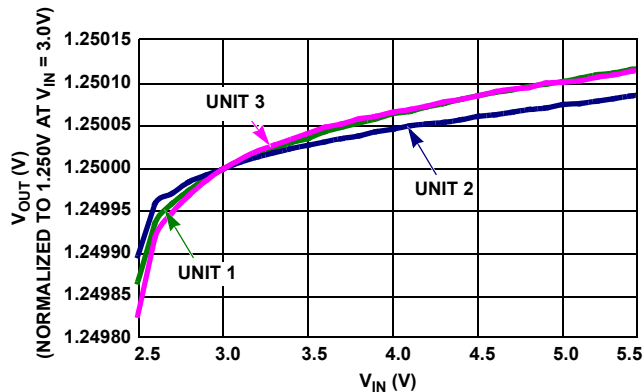

FIGURE 4. LINE REGULATION (3 UNITS)

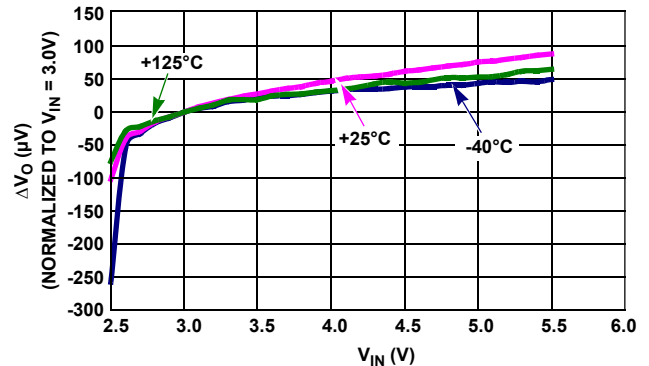

FIGURE 5. LINE REGULATION OVER TEMPERATURE

Typical Performance Curves (ISL21007-12) ($R_{EXT} = 100k\Omega$) (Continued)

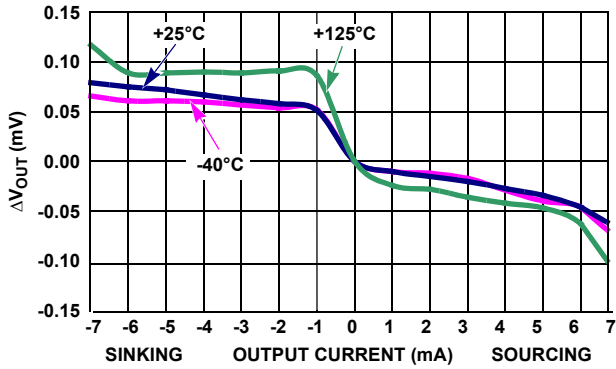

FIGURE 6. LOAD REGULATION OVER TEMPERATURE

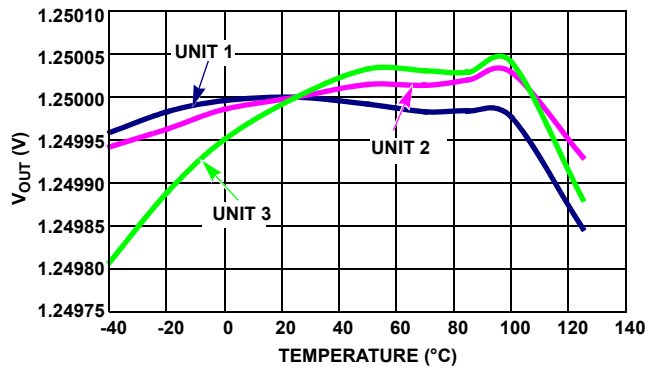

FIGURE 7. V_{OUT} vs TEMPERATURE (3 UNITS)

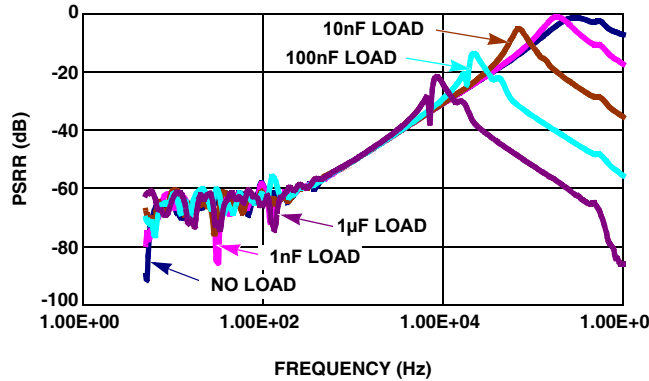

FIGURE 8. PSRR vs CAPACITIVE LOADS

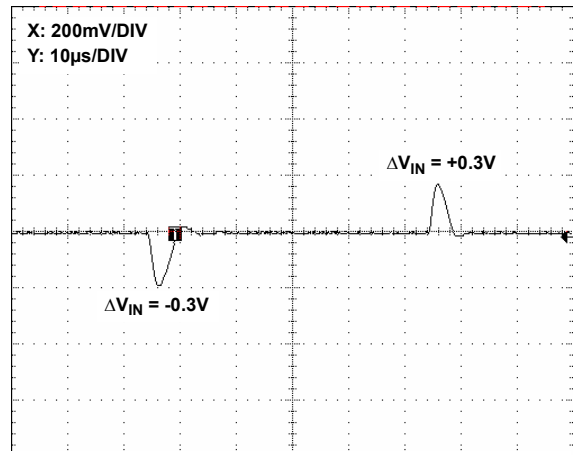

FIGURE 9. LINE TRANSIENT RESPONSE, NO CAPACITIVE LOAD

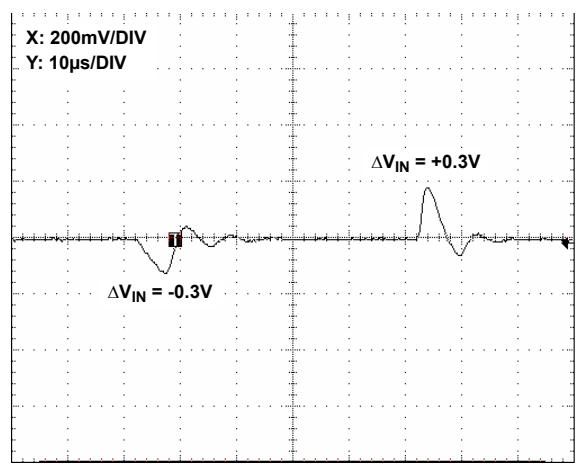

FIGURE 10. LINE TRANSIENT RESPONSE, 0.001μF LOAD CAPACITANCE

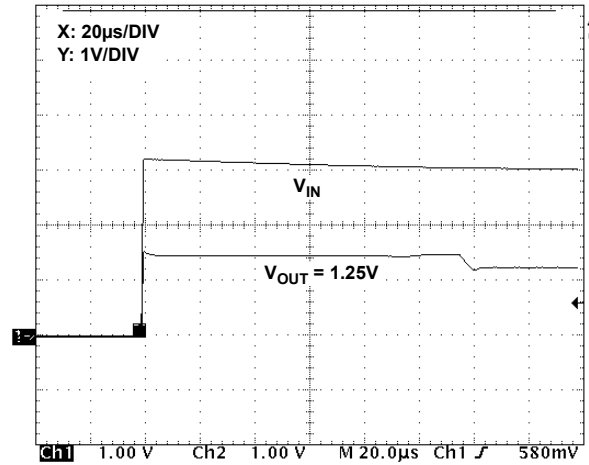

FIGURE 11. TURN-ON TIME

Typical Performance Curves (ISL21007-12) ($R_{EXT} = 100k\Omega$) (Continued)

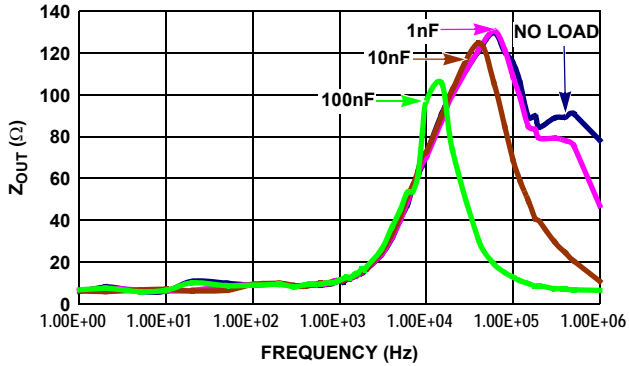

FIGURE 12. Z_{OUT} vs FREQUENCY

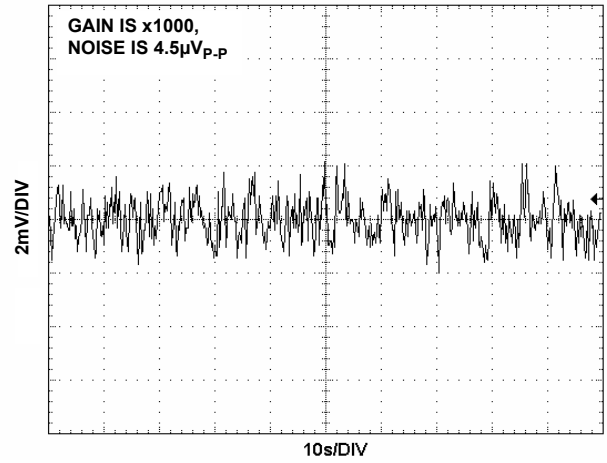

FIGURE 13. V_{OUT} NOISE, 0.1Hz TO 10Hz

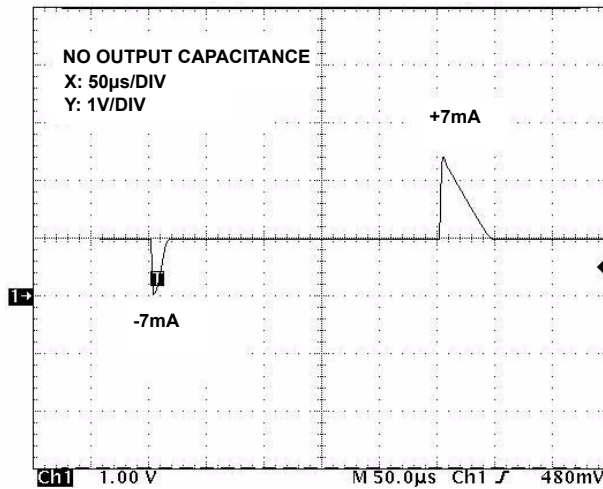

FIGURE 14. LOAD TRANSIENT RESPONSE

Typical Performance Curves (ISL21007-20) ($R_{EXT} = 100k\Omega$)

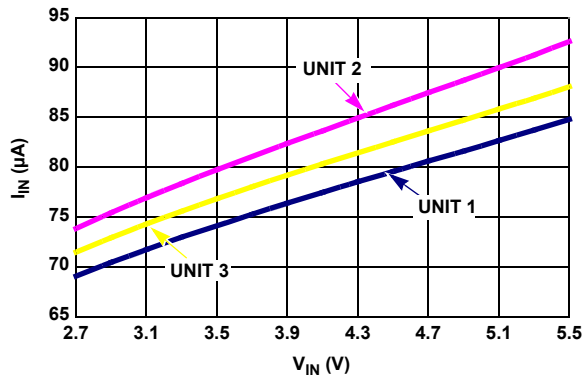

FIGURE 15. I_{IN} vs V_{IN} (3 UNITS)

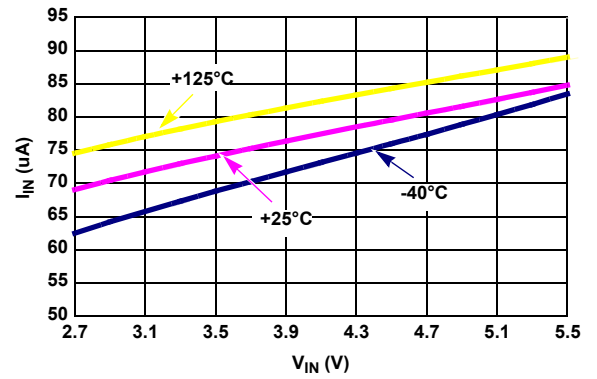

FIGURE 16. I_{IN} vs V_{IN} OVER TEMPERATURE

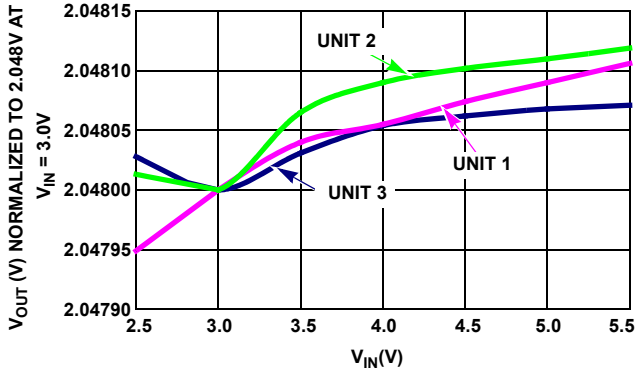

FIGURE 17. LINE REGULATION (3 UNITS)

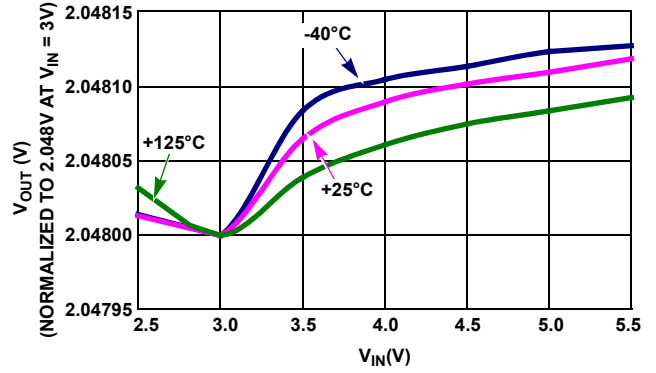

FIGURE 18. LINE REGULATION OVER TEMPERATURE

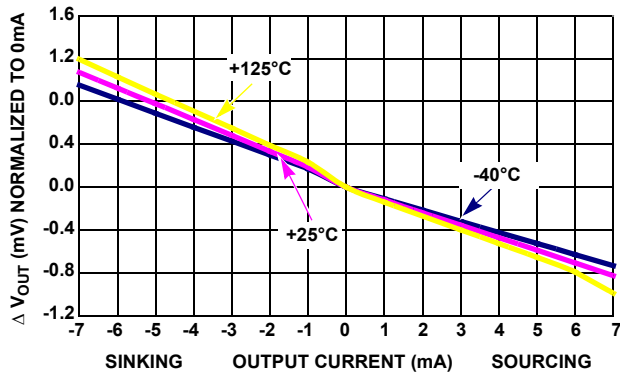

FIGURE 19. LOAD REGULATION OVER TEMPERATURE

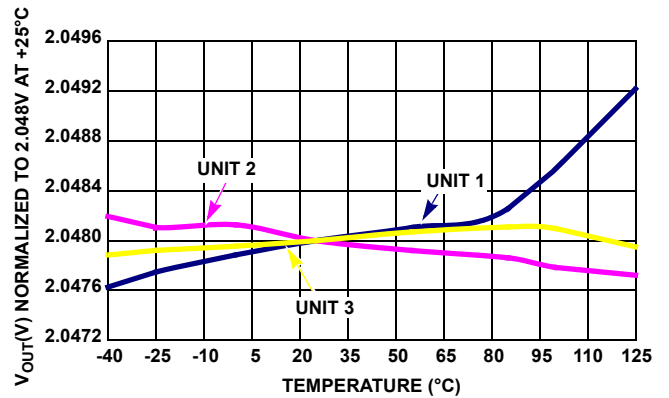

FIGURE 20. V_{OUT} vs TEMPERATURE (3 UNITS)

Typical Performance Curves (ISL21007-20) ($R_{EXT} = 100k\Omega$) (Continued)

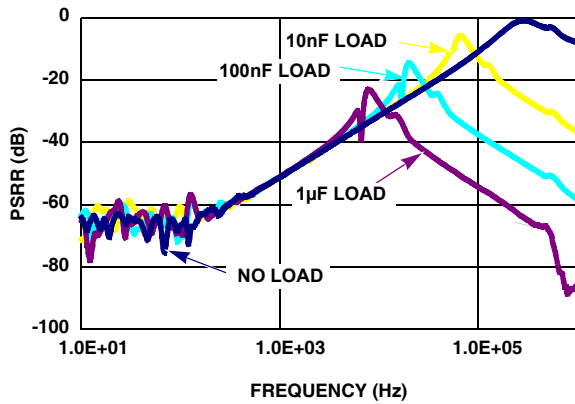

FIGURE 21. PSRR vs CAPACITIVE LOADS

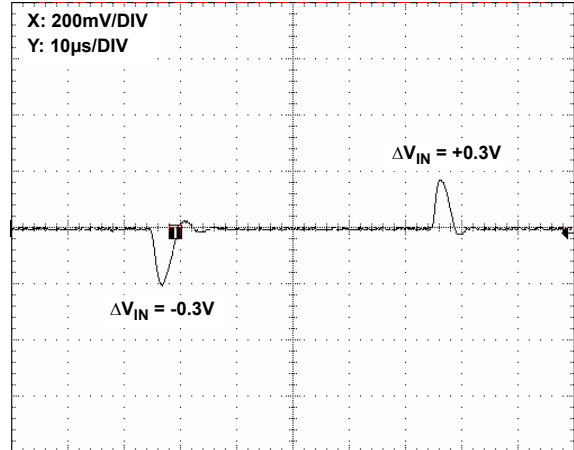

FIGURE 22. LINE TRANSIENT RESPONSE, NO CAPACITIVE LOAD

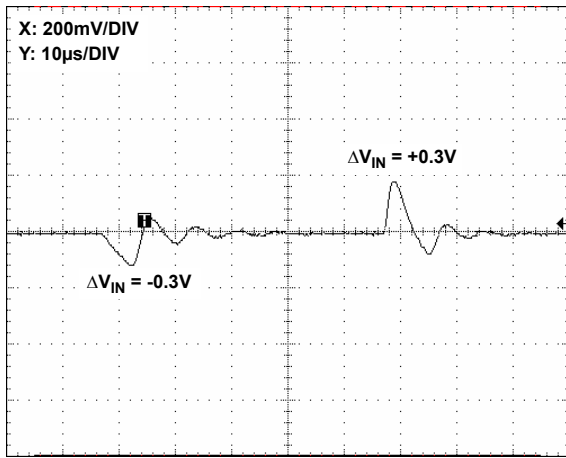

FIGURE 23. LINE TRANSIENT RESPONSE, 0.001μF LOAD CAPACITANCE

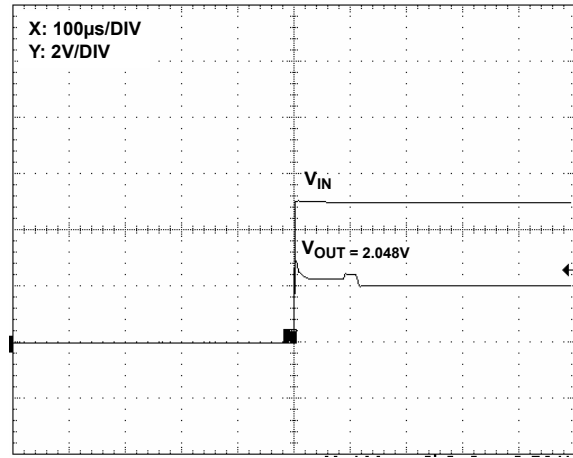

FIGURE 24. TURN-ON TIME

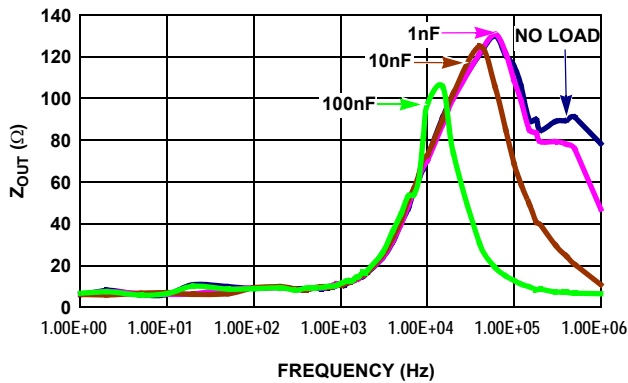

FIGURE 25. Z_{OUT} VS FREQUENCY

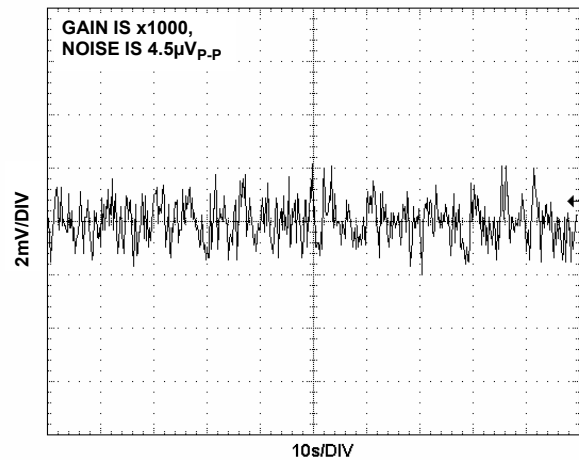

FIGURE 26. V_{OUT} NOISE, 0.1Hz TO 10Hz

Typical Performance Curves (ISL21007-20) ($R_{EXT} = 100k\Omega$) (Continued)

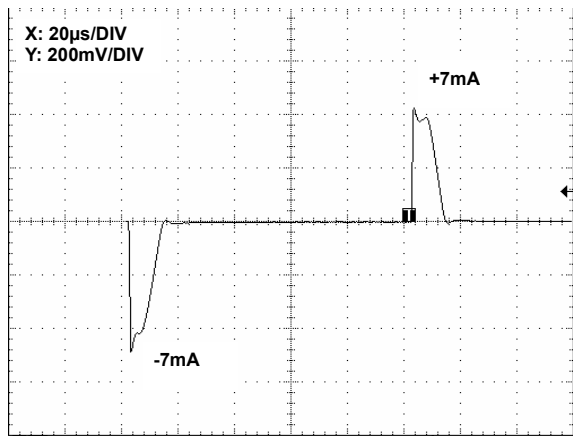

FIGURE 27. LOAD TRANSIENT RESPONSE, 0.001µF LOAD CAPACITANCE

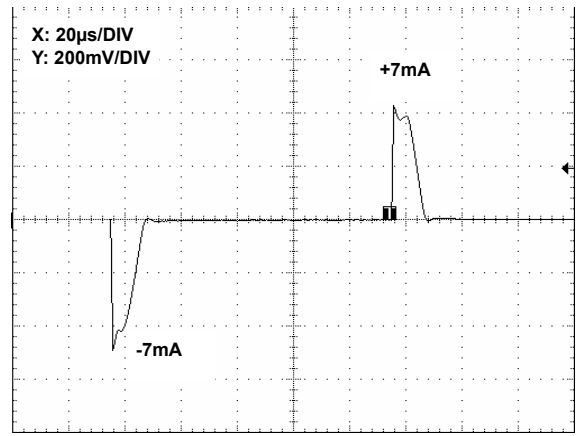

FIGURE 28. LOAD TRANSIENT RESPONSE, NO CAPACITIVE LOAD

Typical Performance Curves (ISL21007-25) ($R_{EXT} = 100k\Omega$)

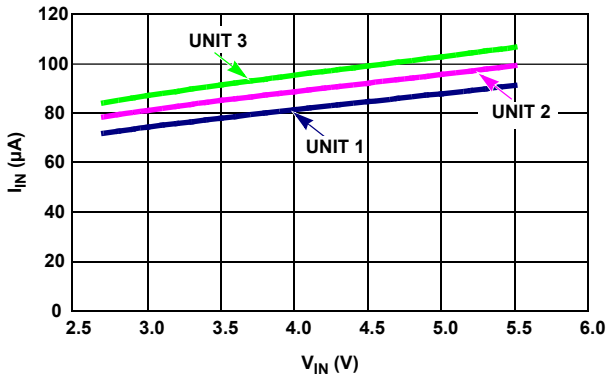

FIGURE 29. I_{IN} vs V_{IN} (3 UNITS)

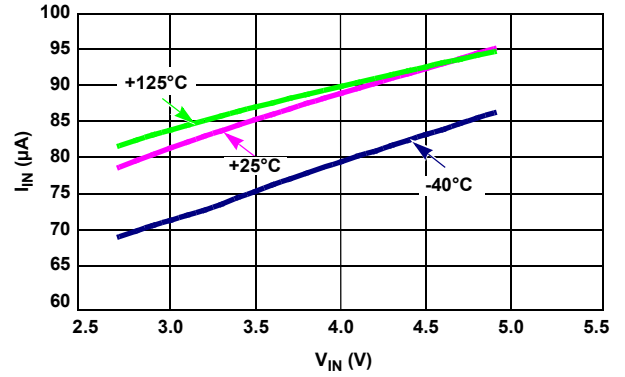

FIGURE 30. I_{IN} vs V_{IN} OVER TEMPERATURE

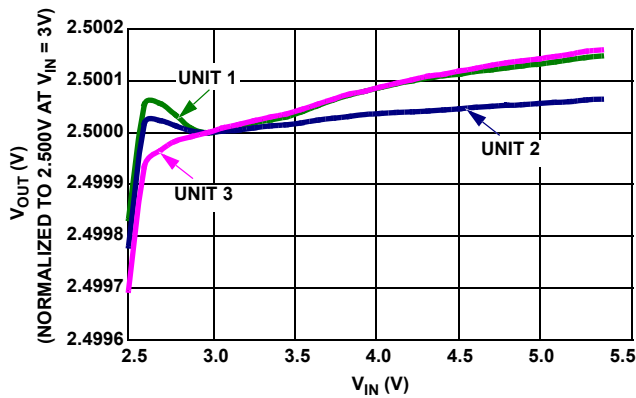

FIGURE 31. LINE REGULATION (3 UNITS)

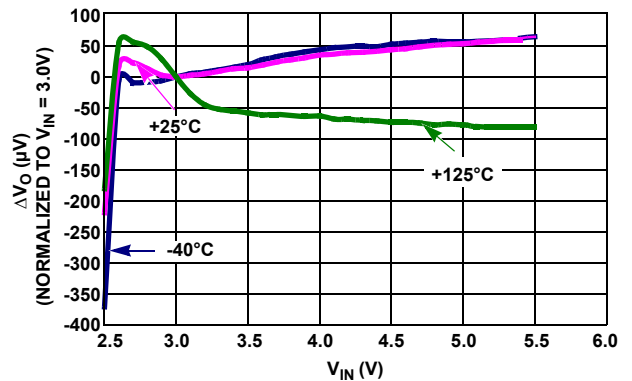

FIGURE 32. LINE REGULATION OVER TEMPERATURE

Typical Performance Curves (ISL21007-25) ($R_{EXT} = 100k\Omega$) (Continued)

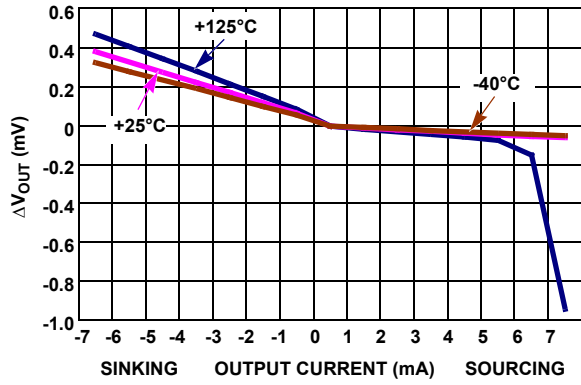

FIGURE 33. LOAD REGULATION OVER TEMPERATURE

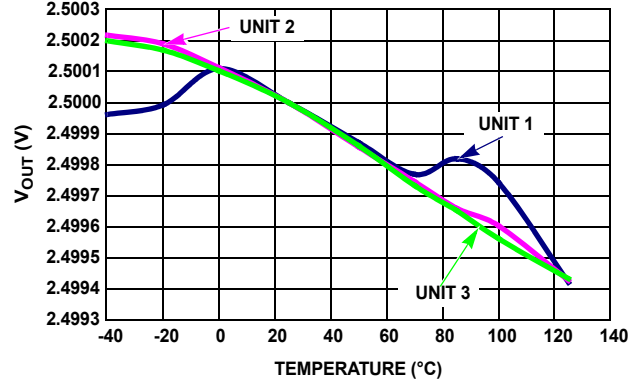

FIGURE 34. V_{OUT} vs TEMPERATURE (3 UNITS)

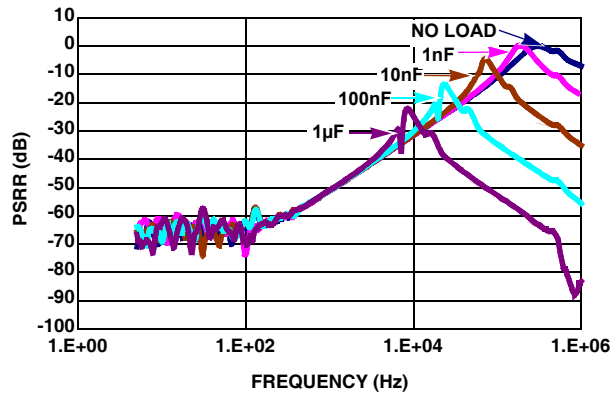

FIGURE 35. PSRR vs CAPACITIVE LOADS

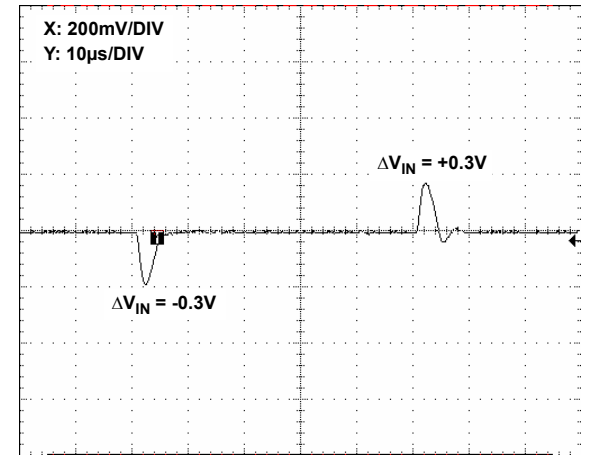

FIGURE 36. LINE TRANSIENT RESPONSE, NO CAPACITIVE LOAD

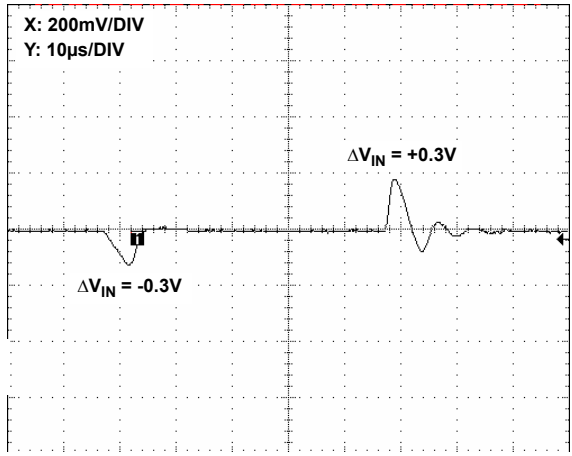

FIGURE 37. LINE TRANSIENT RESPONSE, 0.001μF LOAD CAPACITANCE

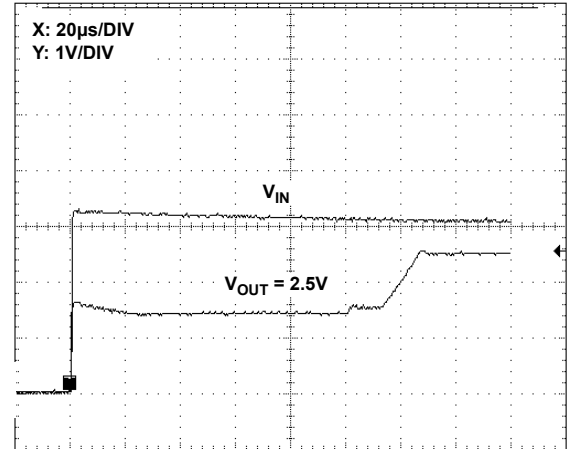

FIGURE 38. TURN-ON TIME

Typical Performance Curves (ISL21007-25) ($R_{EXT} = 100k\Omega$) (Continued)

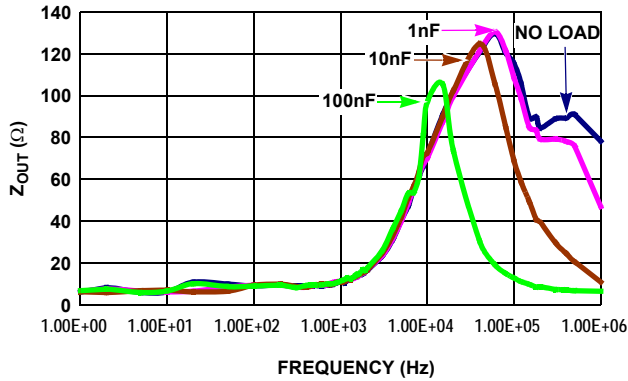

FIGURE 39. Z_{OUT} vs FREQUENCY

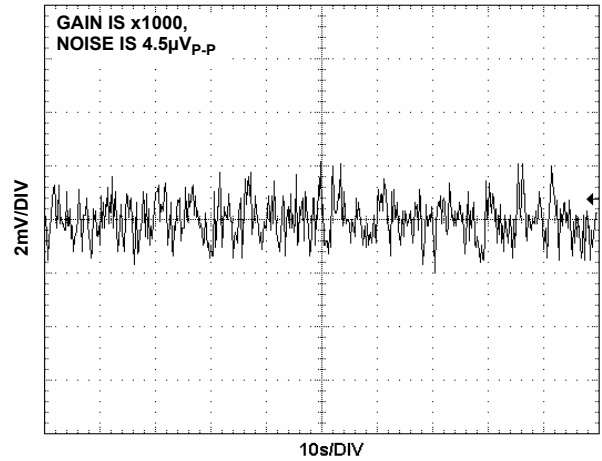

FIGURE 40. V_{OUT} NOISE, 0.1Hz TO 10Hz

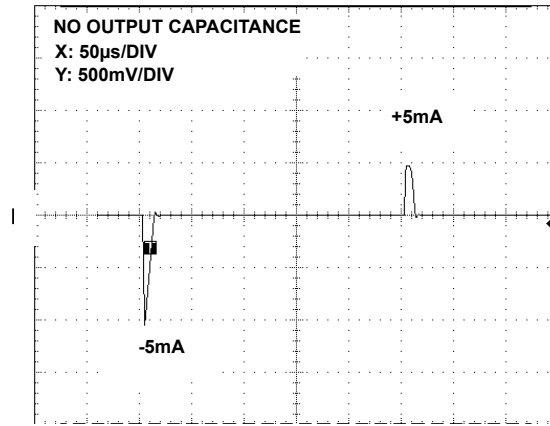

FIGURE 41. LOAD TRANSIENT RESPONSE

Typical Performance Curves (ISL21007-30) ($R_{EXT} = 100k\Omega$)

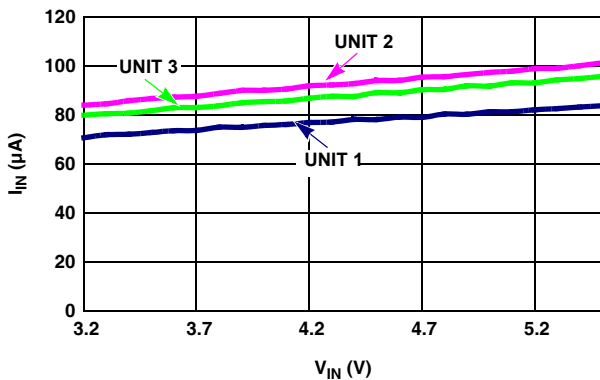

FIGURE 42. I_{IN} vs V_{IN} (3 UNITS)

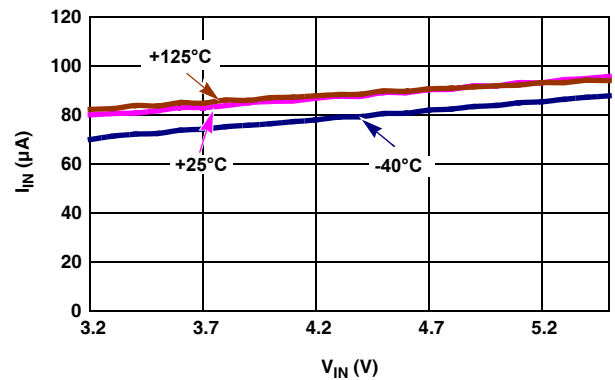

FIGURE 43. I_{IN} vs V_{IN} OVER TEMPERATURE

Typical Performance Curves (ISL21007-30) ($R_{EXT} = 100k\Omega$) (Continued)

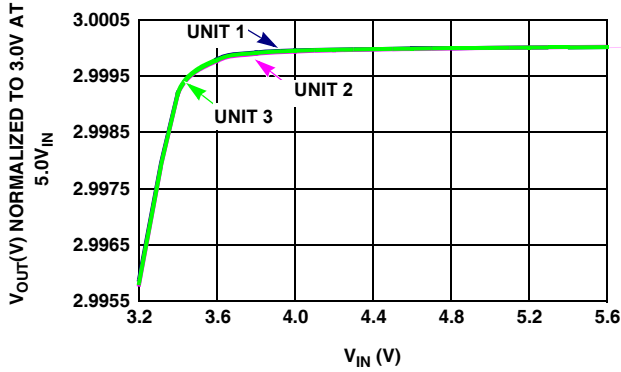

FIGURE 44. LINE REGULATION (3 UNITS)

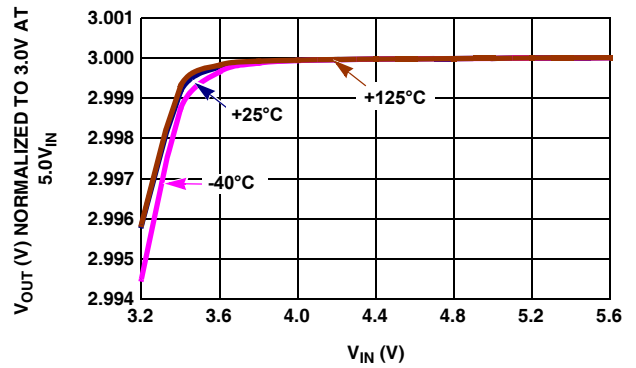

FIGURE 45. LINE REGULATION OVER TEMPERATURE

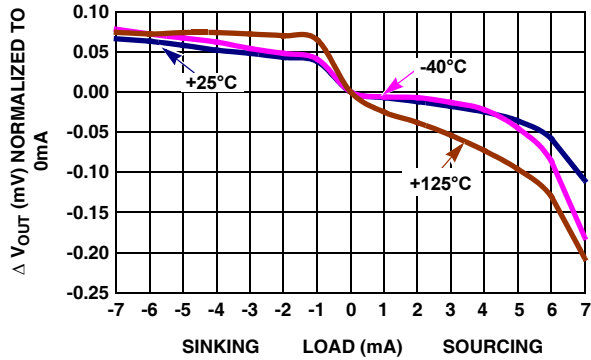

FIGURE 46. LOAD REGULATION OVER TEMPERATURE

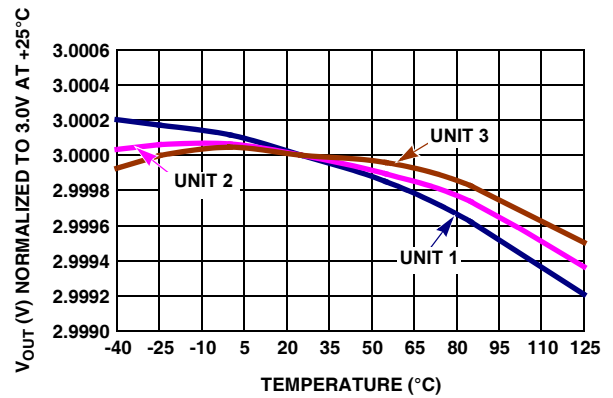

FIGURE 47. V_{OUT} vs TEMPERATURE (3 UNITS)

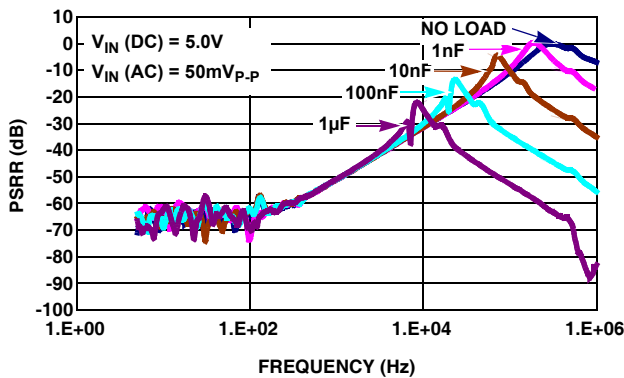

FIGURE 48. PSRR vs CAPACITIVE LOADS

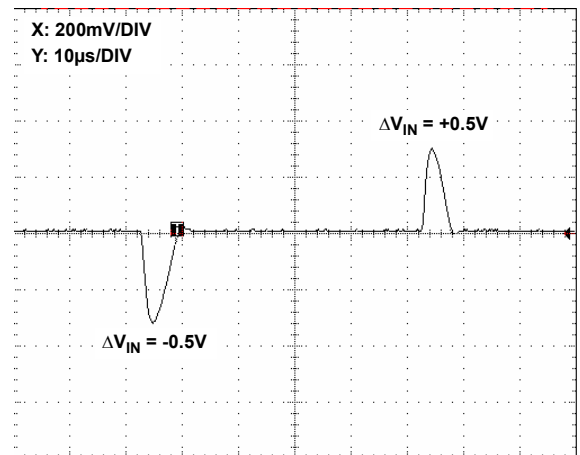

FIGURE 49. LINE TRANSIENT RESPONSE, NO CAPACITIVE LOAD

Typical Performance Curves (ISL21007-30) ($R_{EXT} = 100k\Omega$) (Continued)

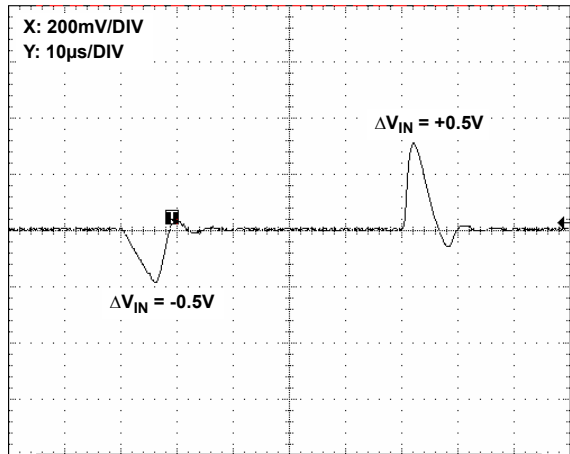

FIGURE 50. LINE TRANSIENT RESPONSE, 0.001µF LOAD CAPACITANCE

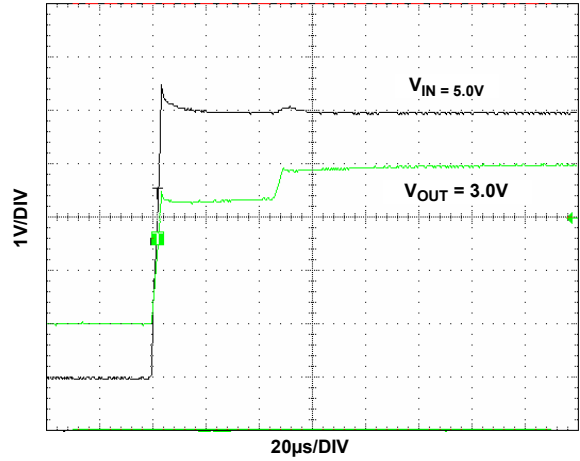

FIGURE 51. TURN-ON TIME

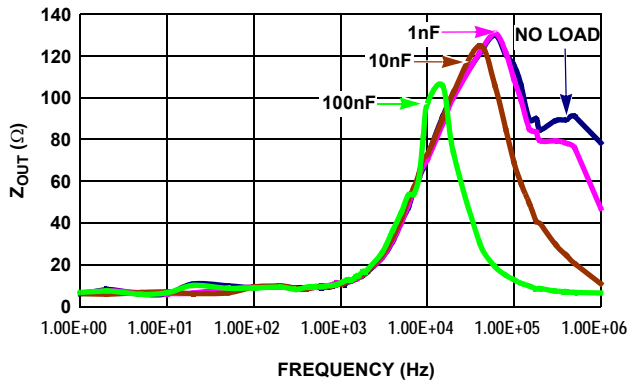

FIGURE 52. Z_{OUT} vs FREQUENCY

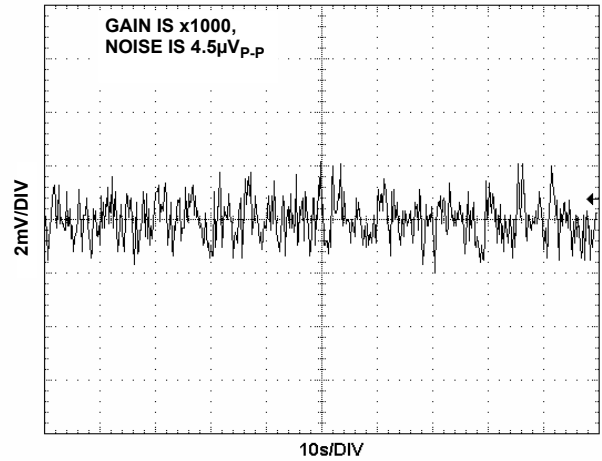

FIGURE 53. V_{OUT} NOISE, 0.1Hz TO 10Hz

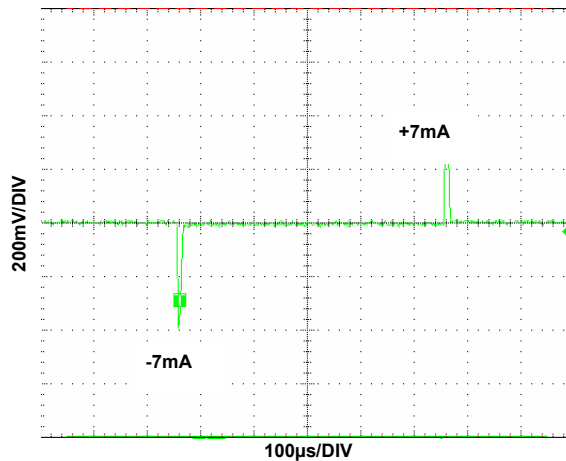

FIGURE 54. LOAD TRANSIENT RESPONSE

Applications Information

FGA Technology

The ISL21007 voltage reference uses floating gate technology to create references with very low drift and supply current.

Essentially, the charge stored on a floating gate cell is set precisely in manufacturing. The reference voltage output itself is a buffered version of the floating gate voltage. The resulting reference device has excellent characteristics that are unique in the industry: very low temperature drift, high initial accuracy, and almost zero supply current. Also, the reference voltage itself is not limited by voltage bandgaps or zener settings, so a wide range of reference voltages can be programmed (standard voltage settings are provided, but customer-specific voltages are available).

The process used for these reference devices is a floating gate CMOS process, and the amplifier circuitry uses CMOS transistors for amplifier and output transistor circuitry. While providing excellent accuracy, there are limitations in output noise level and load regulation due to the MOS device characteristics. These limitations are addressed with circuit techniques discussed in other sections.

Micropower Operation

The ISL21007 consumes extremely low supply current due to the proprietary FGA technology. Low noise performance is achieved using optimized biasing techniques. Supply current is typically 75 μ A and noise is 4.5 μ V_{p-p} benefitting precision, low noise portable applications such as handheld meters and instruments.

Data Converters in particular can use the ISL21007 as an external voltage reference. Low power DAC and ADC circuits will realize maximum resolution with lowest noise.

Handling and Board Mounting

FGA references provide excellent initial accuracy and low temperature drift at the expense of very little power drain. There are some precautions to take to ensure this accuracy is not compromised. Excessive heat during solder reflow can cause excessive initial accuracy drift, so the recommended +260 °C max temperature profile should not be exceeded. Expect up to 1mV drift from the solder reflow process.

FGA references are susceptible to excessive X-radiation like that used in PC board manufacturing. Initial accuracy can change 10mV or more under extreme radiation. If an assembled board needs to be X-rayed, care should be taken to shield the FGA reference device.

Board Mounting Considerations

For applications requiring the highest accuracy, board mounting location should be reviewed. Placing the device in areas subject to slight twisting can cause degradation of the accuracy of the reference voltage due to die stresses. It is normally best to place the device near the edge of a board, or the shortest side, as the axis of bending is most limited at that location. Obviously, mounting the device on flexprint or extremely thin PC material will likewise cause loss of reference accuracy.

Board Assembly Considerations

FGA references provide high accuracy and low temperature drift but some PC board assembly precautions are necessary. Normal Output voltage shifts of 100 μ V to 1mV can be expected with Pb-free reflow profiles or wave solder on multi-layer FR4 PC boards. Precautions should be taken to avoid excessive heat or extended exposure to high reflow or wave solder temperatures, this may reduce device initial accuracy.

Post-assembly X-ray inspection may also lead to permanent changes in device output voltage and should be minimized or avoided. If X-ray inspection is required, it is advisable to monitor the reference output voltage to verify excessive shift has not occurred. If large amounts of shift are observed, it is best to add an X-ray shield consisting of thin zinc (300 μ m) sheeting to allow clear imaging, yet block X-ray energy that affects the FGA reference.

Special Applications Considerations

In addition to post-assembly examination, there are also other X-ray sources that may affect the FGA reference long term accuracy. Airport screening machines contain X-rays and will have a cumulative effect on the voltage reference output accuracy. Carry-on luggage screening uses low level X-rays and is not a major source of output voltage shift, however, if a product is expected to pass through that type of screening over 100 times, it may need to consider shielding with copper or aluminum. Checked luggage X-rays are higher intensity and can cause output voltage shift in much fewer passes, thus devices expected to go through those machines should definitely consider shielding. Note that just two layers of 1/2 ounce copper planes will reduce the received dose by over 90%. The leadframe for the device which is on the bottom also provides similar shielding.

If a device is expected to pass through luggage X-ray machines numerous times, it is advised to mount a 2-layer (minimum) PC board on the top, along with a ground plane underneath, which will effectively shield it from 50 to 100 passes through the machine. Because these machines vary in X-ray dose delivered, it is difficult to produce an accurate maximum pass recommendation.

Noise Performance and Reduction

The output noise voltage in a 0.1Hz to 10Hz bandwidth is typically $4.5\mu\text{V}_{\text{P-P}}$. The noise measurement is made with a bandpass filter made of a 1-pole high-pass filter with a corner frequency at 0.1Hz and a 2-pole low-pass filter with a corner frequency at 12.6Hz to create a filter with a 9.9Hz bandwidth. Noise in the 10kHz to 1MHz bandwidth is approximately $40\mu\text{V}_{\text{P-P}}$ with no capacitance on the output. This noise measurement is made with a 2 decade bandpass filter made of a 1-pole high-pass filter with a corner frequency at 1/10 of the center frequency and 1-pole low-pass filter with a corner frequency at 10 times the center frequency. Load capacitance up to 100pF can be added but will result in only marginal improvements in output noise and transient response. The output stage of the ISL21007 is not designed to drive heavily capacitive loads, so for load capacitances above $0.001\mu\text{F}$, the noise reduction network shown in [Figure 55 on page 17](#) is recommended. This network reduces noise significantly over the full bandwidth. Noise is reduced to less than $20\mu\text{V}_{\text{P-P}}$ from 1Hz to 1MHz using this network with a $0.01\mu\text{F}$ capacitor and a $2\text{k}\Omega$ resistor in series with a $10\mu\text{F}$ capacitor. Also, transient response is improved with higher value output capacitor. The $0.01\mu\text{F}$ value can be increased for better load transient response with little sacrifice in output stability.

Turn-On Time

The ISL21007 devices have low supply current and thus the time to bias up internal circuitry to final values will be longer than with higher power references. Normal turn-on time is typically $120\mu\text{s}$. This is shown in [Figure 10](#). Circuit design must take this into account when looking at power-up delays or sequencing.

Typical Application Circuits

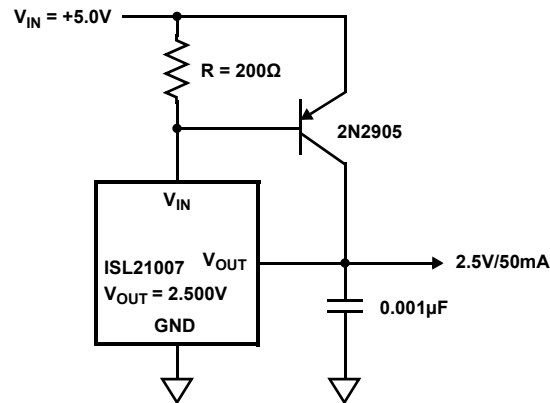

FIGURE 56. PRECISION 2.500V 50mA REFERENCE

Temperature Coefficient

The limits stated for temperature coefficient (tempco) are governed by the method of measurement. The overwhelming standard for specifying the temperature drift of a reference is to measure the reference voltage at two temperatures, take the total variation, $(V_{\text{HIGH}} - V_{\text{LOW}})$, and divide by the temperature extremes of measurement $(T_{\text{HIGH}} - T_{\text{LOW}})$. The result is divided by the nominal reference voltage (at $T = +25^\circ\text{C}$) and multiplied by 10^6 to yield $\text{ppm}/^\circ\text{C}$. This is the "Box" method for specifying temperature coefficient.

Output Voltage Adjustment

The output voltage can be adjusted up or down by 2.5% by placing a potentiometer from V_{OUT} to ground, and connecting the wiper to the TRIM pin. The TRIM input is high impedance, so no series resistance is needed. The resistor in the potentiometer should be a low tempco ($<50\text{ppm}/^\circ\text{C}$) and the resulting voltage divider should have very low tempco $<5\text{ppm}/^\circ\text{C}$. A digital potentiometer such as the ISL95810 provides a low tempco resistance and excellent resistor and tempco matching for trim applications. See [Figure 59](#) and [TB473](#) for further information.

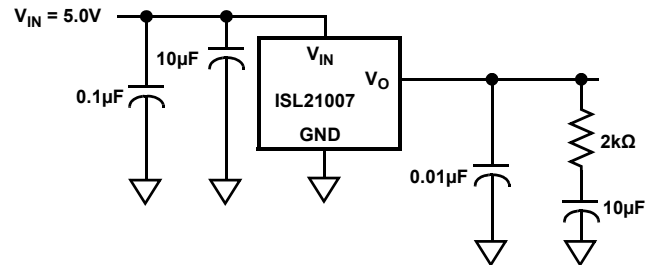

FIGURE 55. HANDLING HIGH LOAD CAPACITANCE

Typical Application Circuits (Continued)

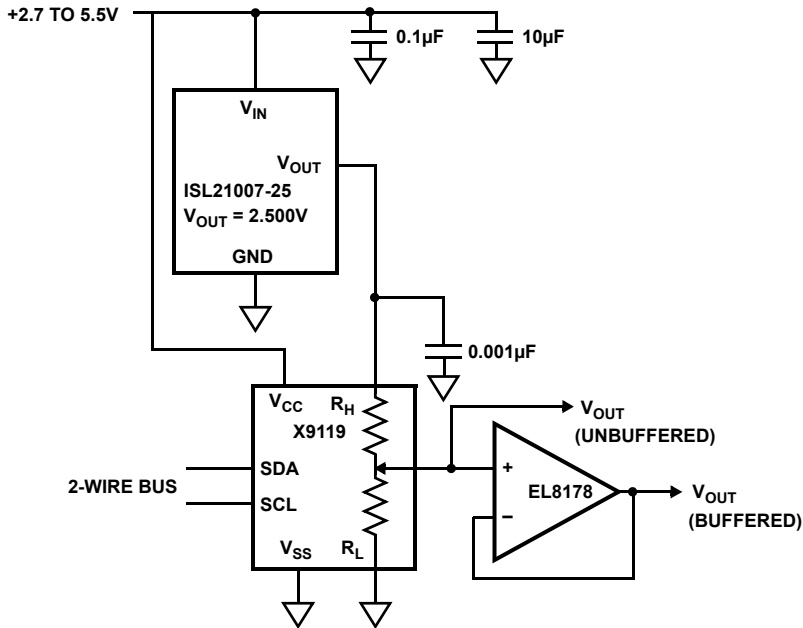

FIGURE 57. 2.500V FULL SCALE LOW-DRIFT, LOW NOISE, 10-BIT ADJUSTABLE VOLTAGE SOURCE

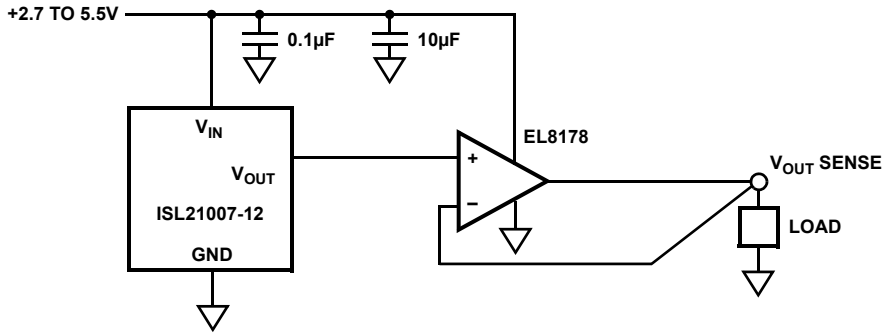

FIGURE 58. KELVIN SENSED LOAD

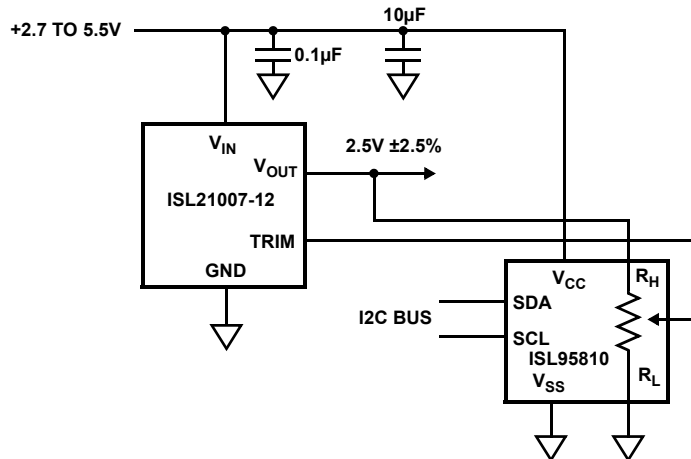

FIGURE 59. OUTPUT ADJUSTMENT USING THE TRIM PIN

Revision History The revision history provided is for informational purposes only and is believed to be accurate, but not warranted. Please visit our website to make sure that you have the latest revision.

DATE	REVISION	CHANGE
Jun 9, 2017	FN6326.12	Applied new header/footer. Updated Table 1 on page 1. Updated Related Literature section. Updated Ordering information table. Updated Note 2. Updated About Intersil section.
Sept 2, 2015	FN6326.11	Added Rev History beginning with Revision 11. Added About Intersil verbiage. Removed Initial Accuracy from Features on page 1. Updated Available Options Table on page 1. Updated Ordering Information on page 2. Moved Pin Configuration from page 1 to page 3.

About Intersil

Intersil Corporation is a leading provider of innovative power management and precision analog solutions. The company's products address some of the largest markets within the industrial and infrastructure, mobile computing and high-end consumer markets.

For the most updated datasheet, application notes, related documentation and related parts, please see the respective product information page found at www.intersil.com.

For a listing of definitions and abbreviations of common terms used in our documents, visit www.intersil.com/glossary.

You can report errors or suggestions for improving this datasheet by visiting www.intersil.com/ask.

Reliability reports are also available from our website at www.intersil.com/support.

© Copyright Intersil Americas LLC 2007-2017. All Rights Reserved.
All trademarks and registered trademarks are the property of their respective owners.

For additional products, see www.intersil.com/en/products.html

Intersil products are manufactured, assembled and tested utilizing ISO9001 quality systems as noted in the quality certifications found at www.intersil.com/en/support/qualandreliability.html

Intersil products are sold by description only. Intersil may modify the circuit design and/or specifications of products at any time without notice, provided that such modification does not, in Intersil's sole judgment, affect the form, fit or function of the product. Accordingly, the reader is cautioned to verify that datasheets are current before placing orders. Information furnished by Intersil is believed to be accurate and reliable. However, no responsibility is assumed by Intersil or its subsidiaries for its use; nor for any infringements of patents or other rights of third parties which may result from its use. No license is granted by implication or otherwise under any patent or patent rights of Intersil or its subsidiaries.

For information regarding Intersil Corporation and its products, see www.intersil.com

Package Outline Drawing

For the most recent package outline drawing, see [M8.15](#).

M8.15

8 LEAD NARROW BODY SMALL OUTLINE PLASTIC PACKAGE

Rev 4, 1/12

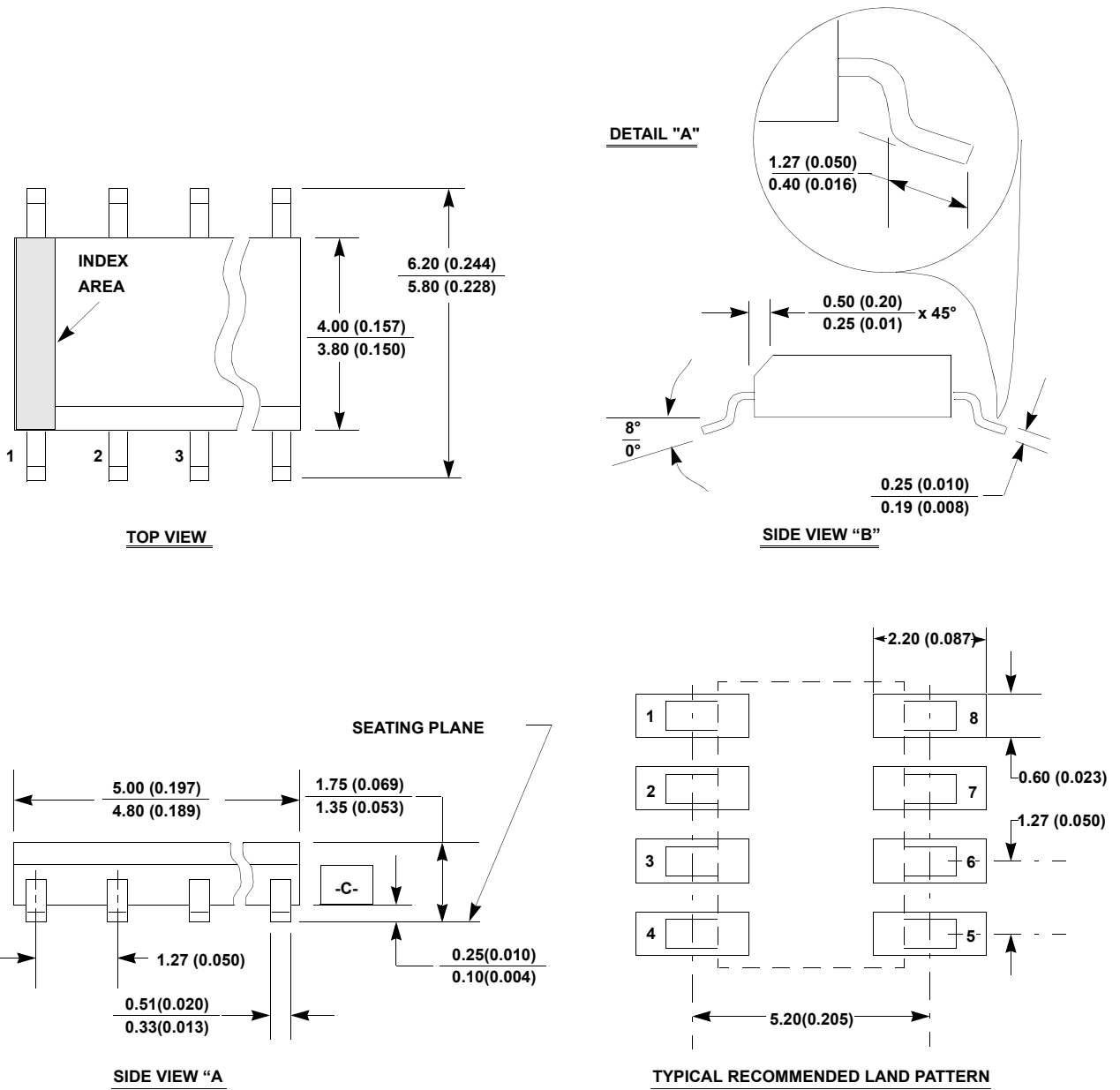

NOTES:

1. Dimensioning and tolerancing per ANSI Y14.5M-1994.
2. Package length does not include mold flash, protrusions or gate burrs. Mold flash, protrusion and gate burrs shall not exceed 0.15mm (0.006 inch) per side.
3. Package width does not include interlead flash or protrusions. Interlead flash and protrusions shall not exceed 0.25mm (0.010 inch) per side.
4. The chamfer on the body is optional. If it is not present, a visual index feature must be located within the crosshatched area.
5. Terminal numbers are shown for reference only.
6. The lead width as measured 0.36mm (0.014 inch) or greater above the seating plane, shall not exceed a maximum value of 0.61mm (0.024 inch).