

Overview

The low ESR, surge-robust T495 Series is designed for demanding applications that require high surge current and high ripple current capability. This series builds upon the proven capabilities of our industrial grade tantalum chip capacitors to offer several advantages such as low ESR, high ripple current capability, excellent capacitance stability, and improved resistance to high in-rush currents.

These benefits are achieved through a combination of proprietary design, materials, and process parameters as well as high-stress, low impedance electrical conditioning performed prior to screening. This series is classified as MSL (Moisture Sensitivity Level) 1 under J STD 020: unlimited floor life time at $\leq 30^{\circ}\text{C}/85\% \text{ RH}$.

Benefits

- Meets or exceeds EIA Standard 535BAAC
- Taped and reeled per EIA 481
- High surge current capability
- Optional gold-plated terminations
- High ripple current capability
- 100% surge current test on C, D, E, U, V, X sizes
- 100% steady-state accelerated aging
- Capacitance values of 0.1 μF to 1,000 μF
- Tolerances of $\pm 10\%$ and $\pm 20\%$
- Voltage rating of 2.5 – 50 VDC
- Extended range values
- RoHS Compliant and lead-free terminations
- Operating temperature range of -55°C to $+125^{\circ}\text{C}$

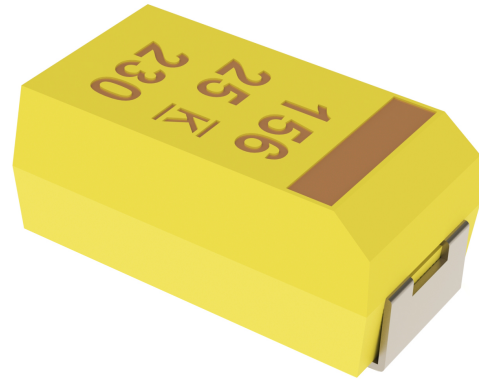

Applications

Typical applications include decoupling and filtering in automotive end applications, such as DC/DC converters, portable electronics, telecommunications, and control units requiring high ripple current capability.

Environmental Compliance

RoHS Compliant (6/6) according to Directive 2002/95/EC when ordered with 100% Sn solder, Gold plated or Non-magnetic 100% Sn solder.

K-SIM

For a detailed analysis of specific part numbers, please visit ksim.kemet.com to access KEMET's K-SIM software. KEMET K-SIM is designed to simulate behavior of components with respect to frequency, ambient temperature, and DC bias levels.

Ordering Information

T	495	X	107	M	010	A	T	E045	
Capacitor Class	Series	Case Size	Capacitance Code (pF)	Capacitance Tolerance	Rated Voltage (VDC)	Failure Rate/Design	Termination Finish	ESR	Packaging (C-Spec)
T = Tantalum	Surge Robust Low ESR	A, B, C, D, E, M, T, U, V, W, X	First two digits represent significant figures. Third digit specifies number of zeros.	K = ±10% M = ±20%	2R5 = 2.5 004 = 4 006 = 6.3 010 = 10 016 = 16 020 = 20 025 = 25 035 = 35 050 = 50	A = N/A	T = 100% Matte Tin (Sn) plated H = Standard solder coated (SnPb 5% Pb minimum) G = Gold plated (A, B, C, D, X only) N = Non-magnetic 100% Tin (Sn) M = Non-magnetic (SnPb)	Last three digits specify ESR in mΩ. (45 = 45 mΩ)	Blank = 7" Reel 7280 = 13" Reel

Performance Characteristics

Item	Performance Characteristics
Operating Temperature	-55°C to 125°C
Rated Capacitance Range	0.47 – 1,000 µF at 120 Hz/25°C
Capacitance Tolerance	K Tolerance (10%), M Tolerance (20%)
Rated Voltage Range	2.5 – 50 V
DF (120 Hz)	Refer to Part Number Electrical Specification Table
ESR (100 kHz)	Refer to Part Number Electrical Specification Table
Leakage Current	≤ 0.01 CV (µA) at rated voltage after 5 minutes

Qualification

Test	Condition	Characteristics				
Endurance	85°C at rated voltage, 2,000 hours. 125°C at 2/3 rated voltage, 2,000 hours.	Δ C/C	Within ±10% of initial value			
		DF	Within initial limits			
		DCL	Within 1.25 x initial limit			
		ESR	Within initial limits			
Storage Life	125°C at 0 volts, 2,000 hours.	Δ C/C	Within ±10% of initial value			
		DF	Within initial limits			
		DCL	Within 1.25 x initial limit			
		ESR	Within initial limits			
Thermal Shock	MIL-STD-202, Method 107, Condition B, mounted, -55°C to 125°C, 1,000 cycles.	Δ C/C	Within ±5% of initial value			
		DF	Within initial limits			
		DCL	Within 1.25 x initial limit			
		ESR	Within initial limits			
Temperature Stability	Extreme temperature exposure at a succession of continuous steps at +25°C, -55°C, +25°C, +85°C, +125°C, +25°C.	Δ C/C	+25°C	-55°C	+85°C	+125°C
		DF	IL*	±10%	±10%	±20%
		DCL	IL	IL	1.5 x IL	1.5 x IL
Surge Voltage	85°C, 1.32 x rated voltage 1,000 cycles (125°C, 1.2 x rated voltage).	Δ C/C	Within ±5% of initial value			
		DF	Within initial limits			
		DCL	Within initial limits			
		ESR	Within initial limits			
Mechanical Shock/ Vibration	MIL-STD-202, Method 213, Condition I, 100 G peak MIL-STD-202, Method 204, Condition D, 10 Hz to 2,000 Hz, 20 G peak	Δ C/C	Within ±10% of initial value			
		DF	Within initial limits			
		DCL	Within initial limits			

*IL = Initial limit

Electrical Characteristics

ESR vs. Frequency



Capacitance vs. Frequency

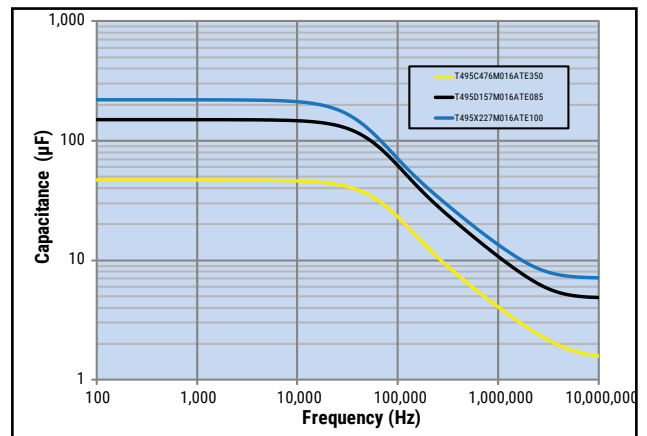

Dimensions – Millimeters (Inches)

Metric will govern

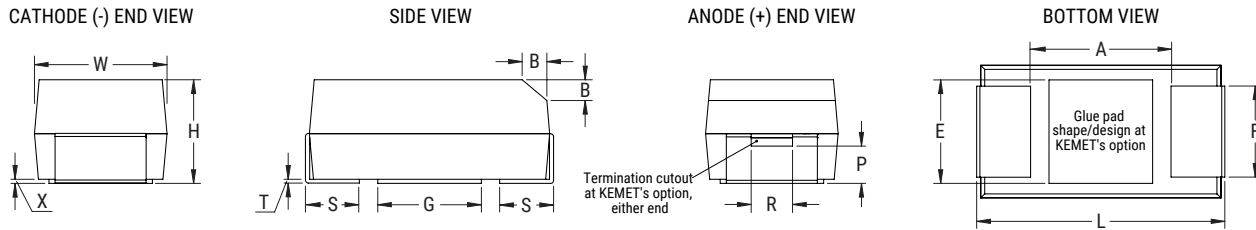

Case Size		Component													Total Weight
KEMET	EIA	L	W	H	F ±0.1 ±(0.004)	S	B ±0.15 (Ref) ±0.006	X (Ref)	P (Ref)	R (Ref)	T (Ref)	A (Min)	G (Ref)	E (Ref)	(mg)
A	3216-18	3.2±0.2 (0.126±0.008)	1.6±0.2 (0.063±0.008)	1.6±0.2 (0.063±0.008)	1.2 (0.047)	0.80 (0.032) +0.2 (0.008) /-0.3(0.011)	0.4 (0.016)	0.10±0.10 (0.004±0.004)	0.4 (0.016)	0.4 (0.016)	0.13 (0.005)	1.2 (0.047)	1.1 (0.043)	1.3 (0.051)	58.60
B	3528-21	3.5±0.2 (0.138±0.008)	2.8±0.2 (0.110±0.008)	1.9±0.2 (0.075±0.008)	2.2 (0.087)	0.80 (0.032) +0.1 (0.004) /-0.3(0.011)	0.4 (0.016)	0.10±0.10 (0.004±0.004)	0.5 (0.020)	1.0 (0.039)	0.13 (0.005)	1.9 (0.075)	1.8 (0.071)	2.2 (0.087)	107.45
M	3528-15	3.5±0.2 (0.138±0.008)	2.8±0.2 (0.110±0.008)	1.5 (0.059)	2.2 (0.087)	0.8 (0.031) ±0.3 (0.012)	N/A	0.05 (0.002)	N/A	N/A	0.13 (0.005)	1.9 (0.075)	1.8 (0.071)	2.2 (0.087)	97.99
C	6032-28	6.0±0.3 (0.236±0.012)	3.2±0.3 (0.126±0.012)	2.5±0.3 (0.098±0.012)	2.2 (0.087)	1.3 (0.051) ±0.3 (0.012)	0.5 (0.020)	0.10±0.10 (0.004±0.004)	0.9 (0.035)	1.0 (0.039)	0.13 (0.005)	2.9 (0.114)	2.8 (0.110)	2.4 (0.094)	224.48
U	6032-15	6.0±0.3 (0.236±0.012)	3.2±0.2 (0.110±0.008)	1.5 (0.059)	2.2 (0.087)	1.3 (0.051) ±0.3 (0.012)	N/A	0.05 (0.002)	N/A	N/A	0.13 (0.005)	2.9 (0.114)	2.8 (0.110)	2.4 (0.094)	70.00
D	7343-31	7.3±0.3 (0.287±0.012)	4.3±0.3 (0.169±0.012)	2.8±0.3 (0.110±0.012)	2.4 (0.094)	1.3 (0.051) ±0.3 (0.012)	0.5 (0.020)	0.10±0.10 (0.004±0.004)	0.9 (0.035)	1.0 (0.039)	0.13 (0.005)	3.6 (0.142)	3.5 (0.138)	3.5 (0.138)	446.84
W	7343-15	7.3±0.3 (0.287±0.012)	4.3±0.3 (0.169±0.012)	1.5 (0.059)	2.4 (0.094)	1.3 (0.051) ±0.3 (0.012)	N/A	0.05 (0.002)	N/A	N/A	0.13 (0.005)	3.6 (0.142)	3.5 (0.138)	3.5 (0.138)	248.27
X	7343-43	7.3±0.3 (0.287±0.012)	4.3±0.3 (0.169±0.012)	4.0±0.3 (0.157±0.012)	2.4 (0.094)	1.3 (0.051) ±0.3 (0.012)	0.5 (0.020)	0.10±0.10 (0.004±0.004)	1.7 (0.067)	1.0 (0.039)	0.13 (0.005)	3.6 (0.142)	3.5 (0.138)	3.5 (0.138)	652.04
E	7360-38	7.3±0.3 (0.287±0.012)	6.0±0.3 (0.236±0.012)	3.6±0.2 (0.142±0.008)	4.1 (0.161)	1.3 (0.051) ±0.3 (0.012)	0.5 (0.020)	0.10±0.10 (0.004±0.004)	N/A	N/A	0.13 (0.005)	3.6 (0.142)	3.5 (0.138)	3.5 (0.138)	803.76
T	3528-12	3.5±0.2 (0.138±0.008)	2.8±0.2 (0.110±0.008)	1.2 (0.047)	2.2 (0.087)	0.80 (0.032) +0.1 (0.004) /-0.3(0.011)	N/A	0.05 (0.002)	N/A	N/A	0.13 (0.005)	1.9 (0.075)	1.8 (0.071)	2.2 (0.087)	63.89
V	7343-20	7.3±0.3 (0.287±0.012)	4.3±0.3 (0.169±0.012)	2.0 (0.079)	2.4 (0.094)	1.3 (0.051) ±0.3 (0.012)	N/A	0.05 (0.002)	N/A	N/A	0.13 (0.005)	3.6 (0.142)	3.5 (0.138)	3.5 (0.138)	286.40

Notes: (Ref) – Dimensions provided for reference only. For low profile cases, no dimensions are provided for B, P or R because these cases do not have a bevel or a notch.

These weights are provided as reference. If exact weights are needed, please contact your KEMET Sales Representative

Table 1 – Ratings & Part Number Reference

Rated Voltage	Rated Cap	Case Code/ Case Size	KEMET Part Number	DC Leakage	DF	ESR	Maximum Allowable Ripple Current			Maximum Operating Temp	MSL
							mA at +25°C 100 kHz	mA at +85°C 100 kHz	mA at +125°C 100 kHz		
VDC at 85°C	µF	KEMET/EIA	(See below for part options)	µA +20°C Max/5 Min	% at +20°C 120 Hz Max	mΩ at 20°C 100 kHz Max	mA at +25°C 100 kHz	mA at +85°C 100 kHz	mA at +125°C 100 kHz	°C	Reflow Temp ≤ 260°C
2.5	100	T/3528-12	T495T107(M)2R5A(2)E3K0	2.5	24.0	3000	153	138	61	125	1
2.5	220	D/7343-31	T495D227(1)2R5A(2)E045	5.5	8.0	45	1826	1643	730	125	1
2.5	470	D/7343-31	T495D477(1)2R5A(2)E035	11.8	8.0	35	2070	1863	828	125	1
2.5	1000	X/7343-43	T495X108(1)2R5A(2)E030	25.0	15.0	30	2345	2111	938	125	1
2.5	1000	X/7343-43	T495X108(1)2R5A(2)E040	25.0	15.0	40	2031	1828	812	125	1
4	6.8	A/3216-18	T495A685(1)004A(2)E2K0	0.5	6.0	2000	194	175	78	125	1
4	22	C/6032-28	T495C226(1)004A(2)E2K4	0.9	6.0	2400	214	193	86	125	1
4	22	C/6032-28	T495C226(1)004A(2)E380	0.9	6.0	380	538	484	215	125	1
4	33	T/3528-12	T495T336(1)004A(2)E1K2	1.3	8.0	1200	242	218	97	125	1
4	47	T/3528-12	T495T476(1)004A(2)E1K0	1.9	10.0	1000	265	239	106	125	1
4	68	T/3528-12	T495T686(1)004A(2)E1K5	2.7	20.0	1500	216	194	86	125	1
4	68	V/7343-20	T495V686(1)004A(2)E150	2.7	6.0	150	913	822	365	125	1
4	100	B/3528-21	T495B107(1)004A(2)E500	4.0	8.0	500	412	371	165	125	1
4	100	D/7343-31	T495D107(1)004A(2)E800	4.0	6.0	800	433	390	173	125	1
4	150	B/3528-21	T495B157(M)004A(2)E900	6.0	12.0	900	307	276	123	125	1
4	150	C/6032-28	T495C157(1)004A(2)E070	6.0	12.0	70	1254	1129	502	125	1
4	150	C/6032-28	T495C157(1)004A(2)E250	6.0	8.0	250	663	597	265	125	1
4	150	U/6032-15	T495U157(1)004A(2)E200	6.0	8.0	200	671	604	268	125	1
4	220	D/7343-31	T495D227(1)004A(2)E040	8.8	8.0	40	1936	1742	774	125	1
4	220	D/7343-31	T495D227(1)004A(2)E050	8.8	8.0	50	1732	1559	693	125	1
4	220	D/7343-31	T495D227(1)004A(2)E100	8.8	8.0	100	1225	1103	490	125	1
4	330	C/6032-28	T495C337(1)004A(2)E300	13.2	10.0	300	606	545	242	125	1
4	330	C/6032-28	T495C337(1)004A(2)E700	13.2	12.0	700	396	356	158	125	1
4	330	D/7343-31	T495D337(1)004A(2)E030	13.2	8.0	30	2236	2012	894	125	1
4	330	D/7343-31	T495D337(1)004A(2)E045	13.2	8.0	45	1826	1643	730	125	1
4	330	D/7343-31	T495D337(1)004A(2)E100	13.2	8.0	100	1225	1103	490	125	1
4	470	D/7343-31	T495D477(1)004A(2)E045	18.8	12.0	45	1826	1643	730	125	1
4	470	D/7343-31	T495D477(1)004A(2)E100	18.8	12.0	100	1225	1103	490	125	1
4	470	X/7343-43	T495X477(1)004A(2)E030	18.8	8.0	30	2345	2111	938	125	1
4	470	X/7343-43	T495X477(1)004A(2)E045	18.8	8.0	45	1915	1724	766	125	1
4	470	X/7343-43	T495X477(1)004A(2)E060	18.8	10.0	60	1658	1492	663	125	1
4	470	X/7343-43	T495X477(1)004A(2)E100	18.8	8.0	100	1285	1157	514	125	1
4	680	X/7343-43	T495X687(1)004A(2)E040	27.2	10.0	40	2031	1828	812	125	1
4	680	X/7343-43	T495X687(1)004A(2)E060	27.2	10.0	60	1658	1492	663	125	1
4	680	X/7343-43	T495X687(1)004A(2)E100	27.2	10.0	100	1285	1157	514	125	1
4	1000	X/7343-43	T495X108(1)004A(2)E030	40.0	10.0	30	2345	2111	938	125	1
4	1000	X/7343-43	T495X108(1)004A(2)E040	40.0	10.0	40	2031	1828	812	125	1
4	1000	X/7343-43	T495X108(1)004A(2)E060	40.0	10.0	60	1658	1492	663	125	1
4	1000	X/7343-43	T495X108(1)004A(2)E070	40.0	10.0	70	1535	1382	614	125	1
4	1000	X/7343-43	T495X108(1)004A(2)E090	40.0	10.0	90	1354	1219	542	125	1
4	1000	X/7343-43	T495X108(1)004A(2)E100	40.0	10.0	100	1285	1157	514	125	1
4	1000	E/7360-38	T495E108(1)004A(2)E035	40.0	15.0	35	2390	2151	956	125	1
4	1000	E/7360-38	T495E108(1)004A(2)E050	40.0	15.0	50	2000	1800	800	125	1
6.3	2.2	A/3216-18	T495A225(1)006ATE5K0	0.5	6.0	5000	122	110	49	125	1
6.3	3.3	A/3216-18	T495A335(1)006ATE3K0	0.5	6.0	3000	158	142	63	125	1
VDC at 85°C	µF	KEMET/EIA	(See below for part options)	µA +20°C Max/5 Min	% at +20°C 120 Hz Max	mΩ at 20°C 100 kHz Max	mA at +25°C 100 kHz	mA at +85°C 100 kHz	mA at +125°C 100 kHz	°C	Reflow Temp ≤ 260°C
Rated Voltage	Rated Cap	Case Code/ Case Size	KEMET Part Number	DC Leakage	DF	ESR	Maximum Allowable Ripple Current			Maximum Operating Temp	MSL

(1) To complete KEMET part number, insert M for ±20% or K for ±10%. Designates capacitance tolerance.

(2) To complete KEMET part number, insert T = 100% Matte Tin (Sn) Plated, G = Gold Plated, H = Standard Solder coated (SnPb 5% Pb minimum), N = Non-Magnetic 100% Tin (Sn) or M = Non-Magnetic (SnPb). Designates termination finish.

Refer to Ordering Information for additional detail.

Higher voltage ratings and tighter tolerance product including ESR may be substituted within the same size at KEMET's option. Voltage substitution will be marked with the higher voltage rating. Substitutions can include better than series.

Table 1 – Ratings & Part Number Reference cont'd

Rated Voltage	Rated Cap	Case Code/ Case Size	KEMET Part Number	DC Leakage	DF	ESR	Maximum Allowable Ripple Current			Maximum Operating Temp	MSL
							mA at +25°C 100 kHz	mA at +85°C 100 kHz	mA at +125°C 100 kHz		
VDC at 85°C	µF	KEMET/EIA	(See below for part options)	µA +20°C Max/5 Min	% at +20°C 120 Hz Max	mΩ at 20°C 100 kHz Max	mA at +25°C 100 kHz	mA at +85°C 100 kHz	mA at +125°C 100 kHz	°C	Reflow Temp ≤ 260°C
6.3	6.8	A/3216-18	T495A685(1)006ATE1K8	0.5	6.0	1800	204	184	82	125	1
6.3	6.8	A/3216-18	T495A685(1)006ATE2K0	0.5	6.0	2000	194	175	78	125	1
6.3	6.8	A/3216-18	T495A685(1)006A(2)E4K5	0.5	6.0	4500	129	116	52	125	1
6.3	6.8	C/6032-28	T495C685(1)006A(2)E480	0.5	6.0	480	479	431	192	125	1
6.3	10	A/3216-18	T495A106(1)006A(2)E800	0.6	6.0	800	306	275	122	125	1
6.3	10	A/3216-18	T495A106(1)006A(2)E1K0	0.6	6.0	1000	274	247	110	125	1
6.3	10	A/3216-18	T495A106(1)006A(2)E1K5	0.6	6.0	1500	224	202	90	125	1
6.3	10	A/3216-18	T495A106(1)006A(2)E2K0	0.6	6.0	2000	194	175	78	125	1
6.3	10	B/3528-21	T495B106(1)006A(2)E1K0	0.6	6.0	1000	292	263	117	125	1
6.3	10	T/3528-12	T495T106(1)006A(2)E1K2	0.6	6.0	1200	242	218	97	125	1
6.3	15	A/3216-18	T495A156(1)006A(2)E2K0	0.9	6.0	2000	194	175	78	125	1
6.3	15	T/3528-12	T495T156(1)006A(2)E1K0	0.9	6.0	1000	265	239	106	125	1
6.3	22	A/3216-18	T495A226(1)006A(2)E500	1.4	6.0	500	387	348	155	125	1
6.3	22	A/3216-18	T495A226(1)006A(2)E900	1.4	8.0	900	289	260	116	125	1
6.3	22	A/3216-18	T495A226(1)006A(2)E1K5	1.4	8.0	1500	224	202	90	125	1
6.3	22	B/3528-21	T495B226(1)006A(2)E500	1.4	6.0	500	412	371	165	125	1
6.3	22	C/6032-28	T495C226(1)006A(2)E380	1.4	6.0	380	538	484	215	125	1
6.3	33	A/3216-18	T495A336(1)006A(2)E600	2.1	12.0	600	354	319	142	125	1
6.3	33	B/3528-21	T495B336(1)006A(2)E600	2.1	6.0	600	376	338	150	125	1
6.3	33	T/3528-12	T495T336(1)006A(2)E800	2.1	6.0	800	296	266	118	125	1
6.3	33	C/6032-28	T495C336(1)006A(2)E350	2.1	6.0	350	561	505	224	125	1
6.3	47	B/3528-21	T495B476(1)006A(2)E250	3.0	6.0	250	583	525	233	125	1
6.3	47	B/3528-21	T495B476(1)006A(2)E500	3.0	6.0	500	583	525	233	125	1
6.3	47	B/3528-21	T495B476(1)006A(2)E450	3.0	6.0	450	435	392	174	125	1
6.3	47	B/3528-21	T495B476(1)006A(2)E400	3.0	6.0	400	461	415	184	125	1
6.3	47	C/6032-28	T495C476(1)006A(2)E250	3.0	6.0	250	663	597	265	125	1
6.3	47	C/6032-28	T495C476(1)006A(2)E300	3.0	6.0	300	606	545	242	125	1
6.3	47	C/6032-28	T495C476(1)006A(2)E330	3.0	6.0	330	577	519	231	125	1
6.3	47	V/7343-20	T495V476(1)006A(2)E150	3.0	6.0	150	913	822	365	125	1
6.3	68	B/3528-21	T495B686(1)006A(2)E500	4.3	8.0	500	412	371	165	125	1
6.3	68	C/6032-28	T495C686(1)006A(2)E400	4.3	6.0	400	524	472	210	125	1
6.3	68	U/6032-15	T495U686(1)006A(2)E400	4.3	6.0	400	474	427	190	125	1
6.3	68	D/7343-31	T495D686(1)006A(2)E175	4.3	4.0	175	926	833	370	125	1
6.3	68	D/7343-31	T495D686(1)006A(2)E180	4.3	4.0	180	913	822	365	125	1
6.3	100	B/3528-21	T495B107(1)006A(2)E400	6.3	15.0	400	461	415	184	125	1
6.3	100	B/3528-21	T495B107(M)006A(2)E700	6.3	15.0	700	348	313	139	125	1
6.3	100	M/3528-15	T495M107(1)006A(2)E500	6.3	20.0	500	490	441	196	125	1
6.3	100	M/3528-15	T495M107(1)006A(2)E1K0	6.3	20.0	1000	346	311	138	125	1
6.3	100	C/6032-28	T495C107(1)006A(2)E075	6.3	8.0	75	1211	1090	484	125	1
6.3	100	C/6032-28	T495C107(1)006A(2)E150	6.3	8.0	150	856	770	342	125	1
6.3	100	D/7343-31	T495D107(1)006A(2)E050	6.3	6.0	50	1732	1559	693	125	1
6.3	100	D/7343-31	T495D107(1)006A(2)E130	6.3	6.0	130	1074	967	430	125	1
6.3	100	D/7343-31	T495D107(1)006A(2)E150	6.3	8.0	150	1000	900	400	125	1
6.3	100	D/7343-31	T495D107(1)006A(2)E800	6.3	6.0	800	433	390	173	125	1
6.3	100	V/7343-20	T495V107(1)006A(2)E090	6.3	8.0	90	1179	1061	472	125	1
VDC at 85°C	µF	KEMET/EIA	(See below for part options)	µA +20°C Max/5 Min	% at +20°C 120 Hz Max	mΩ at 20°C 100 kHz Max	mA at +25°C 100 kHz	mA at +85°C 100 kHz	mA at +125°C 100 kHz	°C	Reflow Temp ≤ 260°C
Rated Voltage	Rated Cap	Case Code/ Case Size	KEMET Part Number	DC Leakage	DF	ESR	Maximum Allowable Ripple Current			Maximum Operating Temp	MSL

(1) To complete KEMET part number, insert M for ±20% or K for ±10%. Designates capacitance tolerance.

(2) To complete KEMET part number, insert T = 100% Matte Tin (Sn) Plated, G = Gold Plated, H = Standard Solder coated (SnPb 5% Pb minimum), N = Non-Magnetic 100% Tin (Sn) or M = Non-Magnetic (SnPb). Designates termination finish.

Refer to Ordering Information for additional detail.

Higher voltage ratings and tighter tolerance product including ESR may be substituted within the same size at KEMET's option. Voltage substitution will be marked with the higher voltage rating. Substitutions can include better than series.

Table 1 – Ratings & Part Number Reference cont'd

Rated Voltage	Rated Cap	Case Code/ Case Size	KEMET Part Number	DC Leakage	DF	ESR	Maximum Allowable Ripple Current			Maximum Operating Temp	MSL
							mA at +25°C 100 kHz	mA at +85°C 100 kHz	mA at +125°C 100 kHz		
VDC at 85°C	µF	KEMET/EIA	(See below for part options)	µA +20°C Max/5 Min	% at +20°C 120 Hz Max	mΩ at 20°C 100 kHz Max	mA at +25°C 100 kHz	mA at +85°C 100 kHz	mA at +125°C 100 kHz	°C	Reflow Temp ≤ 260°C
6.3	100	V/7343-20	T495V107(1)006A(2)E150	6.3	8.0	150	913	822	365	125	1
6.3	150	C/6032-28	T495C157(1)006A(2)E050	9.5	8.0	50	1483	1335	593	125	1
6.3	150	C/6032-28	T495C157(M)006A(2)E200	9.5	8.0	200	742	668	297	125	1
6.3	150	U/6032-15	T495U157(1)006A(2)E200	9.5	8.0	200	671	604	268	125	1
6.3	150	V/7343-20	T495V157(1)006A(2)E040	9.5	8.0	40	1768	1591	707	125	1
6.3	150	V/7343-20	T495V157(1)006A(2)E070	9.5	8.0	70	1336	1202	534	125	1
6.3	150	V/7343-20	T495V157(1)006A(2)E150	9.5	8.0	150	913	822	365	125	1
6.3	150	D/7343-31	T495D157(1)006A(2)E050	9.5	6.0	50	1732	1559	693	125	1
6.3	150	D/7343-31	T495D157(1)006A(2)E065	9.5	6.0	65	1519	1367	608	125	1
6.3	150	D/7343-31	T495D157(1)006A(2)E080	9.5	6.0	80	1369	1232	548	125	1
6.3	150	D/7343-31	T495D157(1)006A(2)E100	9.5	6.0	100	1225	1103	490	125	1
6.3	150	D/7343-31	T495D157(1)006A(2)E125	9.5	6.0	125	1095	986	438	125	1
6.3	150	X/7343-43	T495X157(1)006A(2)E100	9.5	6.0	100	1285	1157	514	125	1
6.3	220	C/6032-28	T495C227(1)006A(2)E225	13.9	10.0	225	699	629	280	125	1
6.3	220	C/6032-28	T495C227(1)006A(2)E200	13.9	10.0	200	742	668	297	125	1
6.3	220	C/6032-28	T495C227(1)006A(2)E100	13.9	10.0	100	1049	944	420	125	1
6.3	220	D/7343-31	T495D227(1)006A(2)E045	13.9	8.0	45	1826	1643	730	125	1
6.3	220	D/7343-31	T495D227(1)006A(2)E050	13.9	8.0	50	1732	1559	693	125	1
6.3	220	D/7343-31	T495D227(1)006A(2)E100	13.9	8.0	100	1225	1103	490	125	1
6.3	220	W/7343-15	T495W227(1)006A(2)E250	13.9	8.0	250	849	764	340	125	1
6.3	220	X/7343-43	T495X227(1)006A(2)E070	13.9	8.0	70	1535	1382	614	125	1
6.3	220	X/7343-43	T495X227(1)006A(2)E080	13.9	8.0	80	1436	1292	574	125	1
6.3	220	X/7343-43	T495X227(1)006A(2)E100	13.9	8.0	100	1285	1157	514	125	1
6.3	220	V/7343-20	T495V227(1)006ATE150	13.9	8.0	150	913	822	365	125	1
6.3	330	C/6032-28	T495C337(1)006A(2)E200	20.8	18.0	200	742	668	297	125	1
6.3	330	D/7343-31	T495D337(1)006A(2)E040	20.8	8.0	40	1936	1742	774	125	1
6.3	330	D/7343-31	T495D337(1)006A(2)E045	20.8	8.0	45	1826	1643	730	125	1
6.3	330	D/7343-31	T495D337(1)006A(2)E050	20.8	8.0	50	1732	1559	693	125	1
6.3	330	D/7343-31	T495D337(1)006A(2)E070	20.8	8.0	70	1464	1318	586	125	1
6.3	330	D/7343-31	T495D337(1)006A(2)E100	20.8	8.0	100	1225	1103	490	125	1
6.3	330	V/7343-20	T495V337(1)006A(2)E150	20.8	8.0	150	913	822	365	125	1
6.3	330	X/7343-43	T495X337(1)006A(2)E045	20.8	8.0	45	1915	1724	766	125	1
6.3	330	X/7343-43	T495X337(1)006A(2)E050	20.8	8.0	50	1817	1635	727	125	1
6.3	330	X/7343-43	T495X337(1)006A(2)E065	20.8	8.0	65	1593	1434	637	125	1
6.3	330	X/7343-43	T495X337(1)006A(2)E080	20.8	8.0	80	1436	1292	574	125	1
6.3	330	X/7343-43	T495X337(1)006A(2)E100	20.8	8.0	100	1285	1157	514	125	1
6.3	330	E/7360-38	T495E337(1)006A(2)E060	20.8	8.0	60	1826	1643	730	125	1
6.3	330	E/7360-38	T495E337(1)006A(2)E100	20.8	8.0	100	1414	1273	566	125	1
6.3	470	D/7343-31	T495D477(1)006A(2)E045	29.6	12.0	45	1826	1643	730	125	1
6.3	470	D/7343-31	T495D477(1)006A(2)E100	29.6	12.0	100	1225	1103	490	125	1
6.3	470	D/7343-31	T495D477(1)006A(2)E125	29.6	12.0	125	1095	986	438	125	1
6.3	470	D/7343-31	T495D477(1)006A(2)E150	29.6	12.0	150	1000	900	400	125	1
6.3	470	V/7343-20	T495V477(1)006A(2)E150	29.6	15.0	150	913	822	365	125	1
6.3	470	X/7343-43	T495X477(1)006A(2)E030	29.6	10.0	30	2345	2111	938	125	1
6.3	470	X/7343-43	T495X477(1)006A(2)E045	29.6	10.0	45	1915	1724	766	125	1
VDC at 85°C	µF	KEMET/EIA	(See below for part options)	µA +20°C Max/5 Min	% at +20°C 120 Hz Max	mΩ at 20°C 100 kHz Max	mA at +25°C 100 kHz	mA at +85°C 100 kHz	mA at +125°C 100 kHz	°C	Reflow Temp ≤ 260°C
Rated Voltage	Rated Cap	Case Code/ Case Size	KEMET Part Number	DC Leakage	DF	ESR	Maximum Allowable Ripple Current			Maximum Operating Temp	MSL

(1) To complete KEMET part number, insert M for ±20% or K for ±10%. Designates capacitance tolerance.

(2) To complete KEMET part number, insert T = 100% Matte Tin (Sn) Plated, G = Gold Plated, H = Standard Solder coated (SnPb 5% Pb minimum), N = Non-Magnetic 100% Tin (Sn) or M = Non-Magnetic (SnPb). Designates termination finish.

Refer to Ordering Information for additional detail.

Higher voltage ratings and tighter tolerance product including ESR may be substituted within the same size at KEMET's option. Voltage substitution will be marked with the higher voltage rating. Substitutions can include better than series.

Table 1 – Ratings & Part Number Reference cont'd

Rated Voltage	Rated Cap	Case Code/ Case Size	KEMET Part Number	DC Leakage	DF	ESR	Maximum Allowable Ripple Current			Maximum Operating Temp	MSL
							mA at +25°C 100 kHz	mA at +85°C 100 kHz	mA at +125°C 100 kHz		
VDC at 85°C	µF	KEMET/EIA	(See below for part options)	µA +20°C Max/5 Min	% at +20°C 120 Hz Max	mΩ at 20°C 100 kHz Max	mA at +25°C 100 kHz	mA at +85°C 100 kHz	mA at +125°C 100 kHz	°C	Reflow Temp ≤ 260°C
6.3	470	X/7343-43	T495X477(1)006A(2)E050	29.6	10.0	50	1817	1635	727	125	1
6.3	470	X/7343-43	T495X477(1)006A(2)E060	29.6	10.0	60	1658	1492	663	125	1
6.3	470	X/7343-43	T495X477(1)006A(2)E065	29.6	10.0	65	1593	1434	637	125	1
6.3	470	X/7343-43	T495X477(1)006A(2)E100	29.6	10.0	100	1285	1157	514	125	1
6.3	470	X/7343-43	T495X477(1)006A(2)E125	29.6	10.0	125	1149	1034	460	125	1
6.3	470	E/7360-38	T495E477(1)006A(2)E040	29.6	12.0	40	2236	2012	894	125	1
6.3	470	E/7360-38	T495E477(1)006A(2)E055	29.6	10.0	55	1907	1716	763	125	1
6.3	470	E/7360-38	T495E477(1)006A(2)E100	29.6	10.0	100	1414	1273	566	125	1
6.3	680	X/7343-43	T495X687(1)006A(2)E100	42.8	12.0	100	1285	1157	514	125	1
6.3	680	X/7343-43	T495X687(1)006A(2)E060	42.8	12.0	60	1658	1492	663	125	1
6.3	680	X/7343-43	T495X687(1)006A(2)E045	42.8	12.0	45	1915	1724	766	125	1
6.3	1000	X/7343-43	T495X108(1)006A(2)E100	63.0	20.0	100	1285	1157	514	125	1
6.3	1000	E/7360-38	T495E108(1)006A(2)E050	63.0	15.0	50	2000	1800	800	125	1
10	2.2	A/3216-18	T495A225(1)010A(2)E1K8	0.5	6.0	1800	204	184	82	125	1
10	2.2	A/3216-18	T495A225(1)010A(2)E7K0	0.5	6.0	7000	104	94	42	125	1
10	3.3	A/3216-18	T495A335(1)010A(2)E2K0	0.5	6.0	2000	194	175	78	125	1
10	4.7	A/3216-18	T495A475(1)010A(2)E1K2	0.5	6.0	1200	250	225	100	125	1
10	4.7	A/3216-18	T495A475(1)010A(2)E1K3	0.5	6.0	1300	240	216	96	125	1
10	4.7	A/3216-18	T495A475(1)010A(2)E1K4	0.5	6.0	1400	231	208	92	125	1
10	4.7	A/3216-18	T495A475(1)010A(2)E1K8	0.5	6.0	1800	204	184	82	125	1
10	4.7	A/3216-18	T495A475(1)010A(2)E2K0	0.5	6.0	2000	194	175	78	125	1
10	4.7	B/3528-21	T495B475(1)010A(2)E1K3	0.5	15.0	1300	256	230	102	125	1
10	4.7	B/3528-21	T495B475(1)010A(2)E1K5	0.5	6.0	1500	238	214	95	125	1
10	6.8	A/3216-18	T495A685(1)010A(2)E1K8	0.7	6.0	1800	204	184	82	125	1
10	6.8	B/3528-21	T495B685(1)010A(2)E900	0.7	6.0	900	307	276	123	125	1
10	6.8	B/3528-21	T495B685(1)010A(2)E1K1	0.7	6.0	1100	278	250	111	125	1
10	6.8	B/3528-21	T495B685(1)010A(2)E1K2	0.7	6.0	1200	266	239	106	125	1
10	10	A/3216-18	T495A106(1)010A(2)E1K8	1.0	6.0	1800	204	184	82	125	1
10	10	A/3216-18	T495A106(1)010A(2)E2K0	1.0	6.0	2000	194	175	78	125	1
10	10	A/3216-18	T495A106(1)010A(2)E2K5	1.0	6.0	2500	173	156	69	125	1
10	10	A/3216-18	T495A106(1)010A(2)E3K8	1.0	6.0	3800	140	126	56	125	1
10	10	B/3528-21	T495B106(1)010A(2)E600	1.0	6.0	600	376	338	150	125	1
10	10	B/3528-21	T495B106(1)010A(2)E750	1.0	6.0	750	337	303	135	125	1
10	10	B/3528-21	T495B106(1)010A(2)E1K2	1.0	6.0	1200	266	239	106	125	1
10	10	B/3528-21	T495B106(1)010A(2)E3K0	1.0	6.0	3000	168	151	67	125	1
10	10	C/6032-28	T495C106(1)010AT E400	1.0	6.0	400	524	472	210	125	1
10	10	T/3528-12	T495T106(1)010AT E1K5	1.0	6.0	1500	216	194	86	125	1
10	15	A/3216-18	T495A156(1)010AT E1K0	1.5	6.0	1000	274	247	110	125	1
10	15	A/3216-18	T495A156(1)010AT E1K8	1.5	6.0	1800	204	184	82	125	1
10	15	B/3528-21	T495B156(1)010AT E600	1.5	6.0	600	376	338	150	125	1
10	15	B/3528-21	T495B156(1)010AT E900	1.5	6.0	900	307	276	123	125	1
10	15	T/3528-12	T495T156(1)010AT E1K2	1.5	6.0	1200	242	218	97	125	1
10	15	B/3528-21	T495B156(1)010A(2)E500	1.5	6.0	500	412	371	165	125	1
10	15	C/6032-28	T495C156(1)010A(2)E375	1.5	6.0	375	542	488	217	125	1
10	15	C/6032-28	T495C156(1)010A(2)E400	1.5	6.0	400	524	472	210	125	1
VDC at 85°C	µF	KEMET/EIA	(See below for part options)	µA +20°C Max/5 Min	% at +20°C 120 Hz Max	mΩ at 20°C 100 kHz Max	mA at +25°C 100 kHz	mA at +85°C 100 kHz	mA at +125°C 100 kHz	°C	Reflow Temp ≤ 260°C
Rated Voltage	Rated Cap	Case Code/ Case Size	KEMET Part Number	DC Leakage	DF	ESR	Maximum Allowable Ripple Current			Maximum Operating Temp	MSL

(1) To complete KEMET part number, insert M for ±20% or K for ±10%. Designates capacitance tolerance.

(2) To complete KEMET part number, insert T = 100% Matte Tin (Sn) Plated, G = Gold Plated, H = Standard Solder coated (SnPb 5% Pb minimum), N = Non-Magnetic 100% Tin (Sn) or M = Non-Magnetic (SnPb). Designates termination finish.

Refer to Ordering Information for additional detail.

Higher voltage ratings and tighter tolerance product including ESR may be substituted within the same size at KEMET's option. Voltage substitution will be marked with the higher voltage rating. Substitutions can include better than series.

Table 1 – Ratings & Part Number Reference cont'd

Rated Voltage	Rated Cap	Case Code/ Case Size	KEMET Part Number	DC Leakage	DF	ESR	Maximum Allowable Ripple Current			Maximum Operating Temp	MSL
							mA at +25°C 100 kHz	mA at +85°C 100 kHz	mA at +125°C 100 kHz		
VDC at 85°C	µF	KEMET/EIA	(See below for part options)	µA +20°C Max/5 Min	% at +20°C 120 Hz Max	mΩ at 20°C 100 kHz Max	mA at +25°C 100 kHz	mA at +85°C 100 kHz	mA at +125°C 100 kHz	°C	Reflow Temp ≤ 260°C
10	15	C/6032-28	T495C156(1)010A(2)E475	1.5	6.0	475	481	433	192	125	1
10	22	A/3216-18	T495A226(1)010AT E1K2	2.2	8.0	1200	250	225	100	125	1
10	22	A/3216-18	T495A226(1)010AT E1K5	2.2	8.0	1500	224	202	90	125	1
10	22	B/3528-21	T495B226(1)010AT E400	2.2	6.0	400	461	415	184	125	1
10	22	B/3528-21	T495B226(1)010AT E500	2.2	6.0	500	412	371	165	125	1
10	22	B/3528-21	T495B226(1)010AT E700	2.2	6.0	700	348	313	139	125	1
10	22	B/3528-21	T495B226(1)010AT E800	2.2	6.0	800	326	293	130	125	1
10	22	B/3528-21	T495B226(1)010A(2)E2K3	2.2	6.0	2300	192	173	77	125	1
10	22	C/6032-28	T495C226(1)010A(2)E200	2.2	6.0	200	742	668	297	125	1
10	22	C/6032-28	T495C226(1)010A(2)E245	2.2	6.0	245	670	603	268	125	1
10	22	C/6032-28	T495C226(1)010A(2)E290	2.2	6.0	290	616	554	246	125	1
10	22	C/6032-28	T495C226(1)010A(2)E300	2.2	6.0	300	606	545	242	125	1
10	22	C/6032-28	T495C226(1)010A(2)E345	2.2	6.0	345	565	509	226	125	1
10	22	C/6032-28	T495C226(1)010A(2)E350	2.2	6.0	350	561	505	224	125	1
10	22	C/6032-28	T495C226(1)010A(2)E380	2.2	6.0	380	538	484	215	125	1
10	33	B/3528-21	T495B336(1)010A(2)E450	3.3	6.0	450	435	392	174	125	1
10	33	B/3528-21	T495B336(1)010A(2)E550	3.3	6.0	550	393	354	157	125	1
10	33	B/3528-21	T495B336(1)010A(2)E650	3.3	6.0	650	362	326	145	125	1
10	33	V/7343-20	T495V336(1)010A(2)E100	3.3	6.0	100	1118	1006	447	125	1
10	33	V/7343-20	T495V336(1)010A(2)E150	3.3	6.0	150	913	822	365	125	1
10	47	B/3528-21	T495B476(1)010A(2)E500	4.7	6.0	500	412	371	165	125	1
10	47	B/3528-21	T495B476(1)010A(2)E650	4.7	6.0	650	362	326	145	125	1
10	47	C/6032-28	T495C476(1)010A(2)E300	4.7	6.0	300	606	545	242	125	1
10	47	U/6032-15	T495U476(1)010A(2)E400	4.7	6.0	400	474	427	190	125	1
10	47	D/7343-31	T495D476(1)010A(2)E080	4.7	4.0	80	1369	1232	548	125	1
10	47	D/7343-31	T495D476(1)010A(2)E090	4.7	6.0	90	1291	1162	516	125	1
10	47	D/7343-31	T495D476(1)010A(2)E100	4.7	6.0	100	1225	1103	490	125	1
10	47	D/7343-31	T495D476(1)010A(2)E200	4.7	4.0	200	866	779	346	125	1
10	47	V/7343-20	T495V476(1)010A(2)E200	4.7	6.0	200	791	712	316	125	1
10	68	B/3528-21	T495B686(1)010A(2)E600	6.8	8.0	600	376	338	150	125	1
10	68	B/3528-21	T495B686(1)010A(2)E750	6.8	8.0	750	337	303	135	125	1
10	68	B/3528-21	T495B686(M)010A(2)E900	6.8	8.0	900	307	276	123	125	1
10	68	C/6032-28	T495C686(1)010A(2)E080	6.8	6.0	80	1173	1056	469	125	1
10	68	C/6032-28	T495C686(1)010A(2)E200	6.8	6.0	200	742	668	297	125	1
10	68	C/6032-28	T495C686(1)010A(2)E225	6.8	6.0	225	699	629	280	125	1
10	68	C/6032-28	T495C686(1)010A(2)E250	6.8	6.0	250	663	597	265	125	1
10	68	V/7343-20	T495V686(1)010A(2)E070	6.8	6.0	70	1336	1202	534	125	1
10	68	V/7343-20	T495V686(1)010A(2)E100	6.8	6.0	100	1118	1006	447	125	1
10	68	V/7343-20	T495V686(1)010A(2)E140	6.8	6.0	140	945	851	378	125	1
10	68	V/7343-20	T495V686(1)010A(2)E200	6.8	6.0	200	791	712	316	125	1
10	68	D/7343-31	T495D686(1)010A(2)E070	6.8	6.0	70	1464	1318	586	125	1
10	68	D/7343-31	T495D686(1)010A(2)E090	6.8	6.0	90	1291	1162	516	125	1
10	68	D/7343-31	T495D686(1)010A(2)E100	6.8	6.0	100	1225	1103	490	125	1
10	68	D/7343-31	T495D686(1)010A(2)E150	6.8	6.0	150	1000	900	400	125	1
10	68	X/7343-43	T495X686(1)010A(2)E150	6.8	4.0	150	1049	944	420	125	1
VDC at 85°C	µF	KEMET/EIA	(See below for part options)	µA +20°C Max/5 Min	% at +20°C 120 Hz Max	mΩ at 20°C 100 kHz Max	mA at +25°C 100 kHz	mA at +85°C 100 kHz	mA at +125°C 100 kHz	°C	Reflow Temp ≤ 260°C
Rated Voltage	Rated Cap	Case Code/ Case Size	KEMET Part Number	DC Leakage	DF	ESR	Maximum Allowable Ripple Current			Maximum Operating Temp	MSL

(1) To complete KEMET part number, insert M for ±20% or K for ±10%. Designates capacitance tolerance.

(2) To complete KEMET part number, insert T = 100% Matte Tin (Sn) Plated, G = Gold Plated, H = Standard Solder coated (SnPb 5% Pb minimum), N = Non-Magnetic 100% Tin (Sn) or M = Non-Magnetic (SnPb). Designates termination finish.

Refer to Ordering Information for additional detail.

Higher voltage ratings and tighter tolerance product including ESR may be substituted within the same size at KEMET's option. Voltage substitution will be marked with the higher voltage rating. Substitutions can include better than series.

Table 1 – Ratings & Part Number Reference cont'd

Rated Voltage	Rated Cap	Case Code/ Case Size	KEMET Part Number	DC Leakage	DF	ESR	Maximum Allowable Ripple Current			Maximum Operating Temp	MSL
							mA at +25°C 100 kHz	mA at +85°C 100 kHz	mA at +125°C 100 kHz		
VDC at 85°C	µF	KEMET/EIA	(See below for part options)	µA +20°C Max/5 Min	% at +20°C 120 Hz Max	mΩ at 20°C 100 kHz Max	mA at +25°C 100 kHz	mA at +85°C 100 kHz	mA at +125°C 100 kHz	°C	Reflow Temp ≤ 260°C
10	100	B/3528-21	T495B107(M)010A(2)E350	10.0	12.0	350	493	444	197	125	1
10	100	B/3528-21	T495B107(M)010A(2)E500	10.0	30.0	500	412	371	165	125	1
10	100	B/3528-21	T495B107(M)010A(2)E700	10.0	30.0	700	348	313	139	125	1
10	100	C/6032-28	T495C107(1)010A(2)E100	10.0	8.0	100	1050	945	420	125	1
10	100	C/6032-28	T495C107(1)010A(2)E150	10.0	8.0	150	856	812	542	125	1
10	100	C/6032-28	T495C107(1)010A(2)E180	10.0	8.0	180	782	704	313	125	1
10	100	C/6032-28	T495C107(1)010A(2)E200	10.0	8.0	200	742	668	297	125	1
10	100	C/6032-28	T495C107(1)010A(2)E250	10.0	8.0	250	663	597	265	125	1
10	100	U/6032-15	T495U107(1)010A(2)E150	10.0	8.0	150	775	698	310	125	1
10	100	W/7343-15	T495W107(1)010A(2)E200	10.0	8.0	200	949	854	380	125	1
10	100	V/7343-20	T495V107(1)010A(2)E100	10.0	8.0	100	1118	1006	447	125	1
10	100	V/7343-20	T495V107(1)010A(2)E150	10.0	8.0	150	913	822	365	125	1
10	100	V/7343-20	T495V107(1)010A(2)E200	10.0	8.0	200	791	712	316	125	1
10	100	D/7343-31	T495D107(1)010A(2)E050	10.0	8.0	50	1732	1559	693	125	1
10	100	D/7343-31	T495D107(1)010A(2)E065	10.0	8.0	65	1519	1367	608	125	1
10	100	D/7343-31	T495D107(1)010A(2)E080	10.0	8.0	80	1369	1232	548	125	1
10	100	D/7343-31	T495D107(1)010A(2)E100	10.0	8.0	100	1225	1103	490	125	1
10	100	D/7343-31	T495D107(1)010A(2)E120	10.0	8.0	120	1118	1006	447	125	1
10	100	D/7343-31	T495D107(1)010A(2)E125	10.0	8.0	125	1095	986	438	125	1
10	100	X/7343-43	T495X107(1)010A(2)E100	10.0	6.0	100	1285	1157	514	125	1
10	150	C/6032-28	T495C157(1)010A(2)E200	15.0	10.0	200	742	668	297	125	1
10	150	V/7343-20	T495V157(1)010A(2)E100	15.0	8.0	100	1118	1006	447	125	1
10	150	V/7343-20	T495V157(1)010A(2)E150	15.0	8.0	150	913	822	365	125	1
10	150	V/7343-20	T495V157(1)010A(2)E200	15.0	8.0	200	791	712	316	125	1
10	150	D/7343-31	T495D157(1)010A(2)E050	15.0	8.0	50	1732	1559	693	125	1
10	150	D/7343-31	T495D157(1)010A(2)E060	15.0	8.0	60	1581	1423	632	125	1
10	150	D/7343-31	T495D157(1)010A(2)E080	15.0	8.0	80	1369	1232	548	125	1
10	150	D/7343-31	T495D157(1)010A(2)E100	15.0	8.0	100	1225	1103	490	125	1
10	150	X/7343-43	T495X157(1)010A(2)E070	15.0	8.0	70	1535	1382	614	125	1
10	150	X/7343-43	T495X157(1)010A(2)E080	15.0	8.0	80	1436	1292	574	125	1
10	150	X/7343-43	T495X157(1)010A(2)E085	15.0	8.0	85	1393	1254	557	125	1
10	150	X/7343-43	T495X157(1)010A(2)E100	15.0	8.0	100	1285	1157	514	125	1
10	220	D/7343-31	T495D227(1)010A(2)E045	22.0	8.0	45	1826	1643	730	125	1
10	220	D/7343-31	T495D227(1)010A(2)E050	22.0	9.0	50	1732	1559	693	125	1
10	220	D/7343-31	T495D227(1)010A(2)E075	22.0	8.0	75	1414	1273	566	125	1
10	220	D/7343-31	T495D227(1)010A(2)E100	22.0	8.0	100	1225	1103	490	125	1
10	220	D/7343-31	T495D227(1)010A(2)E125	22.0	8.0	125	1095	986	438	125	1
10	220	V/7343-20	T495V227(1)010A(2)E150	22.0	10.0	150	913	822	365	125	1
10	220	V/7343-20	T495V227(1)010A(2)E200	22.0	10.0	200	791	712	316	125	1
10	220	X/7343-43	T495X227(1)010A(2)E045	22.0	8.0	45	1915	1724	766	125	1
10	220	X/7343-43	T495X227(1)010A(2)E050	22.0	8.0	50	1817	1635	727	125	1
10	220	X/7343-43	T495X227(1)010A(2)E060	22.0	8.0	60	1658	1492	663	125	1
10	220	X/7343-43	T495X227(1)010A(2)E070	22.0	8.0	70	1535	1382	614	125	1
10	220	X/7343-43	T495X227(1)010A(2)E080	22.0	8.0	80	1436	1292	574	125	1
10	220	X/7343-43	T495X227(1)010A(2)E100	22.0	8.0	100	1285	1157	514	125	1
VDC at 85°C	µF	KEMET/EIA	(See below for part options)	µA +20°C Max/5 Min	% at +20°C 120 Hz Max	mΩ at 20°C 100 kHz Max	mA at +25°C 100 kHz	mA at +85°C 100 kHz	mA at +125°C 100 kHz	°C	Reflow Temp ≤ 260°C
Rated Voltage	Rated Cap	Case Code/ Case Size	KEMET Part Number	DC Leakage	DF	ESR	Maximum Allowable Ripple Current			Maximum Operating Temp	MSL

(1) To complete KEMET part number, insert M for ±20% or K for ±10%. Designates capacitance tolerance.

(2) To complete KEMET part number, insert T = 100% Matte Tin (Sn) Plated, G = Gold Plated, H = Standard Solder coated (SnPb 5% Pb minimum), N = Non-Magnetic 100% Tin (Sn) or M = Non-Magnetic (SnPb). Designates termination finish.

Refer to Ordering Information for additional detail.

Higher voltage ratings and tighter tolerance product including ESR may be substituted within the same size at KEMET's option. Voltage substitution will be marked with the higher voltage rating. Substitutions can include better than series.

Table 1 – Ratings & Part Number Reference cont'd

Rated Voltage	Rated Cap	Case Code/ Case Size	KEMET Part Number	DC Leakage	DF	ESR	Maximum Allowable Ripple Current			Maximum Operating Temp	MSL
							mA at +25°C 100 kHz	mA at +85°C 100 kHz	mA at +125°C 100 kHz		
VDC at 85°C	µF	KEMET/EIA	(See below for part options)	µA +20°C Max/5 Min	% at +20°C 120 Hz Max	mΩ at 20°C 100 kHz Max	mA at +25°C 100 kHz	mA at +85°C 100 kHz	mA at +125°C 100 kHz	°C	Reflow Temp ≤ 260°C
10	330	D/7343-31	T495D337(1)010A(2)E100	33.0	8.0	100	1225	1103	490	125	1
10	330	D/7343-31	T495D337(1)010A(2)E125	33.0	10.0	125	1095	986	438	125	1
10	330	D/7343-31	T495D337(1)010A(2)E150	33.0	10.0	150	1000	900	400	125	1
10	330	X/7343-43	T495X337(1)010A(2)E035	33.0	10.0	35	2171	1954	868	125	1
10	330	X/7343-43	T495X337(1)010A(2)E040	33.0	10.0	40	2031	1828	812	125	1
10	330	X/7343-43	T495X337(1)010A(2)E050	33.0	10.0	50	1817	1635	727	125	1
10	330	X/7343-43	T495X337(1)010A(2)E060	33.0	10.0	60	1658	1492	663	125	1
10	330	X/7343-43	T495X337(1)010A(2)E080	33.0	10.0	80	1436	1292	574	125	1
10	330	X/7343-43	T495X337(1)010A(2)E100	33.0	10.0	100	1285	1157	514	125	1
10	330	E/7360-38	T495E337(1)010A(2)E040	33.0	8.0	40	2236	2012	894	125	1
10	330	E/7360-38	T495E337(1)010A(2)E060	33.0	10.0	60	1826	1643	730	125	1
10	330	E/7360-38	T495E337(1)010A(2)E100	33.0	10.0	100	1414	1273	566	125	1
10	470	X/7343-43	T495X477(1)010A(2)E045	47.0	10.0	45	1915	1724	766	125	1
10	470	X/7343-43	T495X477(1)010A(2)E050	47.0	10.0	50	1817	1635	727	125	1
10	470	X/7343-43	T495X477(1)010A(2)E060	47.0	10.0	60	1658	1492	663	125	1
10	470	X/7343-43	T495X477(1)010A(2)E080	47.0	10.0	80	1436	1292	574	125	1
10	470	X/7343-43	T495X477(1)010A(2)E100	47.0	10.0	100	1285	1157	514	125	1
10	470	X/7343-43	T495X477(1)010A(2)E200	47.0	10.0	200	908	817	363	125	1
10	470	E/7360-38	T495E477(1)010A(2)E040	47.0	10.0	40	2236	2012	894	125	1
10	470	E/7360-38	T495E477(1)010A(2)E060	47.0	10.0	60	1826	1643	730	125	1
10	470	E/7360-38	T495E477(1)010A(2)E100	47.0	10.0	100	1414	1273	566	125	1
16	1.0	A/3216-18	T495A105(1)016A(2)E5K0	0.5	6.0	5000	122	110	49	125	1
16	1.5	A/3216-18	T495A155(1)016A(2)E5K0	0.5	6.0	5000	122	110	49	125	1
16	2.2	A/3216-18	T495A225(1)016A(2)E2K5	0.5	6.0	2500	173	156	69	125	1
16	2.2	A/3216-18	T495A225(1)016A(2)E1K8	0.5	6.0	1800	204	184	82	125	1
16	3.3	A/3216-18	T495A335(1)016A(2)E3K0	0.5	6.0	3000	158	142	63	125	1
16	3.3	B/3528-21	T495B335(1)016A(2)E2K0	0.5	6.0	2000	206	185	82	125	1
16	4.7	A/3216-18	T495A475(1)016A(2)E2K0	0.8	6.0	2000	194	175	78	125	1
16	4.7	B/3528-21	T495B475(1)016A(2)E700	0.8	6.0	700	348	313	139	125	1
16	4.7	B/3528-21	T495B475(1)016A(2)E800	0.8	6.0	800	326	293	130	125	1
16	4.7	B/3528-21	T495B475(1)016A(2)E1K0	0.8	6.0	1000	292	263	117	125	1
16	4.7	B/3528-21	T495B475(1)016A(2)E1K5	0.8	6.0	1500	238	214	95	125	1
16	6.8	B/3528-21	T495B685(1)016A(2)E1K2	1.1	6.0	1200	266	239	106	125	1
16	6.8	C/6032-28	T495C685(1)016A(2)E750	1.1	6.0	750	383	345	153	125	1
16	10	A/3216-18	T495A106(1)016A(2)E1K7	1.6	6.0	1700	210	189	84	125	1
16	10	B/3528-21	T495B106(1)016A(2)E500	1.6	6.0	500	412	371	165	125	1
16	10	B/3528-21	T495B106(1)016A(2)E650	1.6	6.0	650	362	326	145	125	1
16	10	B/3528-21	T495B106(1)016A(2)E800	1.6	6.0	800	326	293	130	125	1
16	10	B/3528-21	T495B106(1)016A(2)E2K5	1.6	6.0	2500	184	166	74	125	1
16	10	T/3528-12	T495T106(M)016A(2)E4K0	1.6	8.0	4000	132	119	53	125	1
16	15	A/3216-18	T495A156(1)016A(2)E2K5	2.4	8.0	2500	173	156	69	125	1
16	15	B/3528-21	T495B156(1)016A(2)E500	2.4	6.0	500	412	371	165	125	1
16	15	B/3528-21	T495B156(1)016A(2)E650	2.4	6.0	650	362	326	145	125	1
16	15	B/3528-21	T495B156(1)016A(2)E800	2.4	6.0	800	326	293	130	125	1
16	15	C/6032-28	T495C156(1)016A(2)E400	2.4	6.0	400	524	472	210	125	1
VDC at 85°C	µF	KEMET/EIA	(See below for part options)	µA +20°C Max/5 Min	% at +20°C 120 Hz Max	mΩ at 20°C 100 kHz Max	mA at +25°C 100 kHz	mA at +85°C 100 kHz	mA at +125°C 100 kHz	°C	Reflow Temp ≤ 260°C
Rated Voltage	Rated Cap	Case Code/ Case Size	KEMET Part Number	DC Leakage	DF	ESR	Maximum Allowable Ripple Current			Maximum Operating Temp	MSL

(1) To complete KEMET part number, insert M for ±20% or K for ±10%. Designates capacitance tolerance.

(2) To complete KEMET part number, insert T = 100% Matte Tin (Sn) Plated, G = Gold Plated, H = Standard Solder coated (SnPb 5% Pb minimum), N = Non-Magnetic 100% Tin (Sn) or M = Non-Magnetic (SnPb). Designates termination finish.

Refer to Ordering Information for additional detail.

Higher voltage ratings and tighter tolerance product including ESR may be substituted within the same size at KEMET's option. Voltage substitution will be marked with the higher voltage rating. Substitutions can include better than series.

Table 1 – Ratings & Part Number Reference cont'd

Rated Voltage	Rated Cap	Case Code/ Case Size	KEMET Part Number	DC Leakage	DF	ESR	Maximum Allowable Ripple Current			Maximum Operating Temp	MSL
							mA at +25°C 100 kHz	mA at +85°C 100 kHz	mA at +125°C 100 kHz		
VDC at 85°C	µF	KEMET/EIA	(See below for part options)	µA +20°C Max/5 Min	% at +20°C 120 Hz Max	mΩ at 20°C 100 kHz Max	mA at +25°C 100 kHz	mA at +85°C 100 kHz	mA at +125°C 100 kHz	°C	Reflow Temp ≤ 260°C
16	22	B/3528-21	T495B226(1)016A(2)E600	3.5	6.0	600	376	338	150	125	1
16	22	B/3528-21	T495B226(1)016A(2)E700	3.5	6.0	700	348	313	139	125	1
16	22	C/6032-28	T495C226(1)016A(2)E300	3.5	6.0	300	606	545	242	125	1
16	22	C/6032-28	T495C226(1)016A(2)E350	3.5	6.0	350	561	505	224	125	1
16	22	C/6032-28	T495C226(1)016A(2)E500	3.5	6.0	500	469	422	188	125	1
16	22	U/6032-15	T495U226(1)016A(2)E500	3.5	6.0	500	424	382	170	125	1
16	33	C/6032-28	T495C336(1)016A(2)E200	5.3	6.0	200	742	668	297	125	1
16	33	C/6032-28	T495C336(1)016A(2)E225	5.3	6.0	225	699	629	280	125	1
16	33	C/6032-28	T495C336(1)016A(2)E230	5.3	6.0	230	692	623	277	125	1
16	33	C/6032-28	T495C336(1)016A(2)E275	5.3	6.0	275	632	569	253	125	1
16	33	C/6032-28	T495C336(1)016A(2)E300	5.3	6.0	300	606	545	242	125	1
16	33	U/6032-15	T495U336(1)016A(2)E200	5.3	6.0	200	671	604	268	125	1
16	33	U/6032-15	T495U336(1)016A(2)E400	5.3	6.0	400	474	427	190	125	1
16	33	B/3528-21	T495B336(1)016A(2)E350	5.3	6.0	350	493	444	197	125	1
16	33	D/7343-31	T495D336(1)016A(2)E150	5.3	6.0	150	1000	900	400	125	1
16	33	D/7343-31	T495D336(1)016A(2)E175	5.3	6.0	175	926	833	370	125	1
16	33	D/7343-31	T495D336(1)016A(2)E200	5.3	6.0	200	866	779	346	125	1
16	33	D/7343-31	T495D336(1)016A(2)E225	5.3	4.0	225	816	734	326	125	1
16	33	D/7343-31	T495D336(1)016A(2)E250	5.3	6.0	250	775	698	310	125	1
16	47	C/6032-28	T495C476(1)016A(2)E300	7.5	6.0	300	606	545	242	125	1
16	47	C/6032-28	T495C476(1)016A(2)E350	7.5	6.0	350	561	505	224	125	1
16	47	D/7343-31	T495D476(1)016A(2)E080	7.5	6.0	80	1369	1232	548	125	1
16	47	D/7343-31	T495D476(1)016A(2)E100	7.5	6.0	100	1225	1103	490	125	1
16	47	D/7343-31	T495D476(1)016A(2)E150	7.5	6.0	150	1000	900	400	125	1
16	47	D/7343-31	T495D476(1)016A(2)E180	7.5	6.0	180	913	822	365	125	1
16	47	D/7343-31	T495D476(1)016A(2)E800	7.5	6.0	800	433	390	173	125	1
16	68	C/6032-28	T495C686(1)016A(2)E250	10.9	6.0	250	663	597	265	125	1
16	68	C/6032-28	T495C686(1)016A(2)E200	10.9	6.0	200	742	668	297	125	1
16	68	C/6032-28	T495C686(1)016A(2)E180	10.9	6.0	180	782	704	313	125	1
16	68	V/7343-20	T495V686(1)016A(2)E180	10.9	6.0	180	833	750	333	125	1
16	68	V/7343-20	T495V686(1)016A(2)E250	10.9	6.0	250	707	636	283	125	1
16	68	V/7343-20	T495V686(1)016A(2)E300	10.9	6.0	300	645	581	258	125	1
16	68	D/7343-31	T495D686(1)016A(2)E070	10.9	6.0	70	1464	1318	586	125	1
16	68	D/7343-31	T495D686(1)016A(2)E100	10.9	6.0	100	1225	1103	490	125	1
16	68	D/7343-31	T495D686(1)016A(2)E150	10.9	6.0	150	1000	900	400	125	1
16	68	X/7343-43	T495X686(1)016A(2)E150	10.9	5.0	150	1049	944	420	125	1
16	100	C/6032-28	T495C107(1)016A(2)E200	16.0	10.0	200	742	668	297	125	1
16	100	D/7343-31	T495D107(1)016A(2)E060	16.0	8.0	60	1581	1423	632	125	1
16	100	D/7343-31	T495D107(1)016A(2)E100	16.0	8.0	100	1225	1103	490	125	1
16	100	D/7343-31	T495D107(1)016A(2)E125	16.0	8.0	125	1095	986	438	125	1
16	100	D/7343-31	T495D107(1)016A(2)E130	16.0	8.0	130	1074	967	430	125	1
16	100	D/7343-31	T495D107(1)016A(2)E150	16.0	8.0	150	1000	900	400	125	1
16	100	D/7343-31	T495D107(1)016A(2)E800	16.0	8.0	800	433	390	173	125	1
16	100	V/7343-20	T495V107(1)016A(2)E250	16.0	8.0	250	707	636	283	125	1
16	100	X/7343-43	T495X107(1)016A(2)E080	16.0	8.0	80	1436	1292	574	125	1
VDC at 85°C	µF	KEMET/EIA	(See below for part options)	µA +20°C Max/5 Min	% at +20°C 120 Hz Max	mΩ at 20°C 100 kHz Max	mA at +25°C 100 kHz	mA at +85°C 100 kHz	mA at +125°C 100 kHz	°C	Reflow Temp ≤ 260°C
Rated Voltage	Rated Cap	Case Code/ Case Size	KEMET Part Number	DC Leakage	DF	ESR	Maximum Allowable Ripple Current			Maximum Operating Temp	MSL

(1) To complete KEMET part number, insert M for ±20% or K for ±10%. Designates capacitance tolerance.

(2) To complete KEMET part number, insert T = 100% Matte Tin (Sn) Plated, G = Gold Plated, H = Standard Solder coated (SnPb 5% Pb minimum), N = Non-Magnetic 100% Tin (Sn) or M = Non-Magnetic (SnPb). Designates termination finish.

Refer to Ordering Information for additional detail.

Higher voltage ratings and tighter tolerance product including ESR may be substituted within the same size at KEMET's option. Voltage substitution will be marked with the higher voltage rating. Substitutions can include better than series.

Table 1 – Ratings & Part Number Reference cont'd

Rated Voltage	Rated Cap	Case Code/ Case Size	KEMET Part Number	DC Leakage	DF	ESR	Maximum Allowable Ripple Current			Maximum Operating Temp	MSL
							mA at +25°C 100 kHz	mA at +85°C 100 kHz	mA at +125°C 100 kHz		
VDC at 85°C	µF	KEMET/EIA	(See below for part options)	µA +20°C Max/5 Min	% at +20°C 120 Hz Max	mΩ at 20°C 100 kHz Max	mA at +25°C 100 kHz	mA at +85°C 100 kHz	mA at +125°C 100 kHz	°C	Reflow Temp ≤ 260°C
16	100	X/7343-43	T495X107(1)016A(2)E100	16.0	8.0	100	1285	1157	514	125	1
16	150	B/3528-21	T495B157(1)016A(2)E800	24.0	6.0	800	326	293	130	125	1
16	150	D/7343-31	T495D157(M)016A(2)E060	24.0	12.0	60	1581	1423	632	125	1
16	150	D/7343-31	T495D157(1)016A(2)E085	24.0	8.0	85	1328	1195	531	125	1
16	150	D/7343-31	T495D157(1)016A(2)E100	24.0	8.0	100	1225	1103	490	125	1
16	150	D/7343-31	T495D157(1)016A(2)E125	24.0	8.0	125	1095	986	438	125	1
16	150	D/7343-31	T495D157(1)016A(2)E130	24.0	8.0	130	1074	967	430	125	1
16	150	D/7343-31	T495D157(1)016A(2)E150	24.0	8.0	150	1000	900	400	125	1
16	150	X/7343-43	T495X157(1)016A(2)E075	24.0	8.0	75	1483	1335	593	125	1
16	150	X/7343-43	T495X157(1)016A(2)E100	24.0	8.0	100	1285	1157	514	125	1
16	220	D/7343-31	T495D227(1)016A(2)E150	35.2	12.0	150	1000	900	400	125	1
16	220	D/7343-31	T495D227(1)016A(2)E200	35.2	12.0	200	866	779	346	125	1
16	220	D/7343-31	T495D227(1)016A(2)E220	35.2	12.0	220	826	743	330	125	1
16	220	X/7343-43	T495X227(1)016A(2)E100	35.2	8.0	100	1285	1157	514	125	1
16	220	E/7360-38	T495E227(1)016A(2)E050	35.2	12.0	50	2000	1800	800	125	1
16	220	E/7360-38	T495E227(1)016A(2)E075	35.2	8.0	75	1633	1470	653	125	1
16	220	E/7360-38	T495E227(1)016A(2)E100	35.2	7.2	100	1414	1273	566	125	1
16	220	E/7360-38	T495E227(1)016A(2)E150	35.2	7.2	150	1155	1040	462	125	1
20	1	A/3216-18	T495A105(1)020A(2)E3K0	0.5	4.0	3000	158	142	63	125	1
20	1	A/3216-18	T495A105(1)020A(2)E5K0	0.5	4.0	5000	122	110	49	125	1
20	2.2	A/3216-18	T495A225(1)020A(2)E3K0	0.5	6.0	3000	158	142	63	125	1
20	4.7	A/3216-18	T495A475(1)020A(2)E1K8	0.9	6.0	1800	204	184	82	125	1
20	4.7	A/3216-18	T495A475(1)020A(2)E2K0	0.9	6.0	2000	194	175	78	125	1
20	4.7	B/3528-21	T495B475(1)020A(2)E750	0.9	6.0	750	337	303	135	125	1
20	4.7	B/3528-21	T495B475(1)020A(2)E1K0	0.9	6.0	1000	292	263	117	125	1
20	6.8	C/6032-28	T495C685(1)020A(2)E480	1.4	6.0	480	479	431	192	125	1
20	10	B/3528-21	T495B106(1)020A(2)E1K0	2.0	6.0	1000	292	263	117	125	1
20	10	B/3528-21	T495B106(1)020A(2)E800	2.0	6.0	800	326	293	130	125	1
20	10	C/6032-28	T495C106(1)020A(2)E300	2.0	6.0	300	606	545	242	125	1
20	10	C/6032-28	T495C106(1)020A(2)E350	2.0	6.0	350	561	505	224	125	1
20	10	C/6032-28	T495C106(1)020A(2)E400	2.0	6.0	400	524	472	210	125	1
20	10	C/6032-28	T495C106(1)020A(2)E450	2.0	6.0	450	494	445	198	125	1
20	10	C/6032-28	T495C106(1)020A(2)E475	2.0	6.0	475	481	433	192	125	1
20	15	C/6032-28	T495C156(1)020A(2)E375	3.0	6.0	375	542	488	217	125	1
20	15	C/6032-28	T495C156(1)020A(2)E400	3.0	6.0	400	524	472	210	125	1
20	15	D/7343-31	T495D156(1)020A(2)E275	3.0	4.0	275	739	665	296	125	1
20	15	D/7343-31	T495D156(1)020A(2)E1K2	3.0	4.0	1200	354	319	142	125	1
20	22	D/7343-31	T495D226(1)020A(2)E180	4.4	4.0	180	913	822	365	125	1
20	22	D/7343-31	T495D226(1)020A(2)E200	4.4	4.0	200	866	779	346	125	1
20	22	D/7343-31	T495D226(1)020A(2)E225	4.4	4.0	225	816	734	326	125	1
20	22	V/7343-20	T495V226(1)020A(2)E400	4.4	6.0	400	559	503	224	125	1
20	33	C/6032-28	T495C336(1)020A(2)E200	6.6	6.0	200	742	668	297	125	1
20	33	D/7343-31	T495D336(1)020A(2)E100	6.6	6.0	100	1225	1103	490	125	1
20	33	D/7343-31	T495D336(1)020A(2)E150	6.6	6.0	150	1000	900	400	125	1
20	33	D/7343-31	T495D336(1)020A(2)E200	6.6	6.0	200	866	779	346	125	1
VDC at 85°C	µF	KEMET/EIA	(See below for part options)	µA +20°C Max/5 Min	% at +20°C 120 Hz Max	mΩ at 20°C 100 kHz Max	mA at +25°C 100 kHz	mA at +85°C 100 kHz	mA at +125°C 100 kHz	°C	Reflow Temp ≤ 260°C
Rated Voltage	Rated Cap	Case Code/ Case Size	KEMET Part Number	DC Leakage	DF	ESR	Maximum Allowable Ripple Current			Maximum Operating Temp	MSL

(1) To complete KEMET part number, insert M for ±20% or K for ±10%. Designates capacitance tolerance.

(2) To complete KEMET part number, insert T = 100% Matte Tin (Sn) Plated, G = Gold Plated, H = Standard Solder coated (SnPb 5% Pb minimum), N = Non-Magnetic 100% Tin (Sn) or M = Non-Magnetic (SnPb). Designates termination finish.

Refer to Ordering Information for additional detail.

Higher voltage ratings and tighter tolerance product including ESR may be substituted within the same size at KEMET's option. Voltage substitution will be marked with the higher voltage rating. Substitutions can include better than series.

Table 1 – Ratings & Part Number Reference cont'd

Rated Voltage	Rated Cap	Case Code/ Case Size	KEMET Part Number	DC Leakage	DF	ESR	Maximum Allowable Ripple Current			Maximum Operating Temp	MSL
							mA at +25°C 100 kHz	mA at +85°C 100 kHz	mA at +125°C 100 kHz		
VDC at 85°C	µF	KEMET/EIA	(See below for part options)	µA +20°C Max/5 Min	% at +20°C 120 Hz Max	mΩ at 20°C 100 kHz Max	mA at +25°C 100 kHz	mA at +85°C 100 kHz	mA at +125°C 100 kHz	°C	Reflow Temp ≤ 260°C
20	33	X/7343-43	T495X336(1)020A(2)E200	6.6	6.0	200	908	817	363	125	1
20	47	D/7343-31	T495D476(1)020A(2)E075	9.4	6.0	75	1414	1273	566	125	1
20	47	D/7343-31	T495D476(1)020A(2)E100	9.4	6.0	100	1225	1103	490	125	1
20	47	D/7343-31	T495D476(1)020A(2)E150	9.4	6.0	150	1000	900	400	125	1
20	47	D/7343-31	T495D476(1)020A(2)E175	9.4	6.0	175	926	833	370	125	1
20	47	D/7343-31	T495D476(1)020A(2)E200	9.4	6.0	200	866	779	346	125	1
20	47	D/7343-31	T495D476(1)020A(2)E250	9.4	6.0	250	775	698	310	125	1
20	47	X/7343-43	T495X476(1)020A(2)E065	9.4	8.0	65	1593	1434	637	125	1
20	47	X/7343-43	T495X476(1)020A(2)E070	9.4	6.0	70	1535	1382	614	125	1
20	47	X/7343-43	T495X476(1)020A(2)E100	9.4	6.0	100	1285	1157	514	125	1
20	47	X/7343-43	T495X476(1)020A(2)E125	9.4	6.0	125	1149	1034	460	125	1
20	47	X/7343-43	T495X476(1)020A(2)E130	9.4	6.0	130	1127	1014	451	125	1
20	47	X/7343-43	T495X476(1)020A(2)E150	9.4	4.0	150	1049	944	420	125	1
20	68	C/6032-28	T495C686(1)020A(2)E250	13.6	8.0	250	663	597	265	125	1
20	68	D/7343-31	T495D686(1)020A(2)E070	13.6	6.0	70	1464	1318	586	125	1
20	68	D/7343-31	T495D686(1)020A(2)E100	13.6	6.0	100	1225	1103	490	125	1
20	68	D/7343-31	T495D686(1)020A(2)E150	13.6	6.0	150	1000	900	400	125	1
20	68	D/7343-31	T495D686(1)020A(2)E200	13.6	6.0	200	866	779	346	125	1
20	68	D/7343-31	T495D686(1)020A(2)E300	13.6	6.0	300	707	636	283	125	1
20	68	X/7343-43	T495X686(1)020A(2)E120	13.6	6.0	120	1173	1056	469	125	1
20	68	X/7343-43	T495X686(1)020A(2)E130	13.6	6.0	130	1127	1014	451	125	1
20	68	X/7343-43	T495X686(1)020A(2)E150	13.6	6.0	150	1049	944	420	125	1
20	68	X/7343-43	T495X686(1)020A(2)E200	13.6	6.0	200	908	817	363	125	1
20	100	D/7343-31	T495D107(1)020A(2)E200	20.0	6.0	200	866	779	346	125	1
20	100	X/7343-43	T495X107(1)020A(2)E100	20.0	6.0	100	1285	1157	514	125	1
20	100	X/7343-43	T495X107(1)020A(2)E150	20.0	8.0	150	1049	944	420	125	1
20	100	E/7360-38	T495E107(1)020A(2)E060	20.0	8.0	60	1826	1643	730	125	1
20	100	E/7360-38	T495E107(1)020A(2)E085	20.0	8.0	85	1534	1381	614	125	1
20	100	E/7360-38	T495E107(1)020A(2)E100	20.0	8.0	100	1414	1273	566	125	1
20	100	E/7360-38	T495E107(1)020A(2)E200	20.0	8.0	200	1000	900	400	125	1
20	150	E/7360-38	T495E157(1)020A(2)E080	30.0	8.0	80	1581	1423	632	125	1
25	0.47	A/3216-18	T495A474(1)025A(2)E4K5	0.5	4.0	4500	129	116	52	125	1
25	0.47	A/3216-18	T495A474(1)025A(2)E7K0	0.5	4.0	7000	104	94	42	125	1
25	1	A/3216-18	T495A105(1)025A(2)E2K5	0.5	4.0	2500	173	156	69	125	1
25	1	A/3216-18	T495A105(1)025A(2)E3K0	0.5	4.0	3000	158	142	63	125	1
25	1	A/3216-18	T495A105(1)025A(2)E4K0	0.5	4.0	4000	137	123	55	125	1
25	1	A/3216-18	T495A105(1)025A(2)E5K0	0.5	4.0	5000	122	110	49	125	1
25	1.5	A/3216-18	T495A155(1)025A(2)E3K0	0.5	6.0	3000	158	142	63	125	1
25	2.2	B/3528-21	T495B225(1)025A(2)E1K2	0.6	4.0	1200	266	239	106	125	1
25	2.2	C/6032-28	T495C225(1)025A(2)E1K3	0.6	6.0	1300	291	262	116	125	1
25	3.3	B/3528-21	T495B335(1)025A(2)E1K2	0.8	6.0	1200	266	239	106	125	1
25	3.3	C/6032-28	T495C335(1)025A(2)E750	0.8	6.0	750	383	345	153	125	1
25	4.7	C/6032-28	T495C475(1)025A(2)E530	1.2	6.0	530	456	410	182	125	1
25	4.7	C/6032-28	T495C475(1)025A(2)E575	1.2	6.0	575	437	393	175	125	1
25	4.7	B/3528-21	T495B475(1)025A(2)E700	1.2	6.0	700	348	313	139	125	1
VDC at 85°C	µF	KEMET/EIA	(See below for part options)	µA +20°C Max/5 Min	% at +20°C 120 Hz Max	mΩ at 20°C 100 kHz Max	mA at +25°C 100 kHz	mA at +85°C 100 kHz	mA at +125°C 100 kHz	°C	Reflow Temp ≤ 260°C
Rated Voltage	Rated Cap	Case Code/ Case Size	KEMET Part Number	DC Leakage	DF	ESR	Maximum Allowable Ripple Current			Maximum Operating Temp	MSL

(1) To complete KEMET part number, insert M for ±20% or K for ±10%. Designates capacitance tolerance.

(2) To complete KEMET part number, insert T = 100% Matte Tin (Sn) Plated, G = Gold Plated, H = Standard Solder coated (SnPb 5% Pb minimum), N = Non-Magnetic 100% Tin (Sn) or M = Non-Magnetic (SnPb). Designates termination finish.

Refer to Ordering Information for additional detail.

Higher voltage ratings and tighter tolerance product including ESR may be substituted within the same size at KEMET's option. Voltage substitution will be marked with the higher voltage rating. Substitutions can include better than series.

Table 1 – Ratings & Part Number Reference cont'd

Rated Voltage	Rated Cap	Case Code/ Case Size	KEMET Part Number	DC Leakage	DF	ESR	Maximum Allowable Ripple Current			Maximum Operating Temp	MSL
							mA at +25°C 100 kHz	mA at +85°C 100 kHz	mA at +125°C 100 kHz		
VDC at 85°C	µF	KEMET/EIA	(See below for part options)	µA +20°C Max/5 Min	% at +20°C 120 Hz Max	mΩ at 20°C 100 kHz Max	mA at +25°C 100 kHz	mA at +85°C 100 kHz	mA at +125°C 100 kHz	°C	Reflow Temp ≤ 260°C
25	4.7	B/3528-21	T495B475(1)025A(2)E750	1.2	6.0	750	337	303	135	125	1
25	4.7	B/3528-21	T495B475(1)025A(2)E800	1.2	6.0	800	326	293	130	125	1
25	4.7	B/3528-21	T495B475(1)025A(2)E900	1.2	6.0	900	307	276	123	125	1
25	4.7	B/3528-21	T495B475(1)025A(2)E1K0	1.2	6.0	1000	292	263	117	125	1
25	6.8	B/3528-21	T495B685(1)025A(2)E1K0	1.7	6.0	1000	292	263	117	125	1
25	6.8	B/3528-21	T495B685(1)025A(2)E1K5	1.7	6.0	1500	238	214	95	125	1
25	6.8	C/6032-28	T495C685(1)025A(2)E400	1.7	6.0	400	524	472	210	125	1
25	6.8	C/6032-28	T495C685(1)025A(2)E490	1.7	6.0	490	474	427	190	125	1
25	6.8	C/6032-28	T495C685(1)025A(2)E500	1.7	6.0	500	469	422	188	125	1
25	10	B/3528-21	T495B106(1)025A(2)E750	2.5	6.0	750	337	303	135	125	1
25	10	C/6032-28	T495C106(1)025A(2)E275	2.5	6.0	275	632	569	253	125	1
25	10	C/6032-28	T495C106(1)025A(2)E300	2.5	6.0	300	606	545	242	125	1
25	10	C/6032-28	T495C106(1)025A(2)E450	2.5	6.0	450	494	445	198	125	1
25	10	D/7343-31	T495D106(1)025A(2)E1K2	2.5	6.0	1200	354	319	142	125	1
25	15	C/6032-28	T495C156(1)025A(2)E300	3.8	6.0	300	606	545	242	125	1
25	15	D/7343-31	T495D156(1)025A(2)E100	3.8	6.0	100	1225	1103	490	125	1
25	15	D/7343-31	T495D156(1)025A(2)E230	3.8	4.0	230	808	727	323	125	1
25	15	D/7343-31	T495D156(1)025A(2)E275	3.8	6.0	275	739	665	296	125	1
25	15	V/7343-20	T495V156(1)025A(2)E500	3.8	6.0	500	500	450	200	125	1
25	15	X/7343-43	T495X156(1)025A(2)E200	3.8	4.0	200	908	817	363	125	1
25	22	C/6032-28	T495C226(1)025A(2)E275	5.5	6.0	275	632	569	253	125	1
25	22	C/6032-28	T495C226(1)025A(2)E280	5.5	6.0	280	627	564	251	125	1
25	22	C/6032-28	T495C226(1)025A(2)E300	5.5	8.0	300	606	545	242	125	1
25	22	C/6032-28	T495C226(1)025A(2)E900	5.5	6.0	900	350	315	140	125	1
25	22	D/7343-31	T495D226(1)025A(2)E200	5.5	6.0	200	866	779	346	125	1
25	22	D/7343-31	T495D226(1)025A(2)E230	5.5	6.0	230	808	727	323	125	1
25	22	X/7343-43	T495X226(1)025A(2)E225	5.5	4.0	225	856	770	342	125	1
25	33	D/7343-31	T495D336(1)025A(2)E090	8.3	6.0	90	1291	1162	516	125	1
25	33	D/7343-31	T495D336(1)025A(2)E100	8.3	6.0	100	1225	1103	490	125	1
25	33	D/7343-31	T495D336(1)025A(2)E150	8.3	6.0	150	1000	900	400	125	1
25	33	D/7343-31	T495D336(1)025A(2)E200	8.3	6.0	200	866	779	346	125	1
25	33	D/7343-31	T495D336(1)025A(2)E225	8.3	6.0	225	816	734	326	125	1
25	33	D/7343-31	T495D336(1)025A(2)E230	8.3	6.0	230	808	727	323	125	1
25	33	D/7343-31	T495D336(1)025A(2)E300	8.3	6.0	300	707	636	283	125	1
25	33	X/7343-43	T495X336(1)025A(2)E100	8.3	4.0	100	1285	1157	514	125	1
25	33	X/7343-43	T495X336(1)025A(2)E175	8.3	4.0	175	971	874	388	125	1
25	33	X/7343-43	T495X336(1)025A(2)E180	8.3	4.0	180	957	861	383	125	1
25	33	X/7343-43	T495X336(1)025A(2)E200	8.3	4.0	200	908	817	363	125	1
25	47	X/7343-43	T495X476(1)025A(2)E080	11.8	6.0	80	1436	1292	574	125	1
25	47	X/7343-43	T495X476(1)025A(2)E100	11.8	6.0	100	1285	1157	514	125	1
25	47	X/7343-43	T495X476(1)025A(2)E120	11.8	6.0	120	1173	1056	469	125	1
25	47	X/7343-43	T495X476(1)025A(2)E150	11.8	6.0	150	1049	944	420	125	1
25	47	X/7343-43	T495X476(1)025A(2)E185	11.8	6.0	185	944	850	378	125	1
25	47	X/7343-43	T495X476(1)025A(2)E200	11.8	6.0	200	908	817	363	125	1
25	47	D/7343-31	T495D476(1)025A(2)E100	11.8	6.0	100	1225	1103	490	125	1
VDC at 85°C	µF	KEMET/EIA	(See below for part options)	µA +20°C Max/5 Min	% at +20°C 120 Hz Max	mΩ at 20°C 100 kHz Max	mA at +25°C 100 kHz	mA at +85°C 100 kHz	mA at +125°C 100 kHz	°C	Reflow Temp ≤ 260°C
Rated Voltage	Rated Cap	Case Code/ Case Size	KEMET Part Number	DC Leakage	DF	ESR	Maximum Allowable Ripple Current			Maximum Operating Temp	MSL

(1) To complete KEMET part number, insert M for ±20% or K for ±10%. Designates capacitance tolerance.

(2) To complete KEMET part number, insert T = 100% Matte Tin (Sn) Plated, G = Gold Plated, H = Standard Solder coated (SnPb 5% Pb minimum), N = Non-Magnetic 100% Tin (Sn) or M = Non-Magnetic (SnPb). Designates termination finish.

Refer to Ordering Information for additional detail.

Higher voltage ratings and tighter tolerance product including ESR may be substituted within the same size at KEMET's option. Voltage substitution will be marked with the higher voltage rating. Substitutions can include better than series.

Table 1 – Ratings & Part Number Reference cont'd

Rated Voltage	Rated Cap	Case Code/ Case Size	KEMET Part Number	DC Leakage	DF	ESR	Maximum Allowable Ripple Current			Maximum Operating Temp	MSL
							mA at +25°C 100 kHz	mA at +85°C 100 kHz	mA at +125°C 100 kHz		
VDC at 85°C	µF	KEMET/EIA	(See below for part options)	µA +20°C Max/5 Min	% at +20°C 120 Hz Max	mΩ at 20°C 100 kHz Max	mA at +25°C 100 kHz	mA at +85°C 100 kHz	mA at +125°C 100 kHz	°C	Reflow Temp ≤ 260°C
25	47	D/7343-31	T495D476(1)025A(2)E120	11.8	6.0	120	1118	1006	447	125	1
25	47	D/7343-31	T495D476(1)025A(2)E130	11.8	6.0	130	1074	967	430	125	1
25	47	D/7343-31	T495D476(1)025A(2)E150	11.8	6.0	150	1000	900	400	125	1
25	47	D/7343-31	T495D476(1)025A(2)E250	11.8	6.0	250	775	698	310	125	1
25	68	D/7343-31	T495D686(1)025A(2)E150	17.0	10.0	150	1000	900	400	125	1
25	68	D/7343-31	T495D686(1)025A(2)E200	17.0	10.0	200	866	779	346	125	1
25	68	X/7343-43	T495X686(1)025A(2)E125	17.0	6.0	125	1149	1034	460	125	1
25	68	X/7343-43	T495X686(1)025A(2)E130	17.0	6.0	130	1127	1014	451	125	1
25	68	X/7343-43	T495X686(1)025A(2)E150	17.0	6.0	150	1049	944	420	125	1
25	68	X/7343-43	T495X686(1)025A(2)E200	17.0	6.0	200	908	817	363	125	1
25	100	X/7343-43	T495X107(1)025A(2)E150	25.0	10.0	150	1049	944	420	125	1
25	100	E/7360-38	T495E107(1)025A(2)E100	25.0	8.0	100	1414	1273	566	125	1
35	0.33	A/3216-18	T495A334(1)035A(2)E6K0	0.5	4.0	6000	112	101	45	125	1
35	0.47	A/3216-18	T495A474(1)035A(2)E4K0	0.5	4.0	4000	137	123	55	125	1
35	0.47	B/3528-21	T495B474(1)035A(2)E1K5	0.5	4.0	1500	238	214	95	125	1
35	0.47	B/3528-21	T495B474(1)035A(2)E2K2	0.5	4.0	2200	197	177	79	125	1
35	0.47	B/3528-21	T495B474(1)035A(2)E2K5	0.5	4.0	2500	184	166	74	125	1
35	0.47	B/3528-21	T495B474(1)035A(2)E11K	0.5	4.0	11000	88	79	35	125	1
35	1	A/3216-18	T495A105(1)035A(2)E3K0	0.5	4.0	3000	158	142	63	125	1
35	1	B/3528-21	T495B105(1)035A(2)E1K5	0.5	4.0	1500	238	214	95	125	1
35	1	B/3528-21	T495B105(1)035A(2)E1K7	0.5	4.0	1700	224	202	90	125	1
35	1	B/3528-21	T495B105(1)035A(2)E2K0	0.5	4.0	2000	206	185	82	125	1
35	1	B/3528-21	T495B105(1)035A(2)E7K0	0.5	4.0	7000	110	99	44	125	1
35	2.2	B/3528-21	T495B225(1)035A(2)E1K5	0.8	6.0	1500	238	214	95	125	1
35	2.2	B/3528-21	T495B225(1)035A(2)E2K0	0.8	6.0	2000	206	185	82	125	1
35	2.2	B/3528-21	T495B225(1)035A(2)E4K0	0.8	6.0	4000	146	131	58	125	1
35	2.2	C/6032-28	T495C225(1)035A(2)E750	0.8	6.0	750	383	345	153	125	1
35	3.3	B/3528-21	T495B335(1)035A(2)E1K0	1.2	6.0	1000	292	263	117	125	1
35	3.3	B/3528-21	T495B335(1)035A(2)E900	1.2	6.0	900	307	276	123	125	1
35	3.3	C/6032-28	T495C335(1)035A(2)E525	1.2	6.0	525	458	412	183	125	1
35	3.3	C/6032-28	T495C335(1)035A(2)E550	1.2	6.0	550	447	402	179	125	1
35	3.3	C/6032-28	T495C335(1)035A(2)E600	1.2	6.0	600	428	385	171	125	1
35	4.7	B/3528-21	T495B475(1)035A(2)E850	1.6	6.0	850	316	284	126	125	1
35	4.7	B/3528-21	T495B475(1)035A(2)E1K0	1.6	6.0	1000	292	263	117	125	1
35	4.7	C/6032-28	T495C475(1)035A(2)E450	1.6	6.0	450	494	445	198	125	1
35	4.7	C/6032-28	T495C475(1)035A(2)E500	1.6	6.0	500	469	422	188	125	1
35	4.7	C/6032-28	T495C475(1)035A(2)E600	1.6	6.0	600	428	385	171	125	1
35	4.7	D/7343-31	T495D475(1)035A(2)E300	1.6	6.0	300	707	636	283	125	1
35	6.8	C/6032-28	T495C685(1)035A(2)E1K8	2.4	6.0	1800	247	222	99	125	1
35	6.8	D/7343-31	T495D685(1)035A(2)E150	2.4	6.0	150	1000	900	400	125	1
35	6.8	D/7343-31	T495D685(1)035A(2)E300	2.4	6.0	300	707	636	283	125	1
35	6.8	D/7343-31	T495D685(1)035A(2)E400	2.4	6.0	400	612	551	245	125	1
35	6.8	V/7343-20	T495V685(1)035A(2)E600	2.4	6.0	600	456	410	182	125	1
35	6.8	X/7343-43	T495X685(1)035A(2)E300	2.4	4.0	300	742	668	297	125	1
35	10	C/6032-28	T495C106(1)035A(2)E400	3.5	6.0	400	524	472	210	125	1
VDC at 85°C	µF	KEMET/EIA	(See below for part options)	µA +20°C Max/5 Min	% at +20°C 120 Hz Max	mΩ at 20°C 100 kHz Max	mA at +25°C 100 kHz	mA at +85°C 100 kHz	mA at +125°C 100 kHz	°C	Reflow Temp ≤ 260°C
Rated Voltage	Rated Cap	Case Code/ Case Size	KEMET Part Number	DC Leakage	DF	ESR	Maximum Allowable Ripple Current			Maximum Operating Temp	MSL

(1) To complete KEMET part number, insert M for ±20% or K for ±10%. Designates capacitance tolerance.

(2) To complete KEMET part number, insert T = 100% Matte Tin (Sn) Plated, G = Gold Plated, H = Standard Solder coated (SnPb 5% Pb minimum), N = Non-Magnetic 100% Tin (Sn) or M = Non-Magnetic (SnPb). Designates termination finish.

Refer to Ordering Information for additional detail.

Higher voltage ratings and tighter tolerance product including ESR may be substituted within the same size at KEMET's option. Voltage substitution will be marked with the higher voltage rating. Substitutions can include better than series.

Table 1 – Ratings & Part Number Reference cont'd

Rated Voltage	Rated Cap	Case Code/ Case Size	KEMET Part Number	DC Leakage	DF	ESR	Maximum Allowable Ripple Current			Maximum Operating Temp	MSL
							mA at +25°C 100 kHz	mA at +85°C 100 kHz	mA at +125°C 100 kHz		
VDC at 85°C	µF	KEMET/EIA	(See below for part options)	µA +20°C Max/5 Min	% at +20°C 120 Hz Max	mΩ at 20°C 100 kHz Max	mA at +25°C 100 kHz	mA at +85°C 100 kHz	mA at +125°C 100 kHz	°C	Reflow Temp ≤ 260°C
35	10	D/7343-31	T495D106(1)035A(2)E120	3.5	4.0	120	1118	1006	447	125	1
35	10	D/7343-31	T495D106(1)035A(2)E125	3.5	6.0	125	1095	986	438	125	1
35	10	D/7343-31	T495D106(1)035A(2)E130	3.5	6.0	130	1074	967	430	125	1
35	10	D/7343-31	T495D106(1)035A(2)E250	3.5	6.0	250	775	698	310	125	1
35	10	D/7343-31	T495D106(1)035A(2)E260	3.5	6.0	260	760	684	304	125	1
35	10	D/7343-31	T495D106(1)035A(2)E300	3.5	6.0	300	707	636	283	125	1
35	10	D/7343-31	T495D106(1)035A(2)E1K0	3.5	6.0	1000	387	348	155	125	1
35	10	V/7343-20	T495V106(1)035A(2)E600	3.5	6.0	600	456	410	182	125	1
35	10	X/7343-43	T495X106(1)035A(2)E175	3.5	6.0	175	971	874	388	125	1
35	10	X/7343-43	T495X106(1)035A(2)E200	3.5	6.0	200	908	817	363	125	1
35	10	X/7343-43	T495X106(1)035A(2)E250	3.5	4.0	250	812	731	325	125	1
35	10	X/7343-43	T495X106(1)035A(2)E260	3.5	4.0	260	797	717	319	125	1
35	15	C/6032-28	T495C156(1)035A(2)E350	5.3	6.0	350	561	505	224	125	1
35	15	D/7343-31	T495D156(1)035A(2)E225	5.3	6.0	225	816	734	326	125	1
35	15	D/7343-31	T495D156(1)035A(2)E260	5.3	6.0	260	760	684	304	125	1
35	15	D/7343-31	T495D156(1)035A(2)E300	5.3	6.0	300	707	636	283	125	1
35	15	X/7343-43	T495X156(1)035A(2)E200	5.3	6.0	200	908	817	363	125	1
35	15	X/7343-43	T495X156(1)035A(2)E225	5.3	6.0	225	856	770	342	125	1
35	15	X/7343-43	T495X156(1)035A(2)E250	5.3	6.0	250	812	731	325	125	1
35	15	X/7343-43	T495X156(1)035A(2)E260	5.3	6.0	260	797	717	319	125	1
35	22	D/7343-31	T495D226(1)035A(2)E125	7.7	6.0	125	1095	986	438	125	1
35	22	D/7343-31	T495D226(1)035A(2)E200	7.7	6.0	200	866	779	346	125	1
35	22	D/7343-31	T495D226(1)035A(2)E250	7.7	6.0	250	775	698	310	125	1
35	22	D/7343-31	T495D226(1)035A(2)E260	7.7	6.0	260	760	684	304	125	1
35	22	D/7343-31	T495D226(1)035A(2)E300	7.7	6.0	300	707	636	283	125	1
35	22	X/7343-43	T495X226(1)035A(2)E125	7.7	6.0	125	1149	1034	460	125	1
35	22	X/7343-43	T495X226(1)035A(2)E130	7.7	6.0	130	1127	1014	451	125	1
35	22	X/7343-43	T495X226(1)035A(2)E180	7.7	6.0	180	957	861	383	125	1
35	22	X/7343-43	T495X226(1)035A(2)E200	7.7	6.0	200	908	817	363	125	1
35	22	X/7343-43	T495X226(1)035A(2)E260	7.7	6.0	260	797	717	319	125	1
35	22	X/7343-43	T495X226(1)035A(2)E275	7.7	6.0	275	775	698	310	125	1
35	22	X/7343-43	T495X226(1)035A(2)E300	7.7	6.0	300	742	668	297	125	1
35	33	D/7343-31	T495D336(1)035A(2)E200	11.6	6.0	200	866	779	346	125	1
35	33	D/7343-31	T495D336(1)035A(2)E300	11.6	6.0	300	707	636	283	125	1
35	33	X/7343-43	T495X336(1)035A(2)E100	11.6	6.0	100	1285	1157	514	125	1
35	33	X/7343-43	T495X336(1)035A(2)E175	11.6	6.0	175	971	874	388	125	1
35	33	X/7343-43	T495X336(1)035A(2)E250	11.6	6.0	250	812	731	325	125	1
35	33	X/7343-43	T495X336(1)035A(2)E260	11.6	6.0	260	797	717	319	125	1
35	33	E/7360-38	T495E336(1)035A(2)E200	11.6	6.0	200	1000	900	400	125	1
35	47	X/7343-43	T495X476(1)035A(2)E185	16.5	8.0	185	944	850	378	125	1
35	47	X/7343-43	T495X476(1)035A(2)E200	16.5	8.0	200	908	817	363	125	1
35	47	X/7343-43	T495X476(1)035A(2)E230	16.5	8.0	230	847	762	339	125	1
35	47	X/7343-43	T495X476(1)035A(2)E300	16.5	8.0	300	742	668	297	125	1
50	1	C/6032-28	T495C105(1)050A(2)E1K3	0.5	4.0	1300	291	262	116	125	1
50	1	C/6032-28	T495C105(1)050A(2)E1K6	0.5	4.0	1600	262	236	105	125	1
VDC at 85°C	µF	KEMET/EIA	(See below for part options)	µA +20°C Max/5 Min	% at +20°C 120 Hz Max	mΩ at 20°C 100 kHz Max	mA at +25°C 100 kHz	mA at +85°C 100 kHz	mA at +125°C 100 kHz	°C	Reflow Temp ≤ 260°C
Rated Voltage	Rated Cap	Case Code/ Case Size	KEMET Part Number	DC Leakage	DF	ESR	Maximum Allowable Ripple Current			Maximum Operating Temp	MSL

(1) To complete KEMET part number, insert M for ±20% or K for ±10%. Designates capacitance tolerance.

(2) To complete KEMET part number, insert T = 100% Matte Tin (Sn) Plated, G = Gold Plated, H = Standard Solder coated (SnPb 5% Pb minimum), N = Non-Magnetic 100% Tin (Sn) or M = Non-Magnetic (SnPb). Designates termination finish.

Refer to Ordering Information for additional detail.

Higher voltage ratings and tighter tolerance product including ESR may be substituted within the same size at KEMET's option. Voltage substitution will be marked with the higher voltage rating. Substitutions can include better than series.

Table 1 – Ratings & Part Number Reference cont'd

Rated Voltage	Rated Cap	Case Code/ Case Size	KEMET Part Number	DC Leakage	DF	ESR	Maximum Allowable Ripple Current			Maximum Operating Temp	MSL
							mA at +25°C 100 kHz	mA at +85°C 100 kHz	mA at +125°C 100 kHz		
VDC at 85°C	µF	KEMET/EIA	(See below for part options)	µA +20°C Max/5 Min	% at +20°C 120 Hz Max	mΩ at 20°C 100 kHz Max	mA at +25°C 100 kHz	mA at +85°C 100 kHz	mA at +125°C 100 kHz	°C	Reflow Temp ≤ 260°C
50	2.2	D/7343-31	T495D225(1)050A(2)E600	1.1	6.0	600	500	450	200	125	1
50	3.3	D/7343-31	T495D335(1)050A(2)E700	1.7	6.0	700	463	417	185	125	1
50	4.7	D/7343-31	T495D475(1)050A(2)E275	2.4	6.0	275	739	665	296	125	1
50	4.7	D/7343-31	T495D475(1)050A(2)E300	2.4	6.0	300	707	636	283	125	1
50	4.7	X/7343-43	T495X475(1)050A(2)E300	2.4	4.0	300	742	668	297	125	1
50	6.8	D/7343-31	T495D685(1)050A(2)E190	3.4	6.0	190	889	800	356	125	1
50	6.8	D/7343-31	T495D685(1)050A(2)E200	3.4	6.0	200	866	779	346	125	1
50	6.8	D/7343-31	T495D685(1)050A(2)E275	3.4	6.0	275	739	665	296	125	1
50	6.8	D/7343-31	T495D685(1)050A(2)E300	3.4	6.0	300	707	636	283	125	1
50	6.8	D/7343-31	T495D685(1)050A(2)E400	3.4	6.0	400	612	551	245	125	1
50	6.8	X/7343-43	T495X685(1)050A(2)E300	3.4	6.0	300	742	668	297	125	1
50	10	X/7343-43	T495X106(1)050A(2)E250	5.0	8.0	250	812	731	325	125	1
50	10	X/7343-43	T495X106(1)050A(2)E260	5.0	6.0	260	797	717	319	125	1
50	10	X/7343-43	T495X106(1)050A(2)E300	5.0	6.0	300	742	668	297	125	1
50	15	X/7343-43	T495X156(1)050A(2)E200	7.5	6.0	200	908	817	363	125	1
50	15	X/7343-43	T495X156(1)050A(2)E250	7.5	6.0	250	812	731	325	125	1
50	15	X/7343-43	T495X156(1)050A(2)E300	7.5	6.0	300	742	668	297	125	1
VDC at 85°C	µF	KEMET/EIA	(See below for part options)	µA +20°C Max/5 Min	% at +20°C 120 Hz Max	mΩ at 20°C 100 kHz Max	mA at +25°C 100 kHz	mA at +85°C 100 kHz	mA at +125°C 100 kHz	°C	Reflow Temp ≤ 260°C
Rated Voltage	Rated Cap	Case Code/ Case Size	KEMET Part Number	DC Leakage	DF	ESR	Maximum Allowable Ripple Current			Maximum Operating Temp	MSL

(1) To complete KEMET part number, insert M for ±20% or K for ±10%. Designates capacitance tolerance.

(2) To complete KEMET part number, insert T = 100% Matte Tin (Sn) Plated, G = Gold Plated, H = Standard Solder coated (SnPb 5% Pb minimum), N = Non-Magnetic 100% Tin (Sn) or M = Non-Magnetic (SnPb). Designates termination finish.

Refer to Ordering Information for additional detail.

Higher voltage ratings and tighter tolerance product including ESR may be substituted within the same size at KEMET's option. Voltage substitution will be marked with the higher voltage rating. Substitutions can include better than series.

Recommended Voltage Derating Guidelines

	-55°C to 85°C	85°C to 125°C
% Change in Working DC Voltage with Temperature	V _R	67% of V _R
Recommended Maximum Application Voltage	50% of V _R	33% of V _R

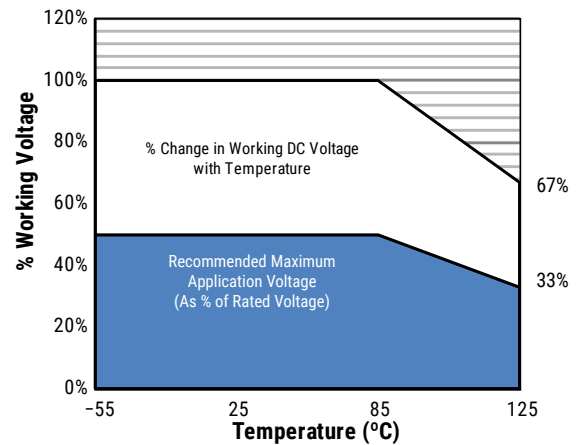

Ripple Current/Ripple Voltage

Permissible AC ripple voltage and current are related to equivalent series resistance (ESR) and the power dissipation capabilities of the device. Permissible AC ripple voltage which may be applied is limited by two criteria:

1. The positive peak AC voltage plus the DC bias voltage, if any, must not exceed the DC voltage rating of the capacitor.
2. The negative peak AC voltage in combination with bias voltage, if any, must not exceed the allowable limits specified for reverse voltage. See the Reverse Voltage section for allowable limits.

The maximum power dissipation by case size can be determined using the table at right. The maximum power dissipation rating stated in the table must be reduced with increasing environmental operating temperatures. Refer to the table below for temperature compensation requirements.

KEMET Case Code	EIA Case Code	Maximum Power Dissipation (P max) mWatts at 25°C w/+20°C Rise
A	3216-18	75
B	3528-21	85
C	6032-28	110
D	7343-31	150
X	7343-43	165
E	7360-38	200
S	3216-12	60
T	3528-12	70
U	6032-15	90
V	7343-20	125
T510X	7343-43	270
T510E	7360-38	285

Temperature Compensation Multipliers for Maximum Ripple Current		
T ≤ 25°C	T ≤ 85°C	T ≤ 125°C
1.00	0.90	0.40

T = Environmental Temperature

The maximum power dissipation rating must be reduced with increasing environmental operating temperatures. Refer to the Temperature Compensation Multiplier table for details.

Using the P max of the device, the maximum allowable rms ripple current or voltage may be determined.

$$I(max) = \sqrt{P_{max}/R}$$

$$E(max) = Z \sqrt{P_{max}/R}$$

I = rms ripple current (amperes)

E = rms ripple voltage (volts)

P max = maximum power dissipation (watts)

R = ESR at specified frequency (ohms)

Z = Impedance at specified frequency (ohms)

Reverse Voltage

Solid tantalum capacitors are polar devices and may be permanently damaged or destroyed if connected with the wrong polarity. The positive terminal is identified on the capacitor body by a stripe plus in some cases a beveled edge. A small degree of transient reverse voltage is permissible for short periods per the table. The capacitors should not be operated continuously in reverse mode, even within these limits.

Temperature	Permissible Transient Reverse Voltage
25°C	15% of Rated Voltage
85°C	5% of Rated Voltage
125°C	1% of Rated Voltage

Table 2 – Land Dimensions/Courtyard

KEMET	Metric Size Code	Density Level A: Maximum (Most) Land Protrusion (mm)					Density Level B: Median (Nominal) Land Protrusion (mm)					Density Level C: Minimum (Least) Land Protrusion (mm)						
		Case	EIA	W	L	S	V1	V2	W	L	S	V1	V2	W	L	S	V1	V2
A	3216-18	1.35	2.20	0.62	6.02	2.80	1.23	1.80	0.82	4.92	2.30	1.13	1.42	0.98	4.06	2.04		
B	3528-21	2.35	2.21	0.92	6.32	4.00	2.23	1.80	1.12	5.22	3.50	2.13	1.42	1.28	4.36	3.24		
M	3528-15	2.35	2.20	0.92	6.32	4.00	2.23	1.80	1.12	5.22	3.50	2.13	1.42	1.28	4.36	3.24		
C	6032-25	2.35	2.77	2.37	8.92	4.50	2.23	2.37	2.57	7.82	4.00	2.13	1.99	2.73	6.96	3.74		
U	6032-15	2.35	2.77	2.37	8.92	4.50	2.23	2.37	2.57	7.82	4.00	2.13	1.99	2.73	6.96	3.74		
D	7343-31	2.55	2.77	3.67	10.22	5.60	2.43	2.37	3.87	9.12	5.10	2.33	1.99	4.03	8.26	4.84		
E ¹	7360-38	4.25	2.77	3.67	10.22	7.30	4.13	2.37	3.87	9.12	6.80	4.03	1.99	4.03	8.26	6.54		
T	3528-12	2.35	2.20	0.92	6.32	4.00	2.23	1.80	1.12	5.22	3.50	2.13	1.42	1.28	4.36	3.24		
V	7343-20	2.55	2.77	3.67	10.22	5.60	2.43	2.37	3.87	9.12	5.10	2.33	1.99	4.03	8.26	4.84		
X ¹	7343-43	2.55	2.77	3.67	10.22	5.60	2.43	2.37	3.87	9.12	5.10	2.33	1.99	4.03	8.26	4.84		

Density Level A: For low-density product applications. Recommended for wave solder applications and provides a wider process window for reflow solder processes.

Density Level B: For products with a moderate level of component density. Provides a robust solder attachment condition for reflow solder processes.

Density Level C: For high component density product applications. Before adapting the minimum land pattern variations the user should perform qualification testing based on the conditions outlined in IPC standard 7351 (IPC-7351).

¹ Height of these chips may create problems in wave soldering.

² Land pattern geometry is too small for silkscreen outline.

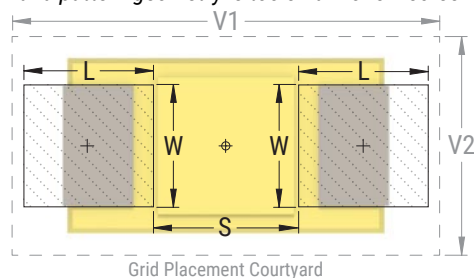

Soldering Process

KEMET’s families of surface mount capacitors are compatible with wave (single or dual), convection, IR, or vapor phase reflow techniques. Preheating of these components is recommended to avoid extreme thermal stress. KEMET’s recommended profile conditions for convection and IR reflow reflect the profile conditions of the IPC/J–STD–020D standard for moisture sensitivity testing. The devices can safely withstand a maximum of three reflow passes at these conditions.

Please note that although the X/7343–43 case size can withstand wave soldering, the tall profile (4.3 mm maximum) dictates care in wave process development.

Hand soldering should be performed with care due to the difficulty in process control. If performed, care should be taken to avoid contact of the soldering iron to the molded case. The iron should be used to heat the solder pad, applying solder between the pad and the termination, until reflow occurs. Once reflow occurs, the iron should be removed immediately. “Wiping” the edges of a chip and heating the top surface is not recommended.

During typical reflow operations, a slight darkening of the gold-colored epoxy may be observed. This slight darkening is normal and not harmful to the product. Marking permanency is not affected by this change.

Profile Feature	SnPb Assembly	Pb-Free Assembly
Preheat/Soak		
Temperature Minimum (T_{smin})	100°C	150°C
Temperature Maximum (T_{smax})	150°C	200°C
Time (t_s) from T_{smin} to T_{smax}	60 – 120 seconds	60 – 120 seconds
Ramp-up Rate (T_L to T_p)	3°C/seconds maximum	3°C/seconds maximum
Liquidous Temperature (T_L)	183°C	217°C
Time Above Liquidous (t_L)	60 – 150 seconds	60 – 150 seconds
Peak Temperature (T_p)	220°C* 235°C**	250°C* 260°C**
Time within 5°C of Maximum Peak Temperature (t_p)	20 seconds maximum	30 seconds maximum
Ramp-down Rate (T_p to T_L)	6°C/seconds maximum	6°C/seconds maximum
Time 25°C to Peak Temperature	6 minutes maximum	8 minutes maximum

Note: All temperatures refer to the center of the package, measured on the package body surface that is facing up during assembly reflow.

*Case Size D, E, P, Y, and X

**Case Size A, B, C, H, I, K, M, R, S, T, U, V, W, and Z

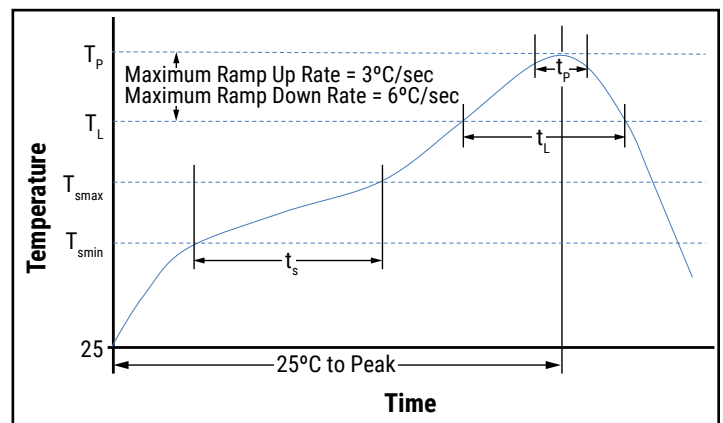

Storage

Tantalum chip capacitors should be stored in normal working environments. While the chips themselves are quite robust in other environments, solderability will be degraded by exposure to high temperatures, high humidity, corrosive atmospheres, and long term storage. In addition, packaging materials will be degraded by high temperature—reels may soften or warp and tape peel force may increase. KEMET recommends that maximum storage temperature not exceed 40°C and maximum storage humidity not exceed 60% relative humidity. Temperature fluctuations should be minimized to avoid condensation on the parts and atmospheres should be free of chlorine and sulphur bearing compounds. For optimized solderability chip stock should be used promptly, preferably within three years of receipt.

Construction

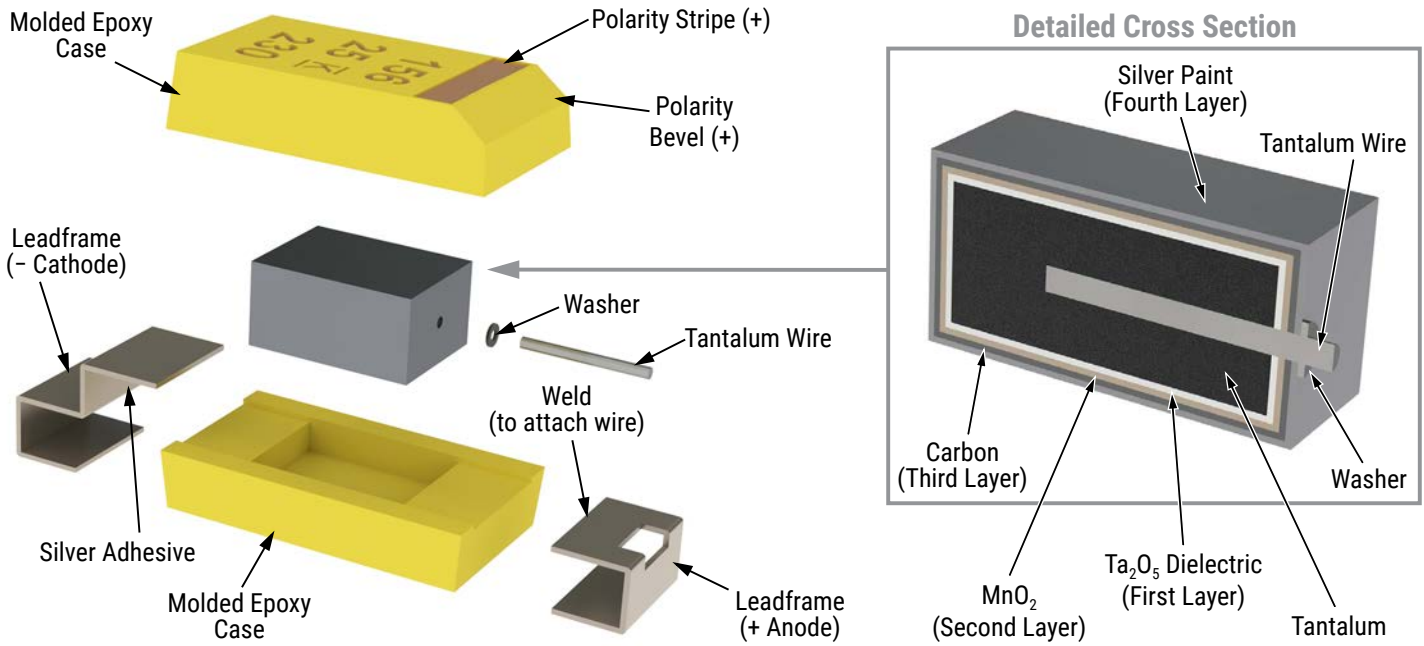

Capacitor Marking

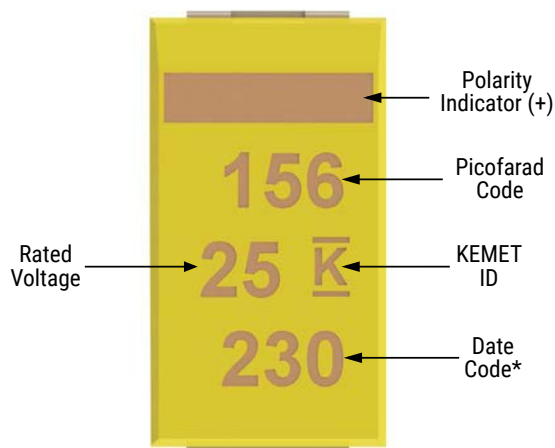

* 230 = 30th week of 2012

Date Code *	
1 st digit = Last number of Year	2 = 2012 3 = 2013 4 = 2014 5 = 2015 6 = 2016 7 = 2017
2 nd and 3 rd digit = Week of the Year	01 = 1 st week of the Year to 52 = 52 nd week of the Year

Tape & Reel Packaging Information

KEMET’s molded chip capacitor families are packaged in 8 and 12 mm plastic tape on 7" and 13" reels in accordance with *EIA Standard 481: Embossed Carrier Taping of Surface Mount Components for Automatic Handling*. This packaging system is compatible with all tape-fed automatic pick-and-place systems.

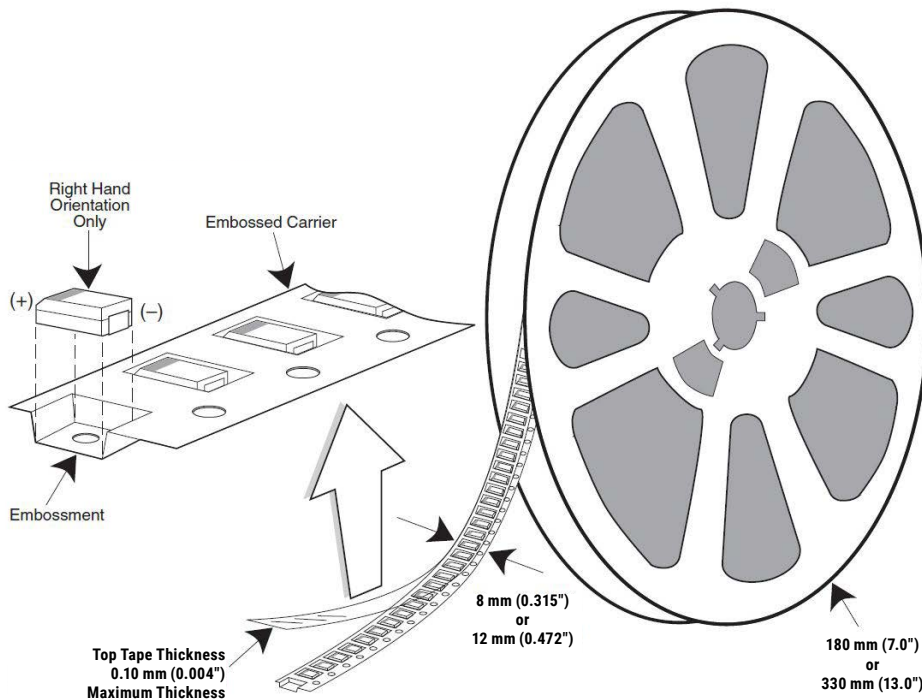

Table 3 – Packaging Quantity

Case Code		Tape Width (mm)	7" Reel*	13" Reel*
KEMET	EIA			
S	3216-12	8	2,500	10,000
T	3528-12	8	2,500	10,000
M	3528-15	8	2,000	8,000
U	6032-15	12	1,000	5,000
L	6032-19	12	1,000	3,000
W	7343-15	12	1,000	3,000
Z	7343-17	12	1,000	3,000
V	7343-20	12	1,000	3,000
A	3216-18	8	2,000	9,000
B	3528-21	8	2,000	8,000
C	6032-28	12	500	3,000
D	7343-31	12	500	2,500
Q	7343-12	12	1,000	3,000
Y	7343-40	12	500	2,000
X	7343-43	12	500	2,000
E/T428P	7360-38	12	500	2,000
H	7360-20	12	1,000	2,500

* No C-Spec required for 7" reel packaging. C-7280 required for 13" reel packaging.

Figure 1 – Embossed (Plastic) Carrier Tape Dimensions

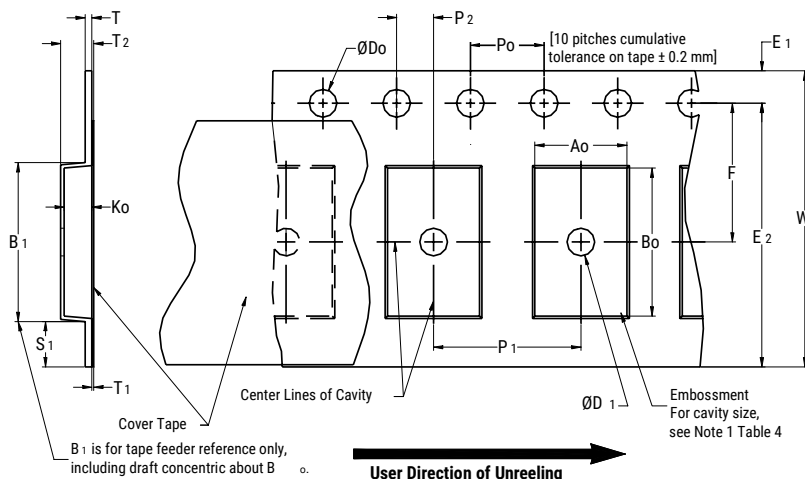

Table 4 – Embossed (Plastic) Carrier Tape Dimensions

Metric will govern

Constant Dimensions – Millimeters (Inches)									
Tape Size	D ₀	D ₁ Minimum Note 1	E ₁	P ₀	P ₂	R Reference Note 2	S ₁ Minimum Note 3	T Maximum	T ₁ Maximum
8 mm	1.5+0.10/-0.0 (0.059+0.004/-0.0)	1.0 (0.039)	1.75±0.10 (0.069±0.004)	4.0±0.10 (0.157±0.004)	2.0±0.05 (0.079±0.002)	25.0 (0.984)	0.600 (0.024)	0.600 (0.024)	0.100 (0.004)
12 mm		1.5 (0.059)							
16 mm						2.0±0.1 (0.079±0.059)			

Variable Dimensions – Millimeters (Inches)									
Tape Size	Pitch	B ₁ Maximum Note 4	E ₂ Minimum	F	P ₁	T ₂ Maximum	W Maximum	A ₀ , B ₀ & K ₀	
8 mm	Single (4 mm)	4.35 (0.171)	6.25 (0.246)	3.5±0.05 (0.138±0.002)	2.0±0.05 or 4.0±0.10 (0.079±0.002 or 0.157±0.004)	2.5 (0.098)	8.3 (0.327)	Note 5	
12 mm	Single (4 mm) & Double (8 mm)	8.2 (0.323)	10.25 (0.404)	5.5±0.05 (0.217±0.002)	2.0±0.05 (0.079±0.002) or 4.0±0.10 (0.157±0.004) or 8.0±0.10 (0.315 ±0.004)	4.6 (0.181)	12.3 (0.484)		
16 mm	Triple (12 mm)	12.1 (0.476)	14.25 (0.561)	7.5±0.10 (0.295±0.004)	4.0±0.10 (0.157±0.004) to 12.0±0.10 (0.472±0.004)	8.0 (0.315)	16.3 (0.642)		

1. The embossment hole location shall be measured from the sprocket hole controlling the location of the embossment. Dimensions of embossment location and hole location shall be applied independent of each other.
2. The tape, with or without components, shall pass around R without damage (see Figure 4).
3. If S₁ < 1.0 mm, there may not be enough area for cover tape to be properly applied (see EIA Standard 481–D, paragraph 4.3, section b).
4. B₁ dimension is a reference dimension for tape feeder clearance only.
5. The cavity defined by A₀, B₀ and K₀ shall surround the component with sufficient clearance that:
 - (a) the component does not protrude above the top surface of the carrier tape.
 - (b) the component can be removed from the cavity in a vertical direction without mechanical restriction, after the top cover tape has been removed.
 - (c) rotation of the component is limited to 20° maximum for 8 and 12 mm tapes and 10° maximum for 16 mm tapes (see Figure 2).
 - (d) lateral movement of the component is restricted to 0.5 mm maximum for 8 mm and 12 mm wide tape and to 1.0 mm maximum for 16 mm tape (see Figure 3).
 - (e) see Addendum in EIA Standard 481–D for standards relating to more precise taping requirements.

Packaging Information Performance Notes

- 1. Cover Tape Break Force:** 1.0 Kg minimum.
- 2. Cover Tape Peel Strength:** The total peel strength of the cover tape from the carrier tape shall be:

Tape Width	Peel Strength
8 mm	0.1 to 1.0 Newton (10 to 100 gf)
12 and 16 mm	0.1 to 1.3 Newton (10 to 130 gf)

The direction of the pull shall be opposite the direction of the carrier tape travel. The pull angle of the carrier tape shall be 165° to 180° from the plane of the carrier tape. During peeling, the carrier and/or cover tape shall be pulled at a velocity of 300 ±10 mm/minute.

- 3. Labeling:** Bar code labeling (standard or custom) shall be on the side of the reel opposite the sprocket holes. Refer to EIA Standards 556 and 624.

Figure 2 – Maximum Component Rotation



Figure 3 – Maximum Lateral Movement



Figure 4 – Bending Radius

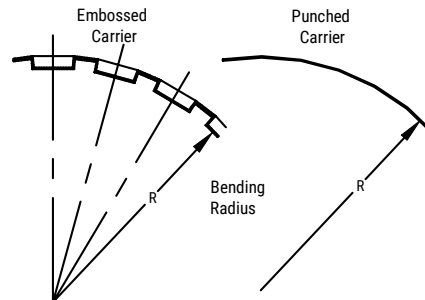

Figure 5 – Reel Dimensions



Note: Drive spokes optional; if used, dimensions B and D shall apply.

Table 5 – Reel Dimensions

Metric will govern

Constant Dimensions – Millimeters (Inches)				
Tape Size	A	B Minimum	C	D Minimum
8 mm	178±0.20 (7.008±0.008)	1.5 (0.059)	13.0+0.5/-0.2 (0.521+0.02/-0.008)	20.2 (0.795)
12 mm	or			
16 mm	330±0.20 (13.000±0.008)			
Variable Dimensions – Millimeters (Inches)				
Tape Size	N Minimum	W ₁	W ₂ Maximum	W ₃
8 mm	50 (1.969)	8.4+1.5/-0.0 (0.331+0.059/-0.0)	14.4 (0.567)	Shall accommodate tape width without interference
12 mm		12.4+2.0/-0.0 (0.488+0.078/-0.0)	18.4 (0.724)	
16 mm		16.4+2.0/-0.0 (0.646+0.078/-0.0)	22.4 (0.882)	

Figure 6 – Tape Leader & Trailer Dimensions

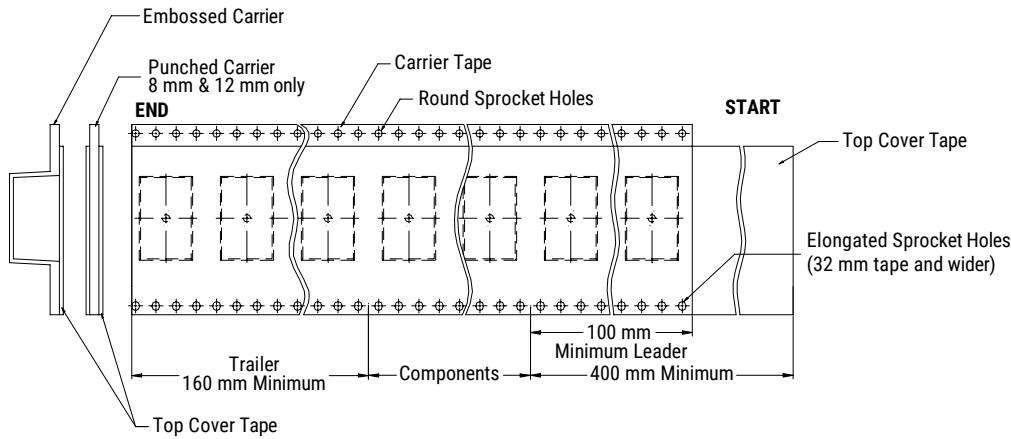
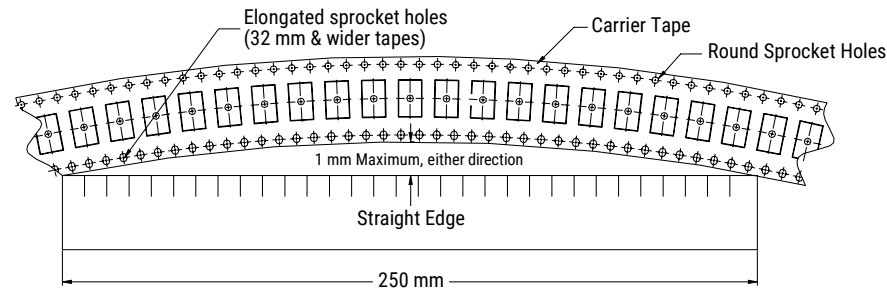

Figure 7 – Maximum Camber



KEMET Electronic Corporation Sales Offices

For a complete list of our global sales offices, please visit www.kemet.com/sales.

Disclaimer

All product specifications, statements, information and data (collectively, the "Information") in this datasheet are subject to change. The customer is responsible for checking and verifying the extent to which the Information contained in this publication is applicable to an order at the time the order is placed.

All Information given herein is believed to be accurate and reliable, but it is presented without guarantee, warranty, or responsibility of any kind, expressed or implied.

Statements of suitability for certain applications are based on KEMET Electronics Corporation's ("KEMET") knowledge of typical operating conditions for such applications, but are not intended to constitute – and KEMET specifically disclaims – any warranty concerning suitability for a specific customer application or use. The Information is intended for use only by customers who have the requisite experience and capability to determine the correct products for their application. Any technical advice inferred from this Information or otherwise provided by KEMET with reference to the use of KEMET's products is given gratis, and KEMET assumes no obligation or liability for the advice given or results obtained.

Although KEMET designs and manufactures its products to the most stringent quality and safety standards, given the current state of the art, isolated component failures may still occur. Accordingly, customer applications which require a high degree of reliability or safety should employ suitable designs or other safeguards (such as installation of protective circuitry or redundancies) in order to ensure that the failure of an electrical component does not result in a risk of personal injury or property damage.

Although all product-related warnings, cautions and notes must be observed, the customer should not assume that all safety measures are indicated or that other measures may not be required.