

Features

- Superior circuit protection
- Overcurrent and overvoltage protection
- Blocks surges up to rated limits
- High-speed performance
- Small SMT package
- RoHS compliant*
- Agency listing:

Applications

- Ethernet ports
- Protection modules and dongles
- Process control equipment
- Test and measurement equipment
- General electronics

TBU-DT Series - TBU® High-Speed Protectors

General Information

The TBU-DT Series of Bourns® TBU® (Transient Blocking Unit) products are very low capacitance dual unidirectional high-speed surge protection components designed to protect against faults caused by short circuits, AC power cross, induction and lightning surges.

The TBU-DT series is a unidirectional TBU® device; the TBU® protector will trip in less than 1 μ s when the current reaches the maximum value in one direction only, that is when Pin 1 is positive in voltage with respect to Pin 2, and Pin 4 is positive with respect to Pin 3. No current limiting exists in the opposite polarity, and the TBU® device appears as resistive in nature. The reverse current should not exceed the maximum trigger current level of the TBU® device. An external diode may be used to prevent reverse current in DC biased applications.

The TBU® protector blocks surges and provides an effective barrier behind which sensitive electronics will not be exposed to large voltages or currents during surge events. After the surge, the TBU® device resets when the voltage across the TBU® device falls to the V_{reset} level. The TBU® device will automatically reset on lines which have no DC bias or have DC bias below V_{reset} (such as unpowered signal lines).

The TBU® device is provided in a surface mount DFN package and meets industry standard requirements such as RoHS and Pb Free solder reflow profiles.

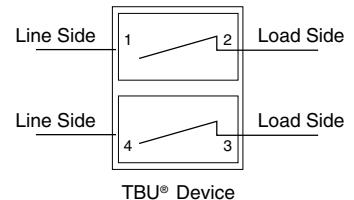

Agency Listing

Description	
UL	File Number: E315805

Absolute Maximum Ratings (@ $T_A = 25^\circ\text{C}$ Unless Otherwise Noted)

Symbol	Parameter	Part Number	Value	Unit
V_{imp}	Peak impulse voltage withstand with duration less than 10 ms	TBU-DT065-xxx-WH	650	V
		TBU-DT085-xxx-WH	850	
V_{rms}	Continuous A.C. RMS voltage	TBU-DT065-xxx-WH	300	V
		TBU-DT085-xxx-WH	425	
T_{op}	Operating temperature range		-40 to +125	$^\circ\text{C}$
T_{stg}	Storage temperature range		-65 to +150	$^\circ\text{C}$

Electrical Characteristics (@ $T_A = 25^\circ\text{C}$ Unless Otherwise Noted)

Symbol	Parameter	Part Number	Min.	Typ.	Max.	Unit
$I_{trigger}$	Current required for the device to go from operating state to protected state	TBU-DTxxx-100-WH	100	150	200	mA
		TBU-DTxxx-200-WH	200	300	400	
		TBU-DTxxx-300-WH	300	450	600	
		TBU-DTxxx-500-WH	500	750	1000	
R_{device}	Series resistance of the TBU® device	$V_{imp} = 650\text{ V}$ $I_{trigger}(\text{min.}) = 100\text{ mA}$	TBU-DT065-100-WH	8.5	10.0	Ω
		$V_{imp} = 650\text{ V}$ $I_{trigger}(\text{min.}) = 200\text{ mA}$	TBU-DT065-200-WH	5.6	6.6	
		$V_{imp} = 650\text{ V}$ $I_{trigger}(\text{min.}) = 300\text{ mA}$	TBU-DT065-300-WH	4.6	5.6	
		$V_{imp} = 650\text{ V}$ $I_{trigger}(\text{min.}) = 500\text{ mA}$	TBU-DT065-500-WH	4.0	4.8	
		$V_{imp} = 850\text{ V}$ $I_{trigger}(\text{min.}) = 100\text{ mA}$	TBU-DT085-100-WH	10.3	12.1	
		$V_{imp} = 850\text{ V}$ $I_{trigger}(\text{min.}) = 200\text{ mA}$	TBU-DT085-200-WH	7.4	8.7	
		$V_{imp} = 850\text{ V}$ $I_{trigger}(\text{min.}) = 300\text{ mA}$	TBU-DT085-300-WH	6.5	7.7	
		$V_{imp} = 850\text{ V}$ $I_{trigger}(\text{min.}) = 500\text{ mA}$	TBU-DT085-500-WH	5.8	6.9	
R_{match}	Package resistance matching of the TBU® device #1 - TBU® device #2		-0.5		+0.5	Ω
t_{block}	Time for the device to go from normal operating state to protected state				1	μs
I_Q	Current through the triggered TBU® device with 50 Vdc circuit voltage		0.25	0.50	1.00	mA
V_{reset}	Voltage below which the triggered TBU® device will transition to normal operating state		10	14	18	V
$R_{th(j-l)}$	Junction to package pads - FR4 using recommended pad layout			116		$^\circ\text{C/W}$
$R_{th(j-l)}$	Junction to package pads - FR4 using heat sink on board (6 cm ²)			96		$^\circ\text{C/W}$

*RoHS Directive 2002/95/EC Jan. 27, 2003 including annex and RoHS Recast 2011/65/EU June 8, 2011. Specifications are subject to change without notice.

The device characteristics and parameters in this data sheet can and do vary in different applications and actual device performance may vary over time. Users should verify actual device performance in their specific applications.

TBU-DT Series - TBU® High-Speed Protectors

BOURNS®

Reference Application

The TBU® device can be used to protect against excessive voltage surges in transformer coupled equipment, as shown in the figure below. The TBU® protector prevents any surges from causing damage. An overvoltage protection device, such as an MOV or GDT, may be used to provide additional overvoltage protection if the surge voltage is likely to be above the maximum rating of the TBU® device.

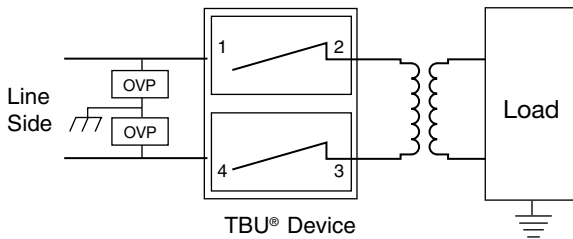

Basic TBU Operation

The TBU® device is a silicon-based, solid-state, resettable device which is placed in series with a signal path. The TBU® device operates in approximately 1 μ s - once line current exceeds the TBU® device's trigger current $I_{trigger}$. When operated, the TBU® device will limit the current to less than the $I_{trigger}$ value within the t_{block} duration. If voltage above V_{reset} is continuously sustained, the TBU® device will subsequently reduce the current to a quiescent current level within a period of time that is dependent upon the applied voltage.

After the surge, the TBU® device resets when the voltage across the TBU® device falls to the V_{reset} level. The TBU® device will automatically reset on lines which have no DC bias or have DC bias below V_{reset} (such as unpowered signal lines).

If the line has a normal DC bias above V_{reset} , the voltage across the TBU® device may not fall below V_{reset} after the surge. In such cases, special care needs to be taken to ensure that the TBU® device will reset, otherwise an automatic or manual power down will be required. Bourns application engineers can provide further assistance.

Performance Graphs

V-I Characteristic - TBU-DT085-300-WH (Pin 2-1 & Pin 3-4)

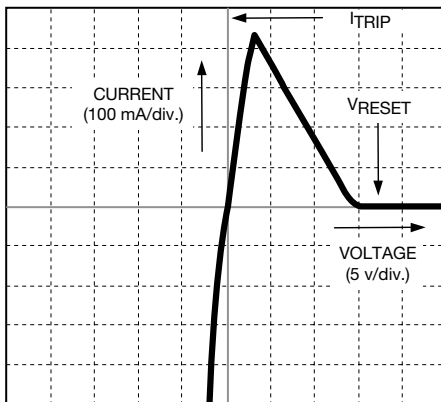

Typical Trigger Current vs. Temperature

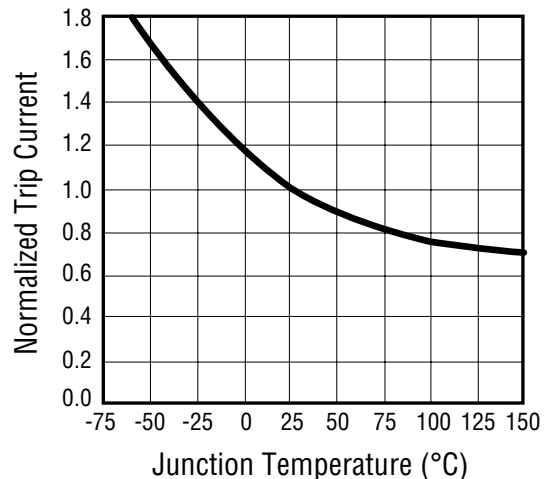

TBU-DT Series - TBU® High-Speed Protectors

BOURNS®

Performance Graphs (Continued)

Power Derating Curve

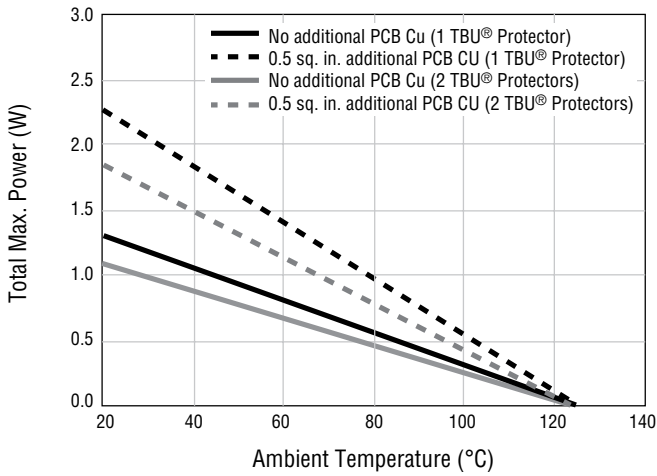

Typical Resistance vs. Temperature

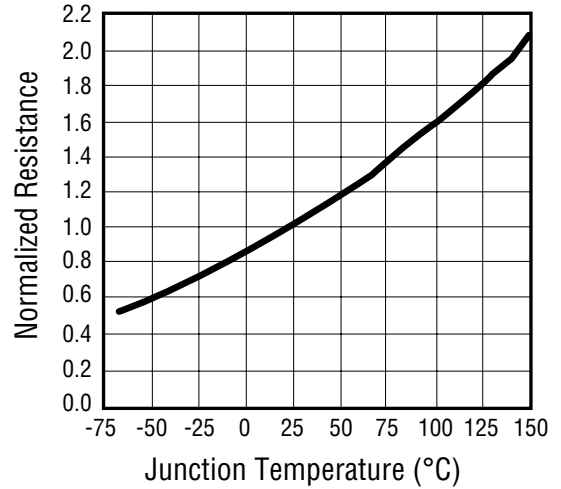

Reflow Profile

Profile Feature	Pb-Free Assembly
Average Ramp-Up Rate (T _{smax} to T _p)	3 °C/sec. max.
Preheat	
- Temperature Min. (T _{smin})	150 °C
- Temperature Max. (T _{smax})	200 °C
- Time (t _{smin} to t _{smax})	60-180 sec.
Time maintained above:	
- Temperature (T _L)	217 °C
- Time (t _L)	60-150 sec.
Peak/Classification Temperature (T _p)	260 °C
Time within 5 °C of Actual Peak Temp. (t _p)	20-40 sec.
Ramp-Down Rate	6 °C/sec. max.
Time 25 °C to Peak Temperature	8 min. max.

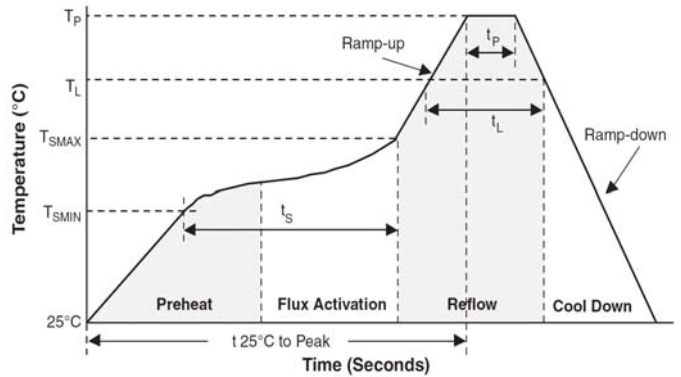

Specifications are subject to change without notice.

The device characteristics and parameters in this data sheet can and do vary in different applications and actual device performance may vary over time. Users should verify actual device performance in their specific applications.

TBU-DT Series - TBU® High-Speed Protectors

BOURNS®

Product Dimensions

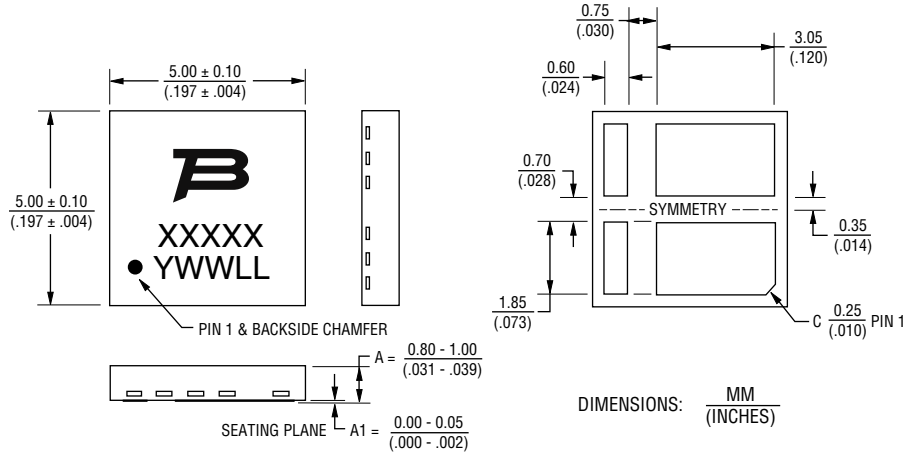

Recommended Pad Layout

TBU® High-Speed Protectors have a 100 % matte-tin termination finish. For improved thermal dissipation, the recommended layout uses PCB copper areas which extend beyond the exposed solder pad. The exposed solder pads should be defined by a solder mask which matches the pad layout of the TBU® device in size and spacing. It is recommended that they should be the same dimension as the TBU® pads but if smaller solder pads are used, they should be centered on the TBU® package terminal pads and not more than 0.10-0.12 mm (0.004-0.005 in.) smaller in overall width or length. Solder pad areas should not be larger than the TBU® pad sizes to ensure adequate clearance is maintained. The recommended

stencil thickness is 0.10-0.12 mm (0.004-0.005 in.) with a stencil opening size 0.025 mm (0.001 in.) less than the solder pad size. Extended copper areas beyond the solder pad significantly improve the junction to ambient thermal resistance, resulting in operation at lower junction temperatures with a corresponding benefit of reliability. All pads should be soldered to the PCB, including pads marked as NC or NU but no electrical connection should be made to these pads. For minimum parasitic capacitance, it is recommended that signal, ground or power signals are not routed beneath any pad.

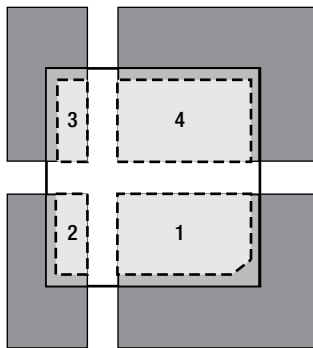

Dark grey areas show added PCB copper area for better thermal resistance.

Thermal Resistance vs. Additional PCB Cu Area

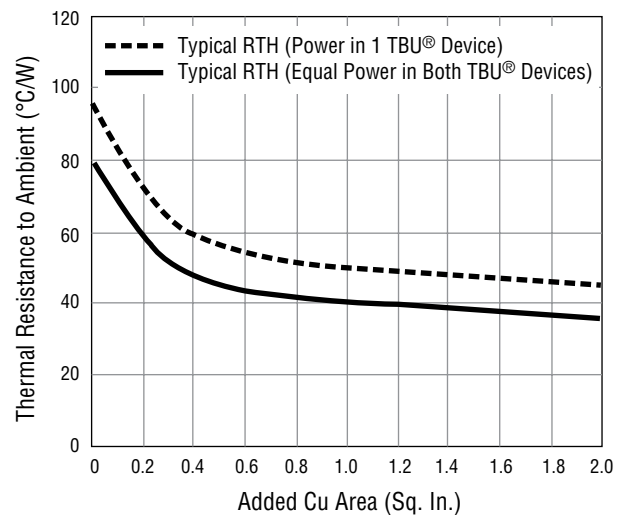

TBU-DT Series - TBU® High-Speed Protectors

BOURNS®

How to Order

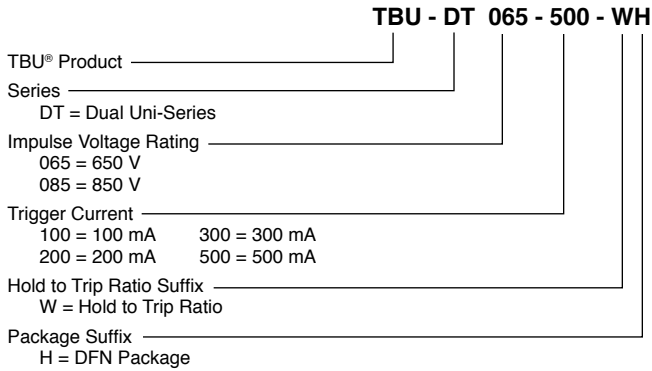

Typical Part Marking

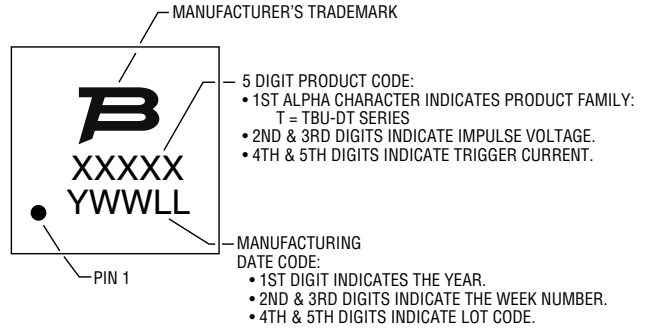

Packaging Specifications

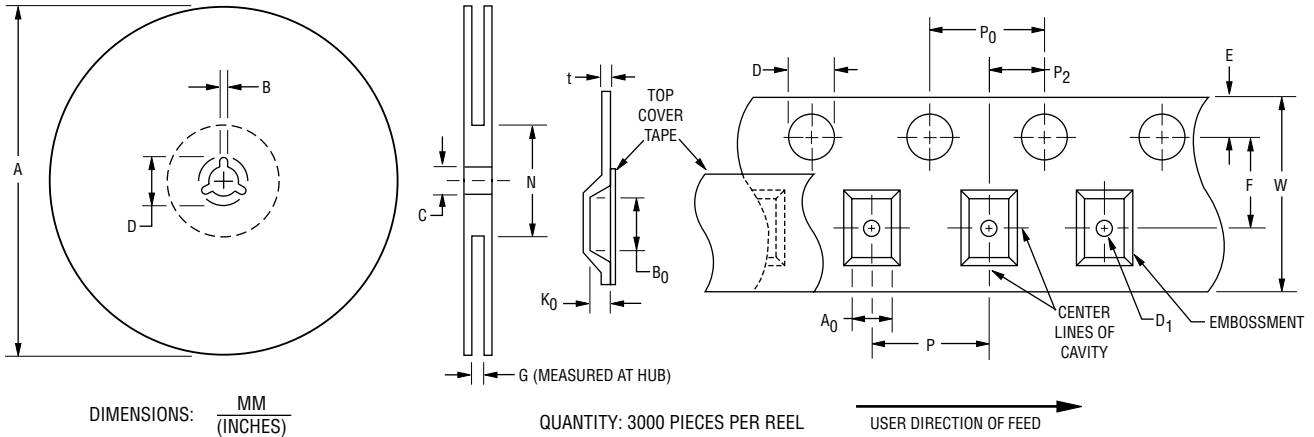

A		B		C		D		G	N
Min.	Max.	Min.	Max.	Min.	Max.	Min.	Max.	Ref.	Ref.
326	330	1.5	2.5	12.8	13.5	20.2	-	16.5	102
(12.835)	(13.002)	(.059)	(.098)	(.504)	(.531)	(.795)		(.650)	(4.016)

A0		B0		D		D1		E		F	
Min.	Max.	Min.	Max.	Min.	Max.	Min.	Max.	Min.	Max.	Min.	Max.
5.15	5.35	5.15	5.35	1.5	1.6	1.5	-	1.65	1.85	5.45	5.55
(.203)	(.211)	(.203)	(.211)	(.059)	(.063)	(.059)		(.065)	(.073)	(.214)	(.218)
K0		P		P0		P2		t		W	
Min.	Max.	Min.	Max.	Min.	Max.	Min.	Max.	Min.	Max.	Min.	Max.
1.0	1.2	7.9	8.1	3.8	4.2	1.95	2.05	0.25	0.35	11.7	12.3
(.039)	(.047)	(.311)	(.319)	(.150)	(.165)	(.077)	(.081)	(.010)	(.014)	(.461)	(.484)

REV. 01/17

"TBU" is a registered trademark of Bourns, Inc. in the United States and other countries. Specifications are subject to change without notice.

The device characteristics and parameters in this data sheet can and do vary in different applications and actual device performance may vary over time. Users should verify actual device performance in their specific applications.