



**WIDEBAND POWER AMPLIFIER
MODULE, 17 - 24 GHz**

Features

- Gain: 22 dB
- P1dB Output Power: +24 dBm
- Noise Figure: 3.5 dB
- Spurious-Free Operation
- Regulated Supply and Bias Sequencing
- Hermetically Sealed Module
- Field Replaceable 2.92mm connectors
- 55 °C to +85 °C Operating Temperature

Typical Applications

The HMC-C020 Wideband PA is ideal for:

- Microwave Radio & VSAT
- Military & Space
- Test & Lab Instrumentation

General Description

The HMC-C020 is a GaAs MMIC PHEMT Power Amplifier in a miniature, hermetic module with replaceable 2.92mm connectors which operates between 17 and 24 GHz. The amplifier provides 22 dB of gain, 3.5 dB noise figure, +33 dBm output IP3 and up to +24 dBm of output power at 1 dB gain compression. The wideband amplifier I/Os are internally matched to 50 Ohms and are DC blocked making the HMC-C020 ideal for EW, ECM RADAR and test equipment applications. Integrated voltage regulators allow for flexible biasing of both the negative and positive supply pins, while internal bias sequencing circuitry assures robust operation.

Functional Diagram

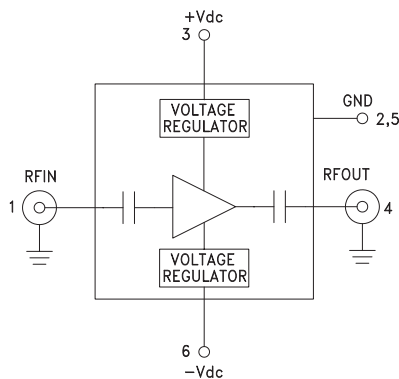

Electrical Specifications, $T_A = +25^\circ C$, +Vdc = +8V to +15V, -Vdc = -4V to -10V*

Parameter	Min.	Typ.	Max.	Min.	Typ.	Max.	Units
Frequency Range	17 - 20		20 - 24				GHz
Gain	19	22	24	19	22	24	dB
Gain Flatness		±1.0			±0.5		dB
Gain Variation Over Temperature		-0.03	-0.04		-0.03	-0.04	dB/ °C
Noise Figure		3.5	5.5		4.5	6.5	dB
Input Return Loss		7			7		dB
Output Return Loss		10			10		dB
Output Power for 1 dB Compression (P1dB)	20	23		20	24		dBm
Saturated Output Power (P _{sat})		25			26		dBm
Output Third Order Intercept (IP3)		33			33		dBm
Positive Supply Current (+IDC)		250			250		mA
Negative Supply Current (-IDC)		5.2			5.2		mA

* Data recorded at +Vdc = +12V and - Vdc = -5V

Information furnished by Analog Devices is believed to be accurate and reliable. However, no responsibility is assumed by Analog Devices for its use, nor for any infringements of patents or other rights of third parties that may result from its use. Specifications subject to change without notice. No license is granted by implication or otherwise under any patent or patent rights of Analog Devices. Trademarks and registered trademarks are the property of their respective owners.

For price, delivery, and to place orders: Analog Devices, Inc., One Technology Way, P.O. Box 9106, Norwood, MA 02062-9106 Phone: 781-329-4700 • Order online at www.analog.com Application Support: Phone: 1-800-ANALOG-D

HMC-C020* PRODUCT PAGE QUICK LINKS

Last Content Update: 02/23/2017

COMPARABLE PARTS

View a parametric search of comparable parts.

DOCUMENTATION

Application Notes

- AN-1363: Meeting Biasing Requirements of Externally Biased RF/Microwave Amplifiers with Active Bias Controllers

Data Sheet

- HMC-C020 Data Sheet

TOOLS AND SIMULATIONS

- HMC-C020 S-Parameter

DESIGN RESOURCES

- HMC-C020 Material Declaration
- PCN-PDN Information
- Quality And Reliability
- Symbols and Footprints

DISCUSSIONS

View all HMC-C020 EngineerZone Discussions.

SAMPLE AND BUY

Visit the product page to see pricing options.

TECHNICAL SUPPORT

Submit a technical question or find your regional support number.

DOCUMENT FEEDBACK

Submit feedback for this data sheet.



**WIDEBAND POWER AMPLIFIER
MODULE, 17 - 24 GHz**

Gain & Return Loss

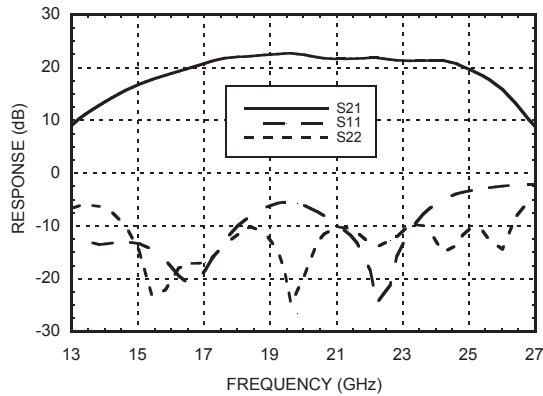

Gain vs. Temperature

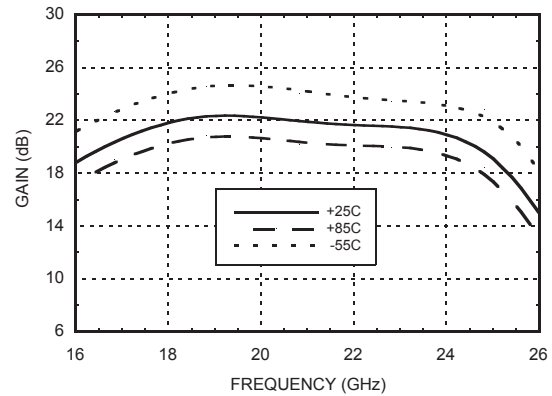

Input Return Loss vs. Temperature

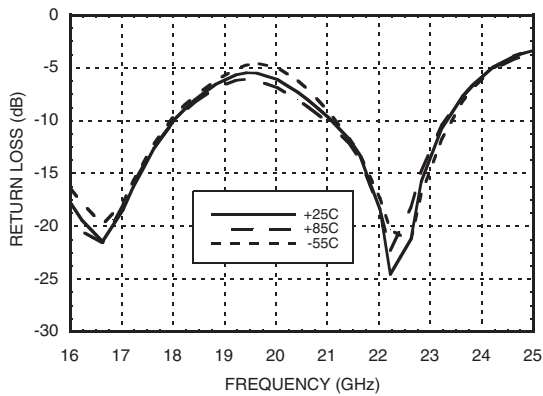

Output Return Loss vs. Temperature

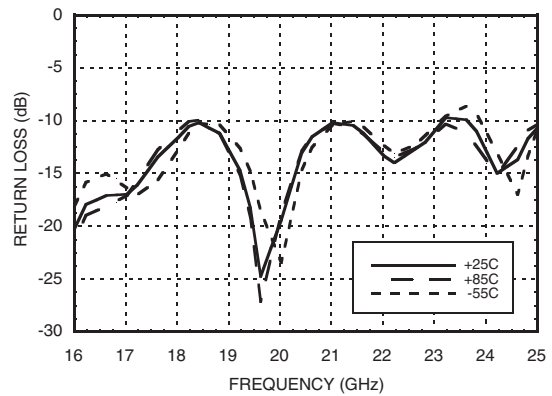

Reverse Isolation vs. Temperature

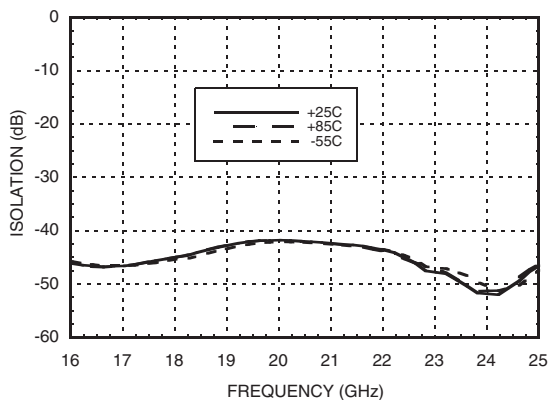

Noise Figure vs. Temperature

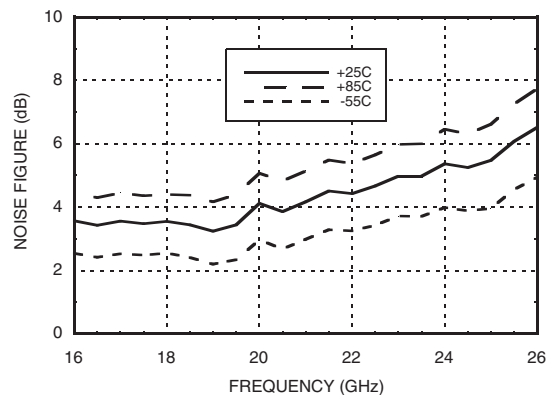

Information furnished by Analog Devices is believed to be accurate and reliable. However, no responsibility is assumed by Analog Devices for its use, nor for any infringements of patents or other rights of third parties that may result from its use. Specifications subject to change without notice. No license is granted by implication or otherwise under any patent or patent rights of Analog Devices. Trademarks and registered trademarks are the property of their respective owners.

For price, delivery, and to place orders: Analog Devices, Inc., One Technology Way, P.O. Box 9106, Norwood, MA 02062-9106 Phone: 781-329-4700 • Order online at www.analog.com Application Support: Phone: 1-800-ANALOG-D



**WIDEBAND POWER AMPLIFIER
MODULE, 17 - 24 GHz**

P1dB vs. Temperature

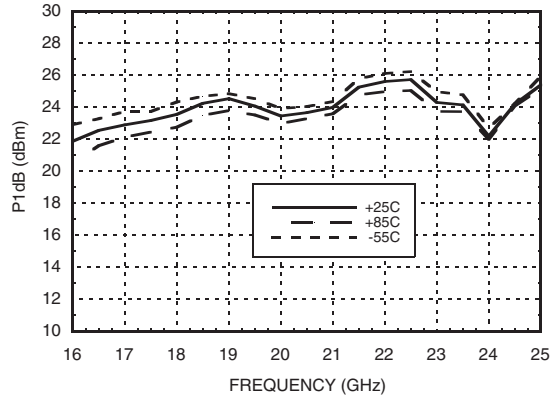

Psat vs. Temperature

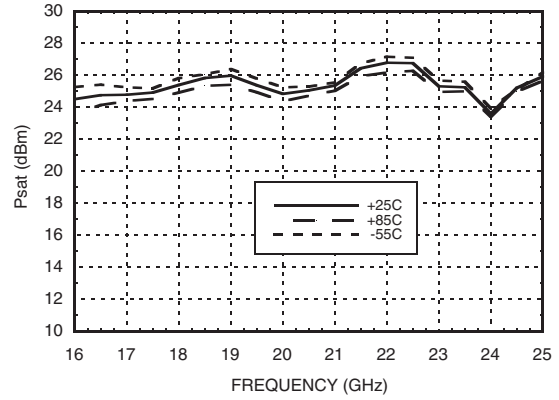

Output IP3 vs. Temperature

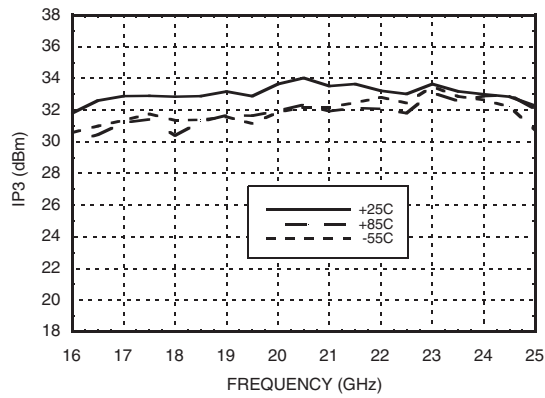

Absolute Maximum Ratings

Positive Bias Supply Voltage (+Vdc)	+17V Max
Negative Bias Supply (-Vdc)	-16V Min.
RF Input Power (RFIN)	+20 dBm
Storage Temperature	-65 to +150 °C
Operating Temperature	-55 to +85 °C





**ELECTROSTATIC SENSITIVE DEVICE
OBSERVE HANDLING PRECAUTIONS**

WIDEBAND POWER AMPLIFIER MODULE, 17 - 24 GHz

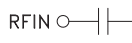

Pin Descriptions

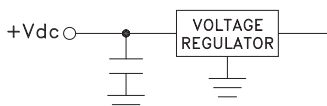
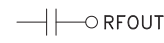
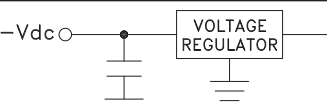
Pin Number	Function	Description	Interface Schematic
1	RFIN	RF input connector, 2.92mm female, field replaceable. This pin is AC coupled and matched to 50 Ohms.	
2, 5	GND	Power supply ground.	
3	+Vdc	Positive power supply voltage for the amplifier.	
4	RFOUT	RF output connector, 2.92mm female. This pin is AC coupled and matched to 50 Ohms.	
6	-Vdc	Negative power supply voltage for the amplifier	

**WIDEBAND POWER AMPLIFIER
MODULE, 17 - 24 GHz**



Outline Drawing

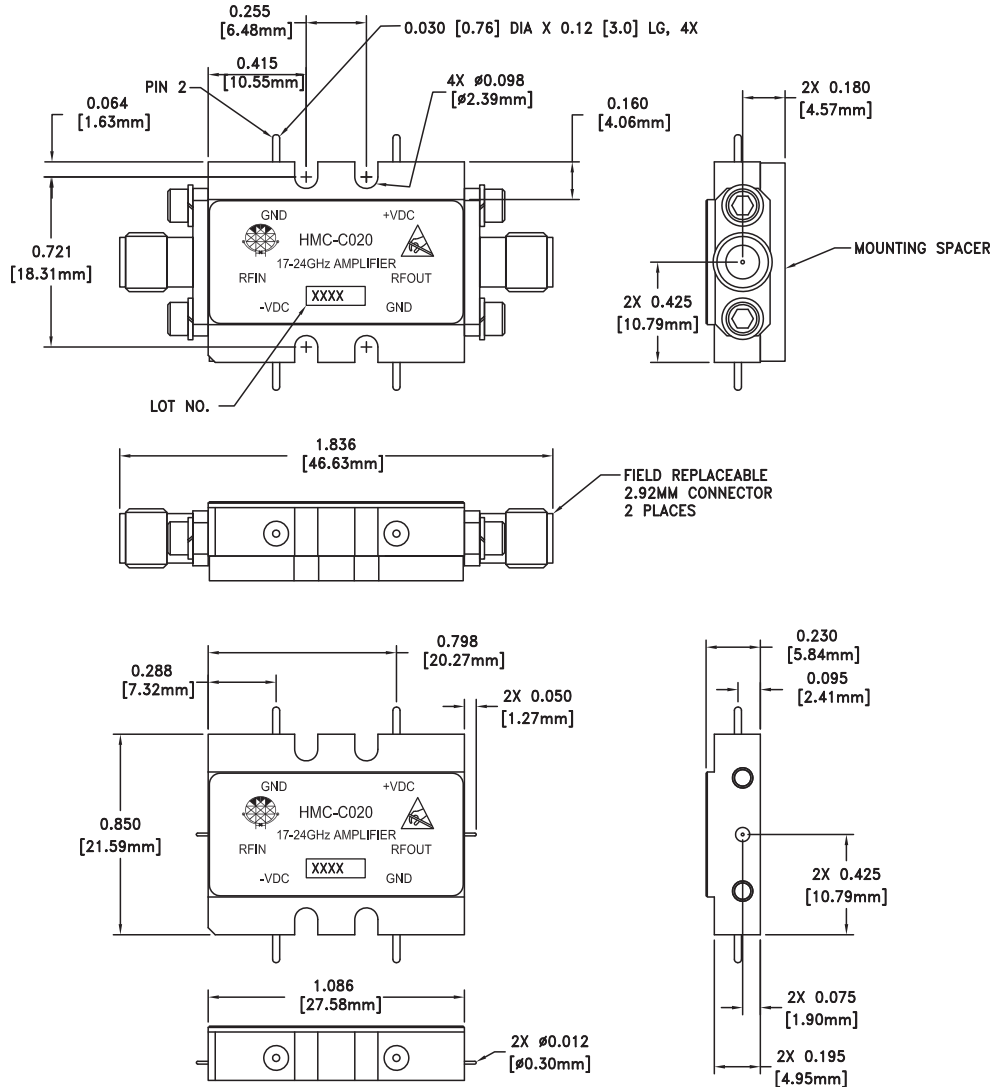

VIEW SHOWN WITH CONNECTORS REMOVED

Package Information

Package Type	C-10
Package Weight [1]	18.7 gms [2]
Spacer Weight	3.3 gms [2]

[1] Includes the connectors

[2] ±1 gms Tolerance

NOTES:

1. PACKAGE, LEADS, COVER MATERIAL: KOVAR™
2. FINISH: GOLD PLATE OVER NICKEL PLATE
3. ALL DIMENSIONS ARE IN INCHES [MILLIMETERS]
4. TOLERANCES:
 - 4.1 .XX = ±0.02
 - 4.2 .XXX = ±0.010
5. FIELD REPLACEABLE 2.92mm CONNECTORS TENSOLITE 231CCSF OR EQUIVALENT

**WIDEBAND POWER AMPLIFIER
MODULE, 17 - 24 GHz****Notes:**