

TPS61050EVM-269 and TPS61052EVM-269

This user's guide describes the characteristics, operation, and use of the TPS61050EVM-269 and TPS61052EVM-269 evaluation modules (EVMs). This EVM demonstrates either the Texas Instruments TPS61050 or TPS61052 synchronous boost converter based high power WLED driver with I²C interface. This document includes setup instructions, a schematic diagram, a bill of materials, and PCB layout drawings for the evaluation module.

Contents

1	Introduction	2
2	Setup	2
3	Software Setup and Operation	6
4	Test Results	7
5	Board Layout.....	10
6	Schematics and Bill of Materials	13

List of Figures

1	TPS6105x Software Main Panel.....	6
2	LED Efficiency vs. Input Voltage - Torch Mode.....	7
3	LED Efficiency vs. Input voltage - Single Pulse Flash Mode.....	8
4	Torch Flash Sequence	8
5	Start Up in Torch.....	9
6	Inrush Current at Flash	9
7	Voltage Mode Efficiency.....	10
8	Voltage Mode Load Transient	10
9	Assembly Layer.....	11
10	Top Layer.....	11
11	Layer 2.....	12
12	Layer 3	12
13	Bottom Layer.....	13
14	TPS61050/2EVM-269 Schematic	14

List of Tables

1	Jumper Settings.....	5
2	TPS61050EVM-269 and TPS61052EVM-269 (HPA269-001 and HPA269-002) Bill of Materials.....	15

Windows is a trademark of Microsoft Corporation.
I²C is a trademark of Philips Corporation.
VeriSign is a trademark of VeriSign, Inc..

1 Introduction

1.1 Requirements

To operate this EVM, connect and properly configure the following components:

A personal computer (PC) with a USB port is required to operate this EVM. The TPS61050/2 interface software runs on the PC and communicates with the EVM via the PC's USB port. Commands can be sent to the internal registers of the TPS61050/2 through the USB port.

Personal Computer Requirements

- Windows™ 2000 or Windows™ XP operating system
- USB port
- Minimum of 30 MB of free hard disk space (100 MB recommended)
- Minimum of 256 MB of RAM

Printed-Circuit Board Assembly

The board contains either the TPS61050 or TPS61052 IC in QFN package, its required external components and a high power WLED.

USB-TO-GPIO Adapter

The USB-TO-GPIO adapter is the link that allows the PC and the EVM to communicate. One end of the USB interface adapter connects to the PC with the supplied USB cable; the other end of the USB interface adapter connects to the EVM with the supplied ribbon cable.

When a command is written to the EVM, the interface program running on the PC sends the commands to the PC USB port. The USB interface adapter receives the USB command, converts the signal to an I²C protocol, and sends the I²C signal to the TPS61050/2 EVM board.

Software

Texas Instruments provides software to assist in evaluating this EVM. The software can be installed from the supplied CD or downloaded from the Texas Instruments Web site at www.ti.com.

2 Setup

This section describes the jumpers and connectors on the EVM as well as how to properly connect, set up, and use the TPS61050EVM-269 and TPS61052EVM-269.

2.1 Board Input/Output Connector Descriptions

2.1.1 J1 – FLASH / GND

This header connects to the IC's FLASH pin and GND. It can be used to measure the voltage on the FLASH pin and/or apply an external signal to the FLASH pin.

2.1.2 J2 – VIN

This header is for the positive input supply voltage to the converter. The leads to the input supply should be twisted and kept as short as possible to minimize EMI transmission and reduce inductive voltage droop at a load transient event.

2.1.3 J3 – GND

This is the return connection for the input power supply of the converter.

2.1.4 J4 –SCL/SDA

This header connects to the IC I²C SCL and SDA control and data lines. It can be used to monitor the data traffic between the USB-TO-GPIO and EVM.

2.1.5 J5 – I²C Input

This connector provides a connection for the included USB-TO-GPIO interface adapter. The included software uses the adapter to communicate with the EVM using the I²C protocol.

2.1.6 J6 – PULSE GEN / GND

This header can be used to connect an external pulse generator to drive the gate of transistor Q1. Transistor Q1, along with components R5 - R7, can be used to perform load transient testing and confirm stability.

2.1.7 J7 – TRANS RES

This header connects to transistor Q1 drain.

2.1.8 J8 – VOUT

This header connects to the IC VOUT pin. In voltage regulation mode, it can be used to measure the regulated output voltage and connect an external load resistance. In current regulation mode, it connects to the WLED's cathode and can be used to measure the high-side WLED voltage.

2.1.9 J9 – LED

This header connects to the IC's LED pin. In current regulation mode, it connects to the WLED anode and can be used to measure the low-side WLED voltage. It is not used in voltage regulation mode.

2.1.10 J10 – GND

This header connects to the board's ground plane and is the return for the VOUT header.

2.1.11 JP1 – I²C PULLUP

This jumper is used to connect the SCL and SDA 15-k Ω pull-up resistors to the board's input voltage. This jumper should remain in its default installed position if the USB-TO-GPIO adapter is used to provide the I²C interface. If jumper JP1 is uninstalled, then the low side of the jumper must be tied to the external source that is powering an alternate I²C interface, OR R2 and/or R3 must be removed and the SCL and SDA data lines must be pulled up through resistors to that same external source using header J4.

2.1.12 JP2 – GPIO INPUT or OUTPUT

The middle pin of this jumper connects to the GPIO pin on the TPS61050 and the ENVM pin on the TPS61052. If the TPS61050 GPIO pin is configured for input and this jumper is set to INPUT, then the GPIO pin is connected to JP4, which can be jumper connected to either VIN or GND. If the TPS61050 GPIO pin is configured for output and this jumper is set to OUTPUT, then the GPIO pin is connected to JP3. When shorted, JP3 connects a diode in series with the GPIO output pin. Since the TPS61052 ENVM pin is an input pin, JP2 should be left open to allow for connection to an external signal generator or shorted to INPUT. This jumper's default position is uninstalled.

2.1.13 JP3 – OUTPUT LED

When shorted, this jumper connects diode D1 in series with the OUTPUT side of JP2. With the TPS61050 GPIO configured for output, the diode turns on when the GPIO output is low. JP2 must be connected to OUTPUT for this jumper to be effective. This jumper's default position is uninstalled.

2.1.14 JP4 – INPUT: VIN or GND

The middle pin of this jumper connects the INPUT side of JP2. This jumper is intended to facilitate connection of either the TPS61050 GPIO, when configured as INPUT, or the TPS61052 ENV pin to VIN, for a logic high, or GND, for a logic low. JP2 must be connected to INPUT for this jumper to be effective. The jumper default position is uninstalled.

2.1.15 JP5 – OPEN LED

This jumper is in series with power WLED, D2. For the WLED to turn on, this jumper must be shorted. Placing an ammeter in series allows the user to measure current. This jumper's default position is installed.

2.1.16 S1 – FLASH

This push-button switch connects to the IC FLASH pin and allows the user to initiate a WLED flash event.

WARNING

This EVM has a white LED that flashes very brightly. Protective eye wear and/or a diffuser to cover the white LED is recommended.

2.2 Software Setup

If installing from a CD, insert the CD and run Setup.exe; follow all the prompts to install the software.

If installing from the TI Web site, go to the URL,
<http://focus.ti.com/en/download/aap/DesignEnv/TPS6105xEVM-SW/publish.htm>

Note: This installation page is best viewed with Microsoft Internet Explorer browser (It may not work correctly with other browsers)

Click on the install button; your PC should give you a security warning and ask if you want to install this application. Select Install to proceed. If version 22 or older is currently installed on your PC, you must uninstall this version of the software before installing version 23 or later from either the CD or website.

With both types of installation, the software attempts to install the Microsoft Dot Net Framework 2.0 (if it is not already installed) This framework is required for the software to run.

After installation, the software should automatically run. To run the software later, go to

Start->all programs-> Texas Instruments, Inc. -> TPS6105x EVM Software.

During future use of the software, it may prompt you to install a new version if one becomes available on the Web.

Note: VeriSign™ Code Signing is used to prevent any malicious code from changing this application. If at any time in the future the binaries are modified, the code will no longer attempt to run.

2.3 Hardware Setup

Table 1 shows the board DEFAULT jumper settings.

Table 1. Jumper Settings

JUMPER	DEFAULT
JP1	Installed
JP2	Uninstalled
JP3	Uninstalled
JP4	Uninstalled
JP5	Installed

Connect the USB-TO-GPIO adapter to your PC using the supplied USB cable. Connect the TPS61050/2EVM connector J5 to the USB-TO-GPIO adapter using the supplied 10-pin ribbon cable. The connectors on the ribbon cable are keyed to prevent incorrect installation.

USB Interface Adaptor Quick Connection Diagram

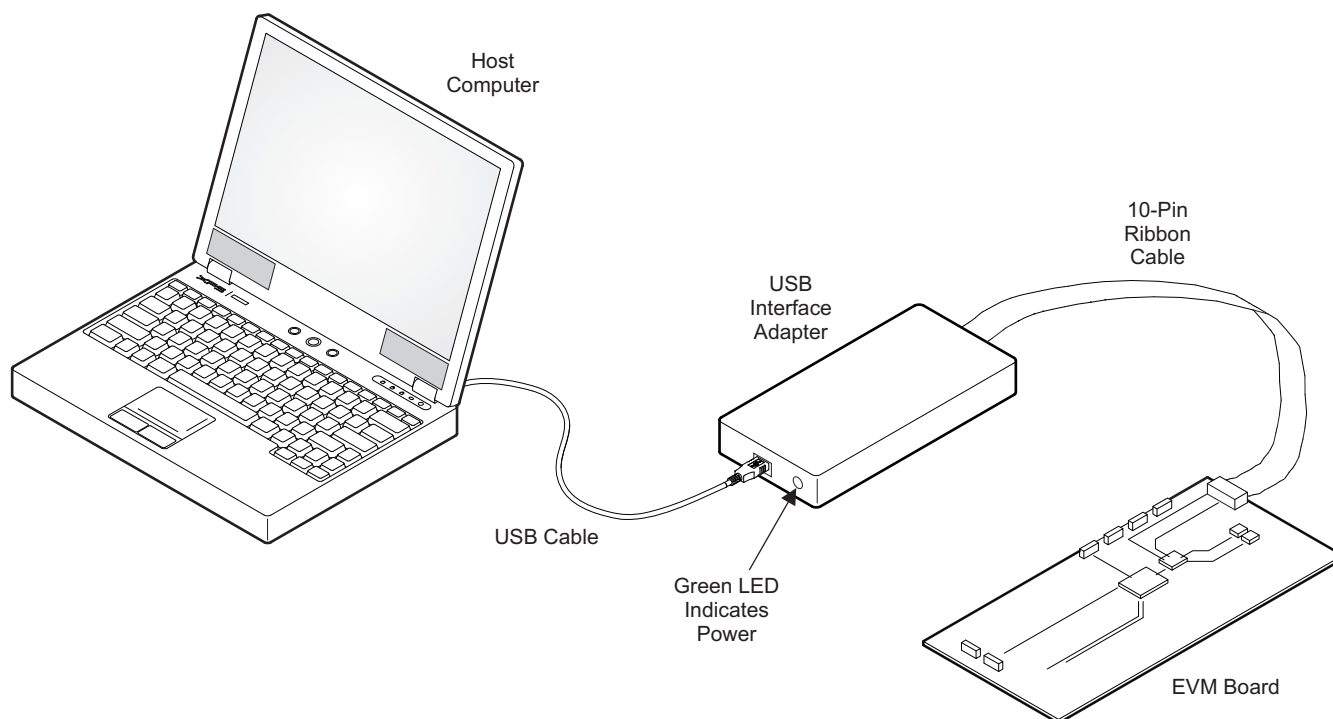

Connect at least a 2-A rated input power supply set to provide between 2.5 V and 6.0 V output to J2 and J3. The leads should be very short. Additional input capacitance may be required in order to mitigate the inductive voltage droop that occurs at torch current start up and especially when the flash pulse occurs (see figures 5 and 6). Turn on the power supply.

WARNING: This EVM has a white LED that flashes very brightly. Protective eye wear and/or a diffuser to cover the white LED during operation is recommended.

3 Software Setup and Operation

This section provides descriptions of the EVM software.

The supplied software is used to communicate with the TPS61050/2EVM. Click on the icon on the host PC to start the software. The host PC software first checks the firmware version of the USB-TO-GPIO adapter box. If an incorrect firmware version is installed, the software automatically searches on the Internet (if connected) for updates. If a new update is available, the software notifies the user of the update, downloads and installs the software. Note that after the firmware is updated, the user must disconnect and then reconnect the USB cable between the adapter and PC, as instructed during the install process. The host PC software also automatically searches on the Internet (if connected) for updates. If a new update is available, the software notifies the user of the update, downloads and installs the update.

The software then asks which version of the IC is on the board and the desired current limit. Check the appropriate box for the IC, then select the current limit to be either 1000 mA or 1500 mA due to the 1500 mA rated inductor on this EVM, and finally click the *continue* button. Although the PCB can be powered up after the software is initiated, in order for the user to be able to set the current limit to a value other than the default, the PCB must be powered on before the software is initiated.

The software displays the main control panel for the user interface. Figure 1 shows the user interface main control panel.

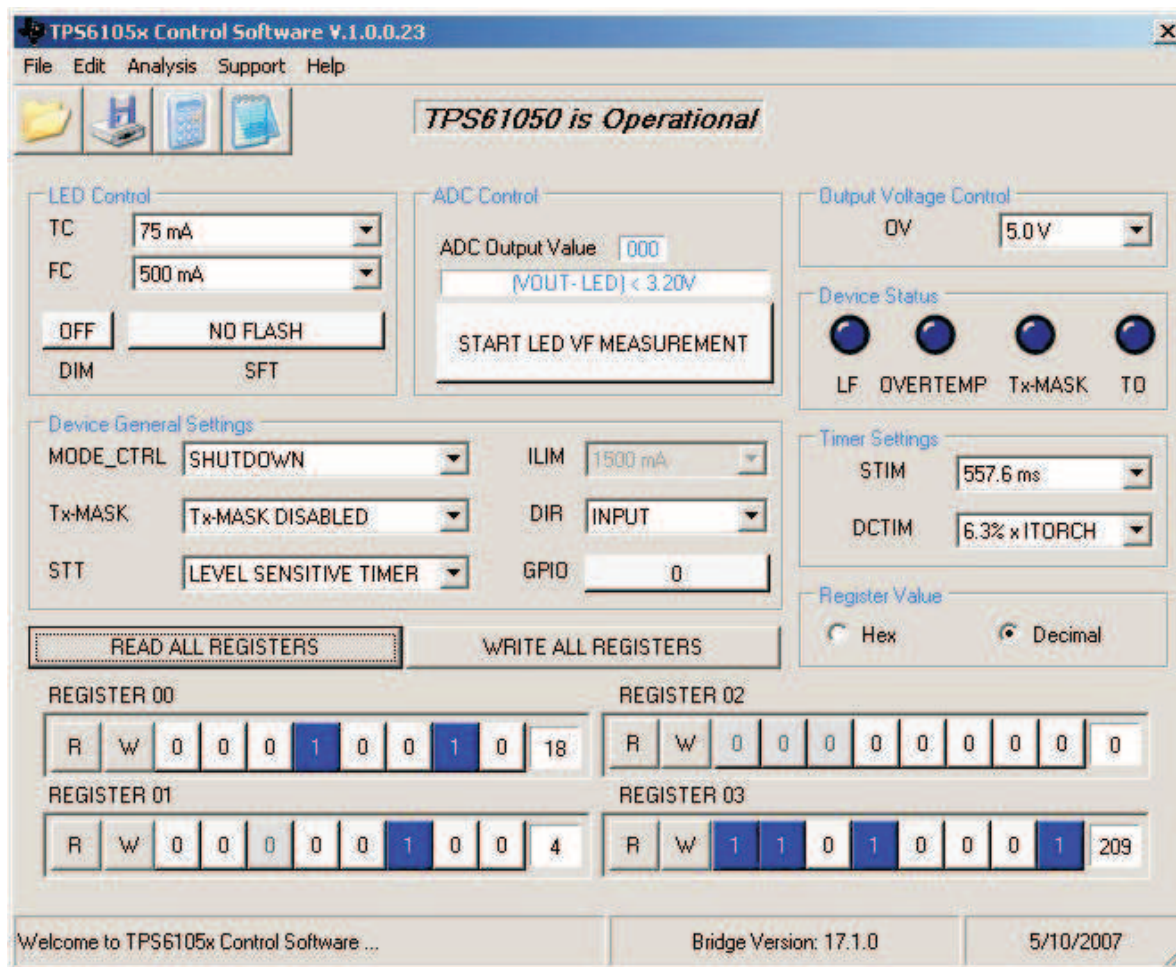

Figure 1. TPS6105x Software Main Panel

It is recommended that the user press the READ ALL REGISTERS button immediately after loading the software to confirm that the software and cable connections are working properly. The message box at the top right of the control panel displays whether or not the TPS61050/2 is operational and the middle message box at the bottom displays whether or not the USB-TO-GPIO connection is functional.

The software itself performs no calculations or computations and simply reads and writes to and from the IC's four registers through the I²C interface. Each register's bits can either be changed manually by changing the buttons corresponding to each bit in the panel's bottom half, or they can be changed through the drop-down boxes and buttons in the panel's top half. Bits or drop-down boxes that are greyed-out are either read (display) only or not operational. For example, since the TPS61052 does not have a GPIO pin, the main panel that appears when the user selects the TPS61052 IC has the GPIO related box, button and bits greyed-out. *Following any change to an individual bit, drop-down box or button, the user must write the new values to the registers by either clicking the red W button to the left of each affected register or by clicking the WRITE ALL REGISTERS button in the middle of the screen. It is recommended but not required that the user click the red R to the left of register or click READ ALL REGISTERS following each software write to the register or board level change (e.g., pressing S1/S2 to initiate a FLASH event).*

Although the data sheet explains each register, the explanation of the functionality of register 2 is reiterated in this user's guide. Writing to the ILIM and STIM bits of register 2 is allowed prior to the first flash event following the IC's power on. Writing to bits 5 and 6 of register 2 sets the ILIM bits which is the IC's current limit. This current limit value cannot be read back because performing a read of bits 3, 4 and 5 of register 2 results in the last valid ADC measurement. *For these reasons, even though the IC allows writing to both ILIM and STIM bits prior to the first flash event, following the IC's power on, the EVM software only allows the user to set the current limit when the software is initializing, following IC power on. The current limit drop-down box is greyed-out and only displays the selection previously made and written to the IC. In order to change current limit, the IC must be power cycled and the software must be shut down and re-started.* Otherwise, on a READ, the current limit drop down box displays the wrong current limit value as bit 5 of register 2, the most significant bit of the ADC value, changes. The inductor installed on the EVM has a saturation current of 1.5-A; therefore, the current limit for the EVM as built should not be set higher than 1.5 A. Also, a valid ADC measurement is only taken after a FLASH event, either through the board's push-button switch, by clicking the SFT button, followed by a WRITE or by clicking the main panel's START MEASUREMENT button, followed by a WRITE. However, after each READ, the software displays the current bits in the ADC register, which is the last valid ADC measurement taken.

4 Test Results

This section provides typical performance waveforms for the TPS61050/2EVM-269 board.

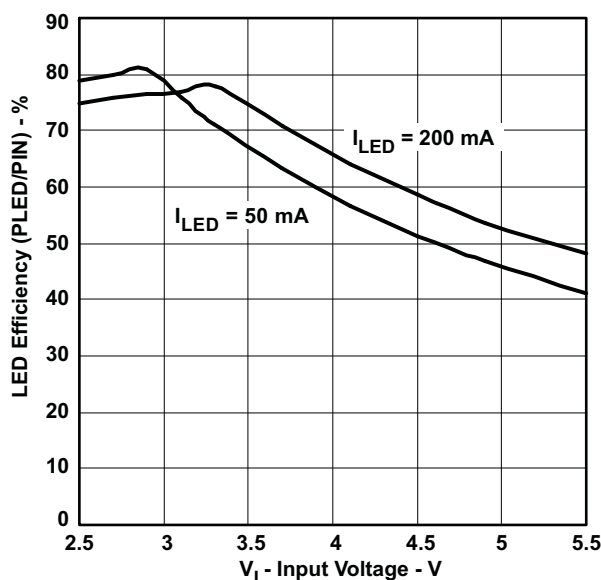

Figure 2. LED Efficiency vs. Input Voltage - Torch Mode

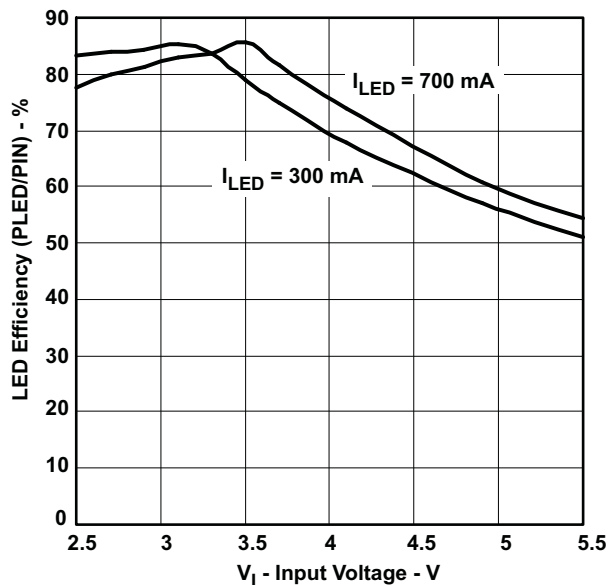

Figure 3. LED Efficiency vs. Input voltage - Single Pulse Flash Mode

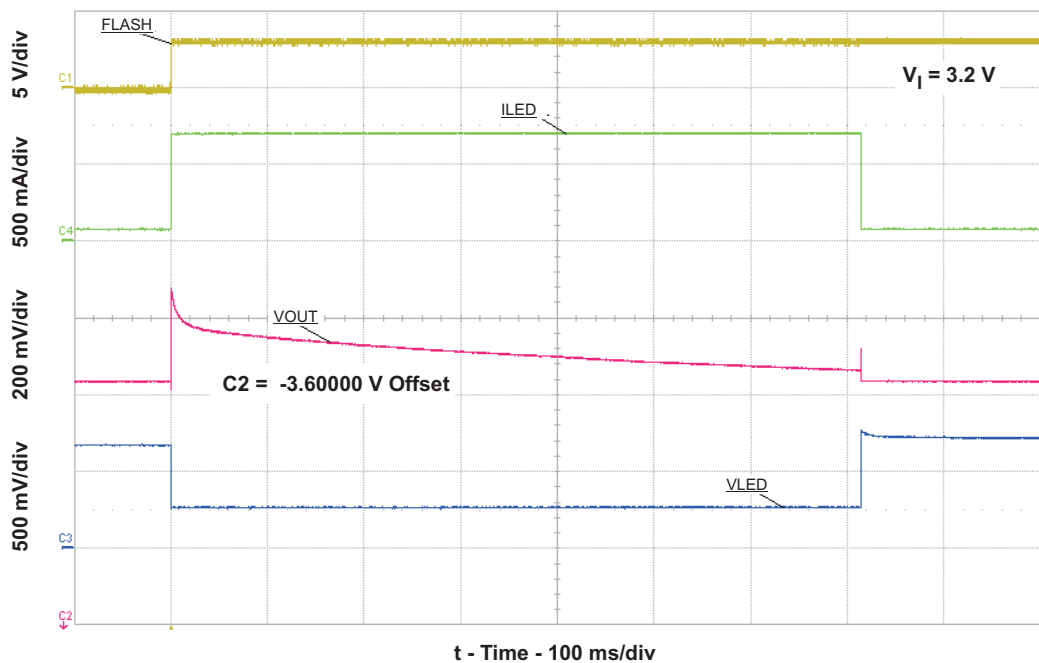

Figure 4. Torch Flash Sequence

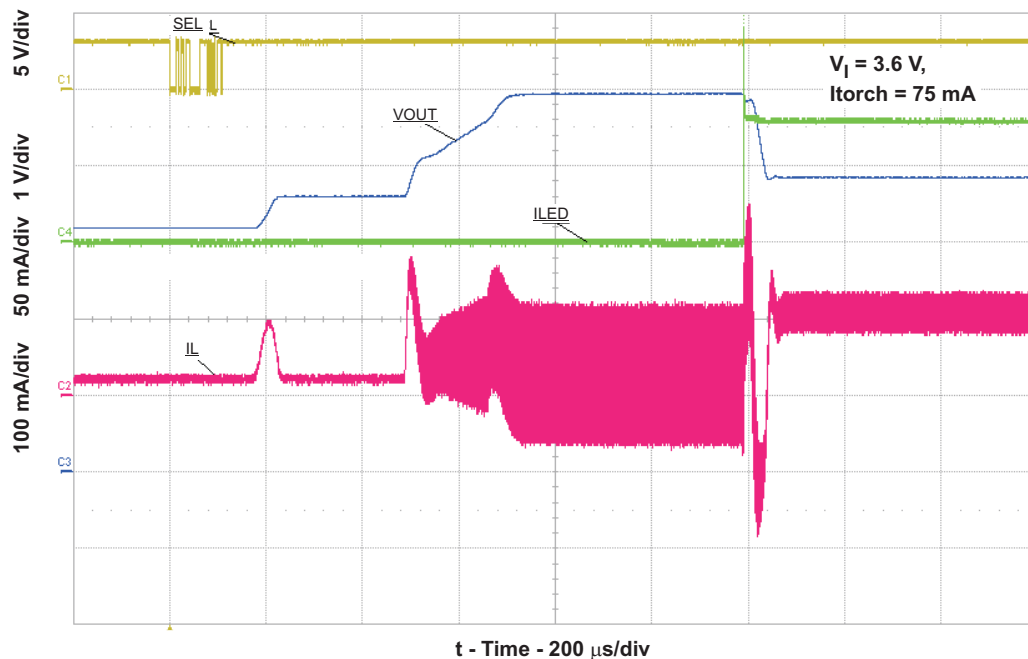

Figure 5. Start Up in Torch

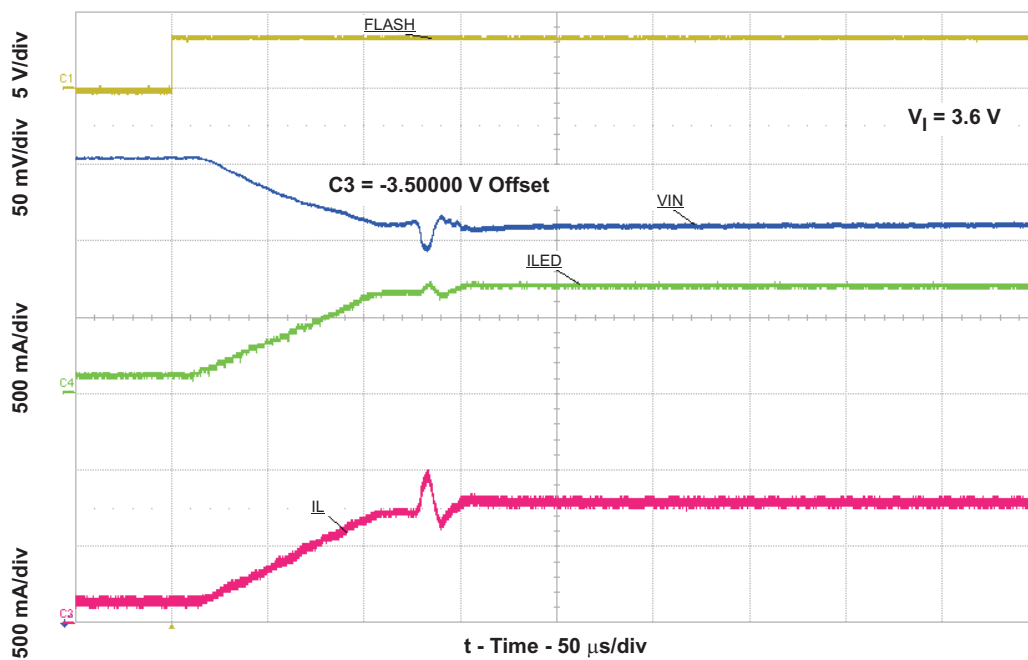

Figure 6. Inrush Current at Flash

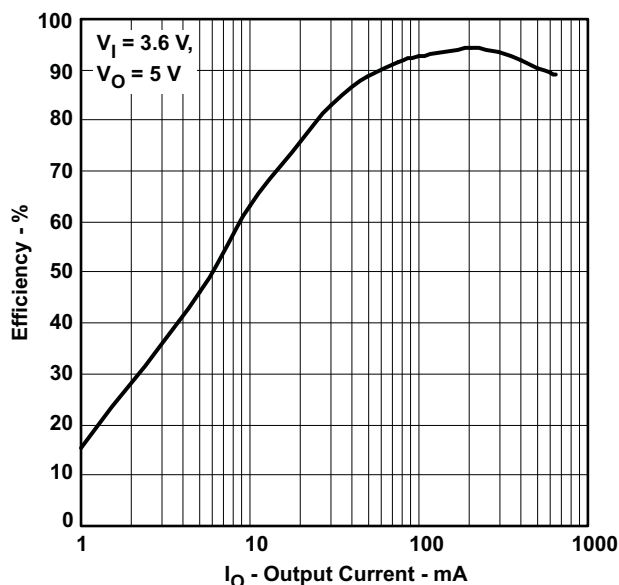

Figure 7. Voltage Mode Efficiency

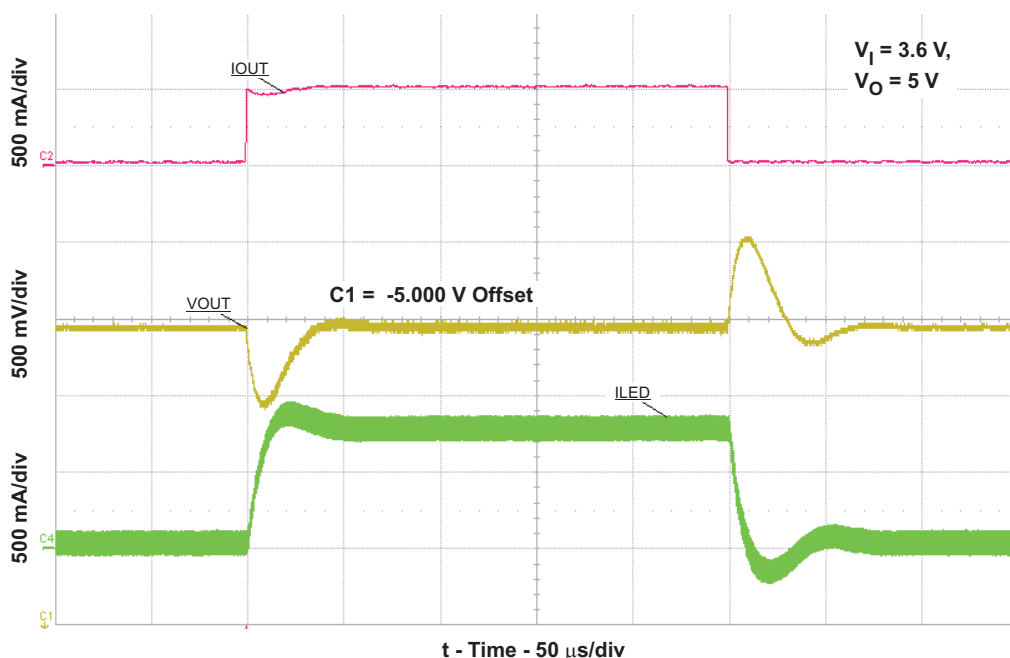

Figure 8. Voltage Mode Load Transient

5 Board Layout

This section provides the TPS61050/2EVM-269 board layout and illustrations.

Board layout is critical for all high-frequency, switch-mode power supplies. [Figure 9](#) through [Figure 12](#) show the board layout for the TPS61050/2EVM-269 PCB. The nodes with high-switching frequencies and currents are kept as short as possible to minimize trace inductance. Careful attention has been given to the routing of high-frequency current loops and a single-point grounding scheme is used. Also, the majority of the heatsinking for this device occurs through the top layer traces and vias pulled from the IC's solder bumps that carry high currents. See the data sheet for specific layout guidelines.

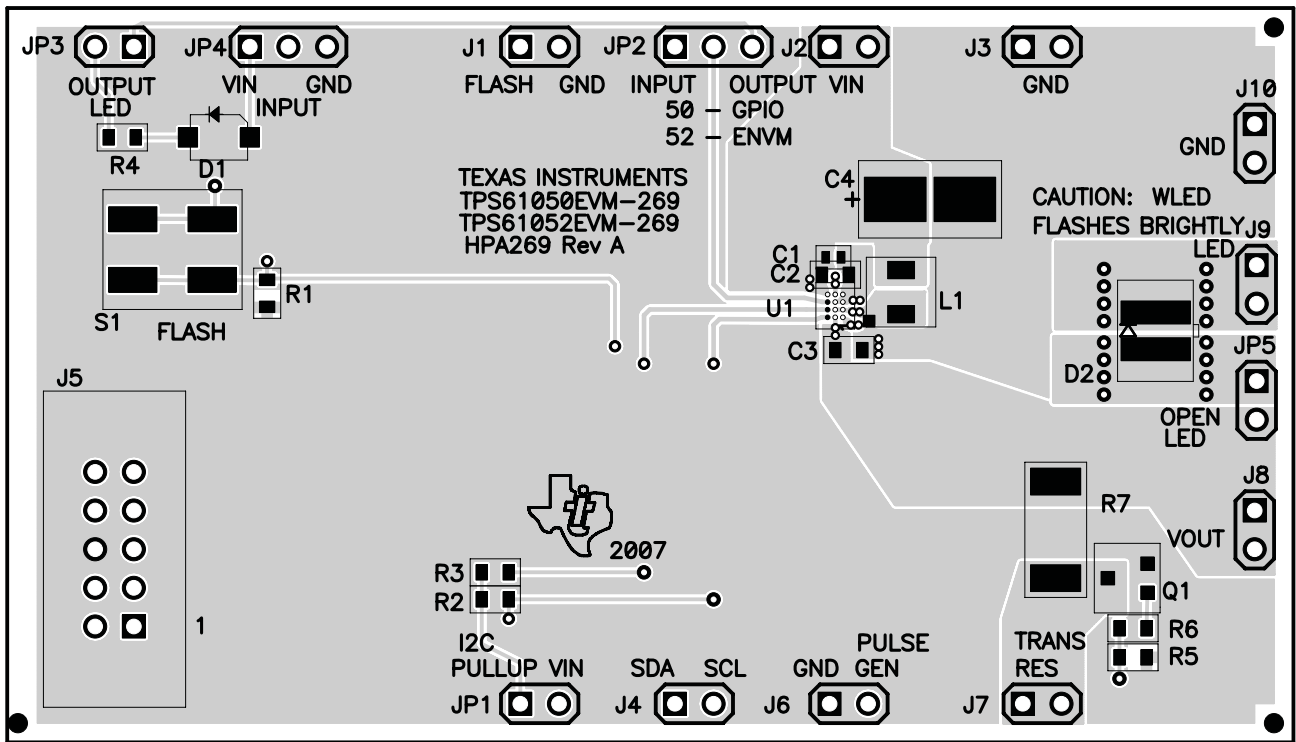

Figure 9. Assembly Layer

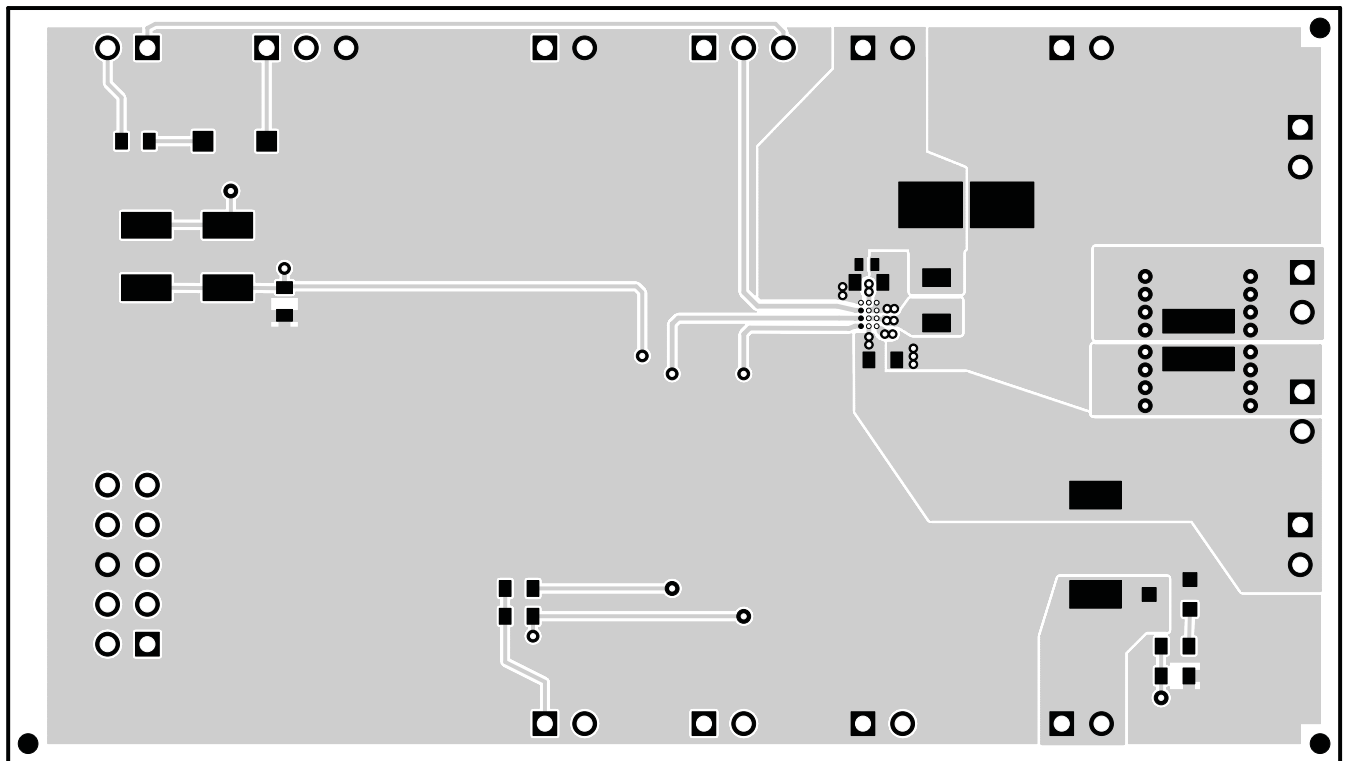

Figure 10. Top Layer

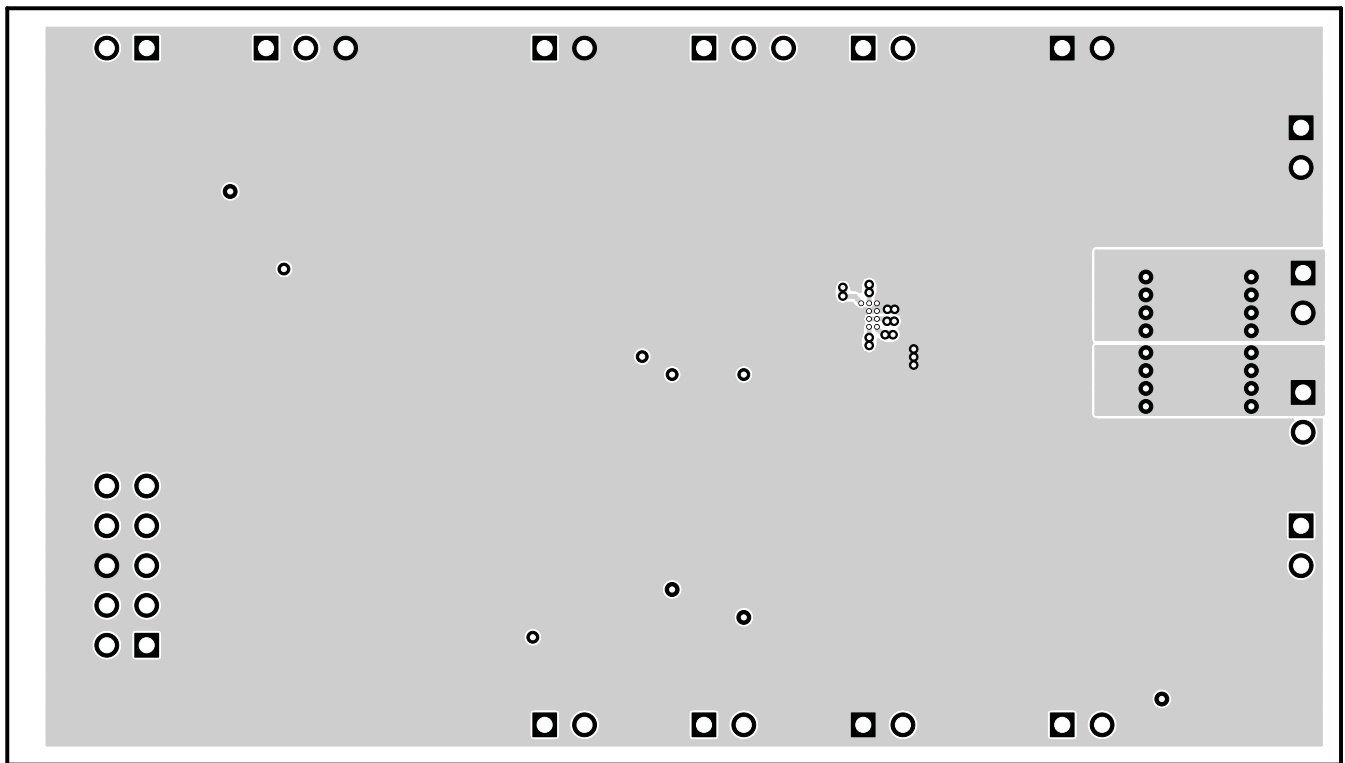

Figure 11. Layer 2

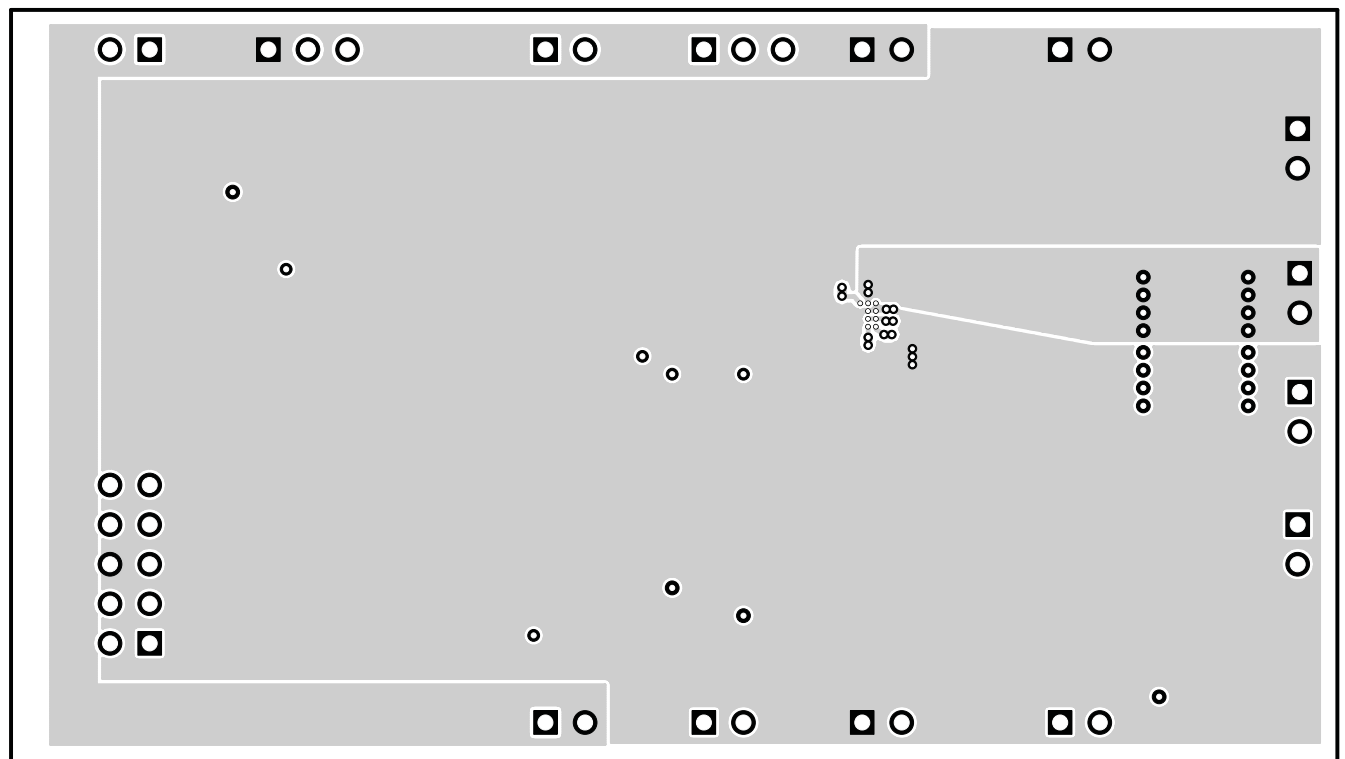

Figure 12. Layer 3

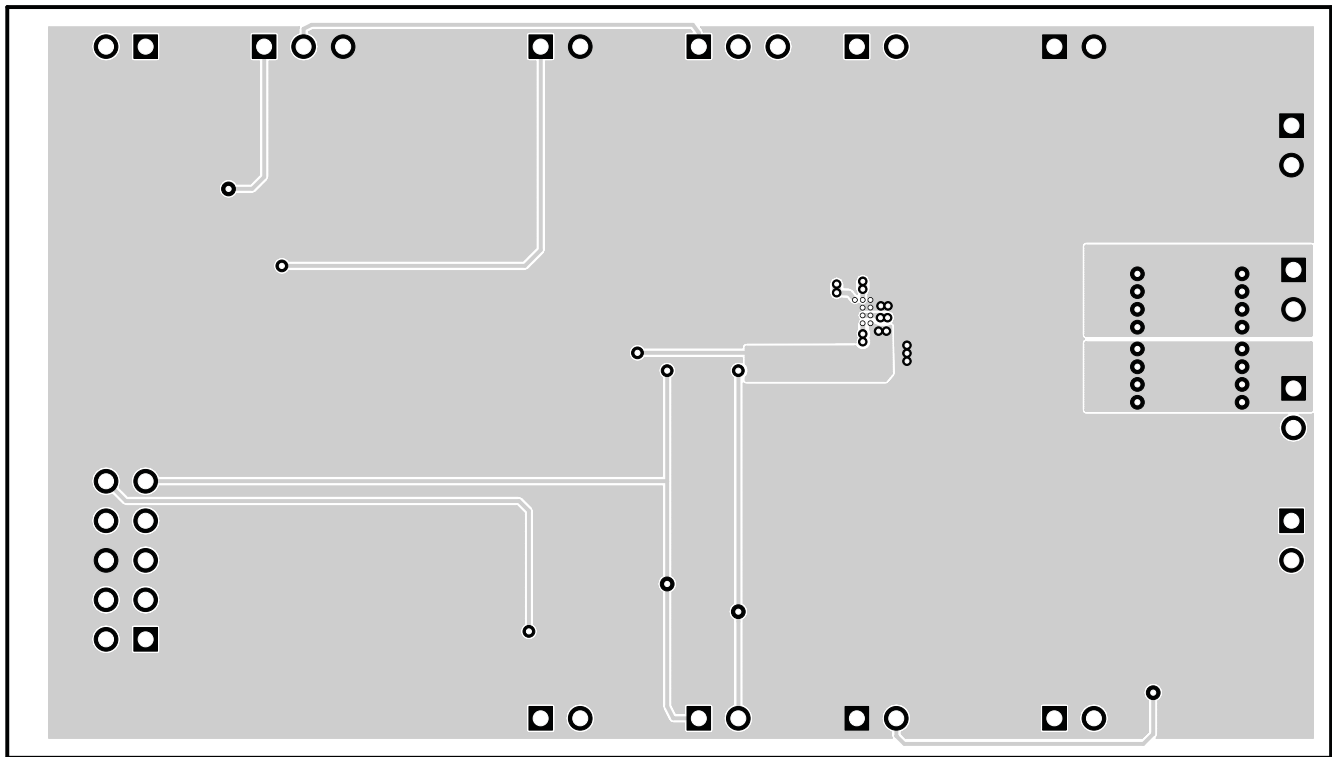

Figure 13. Bottom Layer

6 Schematics and Bill of Materials

This section provides the TPS61050/2EVM-215 schematic and bill of materials.

6.1 Schematics

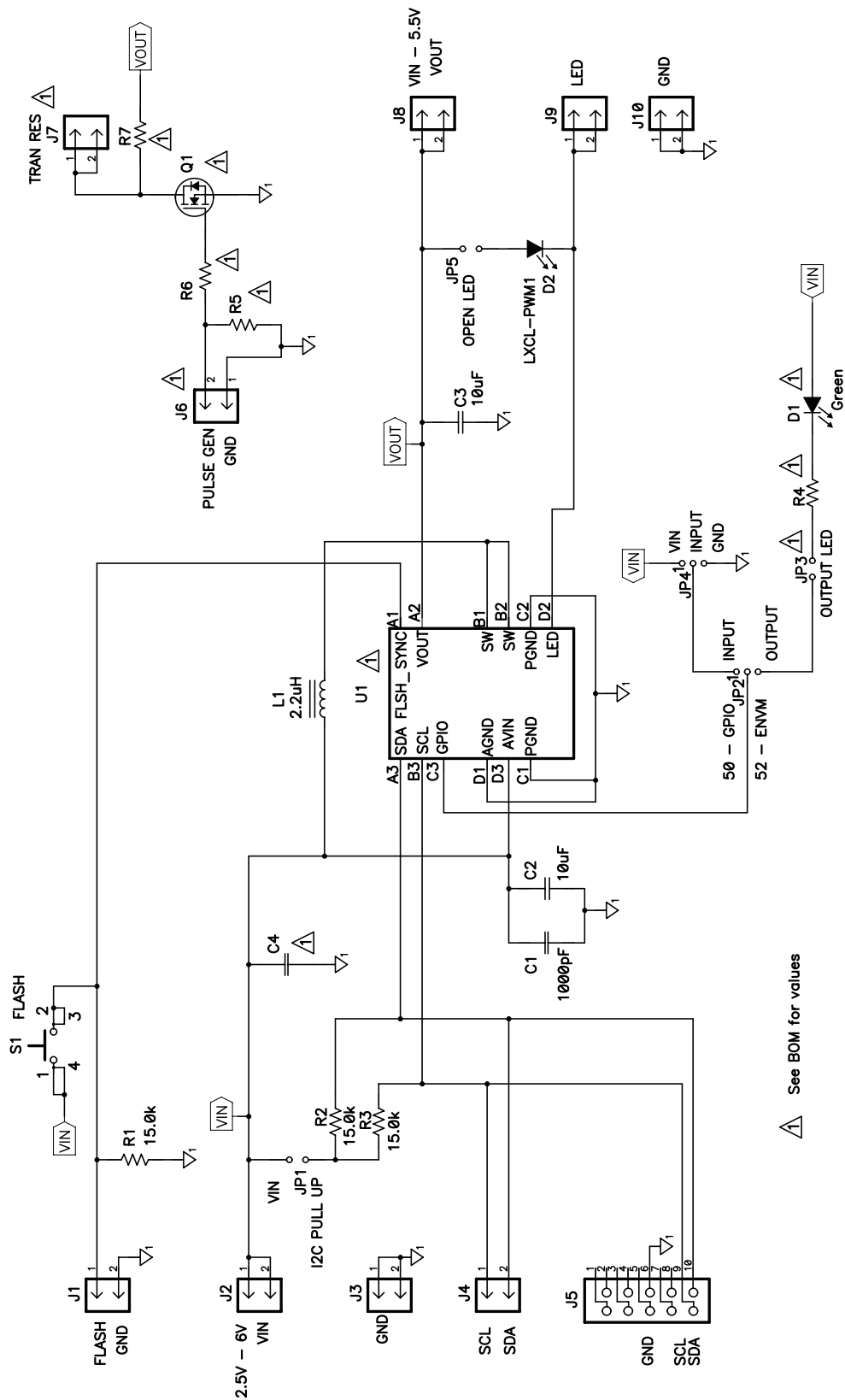

Figure 14. TPS61050/2EVM-269 Schematic

6.2 Bill of Materials

Table 2. TPS61050EVM-269 and TPS61052EVM-269 (HPA269-001 and HPA269-002) Bill of Materials

COUNT		Ref Des	Value	Description	Size	Part Number	MFR
-001	-002						
1	1	C1	1000pF	Capacitor, Ceramic, 50V, C0G, 5%	0402	GRM1555C1H102JA01D	muRata
2	2	C2, C3	10uF	Capacitor, Ceramic, 6.3V, X5R, 20%	0603	C1608X5R0J106MT	TDK
0	0	C4	Open	Capacitor, Multipattern, 603 - D Case	7343 (D)		
1	0	D1		Diode, LED, Green, Gullwing, GW Type, 20ma, 7.5 mcd typ.	0.120 x 0.087	LN1361CTR	Panasonic
1	1	D2		LED, White, 350mA	0.166 X 0.232	LXCL-PWM1	Lumileds
7	7	J1 - J4, J8 - J10		Header, 2 pin, 100mil spacing, (36-pin strip)	0.100 x 2	PTC36SAAN	Sullins
1	1	J5		Connector, Male Straight 2x5 pin, 100mil spacing, 4 Wall	0.338 x 0.788	2510-6002UB	3M
0	0	J6, J7		Header, 2 pin, 100mil spacing, (36-pin strip)	0.100 x 2	PTC36SAAN	Sullins
2	2	JP1, JP5		Header, 2 pin, 100mil spacing, (36-pin strip)	0.100 x 2	PTC36SAAN	Sullins
1	0	JP3		Header, 2 pin, 100mil spacing, (36-pin strip)	0.100 x 2	PTC36SAAN	Sullins
2	2	JP2, JP4		Header, 3 pin, 100mil spacing, (36-pin strip)	0.100 x 3	PTC36SAAN	Sullins
1	1	L1	2.2uH	Inductor, SMT, 2.3A, 160milliohm	0.130 X 0.130	FDSE0312-2R2M	Toko
0	0	Q1	Open	MOSFET, N-ch	SOT23		
3	3	R1, R2, R3	15k	Resistor, Chip, 1/16W, 1%	0603	Std	Std
1	0	R4	249	Resistor, Chip, 1/16W, 1%	0603	Std	Std
0	0	R5, R6	Open	Resistor, Chip, 1/16W, 1%	0603		
0	0	R7	Open	Resistor, Chip, 1W, 1%	2512		
1	1	S1		Switch, SPST, PB Momentary, Sealed Washable	0.245 X 0.251	KT11P2JM	C & K
1	0	U1		IC, Synchronous Boost Converter With I C Compatible Interface High Power White LED Driver	BGA	TPS61050YZG	TI
0	1			IC, Synchronous Boost Converter With I C Compatible Interface High Power White LED Driver	BGA	TPS61052YZG	TI
1	1	--		PCB, 3.35 In x 1.9 In x 0.062 In		HPA269	Any
3	2	--		Shunt, 100 mil, Black	0.100	929950-00	3M

6.3 Related Documentation From Texas Instruments

TPS61050, $\dot{P}C^{TM}$ Compatible Interface in Chip Scale Packaging data sheet ([SLUS525](#))

EVALUATION BOARD/KIT IMPORTANT NOTICE

Texas Instruments (TI) provides the enclosed product(s) under the following conditions:

This evaluation board/kit is intended for use for **ENGINEERING DEVELOPMENT, DEMONSTRATION, OR EVALUATION PURPOSES ONLY** and is not considered by TI to be a finished end-product fit for general consumer use. Persons handling the product(s) must have electronics training and observe good engineering practice standards. As such, the goods being provided are not intended to be complete in terms of required design-, marketing-, and/or manufacturing-related protective considerations, including product safety and environmental measures typically found in end products that incorporate such semiconductor components or circuit boards. This evaluation board/kit does not fall within the scope of the European Union directives regarding electromagnetic compatibility, restricted substances (RoHS), recycling (WEEE), FCC, CE or UL, and therefore may not meet the technical requirements of these directives or other related directives.

Should this evaluation board/kit not meet the specifications indicated in the User's Guide, the board/kit may be returned within 30 days from the date of delivery for a full refund. **THE FOREGOING WARRANTY IS THE EXCLUSIVE WARRANTY MADE BY SELLER TO BUYER AND IS IN LIEU OF ALL OTHER WARRANTIES, EXPRESSED, IMPLIED, OR STATUTORY, INCLUDING ANY WARRANTY OF MERCHANTABILITY OR FITNESS FOR ANY PARTICULAR PURPOSE.**

The user assumes all responsibility and liability for proper and safe handling of the goods. Further, the user indemnifies TI from all claims arising from the handling or use of the goods. Due to the open construction of the product, it is the user's responsibility to take any and all appropriate precautions with regard to electrostatic discharge.

EXCEPT TO THE EXTENT OF THE INDEMNITY SET FORTH ABOVE, NEITHER PARTY SHALL BE LIABLE TO THE OTHER FOR ANY INDIRECT, SPECIAL, INCIDENTAL, OR CONSEQUENTIAL DAMAGES.

TI currently deals with a variety of customers for products, and therefore our arrangement with the user **is not exclusive.**

TI assumes **no liability for applications assistance, customer product design, software performance, or infringement of patents or services described herein.**

Please read the User's Guide and, specifically, the Warnings and Restrictions notice in the User's Guide prior to handling the product. This notice contains important safety information about temperatures and voltages. For additional information on TI's environmental and/or safety programs, please contact the TI application engineer or visit www.ti.com/esh.

No license is granted under any patent right or other intellectual property right of TI covering or relating to any machine, process, or combination in which such TI products or services might be or are used.

FCC Warning

This evaluation board/kit is intended for use for **ENGINEERING DEVELOPMENT, DEMONSTRATION, OR EVALUATION PURPOSES ONLY** and is not considered by TI to be a finished end-product fit for general consumer use. It generates, uses, and can radiate radio frequency energy and has not been tested for compliance with the limits of computing devices pursuant to part 15 of FCC rules, which are designed to provide reasonable protection against radio frequency interference. Operation of this equipment in other environments may cause interference with radio communications, in which case the user at his own expense will be required to take whatever measures may be required to correct this interference.

Mailing Address: Texas Instruments, Post Office Box 655303, Dallas, Texas 75265
Copyright © 2007, Texas Instruments Incorporated

EVM WARNINGS AND RESTRICTIONS

It is important to operate this EVM within the input voltage range of 2.7 V to 6 V and the output voltage range of V_{in} to 5.5 V.

Exceeding the specified input range may cause unexpected operation and/or irreversible damage to the EVM. If there are questions concerning the input range, please contact a TI field representative prior to connecting the input power.

Applying loads outside of the specified output range may result in unintended operation and/or possible permanent damage to the EVM. Please consult the EVM User's Guide prior to connecting any load to the EVM output. If there is uncertainty as to the load specification, please contact a TI field representative.

During normal operation, some circuit components may have case temperatures greater than 85°C. The EVM is designed to operate properly with certain components above 85°C as long as the input and output ranges are maintained. These components include but are not limited to linear regulators, switching transistors, pass transistors, and current sense resistors. These types of devices can be identified using the EVM schematic located in the EVM User's Guide. When placing measurement probes near these devices during operation, please be aware that these devices may be very warm to the touch.

Mailing Address: Texas Instruments, Post Office Box 655303, Dallas, Texas 75265
Copyright © 2007, Texas Instruments Incorporated

IMPORTANT NOTICE

Texas Instruments Incorporated and its subsidiaries (TI) reserve the right to make corrections, modifications, enhancements, improvements, and other changes to its products and services at any time and to discontinue any product or service without notice. Customers should obtain the latest relevant information before placing orders and should verify that such information is current and complete. All products are sold subject to TI's terms and conditions of sale supplied at the time of order acknowledgment.

TI warrants performance of its hardware products to the specifications applicable at the time of sale in accordance with TI's standard warranty. Testing and other quality control techniques are used to the extent TI deems necessary to support this warranty. Except where mandated by government requirements, testing of all parameters of each product is not necessarily performed.

TI assumes no liability for applications assistance or customer product design. Customers are responsible for their products and applications using TI components. To minimize the risks associated with customer products and applications, customers should provide adequate design and operating safeguards.

TI does not warrant or represent that any license, either express or implied, is granted under any TI patent right, copyright, mask work right, or other TI intellectual property right relating to any combination, machine, or process in which TI products or services are used. Information published by TI regarding third-party products or services does not constitute a license from TI to use such products or services or a warranty or endorsement thereof. Use of such information may require a license from a third party under the patents or other intellectual property of the third party, or a license from TI under the patents or other intellectual property of TI.

Reproduction of TI information in TI data books or data sheets is permissible only if reproduction is without alteration and is accompanied by all associated warranties, conditions, limitations, and notices. Reproduction of this information with alteration is an unfair and deceptive business practice. TI is not responsible or liable for such altered documentation. Information of third parties may be subject to additional restrictions.

Resale of TI products or services with statements different from or beyond the parameters stated by TI for that product or service voids all express and any implied warranties for the associated TI product or service and is an unfair and deceptive business practice. TI is not responsible or liable for any such statements.

TI products are not authorized for use in safety-critical applications (such as life support) where a failure of the TI product would reasonably be expected to cause severe personal injury or death, unless officers of the parties have executed an agreement specifically governing such use. Buyers represent that they have all necessary expertise in the safety and regulatory ramifications of their applications, and acknowledge and agree that they are solely responsible for all legal, regulatory and safety-related requirements concerning their products and any use of TI products in such safety-critical applications, notwithstanding any applications-related information or support that may be provided by TI. Further, Buyers must fully indemnify TI and its representatives against any damages arising out of the use of TI products in such safety-critical applications.

TI products are neither designed nor intended for use in military/aerospace applications or environments unless the TI products are specifically designated by TI as military-grade or "enhanced plastic." Only products designated by TI as military-grade meet military specifications. Buyers acknowledge and agree that any such use of TI products which TI has not designated as military-grade is solely at the Buyer's risk, and that they are solely responsible for compliance with all legal and regulatory requirements in connection with such use.

TI products are neither designed nor intended for use in automotive applications or environments unless the specific TI products are designated by TI as compliant with ISO/TS 16949 requirements. Buyers acknowledge and agree that, if they use any non-designated products in automotive applications, TI will not be responsible for any failure to meet such requirements.

Following are URLs where you can obtain information on other Texas Instruments products and application solutions:

Products		Applications	
Amplifiers	amplifier.ti.com	Audio	www.ti.com/audio
Data Converters	dataconverter.ti.com	Automotive	www.ti.com/automotive
DSP	dsp.ti.com	Broadband	www.ti.com/broadband
Interface	interface.ti.com	Digital Control	www.ti.com/digitalcontrol
Logic	logic.ti.com	Military	www.ti.com/military
Power Mgmt	power.ti.com	Optical Networking	www.ti.com/opticalnetwork
Microcontrollers	microcontroller.ti.com	Security	www.ti.com/security
RFID	www.ti-rfid.com	Telephony	www.ti.com/telephony
Low Power Wireless	www.ti.com/lpw	Video & Imaging	www.ti.com/video
		Wireless	www.ti.com/wireless

Mailing Address: Texas Instruments, Post Office Box 655303, Dallas, Texas 75265
Copyright © 2007, Texas Instruments Incorporated