

4N39X, 4N40X  
4N39, 4N40



**PHOTON COUPLED ISOLATOR Ga As  
INFRARED EMITTING DIODE &  
LIGHT ACTIVATED SCR**

**APPROVALS**

- UL recognised, File No. E91231

**'X' SPECIFICATION APPROVALS**

- VDE 0884 in 2 available lead forms : -  
- STD  
- G form

**DESCRIPTION**

The 4N39, 4N40 are optically coupled isolators consisting of infrared light emitting diode and a light activated silicon controlled rectifier in a standard 6pin dual in line plastic package.

**FEATURES**

- Options :-  
10mm lead spread - add G after part no.  
Surface mount - add SM after part no.  
Tape&reel - add SMT&R after part no.
- High Isolation Voltage (5.3kV<sub>RMS</sub>, 7.5kV<sub>PK</sub>)
- High Surge Anode Current (5.0 A)
- High Blocking Voltage (200V\*1, 400V\*1)
- Low Turn on Current (5mA typical)
- All electrical parameters 100% tested
- Custom electrical selections available

**APPLICATIONS**

- 10A, TTL compatible, Solid State Relay
- 25W Logic Indicator Lamp Driver
- 400V Symmetrical transistor coupler

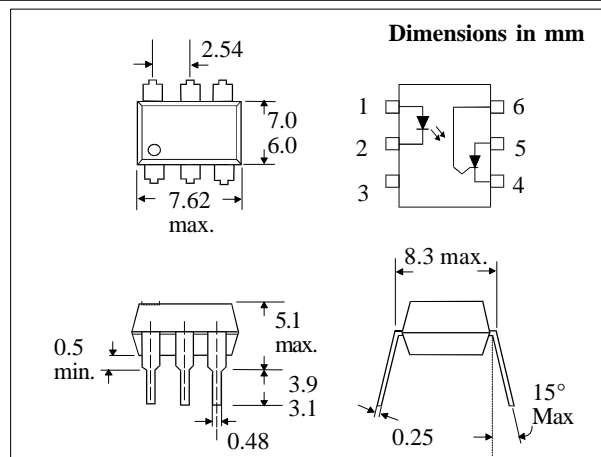
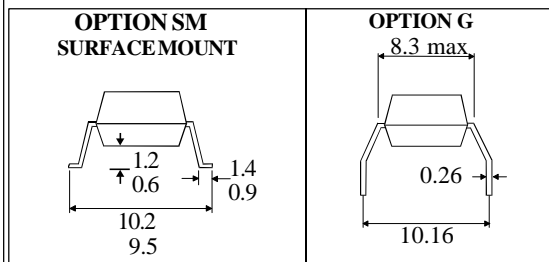

**ABSOLUTE MAXIMUM RATINGS  
(25°C unless otherwise specified)**

Storage Temperature \_\_\_\_\_ -55°C to + 150°C  
Operating Temperature \_\_\_\_\_ -55°C to + 100°C  
Lead Soldering Temperature  
(1/16 inch (1.6mm) from case for 10 secs) 260°C

**INPUT DIODE**

Forward Current \_\_\_\_\_ 60mA  
Forward Current (Peak)  
(1µs pulse, 300pps) \_\_\_\_\_ 3A  
Reverse Voltage \_\_\_\_\_ 6V  
Power Dissipation \_\_\_\_\_ 100mW

**DETECTOR**

Peak Forward Voltage  
4N39 \_\_\_\_\_ 200V\*1  
4N40 \_\_\_\_\_ 400V\*1  
Peak Reverse Gate Voltage \_\_\_\_\_ 6V  
RMS On-state Current \_\_\_\_\_ 300mA  
Peak On-state Current  
(100µs, 1% duty cycle) \_\_\_\_\_ 10A  
Surge Current (10ms) \_\_\_\_\_ 5A  
Power Dissipation \_\_\_\_\_ 300mW

\*1 IMPORTANT : A resistor must be connected between gate and cathode (pins 4 & 6) to prevent false firing ( $R_{GK} < 56k\Omega$ )

**ISOCOM COMPONENTS LTD**  
Unit 25B, Park View Road West,  
Park View Industrial Estate, Brenda Road  
Hartlepool, Cleveland, TS25 1YD  
Tel: (01429) 863609 Fax : (01429) 863581

**ISOCOM INC**  
1024 S. Greenville Ave, Suite 240,  
Allen, TX 75002 USA  
Tel: (214)495-0755 Fax: (214)495-0901  
e-mail info@isocom.com  
http://www.isocom.com

**ELECTRICAL CHARACTERISTICS (  $T_A = 25^\circ\text{C}$  Unless otherwise noted )**

PARAMETER		MIN	TYP	MAX	UNITS	TEST CONDITION
Input	Forward Voltage ( $V_F$ )		1.2	1.5	V	$I_F = 10\text{mA}$
	Reverse Voltage ( $V_R$ )	3			V	$I_R = 10\mu\text{A}$
Output (note 2)	Peak Off-state Voltage ( $V_{DM}$ ) 4N39	200			V	$R_{GK}=10\text{k}\Omega$ , $I_D=50\mu\text{A}$ , $T_A=100^\circ\text{C}$
	4N40	400			V	$R_{GK}=10\text{k}\Omega$ , $I_D=150\mu\text{A}$ , $T_A=100^\circ\text{C}$
	Peak Reverse Voltage ( $V_{RM}$ ) 4N39	200			V	$R_{GK}=10\text{k}\Omega$ , $I_D=50\mu\text{A}$ , $T_A=100^\circ\text{C}$
	4N40	400			V	$R_{GK}=10\text{k}\Omega$ , $I_D=150\mu\text{A}$ , $T_A=100^\circ\text{C}$
	On-state Voltage ( $V_{TM}$ )		1.1	1.3	V	$I_{TM} = 300\text{mA}$
	Off-state Current ( $I_{DM}$ ) 4N39			50	$\mu\text{A}$	$R_{GK}=10\text{k}\Omega$ , $I_F=0$ , $V_{DM}=200\text{V}$ , $T_A=100^\circ\text{C}$
	4N40			150	$\mu\text{A}$	$R_{GK}=10\text{k}\Omega$ , $I_F=0$ , $V_{DM}=400\text{V}$ , $T_A=100^\circ\text{C}$
	Reverse Current ( $I_R$ ) 4N39			50	$\mu\text{A}$	$R_{GK}=10\text{k}\Omega$ , $I_F=0$ , $V_{DM}=200\text{V}$ , $T_A=100^\circ\text{C}$
	4N40			150	$\mu\text{A}$	$R_{GK}=10\text{k}\Omega$ , $I_F=0$ , $V_{DM}=400\text{V}$ , $T_A=100^\circ\text{C}$
	Holding Current ( $I_H$ )			1	mA	$R_{GK}=27\text{k}\Omega$ , $V_{FX}=50\text{V}$
Coupled	Input Current to Trigger ( $I_{FT}$ ) (note 2)			30 14	mA mA	$V_{AK}=50\text{V}$ , $R_{GK}=10\text{k}\Omega$ $V_{AK}=100\text{V}$ , $R_{GK}=27\text{k}\Omega$
	Turn on Time ( $t_{on}$ )			50	$\mu\text{s}$	$R_{GK}=10\text{k}\Omega$ , $I_F=30\text{mA}$ , $V_{AK}=50\text{V}$ , $R_L=200\Omega$
	Coupled dv/dt, Input to Output (dv/dt)	500			V/ $\mu\text{s}$	
	Input to Output Isolation Voltage $V_{ISO}$	5300 7500			$V_{RMS}$ $V_{PK}$	See note 1 See note 1
	Input-output Isolation Resistance $R_{ISO}$	$10^{11}$			$\Omega$	$V_{IO} = 500\text{V}$ (note 1)
	Input-output Capacitance $C_f$			2	pF	$V = 0$ , $f = 1\text{MHz}$

Note 1 Measured with input leads shorted together and output leads shorted together.

Note 2 Special Selections are available on request. Please consult the factory.

**Input Current to Trigger vs. Anode to Cathode Voltage**

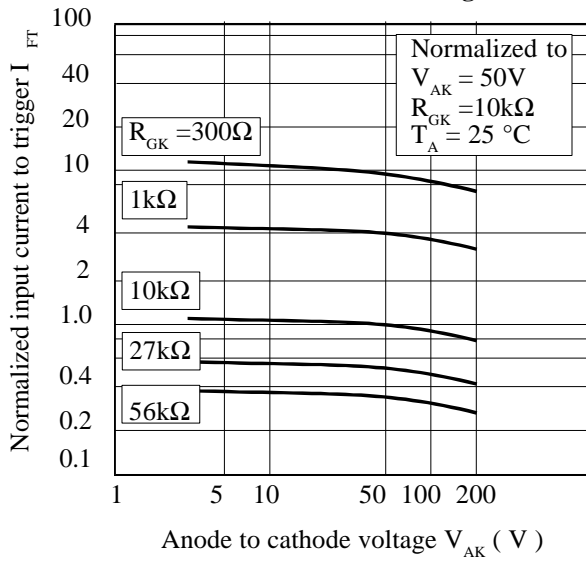

**Input Current to Trigger vs. Ambient Temperature**

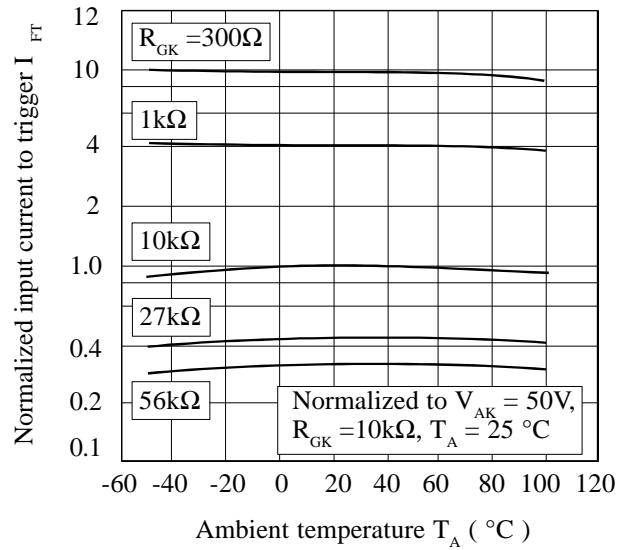

**Input Current to Trigger Distribution vs. Ambient Temperature**

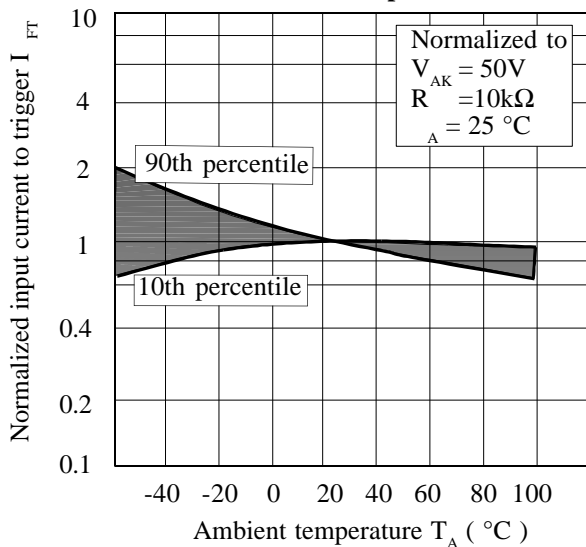

**Input Current to Trigger vs. Pulse Width**

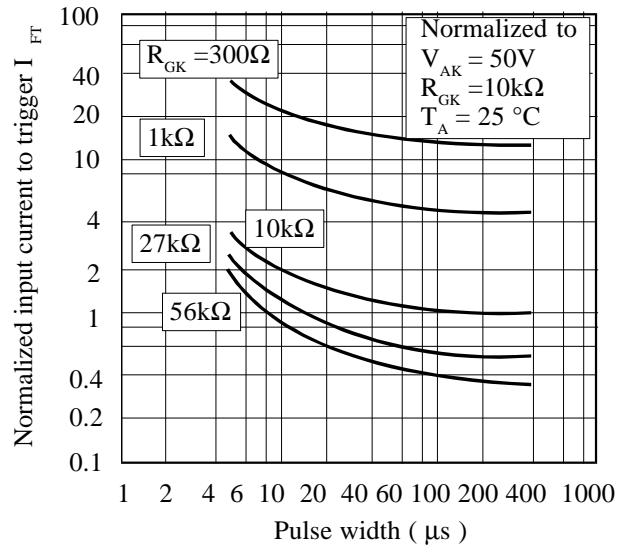

**Turn on Time vs. Input Current**

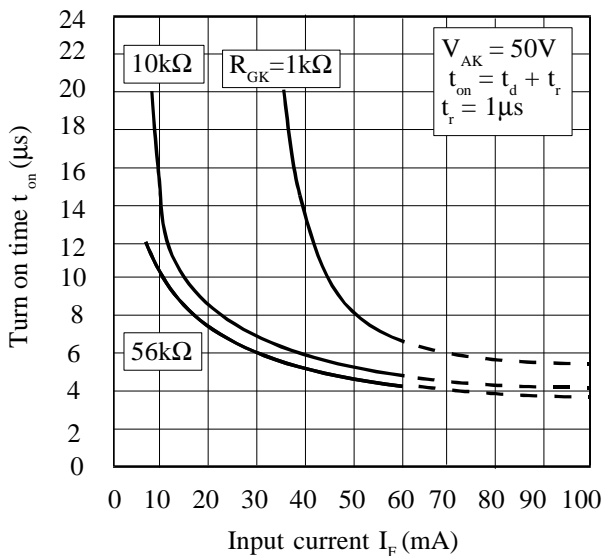

**Input Characteristics  $I_F$  vs.  $V_F$**

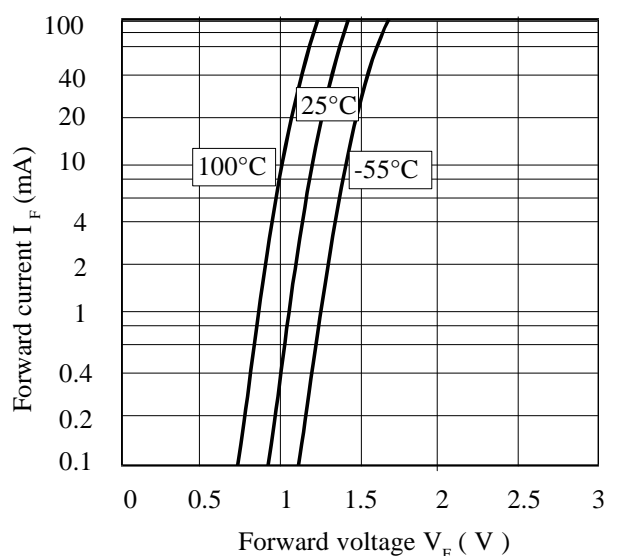

**Holding Current vs. Ambient Temperature**

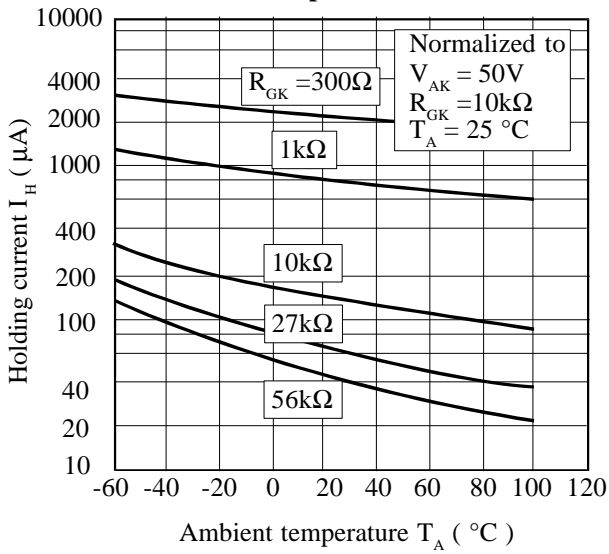

**Maximum Transient Thermal Impedance**

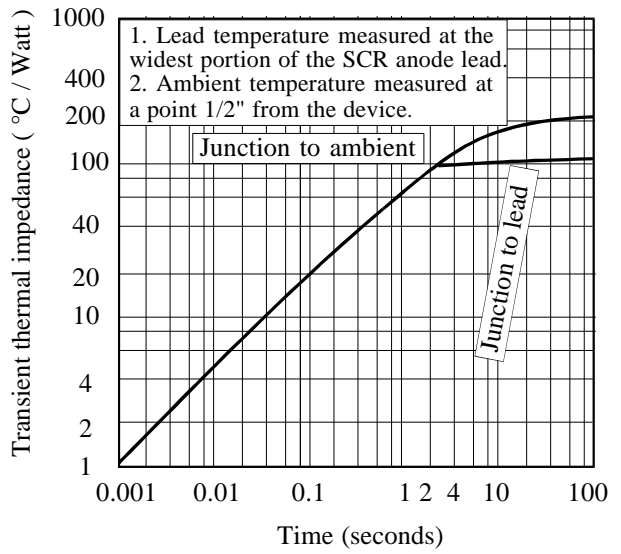

**Off State Forward Current vs. Ambient Temperature**

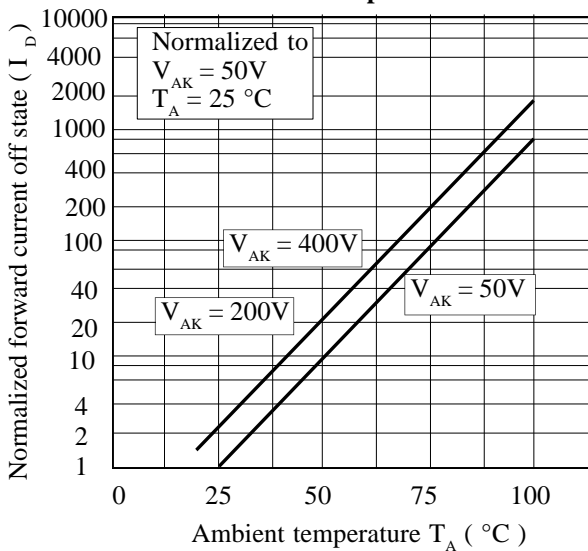

**On State Current vs. Maximum Allowable Temperature**

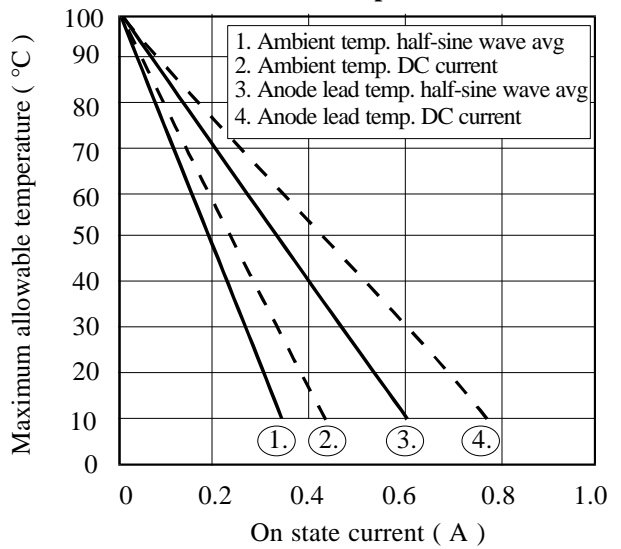

**dV/dt vs. Ambient temperature**

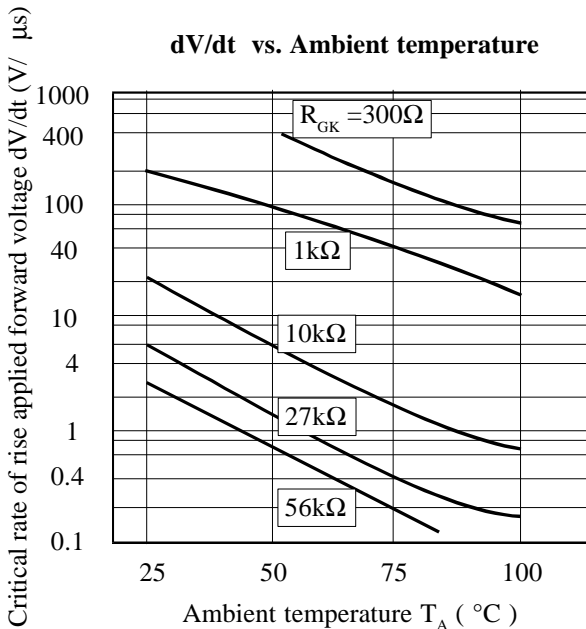

**On State Characteristics**

