

CMOS

Binary Rate Multiplier

High-Voltage Types (20-Volt Rating)

■ CD4089B is a low-power 4-bit digital rate multiplier that provides an output pulse rate that is the clock-input-pulse rate multiplied by 1/16 times the binary input. For example, when the binary input number is 13, there will be 13 output pulses for every 16 input pulses. This device may be used in conjunction with an up/down counter and control logic used to perform arithmetic operations (adds, subtract, divide, raise to a power), solve algebraic and differential equations, generate natural logarithms and trigonometric functions, A/D and D/A conversions, and frequency division.

For words of more than 4 bits, CD4089B devices may be cascaded in two different modes: an Add mode and a Multiply mode (see Figs. 14 and 15). In the Add mode some of the gaps left by the more significant unit at the count of 15 are filled in by the less significant units. For example, when two units are cascaded in the Add mode and programmed to 11 and 13, respectively, the more significant unit will have 11 output pulses for every 16 input pulses and the other unit will have 13 output pulses for every 256 input pulses for a total of

$$\frac{11}{16} + \frac{13}{256} = \frac{189}{256}$$

In the Multiply mode the fraction programmed into the first rate multiplier is multiplied by the fraction programmed into the second multiplier. Thus the output rate will be

$$\frac{11}{16} \times \frac{13}{16} = \frac{143}{256}$$

MAXIMUM RATINGS, Absolute-Maximum Values:

DC SUPPLY-VOLTAGE RANGE, (V _{DD}) Voltages referenced to V _{SS} Terminal	-0.5V to +20V
INPUT VOLTAGE RANGE, ALL INPUTS	-0.5V to V _{DD} +0.5V
DC INPUT CURRENT, ANY ONE INPUT	±10mA
POWER DISSIPATION PER PACKAGE (P _D):	
For T _A = -55°C to +100°C	500mW
For T _A = +100°C to +125°C	Derate Linearly at 12mW/°C to 200mW
DEVICE DISSIPATION PER OUTPUT TRANSISTOR	
FOR T _A = FULL PACKAGE-TEMPERATURE RANGE (All Package Types)	100mW
OPERATING-TEMPERATURE RANGE (T _A)	-55°C to +125°C
STORAGE TEMPERATURE RANGE (T _{stg})	-65°C to +150°C
LEAD TEMPERATURE (DURING SOLDERING):	
At distance 1/16 ± 1/32 inch (1.59 ± 0.79mm) from case for 10s max	+265°C

Features:

- Cascadable in multiples of 4-bits
- Set to "15" input and "15" detect output
- 100% tested for quiescent current at 20 V
- 5-V, 10-V, and 15-V parametric ratings
- Standardized, symmetrical output characteristics
- Maximum input current of 1 μA at 18 V over full package-temperature range; 100 nA at 18 V and 25°C
- Noise margin (full package-temperature range) =

- 1 V at V_{DD} = 5 V
- 2 V at V_{DD} = 10 V
- 2.5 V at V_{DD} = 15 V

- Meets all requirements of JEDEC Tentative Standard No. 13B, "Standard Specifications for Description of 'B' Series CMOS Devices"

Applications:

- Numerical control
- Instrumentation
- Digital filtering
- Frequency synthesis

The CD4089B has an internal synchronous 4-bit counter which, together with one of the four binary input bits, produces pulse trains as shown in Fig. 2.

If more than one binary input bit is high, the resulting pulse train is a combination of the separate pulse trains as shown in Fig. 2.

The CD4089B types are supplied in 16-lead hermetic dual-in-line ceramic packages (F3A suffix), 16-lead dual-in-line plastic packages (E suffix), 16-lead small-outline packages (NSR suffix), and 16-lead thin shrink small-outline packages (PW and PWR suffixes).

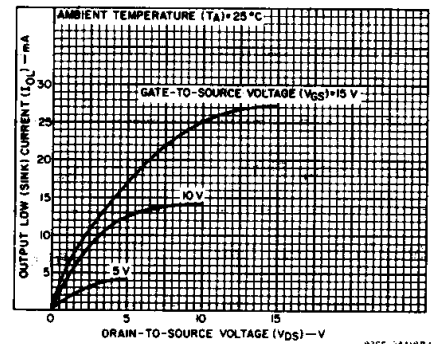
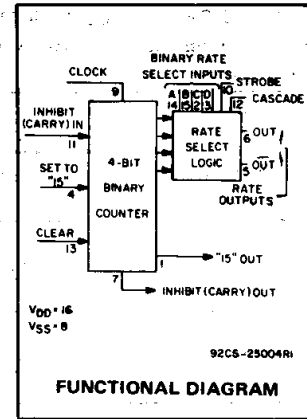

Fig. 1 – Typical output low (sink) current characteristics.

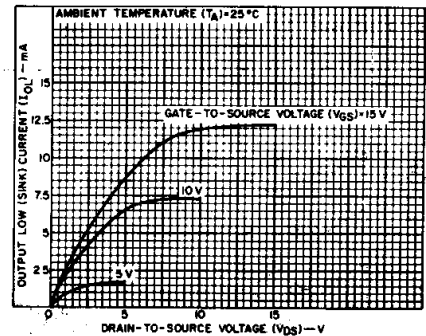

Fig. 2 – Minimum output low (sink) current characteristics.

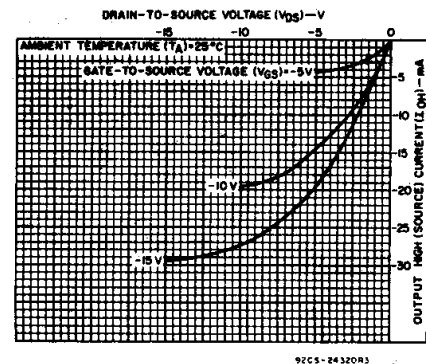

Fig. 3 – Typical output high (source) current characteristics.

3
COMMERCIAL CMOS
HIGH VOLTAGE ICs

CD4089B Types

RECOMMENDED OPERATING CONDITIONS at $T_A = 25^\circ\text{C}$, Except as Noted. For maximum reliability, nominal operating conditions should be selected so that operation is always within the following ranges:

CHARACTERISTIC	V_{DD} (V)	LIMITS		UNITS
		Min.	Max.	
Supply-Voltage Range (For T_A = Full Package-Temperature Range)		3	18	V
Set or Clear Pulse Width, t_W	5	160	—	ns
	10	90	—	
	15	60	—	
Clock Pulse Width, t_W	5	330	—	ns
	10	170	—	
	15	100	—	
Clock Frequency, f_{CL}	5	dc	1.2	MHz
	10	—	2.5	
	15	—	3.5	
Clock Rise or Fall Time, t_{rCL} or t_{fCL}	5, 10, 15	—	15	μs
Inhibit In Setup Time, t_{SU}	5	100	—	ns
	10	40	—	
	15	20	—	
Inhibit In Removal Time, t_{REM}	5	240	—	ns
	10	130	—	
	15	110	—	
Set Removal Time, t_{REM}	5	150	—	ns
	10	80	—	
	15	50	—	
Clear Removal Time, t_{REM}	5	60	—	ns
	10	40	—	
	15	30	—	

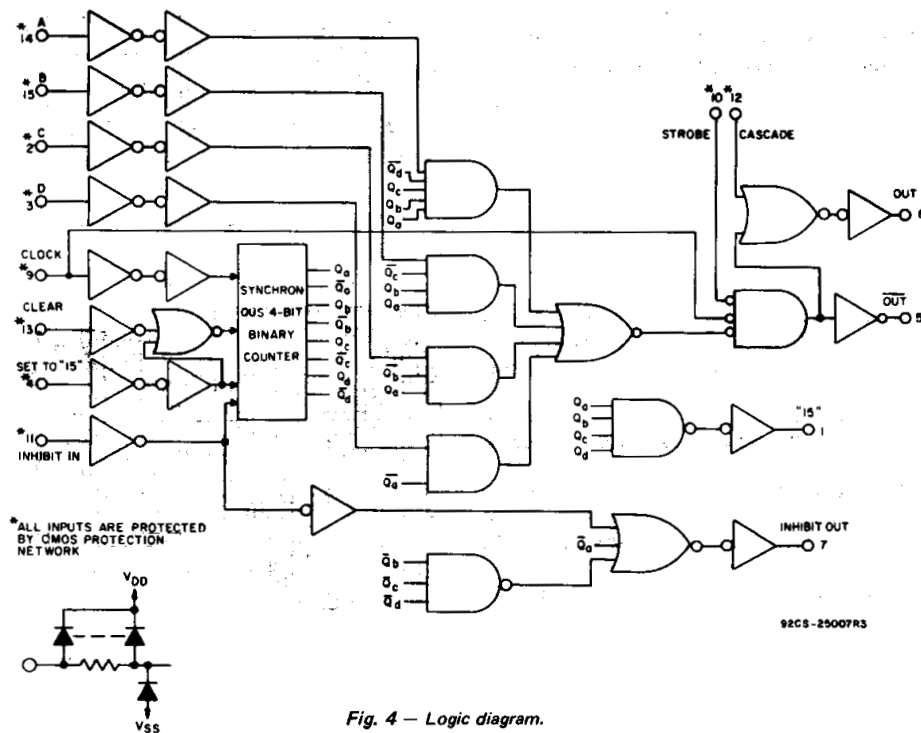

Fig. 4 — Logic diagram.

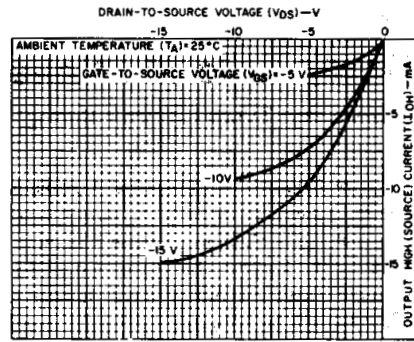

Fig. 5 — Minimum output high (source) current characteristics.

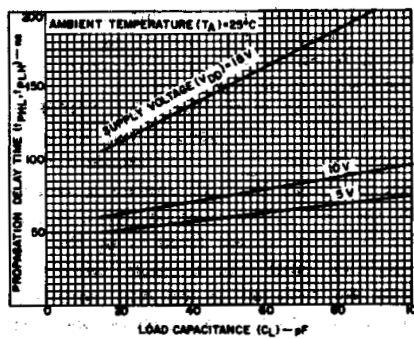

Fig. 6 — Typical propagation delay time as a function of load capacitance (Clock or Strobe to Out).

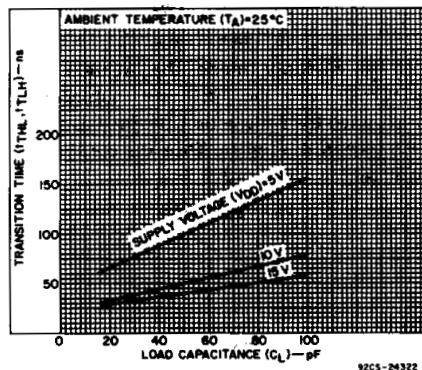

Fig. 7 — Typical transition time as a function of load capacitance.

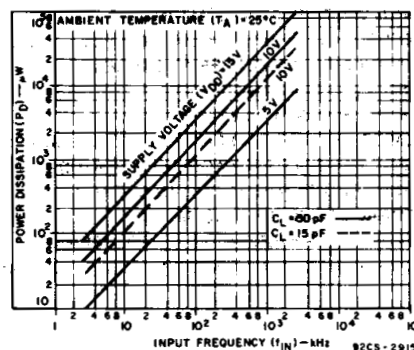

Fig. 8 — Typical dynamic power dissipation as a function of input frequency.

CD4089B Types

DYNAMIC ELECTRICAL CHARACTERISTICS at $T_A = 25^\circ\text{C}$;
 Input $t_r, t_f = 20 \text{ ns}$, $C_L = 50 \text{ pF}$, $R_L = 200 \text{ k}\Omega$

CHARACTERISTIC	TEST CONDITIONS	LIMITS			UNITS	
		V _{DD} V	Min.	Typ.		Max.
Propagation Delay Time, t_{PHL}, t_{PLH} Clock to $\overline{\text{Out}}$		5	—	110	220	ns
		10	—	55	110	
		15	—	45	90	
Clock or Strobe to Out		5	—	150	300	ns
		10	—	75	150	
		15	—	60	120	
Clock to Inhibit Out High Level to Low Level		5	—	360	720	ns
		10	—	160	320	
		15	—	110	220	
Low Level to High Level		5	—	250	500	ns
		10	—	100	200	
		15	—	75	150	
Clear to Out		5	—	380	760	ns
		10	—	175	350	
		15	—	130	260	
Clock to "9" or "15" Out		5	—	300	600	ns
		10	—	125	250	
		15	—	90	180	
Cascade to Out		5	—	90	180	ns
		10	—	45	90	
		15	—	35	70	
Inhibit In to Inhibit Out		5	—	160	320	ns
		10	—	75	150	
		15	—	55	110	
Set to Out		5	—	330	660	ns
		10	—	150	300	
		15	—	110	220	
Transition Time, t_{THL}, t_{TLH}		5	—	100	200	ns
		10	—	50	100	
		15	—	40	80	
Maximum Clock Frequency, f_{CL}		5	1.2	2.4	—	MHz
		10	2.5	5	—	
		15	3.5	7	—	
Minimum Clock Pulse Width, t_W		5	—	165	330	ns
		10	—	85	170	
		15	—	50	100	
Clock Rise or Fall Time, t_{rCL}, t_{fCL}		5	—	—	15	μs
		10	—	—	15	
		15	—	—	15	
Minimum Set or Clear Pulse Width, t_W		5	—	80	160	ns
		10	—	45	90	
		15	—	30	60	
Minimum Inhibit-In Setup Time, t_{SU}		5	—	50	100	ns
		10	—	20	40	
		15	—	10	20	
Minimum Inhibit In Removal Time, t_{REM}		5	—	120	240	ns
		10	—	65	130	
		15	—	55	110	

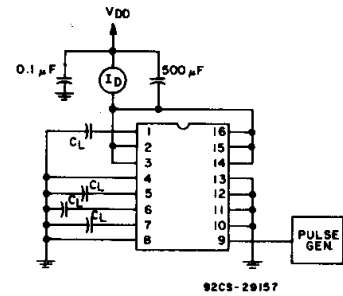

Fig. 9 – Dynamic power dissipation test circuit.

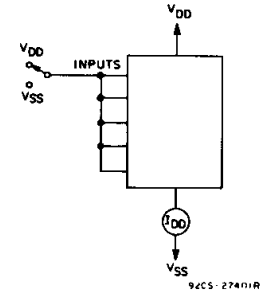

Fig. 10 – Quiescent device current test circuit.

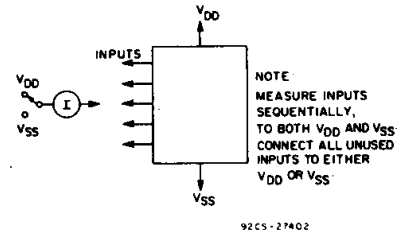

Fig. 11 – Input-current test circuit.

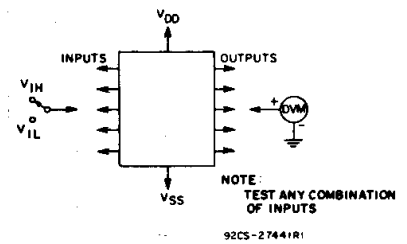
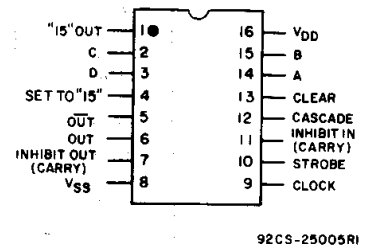

Fig. 12 – Input-voltage test circuit.



TOP VIEW
 TERMINAL ASSIGNMENT

3
 COMMERCIAL CMOS
 HIGH VOLTAGE ICs

CD4089B Types

DYNAMIC ELECTRICAL CHARACTERISTICS at $T_A = 25^\circ\text{C}$ (cont'd)
 Input $t_r, t_f = 20 \text{ ns}$, $C_L = 50 \text{ pF}$, $R_L = 200 \text{ k}\Omega$

CHARACTERISTIC	TEST CONDITIONS	LIMITS				UNITS
		V_{DD} V				
			Min.	Typ.	Max.	
Minimum Set Removal Time, t_{REM}		5	—	75	150	ns
		10	—	40	80	
		15	—	25	50	
Minimum Clear Removal Time, t_{REM}		5	—	30	60	ns
		10	—	20	40	
		15	—	15	30	
Input Capacitance, C_{IN}	Any Input	—	—	5	7.5	pF

STATIC ELECTRICAL CHARACTERISTICS

CHARACTERISTIC	CONDITIONS			LIMITS AT INDICATED TEMPERATURES ($^\circ\text{C}$)							UNITS
							+25				
	V_O (V)	V_{IN} (V)	V_{DD} (V)	-55	-40	+85	+125	Min.	Typ.	Max.	
Quiescent Device Current, I_{DD} Max.	—	0,5	5	5	5	150	150	—	0.04	5	μA
	—	0,10	10	10	10	300	300	—	0.04	10	
	—	0,15	15	20	20	600	600	—	0.04	20	
	—	0,20	20	100	100	3000	3000	—	0.08	100	
Output Low (Sink) Current I_{OL} Min.	0.4	0,5	5	0.64	0.61	0.42	0.36	0.51	1	—	mA
	0.5	0,10	10	1.6	1.5	1.1	0.9	1.3	2.6	—	
	1.5	0,15	15	4.2	4	2.8	2.4	3.4	6.8	—	
Output High (Source) Current, I_{OH} Min.	4.6	0,5	5	-0.64	-0.61	-0.42	-0.36	-0.51	-1	—	mA
	2.5	0,5	5	-2	-1.8	-1.3	-1.15	-1.6	-3.2	—	
	9.5	0,10	10	-1.6	-1.5	-1.1	-0.9	-1.3	-2.6	—	
	13.5	0,15	15	-4.2	-4	-2.8	-2.4	-3.4	-6.8	—	
Output Voltage: Low-Level, V_{OL} Max.	—	0,5	5	0.05				—	0	0.05	V
	—	0,10	10	0.05				—	0	0.05	
	—	0,15	15	0.05				—	0	0.05	
Output Voltage: High-Level, V_{OH} Min.	—	0,5	5	4.95				4.95	5	—	V
	—	0,10	10	9.95				9.95	10	—	
	—	0,15	15	14.95				14.95	15	—	
Input Low Voltage V_{IL} Max.	0.5,4.5	—	5	1.5				—	—	1.5	V
	1.9	—	10	3				—	—	3	
	1.5,13.5	—	15	4				—	—	4	
Input High Voltage, V_{IH} Min.	0.5,4.5	—	5	3.5				3.5	—	—	V
	1.9	—	10	7				7	—	—	
	1.5,13.5	—	15	11				11	—	—	
Input Current I_{IN} Max.	—	0,18	18	± 0.1	± 0.1	± 1	± 1	—	$\pm 10^{-5}$	± 0.1	μA

CD4089B Types

TRUTH TABLE

INPUTS										OUTPUTS			
Number of Pulses or Input Logic Level (0 = Low; 1 = High; X = Don't Care)										Number of Pulses or Output Logic Level (L = Low; H = High)			
D	C	B	A	CLK	INH IN	STR	CAS	CLR	SET	OUT	$\overline{\text{OUT}}$	INH OUT	"15" OUT
0	0	0	0	16	0	0	0	0	0	L	H	1	1
0	0	0	1	16	0	0	0	0	0	1	1	1	1
0	0	1	0	16	0	0	0	0	0	2	2	1	1
0	0	1	1	16	0	0	0	0	0	3	3	1	1
0	1	0	0	16	0	0	0	0	0	4	4	1	1
0	1	0	1	16	0	0	0	0	0	5	5	1	1
0	1	1	0	16	0	0	0	0	0	6	6	1	1
0	1	1	1	16	0	0	0	0	0	7	7	1	1
1	0	0	0	16	0	0	0	0	0	8	8	1	1
1	0	0	1	16	0	0	0	0	0	9	9	1	1
1	0	1	0	16	0	0	0	0	0	10	10	1	1
1	0	1	1	16	0	0	0	0	0	11	11	1	1
1	1	0	0	16	0	0	0	0	0	12	12	1	1
1	1	0	1	16	0	0	0	0	0	13	13	1	1
1	1	1	0	16	0	0	0	0	0	14	14	1	1
1	1	1	1	16	0	0	0	0	0	15	15	1	1
X	X	X	X	16	1	0	0	0	0	†	†	H	†
X	X	X	X	16	0	1	0	0	0	L	H	1	1
X	X	X	X	16	0	0	1	0	0	H	*	1	1
1	X	X	X	16	0	0	0	1	0	16	16	H	L
0	X	X	X	16	0	0	0	1	0	L	H	H	L
X	X	X	X	16	0	0	0	X	1	L	H	L	H

* Output same as the first 16 lines of this truth table (depending on values of A, B, C, D).

† Depends on internal state of counter.

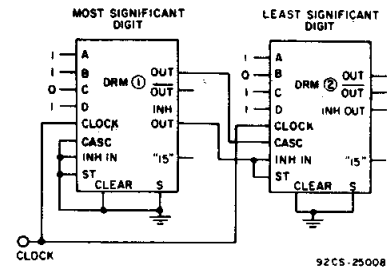

Fig. 13 - Two CD4089B's cascaded in the "Add" mode with a preset number

$$\text{of } 189 \left(\frac{11}{16} + \frac{13}{256} = \frac{189}{256} \right)$$

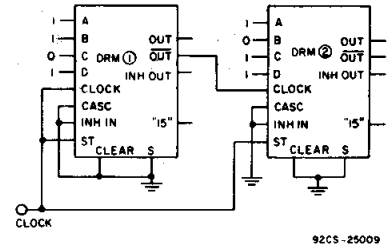
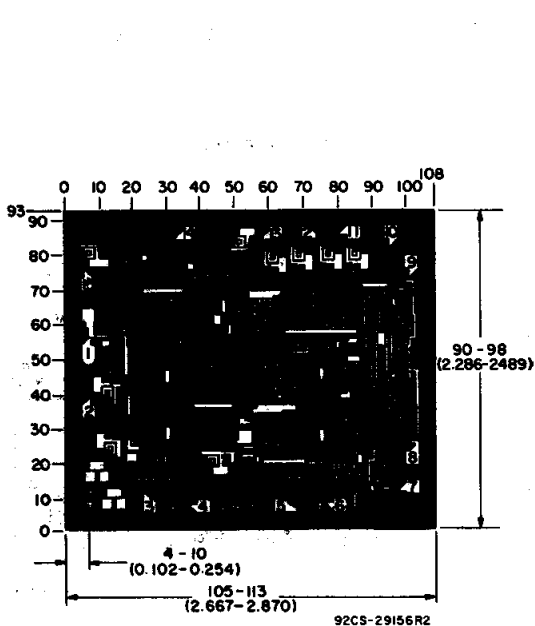

Fig. 14 - Two CD4089B's cascaded in the "Multiply" mode with a preset number

$$\text{of } 143 \left(\frac{11}{16} \times \frac{13}{256} = \frac{143}{256} \right)$$

COMMERCIAL CMOS HIGH VOLTAGE ICs



Dimensions and Pad Layout for CD4089BH

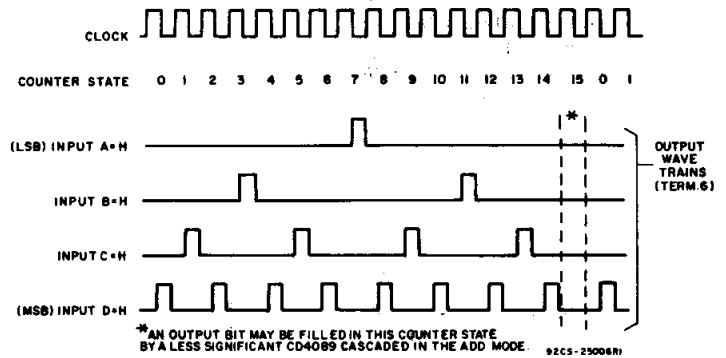

Fig. 15 - Timing diagram.

Dimensions in parentheses are in millimeters and are derived from the basic inch dimensions as indicated. Grid graduations are in mils (10^{-3} inch).

PACKAGING INFORMATION

Orderable Device	Status ⁽¹⁾	Package Type	Package Drawing	Pins	Package Qty	Eco Plan ⁽²⁾	Lead/Ball Finish	MSL Peak Temp ⁽³⁾
CD4089BE	ACTIVE	PDIP	N	16	25	Pb-Free (RoHS)	CU NIPDAU	N / A for Pkg Type
CD4089BEE4	ACTIVE	PDIP	N	16	25	Pb-Free (RoHS)	CU NIPDAU	N / A for Pkg Type
CD4089BF3A	ACTIVE	CDIP	J	16	1	TBD	A42	N / A for Pkg Type
CD4089BNSR	ACTIVE	SO	NS	16	2000	Green (RoHS & no Sb/Br)	CU NIPDAU	Level-1-260C-UNLIM
CD4089BNSRE4	ACTIVE	SO	NS	16	2000	Green (RoHS & no Sb/Br)	CU NIPDAU	Level-1-260C-UNLIM
CD4089BNSRG4	ACTIVE	SO	NS	16	2000	Green (RoHS & no Sb/Br)	CU NIPDAU	Level-1-260C-UNLIM
CD4089BPWR	ACTIVE	TSSOP	PW	16	2000	Green (RoHS & no Sb/Br)	CU NIPDAU	Level-1-260C-UNLIM
CD4089BPWRE4	ACTIVE	TSSOP	PW	16	2000	Green (RoHS & no Sb/Br)	CU NIPDAU	Level-1-260C-UNLIM
CD4089BPWRG4	ACTIVE	TSSOP	PW	16	2000	Green (RoHS & no Sb/Br)	CU NIPDAU	Level-1-260C-UNLIM

⁽¹⁾ The marketing status values are defined as follows:

ACTIVE: Product device recommended for new designs.

LIFEBUY: TI has announced that the device will be discontinued, and a lifetime-buy period is in effect.

NRND: Not recommended for new designs. Device is in production to support existing customers, but TI does not recommend using this part in a new design.

PREVIEW: Device has been announced but is not in production. Samples may or may not be available.

OBSELETE: TI has discontinued the production of the device.

⁽²⁾ Eco Plan - The planned eco-friendly classification: Pb-Free (RoHS), Pb-Free (RoHS Exempt), or Green (RoHS & no Sb/Br) - please check <http://www.ti.com/productcontent> for the latest availability information and additional product content details.

TBD: The Pb-Free/Green conversion plan has not been defined.

Pb-Free (RoHS): TI's terms "Lead-Free" or "Pb-Free" mean semiconductor products that are compatible with the current RoHS requirements for all 6 substances, including the requirement that lead not exceed 0.1% by weight in homogeneous materials. Where designed to be soldered at high temperatures, TI Pb-Free products are suitable for use in specified lead-free processes.

Pb-Free (RoHS Exempt): This component has a RoHS exemption for either 1) lead-based flip-chip solder bumps used between the die and package, or 2) lead-based die adhesive used between the die and leadframe. The component is otherwise considered Pb-Free (RoHS compatible) as defined above.

Green (RoHS & no Sb/Br): TI defines "Green" to mean Pb-Free (RoHS compatible), and free of Bromine (Br) and Antimony (Sb) based flame retardants (Br or Sb do not exceed 0.1% by weight in homogeneous material)

⁽³⁾ MSL, Peak Temp. -- The Moisture Sensitivity Level rating according to the JEDEC industry standard classifications, and peak solder temperature.

Important Information and Disclaimer:The information provided on this page represents TI's knowledge and belief as of the date that it is provided. TI bases its knowledge and belief on information provided by third parties, and makes no representation or warranty as to the accuracy of such information. Efforts are underway to better integrate information from third parties. TI has taken and continues to take reasonable steps to provide representative and accurate information but may not have conducted destructive testing or chemical analysis on incoming materials and chemicals. TI and TI suppliers consider certain information to be proprietary, and thus CAS numbers and other limited information may not be available for release.

In no event shall TI's liability arising out of such information exceed the total purchase price of the TI part(s) at issue in this document sold by TI to Customer on an annual basis.

TAPE AND REEL INFORMATION
REEL DIMENSIONS

TAPE DIMENSIONS

A0	Dimension designed to accommodate the component width
B0	Dimension designed to accommodate the component length
K0	Dimension designed to accommodate the component thickness
W	Overall width of the carrier tape
P1	Pitch between successive cavity centers

TAPE AND REEL INFORMATION

*All dimensions are nominal

Device	Package Type	Package Drawing	Pins	SPQ	Reel Diameter (mm)	Reel Width W1 (mm)	A0 (mm)	B0 (mm)	K0 (mm)	P1 (mm)	W (mm)	Pin1 Quadrant
CD4089BNSR	SO	NS	16	2000	330.0	16.4	8.2	10.5	2.5	12.0	16.0	Q1
CD4089BPWR	TSSOP	PW	16	2000	330.0	12.4	6.9	5.6	1.6	8.0	12.0	Q1

TAPE AND REEL BOX DIMENSIONS

*All dimensions are nominal

Device	Package Type	Package Drawing	Pins	SPQ	Length (mm)	Width (mm)	Height (mm)
CD4089BNSR	SO	NS	16	2000	367.0	367.0	38.0
CD4089BPWR	TSSOP	PW	16	2000	367.0	367.0	35.0

J (R-GDIP-T**)

14 LEADS SHOWN

CERAMIC DUAL IN-LINE PACKAGE



DIM \ PINS **	14	16	18	20
A	0.300 (7,62) BSC	0.300 (7,62) BSC	0.300 (7,62) BSC	0.300 (7,62) BSC
B MAX	0.785 (19,94)	.840 (21,34)	0.960 (24,38)	1.060 (26,92)
B MIN	—	—	—	—
C MAX	0.300 (7,62)	0.300 (7,62)	0.310 (7,87)	0.300 (7,62)
C MIN	0.245 (6,22)	0.245 (6,22)	0.220 (5,59)	0.245 (6,22)



4040083/F 03/03

- NOTES:
- All linear dimensions are in inches (millimeters).
 - This drawing is subject to change without notice.
 - This package is hermetically sealed with a ceramic lid using glass frit.
 - Index point is provided on cap for terminal identification only on press ceramic glass frit seal only.
 - Falls within MIL STD 1835 GDIP1-T14, GDIP1-T16, GDIP1-T18 and GDIP1-T20.

N (R-PDIP-T**)

PLASTIC DUAL-IN-LINE PACKAGE

16 PINS SHOWN



- NOTES:
- A. All linear dimensions are in inches (millimeters).
 - B. This drawing is subject to change without notice.
 - Falls within JEDEC MS-001, except 18 and 20 pin minimum body length (Dim A).
 - The 20 pin end lead shoulder width is a vendor option, either half or full width.

PW (R-PDSO-G16)

PLASTIC SMALL OUTLINE



4040064-4/G 02/11

- NOTES:
- A. All linear dimensions are in millimeters. Dimensioning and tolerancing per ASME Y14.5M-1994.
 - B. This drawing is subject to change without notice.
 - C. Body length does not include mold flash, protrusions, or gate burrs. Mold flash, protrusions, or gate burrs shall not exceed 0,15 each side.
 - D. Body width does not include interlead flash. Interlead flash shall not exceed 0,25 each side.
 - E. Falls within JEDEC MO-153

PW (R-PDSO-G16)

PLASTIC SMALL OUTLINE

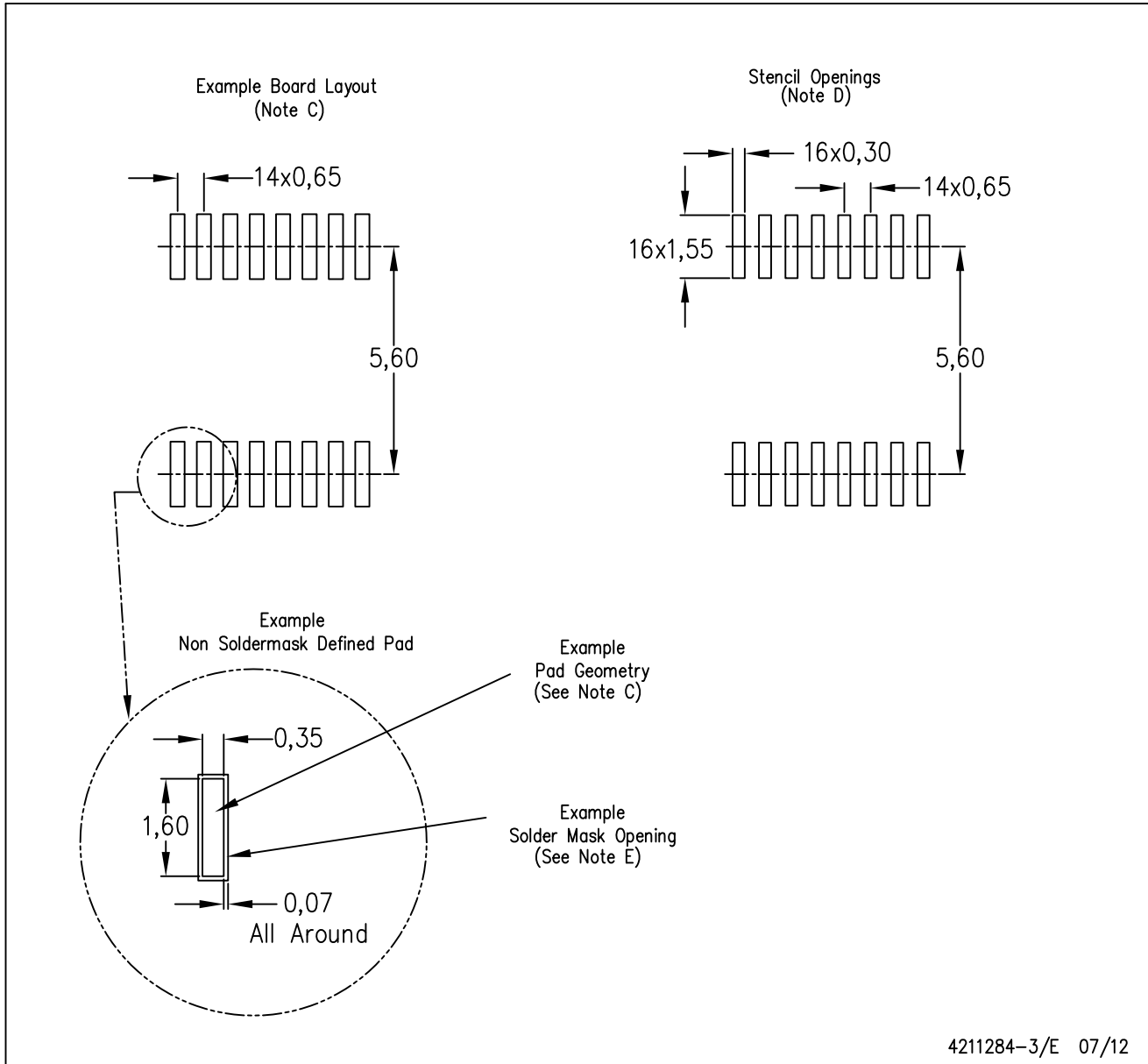

- NOTES:
- All linear dimensions are in millimeters.
 - This drawing is subject to change without notice.
 - Publication IPC-7351 is recommended for alternate designs.
 - Laser cutting apertures with trapezoidal walls and also rounding corners will offer better paste release. Customers should contact their board assembly site for stencil design recommendations. Refer to IPC-7525 for other stencil recommendations.
 - Customers should contact their board fabrication site for solder mask tolerances between and around signal pads.

MECHANICAL DATA

NS (R-PDSO-G**)

PLASTIC SMALL-OUTLINE PACKAGE

14-PINS SHOWN



- NOTES:
- A. All linear dimensions are in millimeters.
 - B. This drawing is subject to change without notice.
 - C. Body dimensions do not include mold flash or protrusion, not to exceed 0,15.

IMPORTANT NOTICE

Texas Instruments Incorporated and its subsidiaries (TI) reserve the right to make corrections, enhancements, improvements and other changes to its semiconductor products and services per JESD46C and to discontinue any product or service per JESD48B. Buyers should obtain the latest relevant information before placing orders and should verify that such information is current and complete. All semiconductor products (also referred to herein as "components") are sold subject to TI's terms and conditions of sale supplied at the time of order acknowledgment.

TI warrants performance of its components to the specifications applicable at the time of sale, in accordance with the warranty in TI's terms and conditions of sale of semiconductor products. Testing and other quality control techniques are used to the extent TI deems necessary to support this warranty. Except where mandated by applicable law, testing of all parameters of each component is not necessarily performed.

TI assumes no liability for applications assistance or the design of Buyers' products. Buyers are responsible for their products and applications using TI components. To minimize the risks associated with Buyers' products and applications, Buyers should provide adequate design and operating safeguards.

TI does not warrant or represent that any license, either express or implied, is granted under any patent right, copyright, mask work right, or other intellectual property right relating to any combination, machine, or process in which TI components or services are used. Information published by TI regarding third-party products or services does not constitute a license to use such products or services or a warranty or endorsement thereof. Use of such information may require a license from a third party under the patents or other intellectual property of the third party, or a license from TI under the patents or other intellectual property of TI.

Reproduction of significant portions of TI information in TI data books or data sheets is permissible only if reproduction is without alteration and is accompanied by all associated warranties, conditions, limitations, and notices. TI is not responsible or liable for such altered documentation. Information of third parties may be subject to additional restrictions.

Resale of TI components or services with statements different from or beyond the parameters stated by TI for that component or service voids all express and any implied warranties for the associated TI component or service and is an unfair and deceptive business practice. TI is not responsible or liable for any such statements.

Buyer acknowledges and agrees that it is solely responsible for compliance with all legal, regulatory and safety-related requirements concerning its products, and any use of TI components in its applications, notwithstanding any applications-related information or support that may be provided by TI. Buyer represents and agrees that it has all the necessary expertise to create and implement safeguards which anticipate dangerous consequences of failures, monitor failures and their consequences, lessen the likelihood of failures that might cause harm and take appropriate remedial actions. Buyer will fully indemnify TI and its representatives against any damages arising out of the use of any TI components in safety-critical applications.

In some cases, TI components may be promoted specifically to facilitate safety-related applications. With such components, TI's goal is to help enable customers to design and create their own end-product solutions that meet applicable functional safety standards and requirements. Nonetheless, such components are subject to these terms.

No TI components are authorized for use in FDA Class III (or similar life-critical medical equipment) unless authorized officers of the parties have executed a special agreement specifically governing such use.

Only those TI components which TI has specifically designated as military grade or "enhanced plastic" are designed and intended for use in military/aerospace applications or environments. Buyer acknowledges and agrees that any military or aerospace use of TI components which have **not** been so designated is solely at the Buyer's risk, and that Buyer is solely responsible for compliance with all legal and regulatory requirements in connection with such use.

TI has specifically designated certain components which meet ISO/TS16949 requirements, mainly for automotive use. Components which have not been so designated are neither designed nor intended for automotive use; and TI will not be responsible for any failure of such components to meet such requirements.

Products

Audio	www.ti.com/audio
Amplifiers	amplifier.ti.com
Data Converters	dataconverter.ti.com
DLP® Products	www.dlp.com
DSP	dsp.ti.com
Clocks and Timers	www.ti.com/clocks
Interface	interface.ti.com
Logic	logic.ti.com
Power Mgmt	power.ti.com
Microcontrollers	microcontroller.ti.com
RFID	www.ti-rfid.com
OMAP Mobile Processors	www.ti.com/omap
Wireless Connectivity	www.ti.com/wirelessconnectivity

Applications

Automotive and Transportation	www.ti.com/automotive
Communications and Telecom	www.ti.com/communications
Computers and Peripherals	www.ti.com/computers
Consumer Electronics	www.ti.com/consumer-apps
Energy and Lighting	www.ti.com/energy
Industrial	www.ti.com/industrial
Medical	www.ti.com/medical
Security	www.ti.com/security
Space, Avionics and Defense	www.ti.com/space-avionics-defense
Video and Imaging	www.ti.com/video

TI E2E Community e2e.ti.com