



! To Be Discontinued
Last time buy: September 30, 2018

**Relay for control panel of
1A to 10A (1c/2c/3c/4c)**

HC RELAYS



Standard type



Amber sealed type



With diode type

RoHS compliant

FEATURES

1. Standard type and Amber sealed type
2. Rich lineup includes relays with operating indication, with diode
3. Full range of types
Plug-in type, PC board type and TM type
4. Sockets and terminal sockets are available.

TYPICAL APPLICATIONS

1. Factory automation equipment and automotive devices
2. Control panels, power supply equipment, molding equipment, machine tools, welding equipment, agricultural equipment, etc.
3. Office equipment, automatic vending machines, telecommunications equipment, disaster prevention equipment, copiers, measuring devices, medical equipment, amusement devices, etc.
4. All types of household appliance

Protective construction: Dust cover type/
Sealed type

ORDERING INFORMATION

Standard type

HC - - -

Contact arrangement

- 1: 1 Form C
- 2: 2 Form C
- 3: 3 Form C
- 4: 4 Form C
- 4D: Bifurcated contact (twin)

Terminal arrangement

- H: Plug-in type
- HL: Plug-in with LED indication
- HP: PC board type
- HPL: PC board with LED indication
- HTM: TM type

Nominal coil voltage

- AC: 6, 12, 24, 48, 100 (100/110), 120 (110/120), 200 (200/220), 240 (220/240) V
- DC: 6, 12, 24, 48, 100 (100/110) V

Contact material

Contact arrangement	Contact material	AgSnO ₂ type	AgNi type
1 Form C		F	
2 Form C		F	
3 Form C		F	
4 Form C			Nil
4-pole bifurcated (twin)			Nil

Amber sealed type

HC - - -

Contact arrangement

- 1: 1 Form C
- 2: 2 Form C
- 4: 4 Form C

E: Amber sealed type

ED: Amber sealed type bifurcated contact (twin) (Only 4 Form C)

Terminal arrangement

- H: Plug-in type
- L: Plug-in with LED indication
- HP: PC board type
- PL: PC board with LED indication
- HTM: TM type

Nominal coil voltage

- AC: 6, 12, 24, 48, 100 (100/110), 120 (110/120), 200 (200/220), 240 (220/240) V
- DC: 6, 12, 24, 48, 100 (100/110) V

Contact material

Contact arrangement	Contact material	AgSnO ₂ type	AgNi type
1 Form C		F	
2 Form C		F	
4 Form C			Nil
4-pole bifurcated (twin)			Nil

With diode type (For DC)

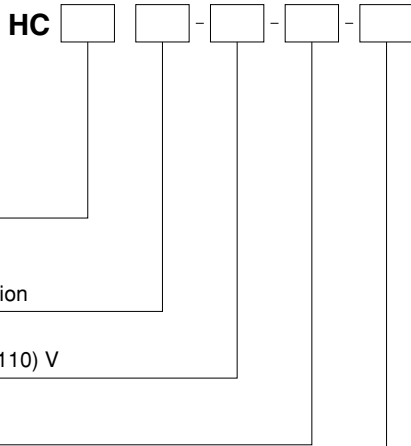

Contact arrangement

- 1: 1 Form C
- 2: 2 Form C
- 3: 3 Form C
- 4: 4 Form C
- 4D: Bifurcated contact (twin)

Terminal arrangement

- Nil: Plug-in type
- L: Plug-in with LED indication

Nominal coil voltage

DC: 6, 12, 24, 48, 100 (100/110) V

Surge suppression

D: With diode

Contact material

Contact arrangement	Contact material	AgSnO ₂ type	AgNi type
1 Form C		F	
2 Form C		F	
3 Form C		F	
4 Form C			Nil
4-pole bifurcated (twin)			Nil

LINEUP

Type	Contact arrangement	 Plug-in terminal type		 PC board terminal type		 Top mounting type (TM type)	Remarks
		Without LED	With LED	Without LED	With LED		
		HC relay Standard type	Single side stable	1 Form C	A		
2 Form C	A			A	A	A	
3 Form C	A			A	A	A	
4 Form C	A			A	A	A	
Bifurcated (Twin)	4 Form C		A	A	A	A	
HC relay Amber sealed type	Single side stable	1 Form C	A	A	A	A	
		2 Form C	A	A	A	A	
		4 Form C	A	A	A	A	
	Bifurcated (Twin)	4 Form C	A	A	A	A	
DC type with surge absorbing diode	Single side stable	1 Form C	A	A	—	—	Amber sealed type also available
		2 Form C	A	A	—	—	
		3 Form C	A	A	—	—	
		4 Form C	A	A	—	—	
	Bifurcated (Twin)	4 Form C	A	A	—	—	

A: Available
 Notes: 1. HC relays with ground terminals also available.
 2. HC relays with 0.9 mm wide PC board terminals also available.

HC RELAY CONTACT ARRANGEMENT

Type	Single side stable contact	4-pole bifurcated (twin) contact
Part number	HC□	HC4D
Features	Suitable for high-capacity load switching Standard type HC relays have high single-contact capacity; 1 Form C: 10 A 2 Form C and 3 Form C: 7 A 4 Form C: 5 A	Bifurcated (twin) contact ensures high contact reliability Suitable for low level loads Minimum switching capability: 100 μA 100m V DC (reference value)

LED INDICATION TYPE

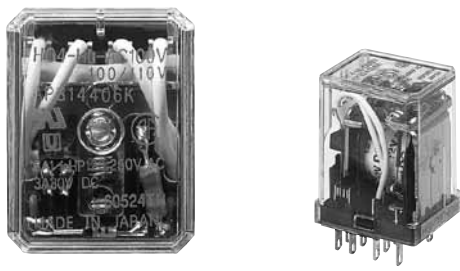
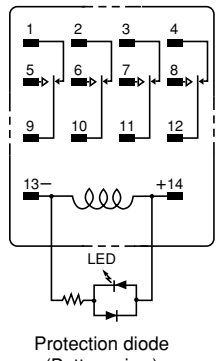
Type	With LED indication type	
Part number	HC□-HL	
Features	LED lights up when relay is operating Inspection and detection of trouble is easy. LEDs are green for DC types and red for AC types. All types are available with LED indication.	 <p>• LED colors indicate the type of relay: red for AC type and green for DC type.</p>  <p>Protection diode (Bottom view)</p>

HC RELAY SERIES PRODUCT TYPES

Type	Amber sealed type HC relay	HC relay with diode type (for DC)
Part number	HC□E	HC□-□-□V-D
Features	Relay is completely sealed with resin. Provides high reliability in adverse surroundings. Suitable for use in dusty conditions or where organic gases are present	Has built-in diode to absorb surge when the coil goes to the off state (for DC type). Suitable for protecting relay driver circuits and for noise suppression Diode characteristics: Reverse breakdown voltage 1,000 V Forward current 1 A

4-pole bifurcated (twin) type and Relay with LED indication are available.

TYPES

1. Standard type

1) Plug-in type

Nominal coil voltage	1 Form C	2 Form C	3 Form C	4 Form C	4 Form C (twin)
	Part No.	Part No.	Part No.	Part No.	Part No.
6V AC	HC1-H-AC6V-F	HC2-H-AC6V-F	HC3-H-AC6V-F	HC4-H-AC6V	HC4D-H-AC6V
12V AC	HC1-H-AC12V-F	HC2-H-AC12V-F	HC3-H-AC12V-F	HC4-H-AC12V	HC4D-H-AC12V
24V AC	HC1-H-AC24V-F	HC2-H-AC24V-F	HC3-H-AC24V-F	HC4-H-AC24V	HC4D-H-AC24V
48V AC	HC1-H-AC48V-F	HC2-H-AC48V-F	HC3-H-AC48V-F	HC4-H-AC48V	HC4D-H-AC48V
100/110V AC	HC1-H-AC100V-F	HC2-H-AC100V-F	HC3-H-AC100V-F	HC4-H-AC100V	HC4D-H-AC100V
110/120V AC	HC1-H-AC120V-F	HC2-H-AC120V-F	HC3-H-AC120V-F	HC4-H-AC120V	HC4D-H-AC120V
200/220V AC	HC1-H-AC200V-F	HC2-H-AC200V-F	HC3-H-AC200V-F	HC4-H-AC200V	HC4D-H-AC200V
220/240V AC	HC1-H-AC240V-F	HC2-H-AC240V-F	HC3-H-AC240V-F	HC4-H-AC240V	HC4D-H-AC240V
6V DC	HC1-H-DC6V-F	HC2-H-DC6V-F	HC3-H-DC6V-F	HC4-H-DC6V	HC4D-H-DC6V
12V DC	HC1-H-DC12V-F	HC2-H-DC12V-F	HC3-H-DC12V-F	HC4-H-DC12V	HC4D-H-DC12V
24V DC	HC1-H-DC24V-F	HC2-H-DC24V-F	HC3-H-DC24V-F	HC4-H-DC24V	HC4D-H-DC24V
48V DC	HC1-H-DC48V-F	HC2-H-DC48V-F	HC3-H-DC48V-F	HC4-H-DC48V	HC4D-H-DC48V
100/110V DC	HC1-H-DC100V-F	HC2-H-DC100V-F	HC3-H-DC100V-F	HC4-H-DC100V	HC4D-H-DC100V

Standard packing: Carton: 20 pcs.; Case: 200 pcs.

2) Plug-in type (with LED indication)

Nominal coil voltage	1 Form C	2 Form C	3 Form C	4 Form C	4 Form C (twin)
	Part No.	Part No.	Part No.	Part No.	Part No.
6V AC	HC1-HL-AC6V-F	HC2-HL-AC6V-F	HC3-HL-AC6V-F	HC4-HL-AC6V	HC4D-HL-AC6V
12V AC	HC1-HL-AC12V-F	HC2-HL-AC12V-F	HC3-HL-AC12V-F	HC4-HL-AC12V	HC4D-HL-AC12V
24V AC	HC1-HL-AC24V-F	HC2-HL-AC24V-F	HC3-HL-AC24V-F	HC4-HL-AC24V	HC4D-HL-AC24V
100/110V AC	HC1-HL-AC100V-F	HC2-HL-AC100V-F	HC3-HL-AC100V-F	HC4-HL-AC100V	HC4D-HL-AC100V
110/120V AC	HC1-HL-AC120V-F	HC2-HL-AC120V-F	HC3-HL-AC120V-F	HC4-HL-AC120V	HC4D-HL-AC120V
200/220V AC	HC1-HL-AC200V-F	HC2-HL-AC200V-F	HC3-HL-AC200V-F	HC4-HL-AC200V	HC4D-HL-AC200V
220/240V AC	HC1-HL-AC240V-F	HC2-HL-AC240V-F	HC3-HL-AC240V-F	HC4-HL-AC240V	HC4D-HL-AC240V
6V DC	HC1-HL-DC6V-F	HC2-HL-DC6V-F	HC3-HL-DC6V-F	HC4-HL-DC6V	HC4D-HL-DC6V
12V DC	HC1-HL-DC12V-F	HC2-HL-DC12V-F	HC3-HL-DC12V-F	HC4-HL-DC12V	HC4D-HL-DC12V
24V DC	HC1-HL-DC24V-F	HC2-HL-DC24V-F	HC3-HL-DC24V-F	HC4-HL-DC24V	HC4D-HL-DC24V
48V DC	HC1-HL-DC48V-F	HC2-HL-DC48V-F	HC3-HL-DC48V-F	HC4-HL-DC48V	HC4D-HL-DC48V
100/110V DC	HC1-HL-DC100V-F	HC2-HL-DC100V-F	HC3-HL-DC100V-F	HC4-HL-DC100V	HC4D-HL-DC100V

Standard packing: Carton: 20 pcs.; Case: 200 pcs.

3) PC board type

Nominal coil voltage	1 Form C	2 Form C	3 Form C	4 Form C	4 Form C (twin)
	Part No.	Part No.	Part No.	Part No.	Part No.
6V AC	HC1-HP-AC6V-F	HC2-HP-AC6V-F	HC3-HP-AC6V-F	HC4-HP-AC6V	HC4D-HP-AC6V
12V AC	HC1-HP-AC12V-F	HC2-HP-AC12V-F	HC3-HP-AC12V-F	HC4-HP-AC12V	HC4D-HP-AC12V
24V AC	HC1-HP-AC24V-F	HC2-HP-AC24V-F	HC3-HP-AC24V-F	HC4-HP-AC24V	HC4D-HP-AC24V
48V AC	HC1-HP-AC48V-F	HC2-HP-AC48V-F	HC3-HP-AC48V-F	HC4-HP-AC48V	HC4D-HP-AC48V
100/110V AC	HC1-HP-AC100V-F	HC2-HP-AC100V-F	HC3-HP-AC100V-F	HC4-HP-AC100V	HC4D-HP-AC100V
110/120V AC	HC1-HP-AC120V-F	HC2-HP-AC120V-F	HC3-HP-AC120V-F	HC4-HP-AC120V	HC4D-HP-AC120V
200/220V AC	HC1-HP-AC200V-F	HC2-HP-AC200V-F	HC3-HP-AC200V-F	HC4-HP-AC200V	HC4D-HP-AC200V
220/240V AC	HC1-HP-AC240V-F	HC2-HP-AC240V-F	HC3-HP-AC240V-F	HC4-HP-AC240V	HC4D-HP-AC240V
6V DC	HC1-HP-DC6V-F	HC2-HP-DC6V-F	HC3-HP-DC6V-F	HC4-HP-DC6V	HC4D-HP-DC6V
12V DC	HC1-HP-DC12V-F	HC2-HP-DC12V-F	HC3-HP-DC12V-F	HC4-HP-DC12V	HC4D-HP-DC12V
24V DC	HC1-HP-DC24V-F	HC2-HP-DC24V-F	HC3-HP-DC24V-F	HC4-HP-DC24V	HC4D-HP-DC24V
48V DC	HC1-HP-DC48V-F	HC2-HP-DC48V-F	HC3-HP-DC48V-F	HC4-HP-DC48V	HC4D-HP-DC48V
100/110V DC	HC1-HP-DC100V-F	HC2-HP-DC100V-F	HC3-HP-DC100V-F	HC4-HP-DC100V	HC4D-HP-DC100V

Standard packing: Carton: 20 pcs.; Case: 200 pcs.

Note: Please add "-31" before "-F" in the part number when ordering the PC board type 0.9 mm width terminal (ex) HC1-HP-AC6V-31-F.

4) PC board type (with LED indication)

Nominal coil voltage	1 Form C	2 Form C	3 Form C	4 Form C	4 Form C (twin)
	Part No.	Part No.	Part No.	Part No.	Part No.
6V AC	HC1-HPL-AC6V-F	HC2-HPL-AC6V-F	HC3-HPL-AC6V-F	HC4-HPL-AC6V	HC4D-HPL-AC6V
12V AC	HC1-HPL-AC12V-F	HC2-HPL-AC12V-F	HC3-HPL-AC12V-F	HC4-HPL-AC12V	HC4D-HPL-AC12V
24V AC	HC1-HPL-AC24V-F	HC2-HPL-AC24V-F	HC3-HPL-AC24V-F	HC4-HPL-AC24V	HC4D-HPL-AC24V
100/110V AC	HC1-HPL-AC100V-F	HC2-HPL-AC100V-F	HC3-HPL-AC100V-F	HC4-HPL-AC100V	HC4D-HPL-AC100V
110/120V AC	HC1-HPL-AC120V-F	HC2-HPL-AC120V-F	HC3-HPL-AC120V-F	HC4-HPL-AC120V	HC4D-HPL-AC120V
200/220V AC	HC1-HPL-AC200V-F	HC2-HPL-AC200V-F	HC3-HPL-AC200V-F	HC4-HPL-AC200V	HC4D-HPL-AC200V
6V DC	HC1-HPL-DC6V-F	HC2-HPL-DC6V-F	HC3-HPL-DC6V-F	HC4-HPL-DC6V	HC4D-HPL-DC6V
12V DC	HC1-HPL-DC12V-F	HC2-HPL-DC12V-F	HC3-HPL-DC12V-F	HC4-HPL-DC12V	HC4D-HPL-DC12V
24V DC	HC1-HPL-DC24V-F	HC2-HPL-DC24V-F	HC3-HPL-DC24V-F	HC4-HPL-DC24V	HC4D-HPL-DC24V
48V DC	HC1-HPL-DC48V-F	HC2-HPL-DC48V-F	HC3-HPL-DC48V-F	HC4-HPL-DC48V	HC4D-HPL-DC48V
100/110V DC	HC1-HPL-DC100V-F	HC2-HPL-DC100V-F	HC3-HPL-DC100V-F	HC4-HPL-DC100V	HC4D-HPL-DC100V

Standard packing: Carton: 20 pcs.; Case: 200 pcs.

Note: Please add "-31" before "-F" in the part number when ordering the PC board type 0.9 mm width terminal (ex) HC1-HPL-AC6V-31-F.

5) TM type

Nominal coil voltage	1 Form C	2 Form C	3 Form C	4 Form C	4 Form C (twin)
	Part No.	Part No.	Part No.	Part No.	Part No.
6V AC	HC1-HTM-AC6V-F	HC2-HTM-AC6V-F	HC3-HTM-AC6V-F	HC4-HTM-AC6V	HC4D-HTM-AC6V
12V AC	HC1-HTM-AC12V-F	HC2-HTM-AC12V-F	HC3-HTM-AC12V-F	HC4-HTM-AC12V	HC4D-HTM-AC12V
24V AC	HC1-HTM-AC24V-F	HC2-HTM-AC24V-F	HC3-HTM-AC24V-F	HC4-HTM-AC24V	HC4D-HTM-AC24V
48V AC	HC1-HTM-AC48V-F	HC2-HTM-AC48V-F	HC3-HTM-AC48V-F	HC4-HTM-AC48V	HC4D-HTM-AC48V
100/110V AC	HC1-HTM-AC100V-F	HC2-HTM-AC100V-F	HC3-HTM-AC100V-F	HC4-HTM-AC100V	HC4D-HTM-AC100V
110/120V AC	HC1-HTM-AC120V-F	HC2-HTM-AC120V-F	HC3-HTM-AC120V-F	HC4-HTM-AC120V	HC4D-HTM-AC120V
200/220V AC	HC1-HTM-AC200V-F	HC2-HTM-AC200V-F	HC3-HTM-AC200V-F	HC4-HTM-AC200V	HC4D-HTM-AC200V
6V DC	HC1-HTM-DC6V-F	HC2-HTM-DC6V-F	HC3-HTM-DC6V-F	HC4-HTM-DC6V	HC4D-HTM-DC6V
12V DC	HC1-HTM-DC12V-F	HC2-HTM-DC12V-F	HC3-HTM-DC12V-F	HC4-HTM-DC12V	HC4D-HTM-DC12V
24V DC	HC1-HTM-DC24V-F	HC2-HTM-DC24V-F	HC3-HTM-DC24V-F	HC4-HTM-DC24V	HC4D-HTM-DC24V
48V DC	HC1-HTM-DC48V-F	HC2-HTM-DC48V-F	HC3-HTM-DC48V-F	HC4-HTM-DC48V	HC4D-HTM-DC48V
100/110V DC	HC1-HTM-DC100V-F	HC2-HTM-DC100V-F	HC3-HTM-DC100V-F	HC4-HTM-DC100V	HC4D-HTM-DC100V

Standard packing: Carton: 20 pcs.; Case: 200 pcs.

2. Amber sealed type

1) Plug-in type

Nominal coil voltage	1 Form C	2 Form C	4 Form C	4 Form C (twin)
	Part No.	Part No.	Part No.	Part No.
6V AC	HC1E-H-AC6V-F	HC2E-H-AC6V-F	HC4E-H-AC6V	HC4ED-H-AC6V
12V AC	HC1E-H-AC12V-F	HC2E-H-AC12V-F	HC4E-H-AC12V	HC4ED-H-AC12V
24V AC	HC1E-H-AC24V-F	HC2E-H-AC24V-F	HC4E-H-AC24V	HC4ED-H-AC24V
48V AC	HC1E-H-AC48V-F	HC2E-H-AC48V-F	HC4E-H-AC48V	HC4ED-H-AC48V
100/110V AC	HC1E-H-AC100V-F	HC2E-H-AC100V-F	HC4E-H-AC100V	HC4ED-H-AC100V
110/120V AC	HC1E-H-AC120V-F	HC2E-H-AC120V-F	HC4E-H-AC120V	HC4ED-H-AC120V
200/220V AC	HC1E-H-AC200V-F	HC2E-H-AC200V-F	HC4E-H-AC200V	HC4ED-H-AC200V
220/240V AC	HC1E-H-AC240V-F	HC2E-H-AC240V-F	HC4E-H-AC240V	HC4ED-H-AC240V
6V DC	HC1E-H-DC6V-F	HC2E-H-DC6V-F	HC4E-H-DC6V	HC4ED-H-DC6V
12V DC	HC1E-H-DC12V-F	HC2E-H-DC12V-F	HC4E-H-DC12V	HC4ED-H-DC12V
24V DC	HC1E-H-DC24V-F	HC2E-H-DC24V-F	HC4E-H-DC24V	HC4ED-H-DC24V
48V DC	HC1E-H-DC48V-F	HC2E-H-DC48V-F	HC4E-H-DC48V	HC4ED-H-DC48V
100/110V DC	HC1E-H-DC100V-F	HC2E-H-DC100V-F	HC4E-H-DC100V	HC4ED-H-DC100V

Standard packing: Carton: 20 pcs.; Case: 200 pcs.

2) Plug-in type (With LED indication)

Nominal coil voltage	1 Form C	2 Form C	4 Form C	4 Form C (twin)
	Part No.	Part No.	Part No.	Part No.
6V AC	HC1E-L-AC6V-F	HC2E-L-AC6V-F	HC4E-L-AC6V	HC4ED-L-AC6V
12V AC	HC1E-L-AC12V-F	HC2E-L-AC12V-F	HC4E-L-AC12V	HC4ED-L-AC12V
24V AC	HC1E-L-AC24V-F	HC2E-L-AC24V-F	HC4E-L-AC24V	HC4ED-L-AC24V
48V AC	HC1E-L-AC48V-F	HC2E-L-AC48V-F	HC4E-L-AC48V	HC4ED-L-AC48V
100/110V AC	HC1E-L-AC100V-F	HC2E-L-AC100V-F	HC4E-L-AC100V	HC4ED-L-AC100V
110/120V AC	HC1E-L-AC120V-F	HC2E-L-AC120V-F	HC4E-L-AC120V	HC4ED-L-AC120V
200/220V AC	HC1E-L-AC200V-F	HC2E-L-AC200V-F	HC4E-L-AC200V	HC4ED-L-AC200V
220/240V AC	HC1E-L-AC240V-F	HC2E-L-AC240V-F	HC4E-L-AC240V	HC4ED-L-AC240V
6V DC	HC1E-L-DC6V-F	HC2E-L-DC6V-F	HC4E-L-DC6V	HC4ED-L-DC6V
12V DC	HC1E-L-DC12V-F	HC2E-L-DC12V-F	HC4E-L-DC12V	HC4ED-L-DC12V
24V DC	HC1E-L-DC24V-F	HC2E-L-DC24V-F	HC4E-L-DC24V	HC4ED-L-DC24V
48V DC	HC1E-L-DC48V-F	HC2E-L-DC48V-F	HC4E-L-DC48V	HC4ED-L-DC48V
100/110V DC	HC1E-L-DC100V-F	HC2E-L-DC100V-F	HC4E-L-DC100V	HC4ED-L-DC100V

Standard packing: Carton: 20 pcs.; Case: 200 pcs.

3) PC board type

Nominal coil voltage	1 Form C	2 Form C	4 Form C	4 Form C (twin)
	Part No.	Part No.	Part No.	Part No.
6V AC	HC1E-HP-AC6V-F	HC2E-HP-AC6V-F	HC4E-HP-AC6V	HC4ED-HP-AC6V
12V AC	HC1E-HP-AC12V-F	HC2E-HP-AC12V-F	HC4E-HP-AC12V	HC4ED-HP-AC12V
24V AC	HC1E-HP-AC24V-F	HC2E-HP-AC24V-F	HC4E-HP-AC24V	HC4ED-HP-AC24V
48V AC	HC1E-HP-AC48V-F	HC2E-HP-AC48V-F	HC4E-HP-AC48V	HC4ED-HP-AC48V
100/110V AC	HC1E-HP-AC100V-F	HC2E-HP-AC100V-F	HC4E-HP-AC100V	HC4ED-HP-AC100V
110/120V AC	HC1E-HP-AC120V-F	HC2E-HP-AC120V-F	HC4E-HP-AC120V	HC4ED-HP-AC120V
200/220V AC	HC1E-HP-AC200V-F	HC2E-HP-AC200V-F	HC4E-HP-AC200V	HC4ED-HP-AC200V
220/240V AC	HC1E-HP-AC240V-F	HC2E-HP-AC240V-F	HC4E-HP-AC240V	HC4ED-HP-AC240V
6V DC	HC1E-HP-DC6V-F	HC2E-HP-DC6V-F	HC4E-HP-DC6V	HC4ED-HP-DC6V
12V DC	HC1E-HP-DC12V-F	HC2E-HP-DC12V-F	HC4E-HP-DC12V	HC4ED-HP-DC12V
24V DC	HC1E-HP-DC24V-F	HC2E-HP-DC24V-F	HC4E-HP-DC24V	HC4ED-HP-DC24V
48V DC	HC1E-HP-DC48V-F	HC2E-HP-DC48V-F	HC4E-HP-DC48V	HC4ED-HP-DC48V
100/110V DC	HC1E-HP-DC100V-F	HC2E-HP-DC100V-F	HC4E-HP-DC100V	HC4ED-HP-DC100V

Standard packing: Carton: 20 pcs.; Case: 200 pcs.

Note: Please add "-31" in the suffix of part number when ordering the PC board type 0.9 mm width terminal. (4 Form C, 4 Form C (twin) only)

4) PC board type (With LED indication)

Nominal coil voltage	1 Form C	2 Form C	4 Form C	4 Form C (twin)
	Part No.	Part No.	Part No.	Part No.
6V AC	HC1E-PL-AC6V-F	HC2E-PL-AC6V-F	HC4E-PL-AC6V	HC4ED-PL-AC6V
12V AC	HC1E-PL-AC12V-F	HC2E-PL-AC12V-F	HC4E-PL-AC12V	HC4ED-PL-AC12V
24V AC	HC1E-PL-AC24V-F	HC2E-PL-AC24V-F	HC4E-PL-AC24V	HC4ED-PL-AC24V
48V AC	HC1E-PL-AC48V-F	HC2E-PL-AC48V-F	HC4E-PL-AC48V	HC4ED-PL-AC48V
100/110V AC	HC1E-PL-AC100V-F	HC2E-PL-AC100V-F	HC4E-PL-AC100V	HC4ED-PL-AC100V
110/120V AC	HC1E-PL-AC120V-F	HC2E-PL-AC120V-F	HC4E-PL-AC120V	HC4ED-PL-AC120V
200/220V AC	HC1E-PL-AC200V-F	HC2E-PL-AC200V-F	HC4E-PL-AC200V	HC4ED-PL-AC200V
220/240V AC	HC1E-PL-AC240V-F	HC2E-PL-AC240V-F	HC4E-PL-AC240V	HC4ED-PL-AC240V
6V DC	HC1E-PL-DC6V-F	HC2E-PL-DC6V-F	HC4E-PL-DC6V	HC4ED-PL-DC6V
12V DC	HC1E-PL-DC12V-F	HC2E-PL-DC12V-F	HC4E-PL-DC12V	HC4ED-PL-DC12V
24V DC	HC1E-PL-DC24V-F	HC2E-PL-DC24V-F	HC4E-PL-DC24V	HC4ED-PL-DC24V
48V DC	HC1E-PL-DC48V-F	HC2E-PL-DC48V-F	HC4E-PL-DC48V	HC4ED-PL-DC48V
100/110V DC	HC1E-PL-DC100V-F	HC2E-PL-DC100V-F	HC4E-PL-DC100V	HC4ED-PL-DC100V

Standard packing: Carton: 20 pcs.; Case: 200 pcs.

Note: Please add "-31" in the suffix of part number when ordering the PC board type 0.9 mm width terminal. (4 Form C, 4 Form C (twin) only)

5) TM type

Nominal coil voltage	1 Form C	2 Form C	4 Form C	4 Form C (twin)
	Part No.	Part No.	Part No.	Part No.
6V AC	HC1E-HTM-AC6V-F	HC2E-HTM-AC6V-F	HC4E-HTM-AC6V	HC4ED-HTM-AC6V
12V AC	HC1E-HTM-AC12V-F	HC2E-HTM-AC12V-F	HC4E-HTM-AC12V	HC4ED-HTM-AC12V
24V AC	HC1E-HTM-AC24V-F	HC2E-HTM-AC24V-F	HC4E-HTM-AC24V	HC4ED-HTM-AC24V
48V AC	HC1E-HTM-AC48V-F	HC2E-HTM-AC48V-F	HC4E-HTM-AC48V	HC4ED-HTM-AC48V
100/110V AC	HC1E-HTM-AC100V-F	HC2E-HTM-AC100V-F	HC4E-HTM-AC100V	HC4ED-HTM-AC100V
110/120V AC	HC1E-HTM-AC120V-F	HC2E-HTM-AC120V-F	HC4E-HTM-AC120V	HC4ED-HTM-AC120V
200/220V AC	HC1E-HTM-AC200V-F	HC2E-HTM-AC200V-F	HC4E-HTM-AC200V	HC4ED-HTM-AC200V
220/240V AC	HC1E-HTM-AC240V-F	HC2E-HTM-AC240V-F	HC4E-HTM-AC240V	HC4ED-HTM-AC240V
6V DC	HC1E-HTM-DC6V-F	HC2E-HTM-DC6V-F	HC4E-HTM-DC6V	HC4ED-HTM-DC6V
12V DC	HC1E-HTM-DC12V-F	HC2E-HTM-DC12V-F	HC4E-HTM-DC12V	HC4ED-HTM-DC12V
24V DC	HC1E-HTM-DC24V-F	HC2E-HTM-DC24V-F	HC4E-HTM-DC24V	HC4ED-HTM-DC24V
48V DC	HC1E-HTM-DC48V-F	HC2E-HTM-DC48V-F	HC4E-HTM-DC48V	HC4ED-HTM-DC48V
100/110V DC	HC1E-HTM-DC100V-F	HC2E-HTM-DC100V-F	HC4E-HTM-DC100V	HC4ED-HTM-DC100V

Standard packing: Carton: 20 pcs.; Case: 200 pcs.

4. With diode type (For DC)

1) Plug-in type

Nominal coil voltage	1 Form C	2 Form C	3 Form C	4 Form C	4 Form C (twin)
	Part No.	Part No.	Part No.	Part No.	Part No.
6V DC	HC1-DC6V-D-F	HC2-DC6V-D-F	HC3-DC6V-D-F	HC4-DC6V-D	HC4D-DC6V-D
12V DC	HC1-DC12V-D-F	HC2-DC12V-D-F	HC3-DC12V-D-F	HC4-DC12V-D	HC4D-DC12V-D
24V DC	HC1-DC24V-D-F	HC2-DC24V-D-F	HC3-DC24V-D-F	HC4-DC24V-D	HC4D-DC24V-D
48V DC	HC1-DC48V-D-F	HC2-DC48V-D-F	HC3-DC48V-D-F	HC4-DC48V-D	HC4D-DC48V-D
100/110V DC	HC1-DC100V-D-F	HC2-DC100V-D-F	HC3-DC100V-D-F	HC4-DC100V-D	HC4D-DC100V-D

Standard packing: Carton: 20 pcs.; Case: 200 pcs.

2) Plug-in type (with LED indication)

Nominal coil voltage	1 Form C	2 Form C	3 Form C	4 Form C	4 Form C (twin)
	Part No.	Part No.	Part No.	Part No.	Part No.
6V DC	HC1-L-DC6V-D-F	HC2-L-DC6V-D-F	HC3-L-DC6V-D-F	HC4-L-DC6V-D	HC4D-L-DC6V-D
12V DC	HC1-L-DC12V-D-F	HC2-L-DC12V-D-F	HC3-L-DC12V-D-F	HC4-L-DC12V-D	HC4D-L-DC12V-D
24V DC	HC1-L-DC24V-D-F	HC2-L-DC24V-D-F	HC3-L-DC24V-D-F	HC4-L-DC24V-D	HC4D-L-DC24V-D
48V DC	HC1-L-DC48V-D-F	HC2-L-DC48V-D-F	HC3-L-DC48V-D-F	HC4-L-DC48V-D	HC4D-L-DC48V-D
100/110V DC	HC1-L-DC100V-D-F	HC2-L-DC100V-D-F	HC3-L-DC100V-D-F	HC4-L-DC100V-D	HC4D-L-DC100V-D

Standard packing: Carton: 20 pcs.; Case: 200 pcs.

* Sockets and mounting boards available

RATING

1. Standard type

1) Coil data

(1) AC coils (50/60Hz)

Type	Nominal coil voltage	Pick-up voltage* (at 20°C 68°F)	Drop-out voltage* (at 20°C 68°F)	Nominal coil current [±20%] (at 20°C 68°F)		Coil inductance		Nominal operating power		Max. applied voltage (at 70°C 158°F)
				50Hz	60Hz	N.C. condition	N.O. condition	50Hz	60Hz	
Standard	6V AC	80%V or less of nominal voltage (Initial)	30%V or more of nominal voltage (Initial)	224mA	200mA	0.078H	0.074H	1.3VA	1.2VA	110%V of nominal voltage
	12V AC			111mA	100mA	0.312H	0.295H			
	24V AC			56mA	50mA	1.243H	1.181H			
	48V AC			28mA	25mA	4.974H	4.145H			
	100/110V AC			13.4/14.7mA	12/13.2mA	23.75H	20.63H			
	110/120V AC			12.2/13.5mA	10.9/11.9mA	27.19H	25.57H			
	200/220V AC			6.7/7.4mA	6/6.6mA	85.98H	81.76H			

* Square, pulse drive

Notes: 1. The relay operates in a range of 80% to 110% V of the voltage rating, but ideally, in consideration of temporary voltage fluctuations, it should be operated at the rated voltage. In particular, for AC operation, if the applied voltage drops to 80% V or more below the rated voltage, humming will occur and a large current will flow leading possibly to coil burnout.

2. The maximum applied voltage is the maximum voltage fluctuation value for the coil power supply. This value is not a permissible value for continuous operation. (This value differs depending on the ambient temperature. Please contact us for details.)

(2) DC coils

Type	Nominal coil voltage	Pick-up voltage* (at 20°C 68°F)	Drop-out voltage* (at 20°C 68°F)	Nominal coil current [±10%] (at 20°C 68°F)	Coil resistance [±10%] (at 20°C 68°F)	Nominal operating power	Max. applied voltage (at 70°C 158°F)
Standard	6V DC	80%V or less of nominal voltage (Initial)	10%V or more of nominal voltage (Initial)	150mA	40Ω	0.9W	110%V of nominal voltage
	12V DC			75mA	160Ω		
	24V DC			37mA	650Ω		
	48V DC			18.5mA	2,600Ω		
	100/110V DC			10/11mA	10,000Ω		

* Square, pulse drive

Notes: 1. The coil resistance for DC operation is the value measured when the coil temperature is 20°C 68°F. Compensate ±0.4% for every ±1°C change in temperature.

2. The relay operates in a range of 80% to 110% V of the voltage rating, but ideally, in consideration of temporary voltage fluctuations, it should be operated at the rated voltage.

3. For use with 200 V DC, connect a 10 KΩ (5W) resistor, in series, to the 100 V DC relay.

4. The maximum applied voltage is the maximum voltage fluctuation value for the coil power supply. This value is not a permissible value for continuous operation. (This value differs depending on the ambient temperature. Please contact us for details.)

2) Specifications

Characteristics		Item	Specifications				
Contact	Arrangement		1 Form C	2 Form C	3 Form C	4 Form C	4 Form C (twin)
	Contact resistance (Initial)		Max. 30 mΩ (By voltage drop 6 V DC 1A)				
	Contact material		Ag alloy (cd free) + Au flash			AgNi type + Au clad	
Rating	Nominal switching capacity (resistive load)		10A 250V AC	7A 250V AC	7A 250V AC	5A 250V AC	3A 250V AC
	Max. switching power (resistive load)		2,500VA	1,750VA	1,750VA	1,250VA	750VA
	Max. switching voltage		250VAC				
	Max. switching current*4		10A	7A	7A	5A	3A
	Min. switching capacity (Reference value)*1		1mA 1V DC				
Electrical characteristics	Insulation resistance (Initial)		Min. 1,000MΩ (at 500V DC) Measurement at same location as "Breakdown voltage" section.				
	Breakdown voltage (Initial)	Between open contacts	700 Vrms for 1min. (Detection current: 10mA.)				
		Between contact sets	700 Vrms for 1min. (Detection current: 10mA.)				
		Between contact and coil	2,000 Vrms for 1min. (Detection current: 10mA.)				
	Operate time (initial, at 20°C 68°F)*2		Max. 20ms (Nominal coil voltage applied to the coil, excluding contact bounce time.)				
	Release time (initial, at 20°C 68°F)*2		Max. 20ms (Nominal coil voltage applied to the coil, excluding contact bounce time.) (without diode)				
Mechanical characteristics	Shock resistance	Functional	Min. 196 m/s ² (Half-wave pulse of sine wave: 11 ms; detection time: 10μs.)				
		Destructive	Min. 980 m/s ² (Half-wave pulse of sine wave: 6 ms.)				
	Vibration resistance	Functional	10 to 55 Hz at double amplitude of 1 mm (Detection time: 10μs.)				
		Destructive	10 to 55 Hz at double amplitude of 2 mm				
Expected life	Mechanical		Min. 5×10 ⁷ : AC coil type (at 180 times/min.); Min. 10 ⁸ : DC coil type (at 180 times/min.)				
	Electrical		Min. 2×10 ⁵ resistive load (at 20 times/min.)	Min. 2×10 ⁵ resistive load (at 20 times/min.)	Min. 10 ⁵ resistive load (at 20 times/min.)	Min. 2×10 ⁵ resistive load (at 20 times/min.)	Min. 2×10 ⁵ resistive load (at 20 times/min.)
Conditions	Conditions for operation, transport and storage*3		Ambient temperature: -50 to +70°C -58 to +158°F (without LED); -50 to +60°C -58 to +140°F (with LED) Humidity: 5 to 85% R.H. (Not freezing and condensing at low temperature)				
Unit weight			Approx. 30g 1.06 oz				

Notes: *1. This value can change due to the switching frequency, environmental conditions and desired reliability level, therefore it is recommended to check this with the actual load.
 *2. For the AC coil types, the operate/release time will differ depending on the phase.
 *3. For the ambient temperature, refer to "NOTES".
 *4. When using the socket and terminal socket, be sure to verify the max. continuous current.

3) Switching capacity and expected life

(1) Electrical (at 20 times/min.)

Load	AC				DC		Expected life
	Resistive (cos φ = 1)		Inductive (cos φ ≈ 0.4)		Resistive	Inductive	
Voltage	125V AC	250V AC	125V AC	250V AC	30V DC	30V DC	
1 Form C	10A	10A	5A	3A	—	—	Min. 2×10 ⁵
	7A	7A	3A	2.5A	3A	1A	Min. 5×10 ⁵
	5A	5A	2A	1.5A	—	—	Min. 10 ⁶
2 Form C	7A	7A	3.5A	2A	—	—	Min. 2×10 ⁵
	5A	5A	2.5A	1.5A	3A	0.6A	Min. 5×10 ⁵
	3A	3A	1.5A	1A	—	—	Min. 10 ⁶
3 Form C	7A	7A	—	—	—	—	Min. 10 ⁵
	—	—	3.5A	2A	—	—	Min. 2×10 ⁵
	5A	5A	—	—	3A	0.4A	Min. 5×10 ⁵
4 Form C	5A	5A	2A	1A	—	—	Min. 2×10 ⁵
	3A	3A	1A	0.8A	3A	0.4A	Min. 5×10 ⁵
	2A	2A	0.5A	0.4A	—	—	Min. 10 ⁶
4 Form C (twin)	3A	3A	1A	0.8A	3A	—	Min. 2×10 ⁵

(2) Mechanical (at 180 times/min.)

AC coil type: Min. 5×10⁷; DC coil type: Min. 10⁸

2. Amber sealed type

1) Coil data

Same coil data as HC relay standard type. Please refer to standard type information.

2) Specifications

Characteristics	Item	Specifications			
		1 Form C	2 Form C	4 Form C	4 Form C (twin)
Contact	Arrangement	1 Form C	2 Form C	4 Form C	4 Form C
Rating	Nominal switching capacity (resistive load)	5A 250V AC	3A 250V AC	2A 250V AC	1A 250V AC
	Max. switching power (resistive load)	1,250VA	700VA	500VA	250VA
	Max. switching voltage	250VAC	250VAC	250VAC	250VAC
	Max. switching current	5A	3A	2A	1A
	Min. switching capacity (Reference value)*1	1mA 100mV DC			100μA 100mV DC
Expected life	Electrical	Min. 2×10 ⁵ resistive load (at 20 times/min.)			
Conditions	Conditions for operation, transport and storage*2	Ambient temperature: -40°C to +60°C -40°F to +140°F; Humidity: 5 to 85% R.H. (Not freezing and condensing at low temperature)			

Notes: Other specifications are same as standard types.

*1. This value can change due to the switching frequency, environmental conditions and desired reliability level, therefore it is recommended to check this with the actual load.

*2. For the ambient temperature, refer to "NOTES".

3) Switching capacity and expected life

(1) Electrical (at 20 times/min.)

Load	AC				DC		Expected life
	Resistive (cos φ = 1)		Inductive (cos φ ≒ 0.4)		Resistive	Inductive	
Voltage	125V AC	250V AC	125V AC	250V AC	30V DC	30V DC	
HC1E	5A	5A	—	—	3A	1A	Min. 2×10 ⁵
HC2E	3A	3A	—	—	2A	0.7A	Min. 2×10 ⁵
HC4E	2A	2A	—	—	2A	0.6A	Min. 2×10 ⁵
HC4ED (4 Form C twin)	1A	1A	—	—	—	—	Min. 2×10 ⁵

(2) Mechanical (at 180 times/min.)

AC coil type: Min. 5×10⁷; DC coil type: Min. 10⁸

3. With diode type (For DC)

1) Coil data

Same coil data as HC relay standard type for DC. Please refer to standard type information.

Please connect DC coil type built-in diode correctly by verifying the coil polarity.

2) Specifications

Characteristics	Item	Specifications
Conditions	Conditions for operation, transport and storage*	Ambient temperature: -50°C to +60°C -58°F to +140°F Humidity: 5 to 85% R.H. (Not freezing and condensing at low temperature)

Notes: Other specifications are same as standard type HC relay. Please see the standard type HC relay.

* For the ambient temperature, refer to "NOTES".

REFERENCE DATA

Standard type

1. Life curve

Load: 250 V AC resistive load

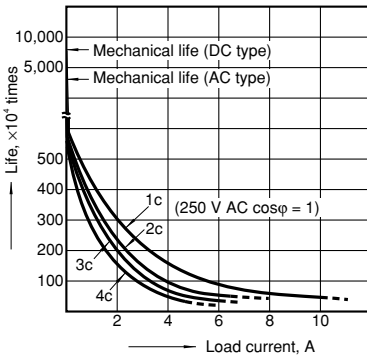

2.-(1) Max. switching capacity (single contact type)

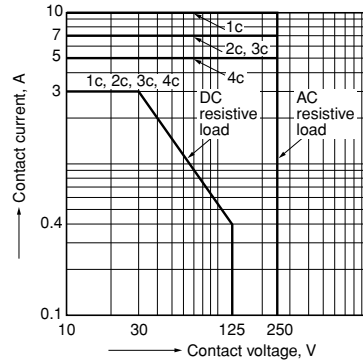

2.-(2) Max. switching capacity [4-pole bifurcated (twin) contact type]

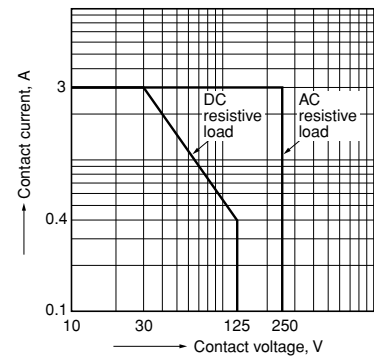

3.-(1) Coil temperature rise (1 Form C, AC type)

Measured portion: Inside the coil
Ambient temperature: 25°C 77°F (See note.)

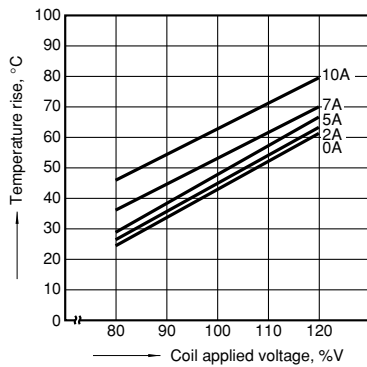

3.-(2) Coil temperature rise (2 Form C, AC type)

Measured portion: Inside the coil
Ambient temperature: 30°C 86°F (See note.)

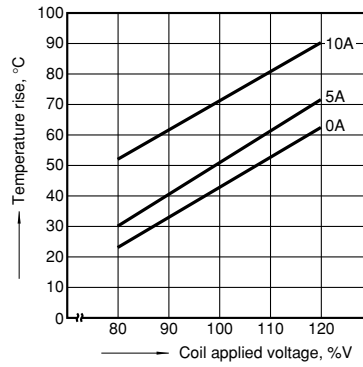

3.-(3) Coil temperature rise (3 Form C, AC type)

Measured portion: Inside the coil
Ambient temperature: 18°C 64°F (See note.)

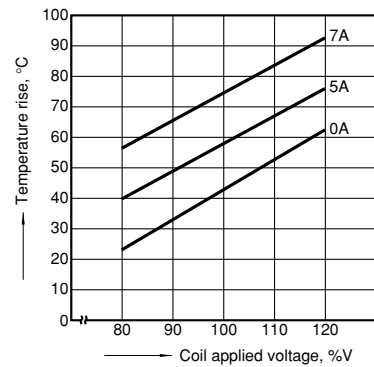

3.-(4) Coil temperature rise (4 Form C, AC type)

Measured portion: Inside the coil
Ambient temperature: 15 to 21°C 59 to 70°F (See note.)

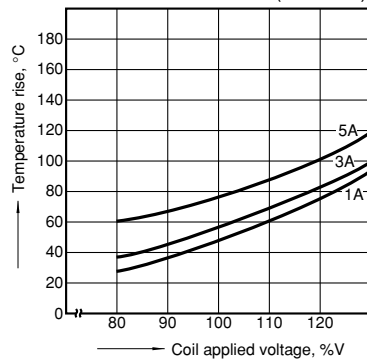

3.-(5) Coil temperature rise (1 Form C, DC type)

Measured portion: Inside the coil
Ambient temperature: 29°C 84°F

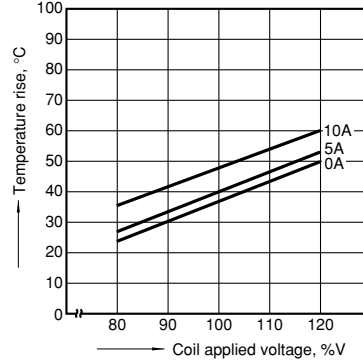

3.-(6) Coil temperature rise (2 Form C, DC type)

Measured portion: Inside the coil
Ambient temperature: 29°C 84°F

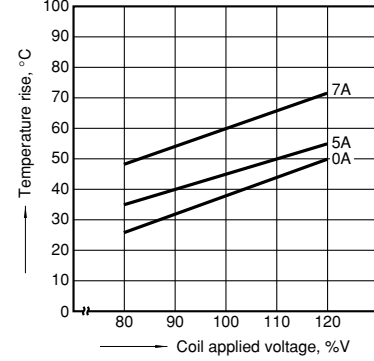

3.-(7) Coil temperature rise (3 Form C, DC type)

Measured portion: Inside the coil
Ambient temperature: 29°C 84°F

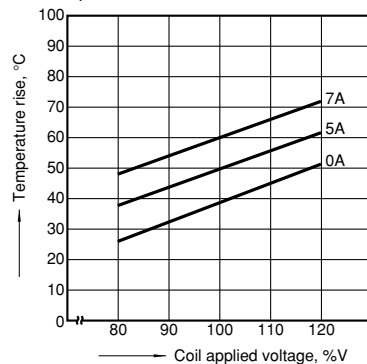

3.-(8) Coil temperature rise (4 Form C, DC type)

Measured portion: Inside the coil
Ambient temperature: 17 to 18°C 62 to 64°F

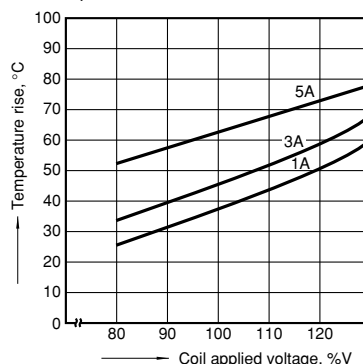

Note: Coil temperature rise

When the nominal voltage is applied to 120 or 240 V AC coil types respectively, the figures of coil temperature rise increase by approx. 10 degrees to the ones shown on each graph.

Amber sealed type

1.-(1) Max. switching capacity
(single contact type)

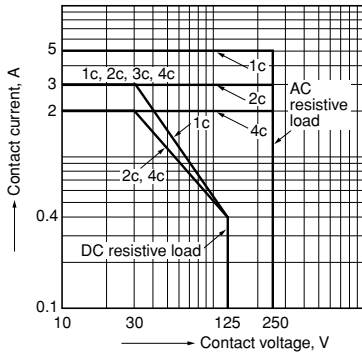

1.-(2) Max. switching capacity
[4-pole bifurcated (twin) contact type]

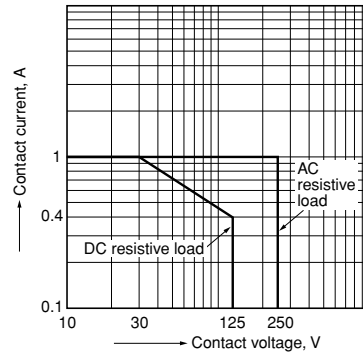

2.-(1) Coil temperature rise (1 Form C AC type)
Measured portion: Inside the coil
Ambient temperature: 30°C 86°F

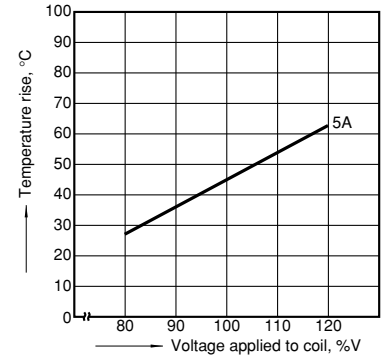

2.-(2) Coil temperature rise (2 Form C AC type)
Measured portion: Inside the coil
Ambient temperature: 30°C 86°F (See note.)

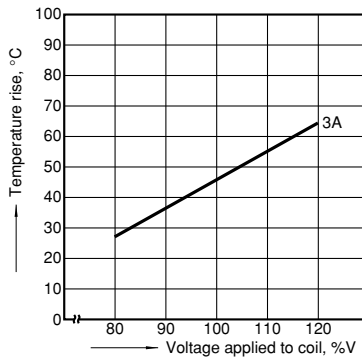

2.-(3) Coil temperature rise (4 Form C AC type)
Measured portion: Inside the coil
Ambient temperature: 30°C 86°F (See note.)

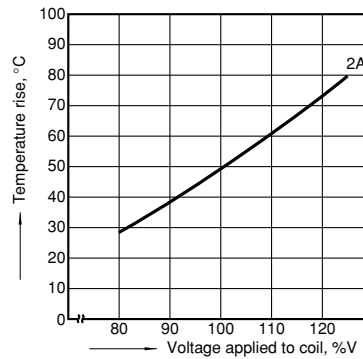

2.-(4) Coil temperature rise (1 Form C DC type)
Measured portion: Inside the coil
Ambient temperature: 30°C 86°F

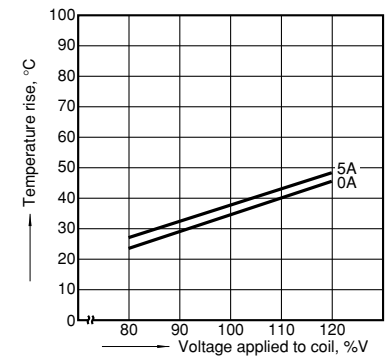

2.-(5) Coil temperature rise (2 Form C DC type)
Measured portion: Inside the coil
Ambient temperature: 30°C 86°F

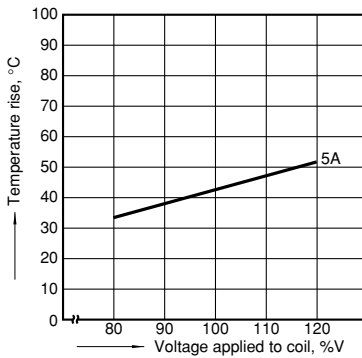

Note: Coil temperature rise
When the nominal voltage is applied to 120 or 240 V AC coil types respectively, the figures of coil temperature rise increase by approx. 10 degrees to the ones shown on each graph.

With diode type (For DC)

1.-(1) DC coil surge voltage waveform
(without diode)

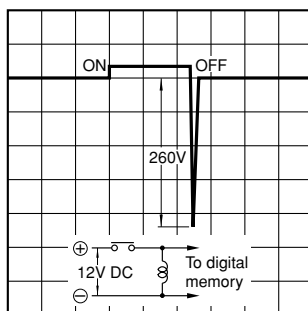

1.-(2) DC coil surge voltage waveform
(with diode)

Diode characteristics;
Reverse breakdown voltage: 1,000V,
Forward current: 1A

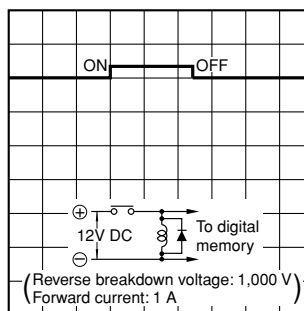

DIMENSIONS (mm inch)

The CAD data of the products with a **CAD Data** mark can be downloaded from: <http://industrial.panasonic.com/ac/e/>

Standard type

- 1) Plug-in type
- 1 Form C

CAD Data



External dimensions

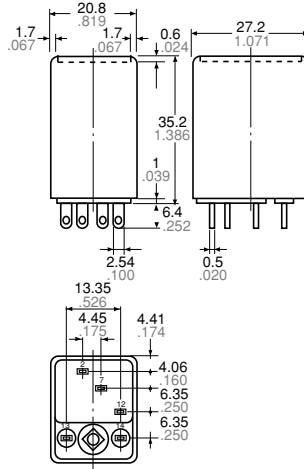

Schematic (Bottom view)

Without LED indication type (AC/DC)

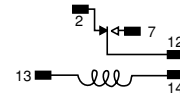

LED AC type

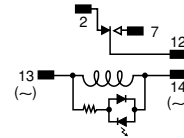

LED DC type

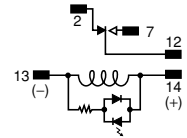

Dimension:

Less than 1mm .039inch:
Min. 1mm .039inch less than 3mm .118 inch:
Min. 3mm .118 inch:

Tolerance

±0.1 ±.004
±0.2 ±.008
±0.3 ±.012

2 Form C

CAD Data



External dimensions

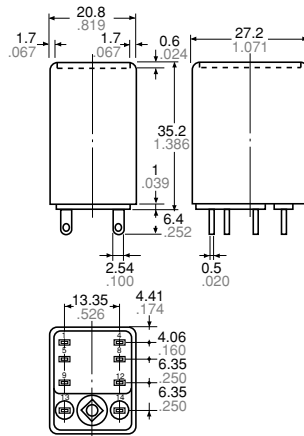

Schematic (Bottom view)

Without LED indication type (AC/DC)

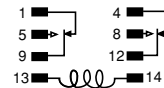

LED AC type

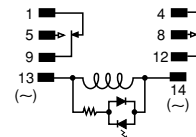

LED DC type

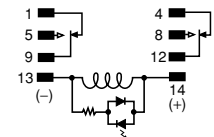

Dimension:

Less than 1mm .039inch:
Min. 1mm .039inch less than 3mm .118 inch:
Min. 3mm .118 inch:

Tolerance

±0.1 ±.004
±0.2 ±.008
±0.3 ±.012

3 Form C

CAD Data



External dimensions

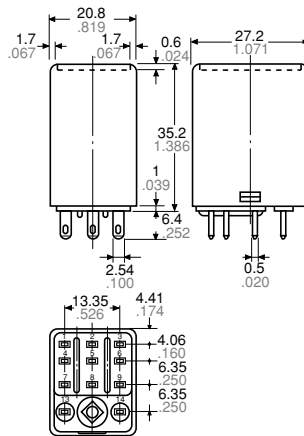

Schematic (Bottom view)

Without LED indication type (AC/DC)

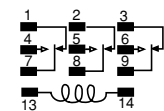

LED AC type

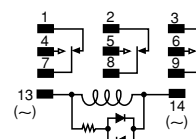

LED DC type

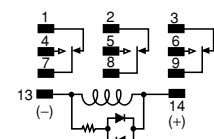

Dimension:

Less than 1mm .039inch:
Min. 1mm .039inch less than 3mm .118 inch:
Min. 3mm .118 inch:

Tolerance

±0.1 ±.004
±0.2 ±.008
±0.3 ±.012

4 Form C and 4-pole bifurcated (twin)

CAD Data



External dimensions

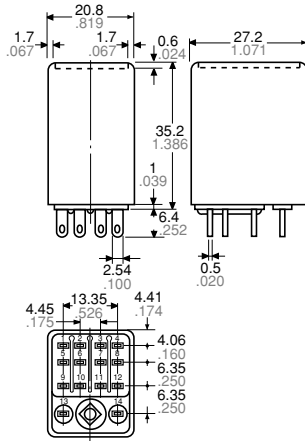

Schematic (Bottom view)

Without LED indication type (AC/DC)

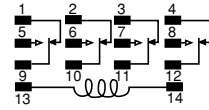

LED AC type

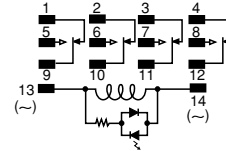

LED DC type

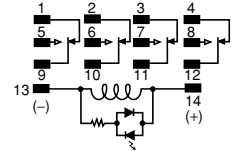

Dimension:

Less than 1mm .039inch:

Min. 1mm .039inch less than 3mm .118 inch: $\pm 0.2 \pm 0.08$

Min. 3mm .118 inch:

Tolerance

$\pm 0.1 \pm 0.04$

$\pm 0.2 \pm 0.08$

$\pm 0.3 \pm 0.12$

2) PC board type

4 Form C

CAD Data



External dimensions

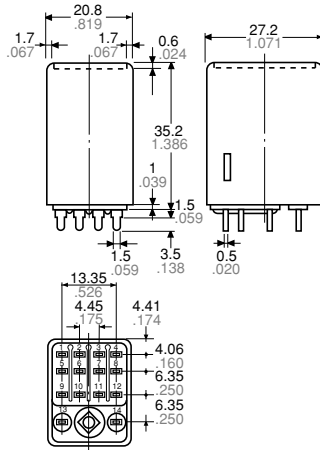

The diagrams show the external dimensions of the 4 Form C and 4-pole bifurcated (twin) types. For 1 Form C, 2 Form C, and 3 Form C, see diagrams at plug-in types (only the terminals are different).

Types with 0.9 mm .035 inch terminal width are also available.

Dimension:

Less than 1mm .039inch:

Min. 1mm .039inch less than 3mm .118 inch: $\pm 0.2 \pm 0.08$

Min. 3mm .118 inch:

Tolerance

$\pm 0.1 \pm 0.04$

$\pm 0.2 \pm 0.08$

$\pm 0.3 \pm 0.12$

PC board pattern

1 Form C

2 Form C

3 Form C

4 Form C

Schematic

Same schematic as plug-in type HC relay

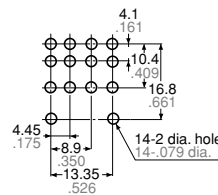
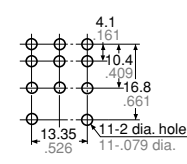
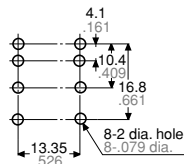
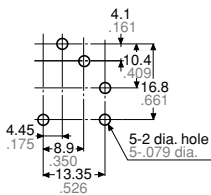

Tolerance: $\pm 0.1 \pm 0.04$

3) TM type
4 Form C

CAD Data

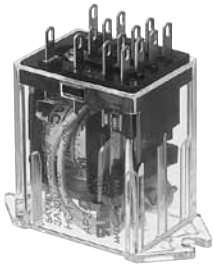

External dimensions

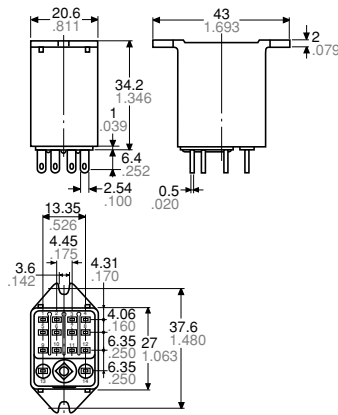

The diagrams show the external dimensions of the 4 Form C and 4-pole bifurcated (twin) types. For 1 Form C, 2 Form C, and 3 Form C, see diagrams at plug-in types (only the terminals are different).

Schematic

Same schematic as plug-in type HC relay. Be aware that there is no LED indicator with built-in diode types.

Dimension:	Tolerance
Less than 1mm .039inch:	±0.1 ±.004
Min. 1mm .039inch less than 3mm .118 inch:	±0.2 ±.008
Min. 3mm .118 inch:	±0.3 ±.012

Chassis (Panel) cutout

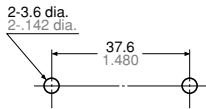

Tolerance: ±0.1 ±.004

Chassis (Panel) cutout in tandem mounting

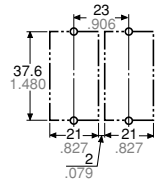

- Notes:
1. In mounting, use M3 screws and M3 washers.
 2. When mounting TM types, use washers to prevent damage or distortion to the polycarbonate cover.
 3. When tightening fixing screws, the optimum torque range should be 0.294 to 0.49 N-m, (3 to 5 kgf-cm). Moreover, use washers to prevent loosening.

Amber sealed type

1) Plug-in type

1 Form C

CAD Data



External dimensions

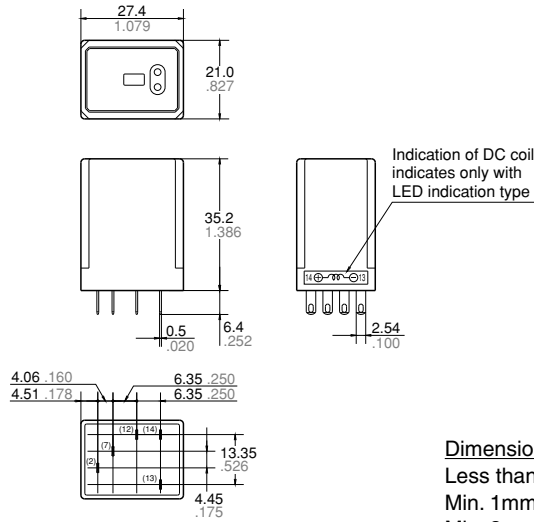

Schematic (Bottom view)

Without LED indication type
(AC/DC)

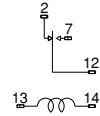

LED AC type

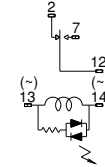

LED DC type

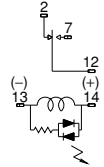

Dimension:

Less than 1mm .039inch:

Min. 1mm .039inch less than 3mm .118 inch: $\pm 0.2 \pm .008$

Min. 3mm .118 inch: $\pm 0.3 \pm .012$

Tolerance

$\pm 0.1 \pm .004$

$\pm 0.2 \pm .008$

$\pm 0.3 \pm .012$

2 Form C

CAD Data



External dimensions

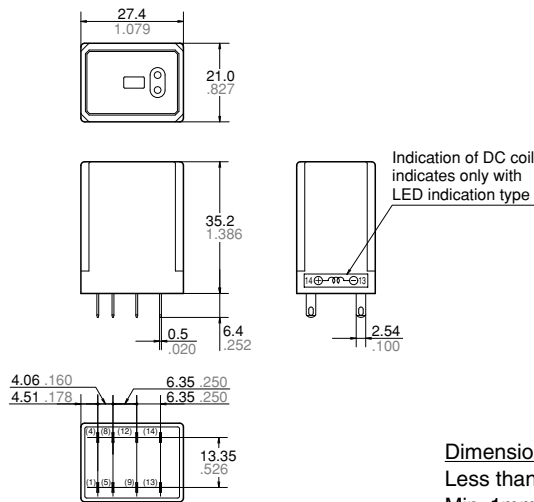

Schematic (Bottom view)

Without LED indication type
(AC/DC)

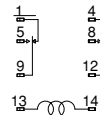

LED AC type

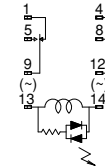

LED DC type

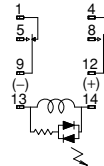

Dimension:

Less than 1mm .039inch:

Min. 1mm .039inch less than 3mm .118 inch: $\pm 0.2 \pm .008$

Min. 3mm .118 inch: $\pm 0.3 \pm .012$

Tolerance

$\pm 0.1 \pm .004$

$\pm 0.2 \pm .008$

$\pm 0.3 \pm .012$

4 Form C and 4-pole bifurcated (twin)

CAD Data



External dimensions

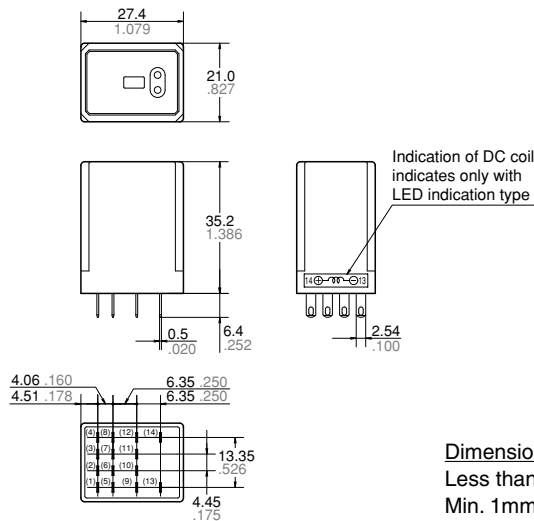

Schematic (Bottom view)

Without LED indication type
(AC/DC)



LED AC type

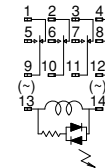

LED DC type

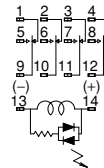

Dimension:

Less than 1mm .039inch:

Min. 1mm .039inch less than 3mm .118 inch: $\pm 0.2 \pm .008$

Min. 3mm .118 inch: $\pm 0.3 \pm .012$

Tolerance

$\pm 0.1 \pm .004$

$\pm 0.2 \pm .008$

$\pm 0.3 \pm .012$

2) PC board type
4 Form C and 4-pole bifurcated (twin)

CAD Data



External dimensions

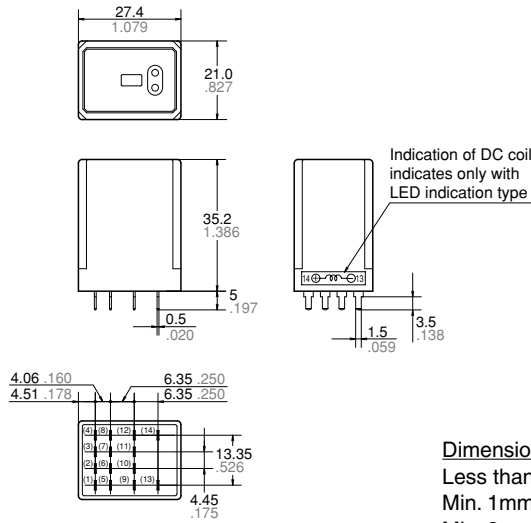

The diagrams show the external dimensions of the 4 Form C and 4-pole bifurcated (twin) types. For 1 Form C, 2 Form C, and 3 Form C, see diagrams at plug-in types (only the terminals are different). Types with 0.9 mm .035 inch terminal width are also available.

Schematic

Same schematic as plug-in type HC relay

Dimension:

Less than 1mm .039inch:

Min. 1mm .039inch less than 3mm .118 inch:

Min. 3mm .118 inch:

Tolerance

±0.1 ±.004

±0.2 ±.008

±0.3 ±.012

PC board pattern

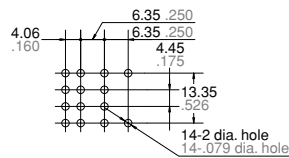

Tolerance: ±0.1 ±.004

3) TM type
4 Form C and 4-pole bifurcated (twin)

CAD Data

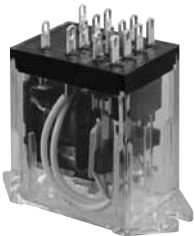

External dimensions

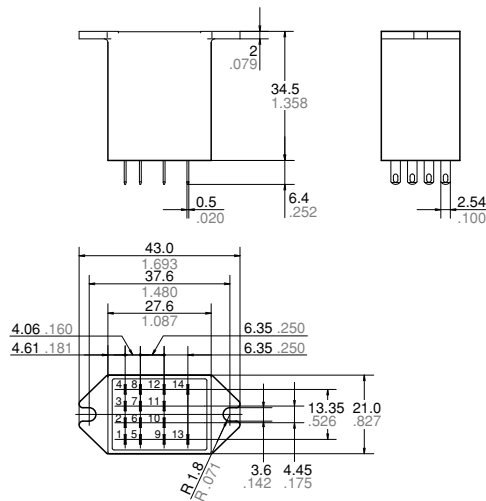

The diagrams show the external dimensions of the 4 Form C and 4-pole bifurcated (twin) types. For 1 Form C, 2 Form C, and 3 Form C, see diagrams at plug-in types (only the terminals are different).

Schematic

Same schematic as plug-in type HC relay
Be aware that there is no LED indicator with built-in diode types.

Chassis (Panel) cutout in tandem mounting

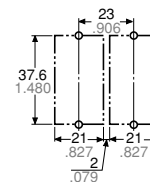

Chassis (Panel) cutout

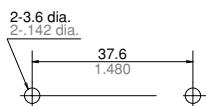

Tolerance: ±0.1 ±.004

Dimension:

Less than 1mm .039inch:

Min. 1mm .039inch less than 3mm .118 inch:

Min. 3mm .118 inch:

Tolerance

±0.1 ±.004

±0.2 ±.008

±0.3 ±.012

Notes: 1. In mounting, use M3 screws and M3 washers.

2. When mounting TM types, use washers to prevent damage or distortion to the polycarbonate cover.

3. When tightening fixing screws, the optimum torque range should be 0.294 to 0.49 N·m, (3 to 5 kgf·cm). Moreover, use washers to prevent loosening.

With diode type (For DC)

Same dimensions as HC relay standard/plug-in type

CAD Data



Schematic
Without LED indicator

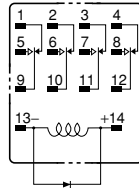

Protection (surge-absorbing) diode

With LED indicator

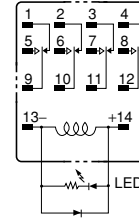

Protection (surge-absorbing) diode

SAFETY STANDARDS

Item	UL/C-UL (Recognized)		CSA (Certified)		VDE (Certified)		TV rating (UL/CSA)		Remarks
	File No.	Contact rating	File No.	Contact rating	File No.	Contact rating	File No.	Rating	
HC Standard	1 Form C	E43028 10A 250V AC 1/8HP 125, 250V AC 3A 30V DC	LR26550 etc.	10A 250V AC 1/8HP 125, 250V AC 3A 30V DC	40017406	10A 250V AC (cosφ=1.0) 3A 250V AC (cosφ=0.4) 3A 30V DC (0ms)	UL E43149 CSA LR26550	TV-3	
	2 Form C	E43028 7A 250V AC 1/8HP 125, 250V AC 3A 30V DC	LR26550 etc.	7A 250V AC 1/8HP 125, 250V AC 3A 30V DC	40017406	7A 250V AC (cosφ=1.0) 2A 250V AC (cosφ=0.4) 3A 30V DC (0ms)	UL E43149 CSA LR26550	TV-3	
	3 Form C	E43028 7A 250V AC 1/8HP 125, 250V AC 3A 30V DC	LR26550 etc.	7A 250V AC 1/8HP 125, 250V AC 3A 30V DC	—	—	—	—	
	4 Form C	E43028 5A 250V AC 1/10HP 125, 250V AC 3A 30V DC	LR26550 etc.	5A 250V AC 1/10HP 125, 250V AC 3A 30V DC	40017406	5A 65V AC (cosφ=1.0) 3A 65V AC (cosφ=0.4) 3A 30V DC (0ms)	—	—	
	4 Form C twin	E43149 3A 250V AC 3A 30V DC	LR26550 etc.	3A 250V AC 3A 30V DC	—	—	—	—	
HC Amber	1 Form C	E43028 6A 250V AC 1/8HP 125, 250V AC 3A 30V DC	LR26550 etc.	6A 250V AC 1/8HP 125, 250V AC 3A 30V DC	—	—	—	—	
	2 Form C	E43028 4A 250V AC 1/10HP 125, 250V AC 3A 30V DC	LR26550 etc.	4A 250V AC 1/10HP 125, 250V AC 3A 30V DC	—	—	—	—	
	4 Form C	E43028 2A 250V AC 1/20HP 125, 250V AC 2A 30V DC	LR26550 etc.	2A 250V AC 1/20HP 125, 250V AC 2A 30V DC	—	—	—	—	
	4 Form C twin	E43149 1A 250V AC 1A 30V DC	LR26550 etc.	1A 250V AC 1A 30V DC	—	—	—	—	
HC with diode type (For DC)	1 Form C	E43028 10A 250V AC 1/8HP 125, 250V AC 3A 30V DC	LR26550 etc.	10A 250V AC 1/8HP 125, 250V AC 3A 30V DC	—	—	—	—	
	2 Form C	E43028 7A 250V AC 1/8HP 125, 250V AC 3A 30V DC	LR26550 etc.	7A 250V AC 1/8HP 125, 250V AC 3A 30V DC	—	—	—	—	
	3 Form C	E43028 7A 250V AC 1/8HP 125, 250V AC 3A 30V DC	LR26550 etc.	7A 250V AC 1/8HP 125, 250V AC 3A 30V DC	—	—	—	—	
	4 Form C	E43028 5A 250V AC 1/10HP 125, 250V AC 3A 30V DC	LR26550 etc.	5A 250V AC 1/10HP 125, 250V AC 3A 30V DC	—	—	—	—	
	4 Form C twin	E43149 3A 250V AC 3A 30V DC	LR26550 etc.	3A 250V AC 3A 30V DC	—	—	—	—	

NOTES

1. For cautions for use, please read “General Application Guidelines”.

2. Diode characteristics

- 1) Reverse breakdown voltage: 1,000 V
- 2) Forward current: 1 A

3. Diode type

Since the diode inside the relay coils are designed to absorb the counter emf, the element may be damaged if a large surge, etc., is applied to the diode. If there is the possibility of a large surge voltage from the outside, please implement measures to absorb it.

4. Please connect DC coil types with LED and built-in diode correctly by verifying the coil polarity (“+” and “-”). Connecting with reverse polarity will cause the LED not to light and damage the built-in diode due to its specification.

Please contact

Panasonic Corporation

Electromechanical Control Business Division

■ 1006, Oaza Kadoma, Kadoma-shi, Osaka 571-8506, Japan
industrial.panasonic.com/ac/e/

Panasonic[®]

©Panasonic Corporation 2017