

Thick Film, Rectangular Chip Resistors

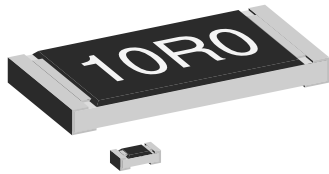

FEATURES

- Metal glaze on high quality ceramic
- Protective overglaze
- Lead bearing (90 % Sn/10 % Pb) solder contacts
- Excellent stability ($\Delta R/R \leq \pm 0.5\%$ for 1000 h at 70 °C) in different environmental conditions
- High volume product suitable for commercial and special applications

STANDARD ELECTRICAL SPECIFICATIONS

MODEL	SIZE		POWER RATING $P_{70\text{ °C}}$ W	LIMITING ELEMENT VOLTAGE MAX V_{Ξ}	TEMPERATURE COEFFICIENT ppm/K	TOLERANCE %	RESISTANCE RANGE Ω	E-SERIES
	INCH	METRIC	CECC 40401-802/EIA-575					
D10 — — — CRCW0402	0402	1005	0.063	50	$\pm 200^{1)}$ ± 100 ± 200	± 1 ± 1 ± 5	1R0 - 9R76 10R - 10M 1R0 - 10M	24 + 96 24 + 96 24
Zero-Ohm-Resistor: $R_{\max} = 20\text{ m}\Omega$, $I_{\max} = 1\text{ A}$								
D11 — — — CRCW0603	0603	1608	0.10	75	$\pm 200^{1)}$ ± 100 ± 200	± 1 ± 1 ± 5	1R0 - 9R76 10R - 10M 1R0 - 10M	24 + 96 24 + 96 24
Zero-Ohm-Resistor: $R_{\max} = 20\text{ m}\Omega$, $I_{\max} = 1.5\text{ A}$								
D12 — — — CRCW0805	0805	2012	0.125	150	$\pm 200^{1)}$ ± 100 ± 200	± 1 ± 1 ± 5	1R0 - 9R76 10R - 10M 1R0 - 10M	24 + 96 24 + 96 24
Zero-Ohm-Resistor: $R_{\max} = 20\text{ m}\Omega$, $I_{\max} = 2\text{ A}$								
D25 — — — CRCW1206	1206	3216	0.25	200	$\pm 200^{1)}$ ± 100 ± 200	± 1 ± 1 ± 5	1R0 - 9R76 10R - 10M 1R0 - 10M	24 + 96 24 + 96 24
Zero-Ohm-Resistor: $R_{\max} = 20\text{ m}\Omega$, $I_{\max} = 2.5\text{ A}$								
CRCW1210	1210	3225	0.33	200	$\pm 200^{1)}$ ± 100 ± 200	± 1 ± 1 ± 5	1R0 - 9R76 10R - 1M0 1R0 - 10M	24 + 96 24 + 96 24
Zero-Ohm-Resistor: $R_{\max} = 20\text{ m}\Omega$, $I_{\max} = 2.5\text{ A}$								
CRCW1218	1218	3246	1.0	200	$\pm 200^{1)}$ ± 100 ± 200	± 1 ± 1 ± 5	1R0 - 9R76 10R - 2M2 1R0 - 2M2	24 + 96 24 + 96 24
Zero-Ohm-Resistor: $R_{\max} = 20\text{ m}\Omega$, $I_{\max} = 4\text{ A}$								
CRCW2010	2010	5025	0.5	400	$\pm 200^{1)}$ ± 100 ± 200	± 1 ± 1 ± 5	1R0 - 9R76 10R - 10M 1R0 - 10M	24 + 96 24 + 96 24
Zero-Ohm-Resistor: $R_{\max} = 20\text{ m}\Omega$, $I_{\max} = 3\text{ A}$								
CRCW2512	2512	6332	1.0	500	$\pm 200^{1)}$ ± 100 ± 200	± 1 ± 1 ± 5	1R0 - 9R76 10R - 10M 1R0 - 10M	24 + 96 24 + 96 24
Zero-Ohm-Resistor: $R_{\max} = 20\text{ m}\Omega$, $I_{\max} = 4\text{ A}$								

Notes

- 100 ppm/K on request
 - Ask about further value ranges
 - For low values see Thick Film rectangular low value resistors
 - For high values see Thick Film rectangular high values
 - Marking and packaging: see appropriate catalog or web pages
- For precision Thick Film CRCW see Thick Film rectangular Precision Resistors
 - Power rating depends on the max. temperature at the solder point, the component placement density and the substrate material
 - AgPd or Pd terminations for conductive adhesive attachment on request

TECHNICAL SPECIFICATIONS

PARAMETER	UNIT	D10 CRCW0402	D11 CRCW0603	D12 CRCW0805	D25 CRCW1206	CRCW1210	CRCW1218	CRCW2010	CRCW2512
Rated Dissipation at 70 °C (CECC 40401 EIA 575)	W	0.063	0.10	0.125	0.25	0.33	1.0	0.5	1.0
Limiting Element Voltage ²⁾	V_{Ξ}	50	75	150	200	200	200	400	500
Insulation Voltage (1 min)	V_{peak}	> 75	> 100	> 200	> 300	> 300	> 300	> 300	> 300
Thermal Resistance	K/W	$\leq 870^{1)}$	$\leq 550^{1)}$	$\leq 440^{1)}$	$\leq 220^{1)}$	$\leq 140^{3)}$	$\leq 65^{3)}$	$\leq 88^{3)}$	$\leq 65^{3)}$
Insulation Resistance	Ω	$> 10^9$							
Category Temperature	°C	- 55/+ 125 (+ 155)							
Failure Rate	h^{-1}	0.3×10^{-9}							
Weight/1000 pcs	g	0.65	2	5.5	10	16	29.5	25.5	40.5

Notes

1. Measuring conditions in acc. to CECC 4040
2. Rated voltage: $\sqrt{P \times R}$
3. Depending on solder pad dimensions



DIMENSIONS

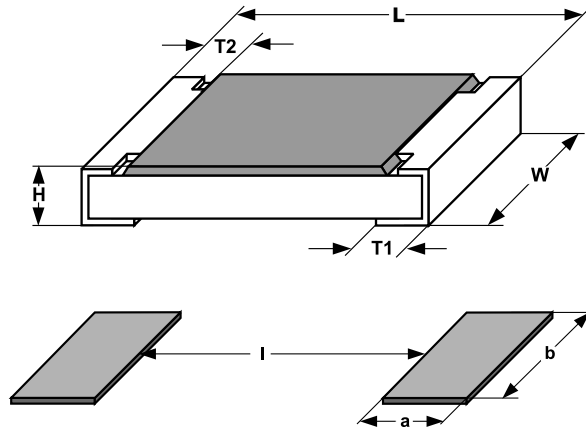

SIZE		DIMENSIONS [in millimeters]				
INCH	METRIC	L	W	H	T1	T2
0402	1005	1.0 ± 0.05	0.5 ± 0.05	0.35 ± 0.05	0.25 ± 0.05	0.2 ± 0.1
0603	1608	1.55 ^{+0.10} _{-0.05}	0.85 ± 0.1	0.45 ± 0.05	0.3 ± 0.2	0.3 ± 0.2
0805	2012	2.0 ^{+0.20} _{-0.10}	1.25 ± 0.15	0.45 ± 0.05	0.3 ^{+0.20} _{-0.10}	0.3 ± 0.2
1206	3216	3.2 ^{+0.10} _{-0.20}	1.6 ± 0.15	0.55 ± 0.05	0.45 ± 0.2	0.4 ± 0.2
1210	3225	3.2 ± 0.2	2.5 ± 0.2	0.55 ± 0.05	0.45 ± 0.2	0.4 ± 0.2
1218	3246	3.2 ^{+0.10} _{-0.20}	4.6 ± 0.15	0.55 ± 0.05	0.45 ± 0.2	0.4 ± 0.2
2010	5025	5.0 ± 0.15	2.5 ± 0.15	0.6 ± 0.1	0.6 ± 0.2	0.6 ± 0.2
2512	6332	6.3 ± 0.2	3.15 ± 0.15	0.6 ± 0.1	0.6 ± 0.2	0.6 ± 0.2

SIZE		SOLDER PAD DIMENSIONS [in millimeters]					
INCH	METRIC	REFLOW SOLDERING			WAVE SOLDERING		
		a	b	l	a	b	l
0402	1005	0.4	0.6	0.5			
0603	1608	0.5	0.9	1.0	0.9	0.9	1.0
0805	2012	0.7	1.3	1.2	0.9	1.3	1.3
1206	3216	0.9	1.7	2.0	1.1	1.7	2.3
1210	3225	0.9	2.5	2.0	1.1	2.5	2.2
1218	3246	1.05	4.9	1.9	1.25	4.8	1.9
2010	5025	1.0	2.5	3.9	1.2	2.5	3.9
2512	6332	1.0	3.2	5.2	1.2	3.2	5.2

PART NUMBER AND PRODUCT DESCRIPTION¹⁾

PART NUMBER: D1208050B5620FP0



MODEL/SIZE	SPECIAL CHARACTER	TCR	VALUE	TOLERANCE	PACKAGING ²⁾	SPECIAL
D100402 D110603 D120805 D251206	0 = neutral	B = ± 100 ppm/K A = ± 200 ppm/K 0 = Jumper	3 digit value 1 digit multiplier MULTIPLIER 7 = *10 ⁻³ 2 = *10 ² 8 = *10 ⁻² 3 = *10 ³ 9 = *10 ⁻¹ 4 = *10 ⁴ 0 = *10 ⁰ 5 = *10 ⁵ 1 = *10 ¹ 6 = *10 ⁶ 0000 = Jumper	F = ± 1 % J = ± 5 %	P0 M0 P5 PZ PN B5 MZ BN MU	up to 2 digits
PRODUCT DESCRIPTION: D12 100 562R 1% P5						
D12	100	562R	1%	P5		
MODEL	TCR	RESISTANCE VALUE	TOLERANCE	PACKAGING ²⁾		
D10 D11 D12 D25	± 100 ppm/K ± 200 ppm/K	49K9 = 49.9 kΩ 5R1 = 5.1 Ω 0R0 = Jumper	± 1 % ± 5 %	P0 M0 P5 PZ PN B5 MZ BN MU		

PART NUMBER: CRCW08055620F100RT1

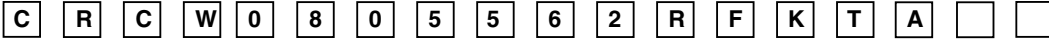

MODEL/SIZE	VALUE	TOLERANCE	TCR	PACKAGING ²⁾	SPECIAL
CRCW0402 CRCW0603 CRCW0805 CRCW1206 CRCW1210 CRCW1218 CRCW2010 CRCW2512	R = Decimal K = Thousand M = Million 0000 = Jumper	F = ± 1 % J = ± 5 % Z = Zero Ohm Jumper	K = ± 100 ppm/K N = ± 200 ppm/K S = Jumper or Special	TA = RT1 TB = RT5 TC = RT6 TD = RT7 TF = R02 TG = R67 TH = R82 TK = RT9 BA = B27	up to 2 digits TR = Customer Trimmable
PRODUCT DESCRIPTION: CRCW 0805 5620 F 100 RT1					
CRCW	0805	5620	F	100	RT1
MODEL	SIZE	RESISTANCE VALUE	TOLERANCE	TCR	PACKAGING ²⁾
CRCW	0402 1201 0603 1218 0805 2010 1206 2512	685 = 6.8 MΩ 224 = 220 kΩ	F = ± 1 % J = ± 5 % Z = Zero Ohm Jumper	± 100 ppm/K ± 200 ppm/K	RT1 R67 RT5 R82 RT6 R89 RT7 B27 R02
± 1 % = 3 sig.digits, plus multiplier ± 5 % = 2 sig.digits, plus multiplier					

Notes

1. Preferred way for ordering products is by use of the PART NUMBER.
2. Please refer to table PACKAGING, page 116.

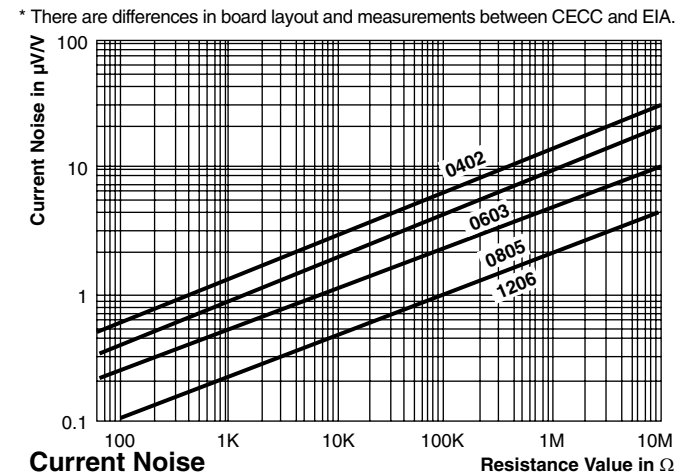
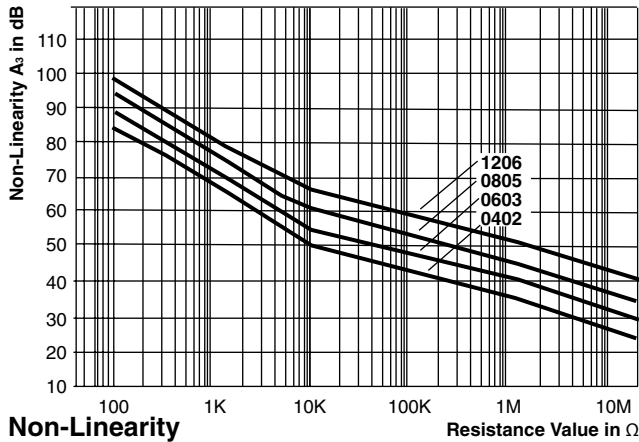
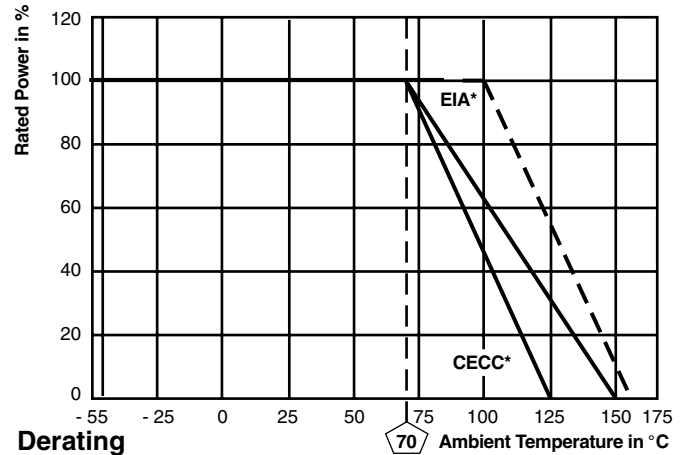
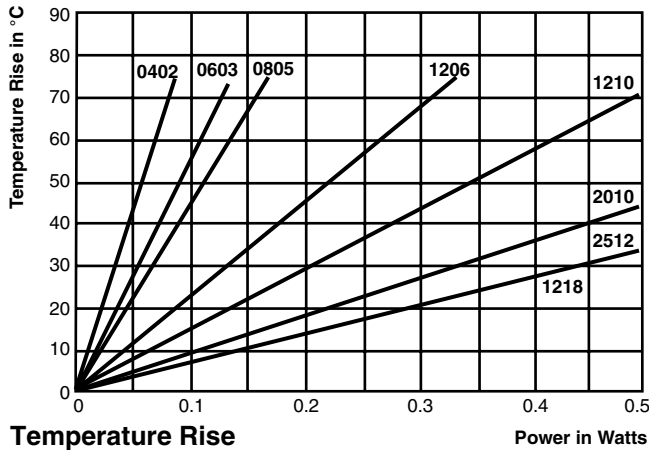

* There are differences in board layout and measurements between CECC and EIA.

PACKAGING								
MODEL	REEL				BULK			
	TAPE WIDTH	DIAMETER	PIECES/REEL	PITCH	PACKAGING CODE		BULK FEEDING MAGAZINE	
					PAPER ¹⁾	BLISTER ²⁾	PIECES ¹⁾	CODE ²⁾
D10 CRCW0402	8 mm	180 mm/7"	10 000	2 mm	P0/TD		50 000	MZ/BA
		330 mm/13"	50 000	2 mm	PZ/TE			
D11 CRCW0603	8 mm	180 mm/7"	5000	4 mm	P5/TA	B5/na	25 000	MU/BA
		255 mm/10"	10 000	4 mm	P0/TB	BN/na		
D12 CRCW0805	8 mm	180 mm/7"	5000	4 mm	P5/TA	B5/na	10 000	MO/BA
		255 mm/10"	10 000	4 mm	P0/TB	BN/na		
D25 CRCW1206	8 mm	180 mm/7"	5000	4 mm	P5/TA	B5/na		
		255 mm/10"	10 000	4 mm	P0/TB	BN/na		
CRCW1210	8 mm	180 mm/7"	5000	4 mm	P5/TA	B5/RG1		
		330 mm/13"	20 000	4 mm	PN/TC	BN/na		
CRCW1218	12 mm	180 mm/7"	4000	4 mm		TK		
CRCW2010	12 mm	180 mm/7"	4000	4 mm		TF		
CRCW2512	12 mm	180 mm/7"	2000	8 mm		B2/TG		
				4 mm		TH		

Notes

- On request
- European/N.American packaging codes: na = NOT AVAILABLE

- Further information about packaging: see appropriate catalog or web page.

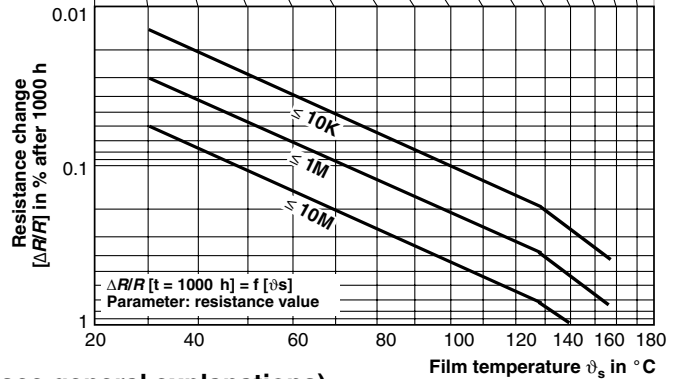
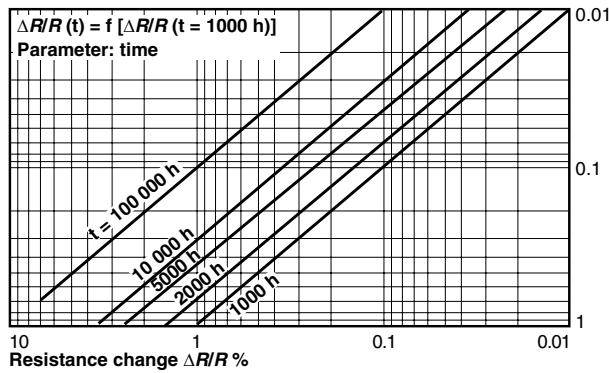
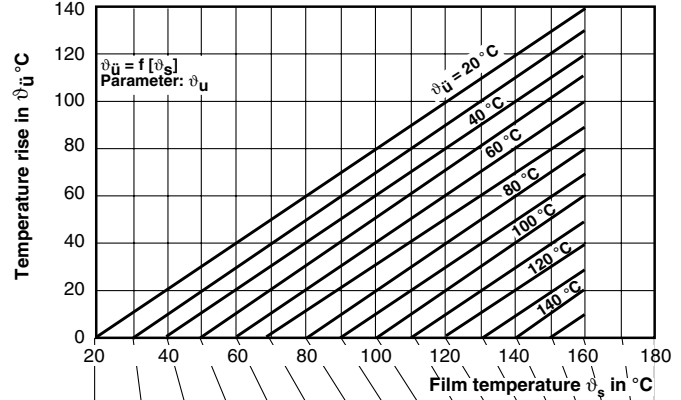
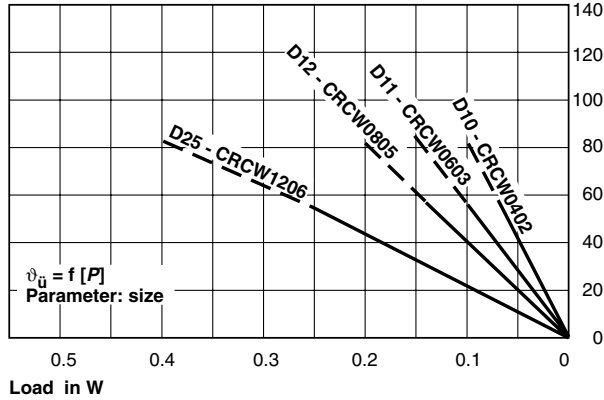

Stability nomogram typical values (for handling see general explanations)

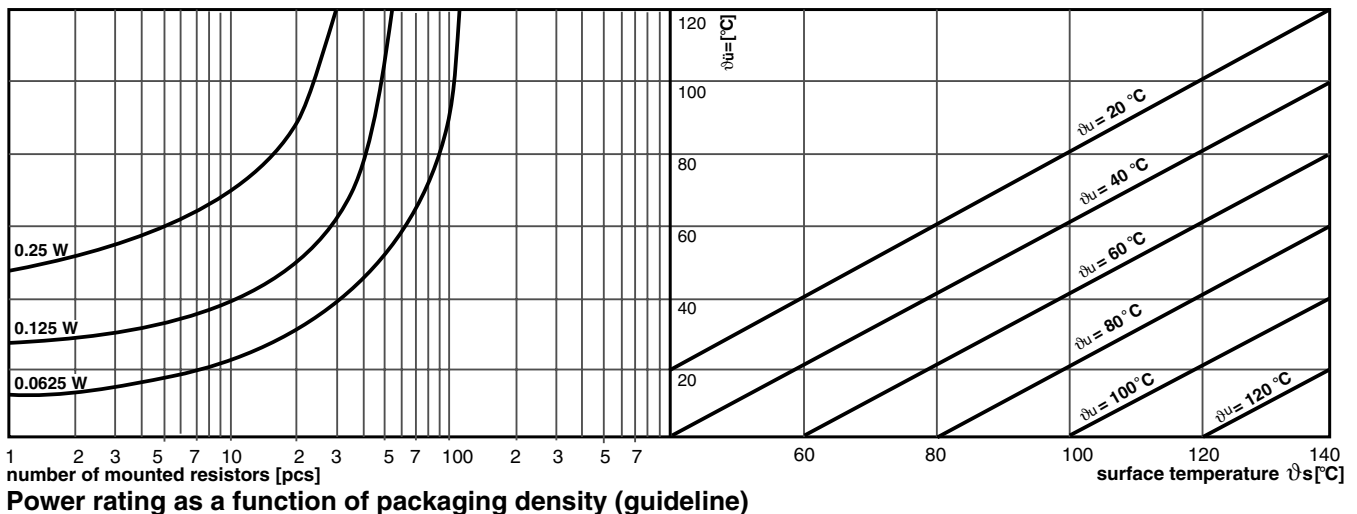

Power rating as a function of packaging density (guideline)

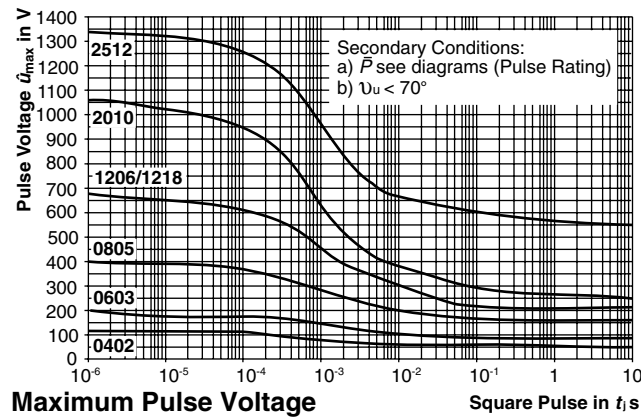
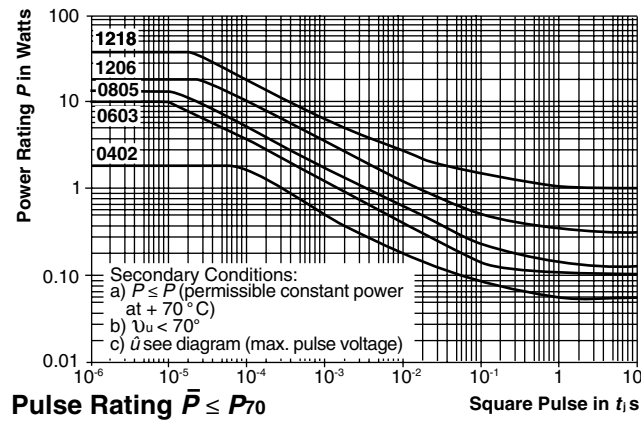
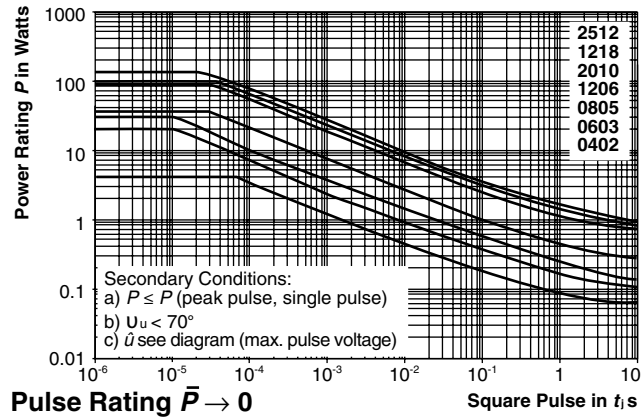



PERFORMANCE				
TEST	CONDITIONS OF TEST	REQUIREMENTS IN %¹⁾		
		0402 0603	0805 1206 1210	1218 2010 2512
Endurance Test at 70 °C IEC 60115-1 4.25.1; EIA-575	1000 hours at 70 °C, 1.5 hours "ON", 0.5 hours "OFF"	≤ ± 1.0	≤ ± 0.5	≤ ± 1.0
Endurance at UCT IEC 60115-1 4.25.3	1000 hours at 125 °C without load	≤ ± 1.0	≤ ± 0.5	≤ ± 1.0
Overload Test IEC 60115-1 4.13; EIA-575	Short time overload, 2.5 x rated voltage or 2 x limiting element voltage.	≤ ± 0.25	≤ ± 0.25	≤ ± 0.5
Thermal Shock IEC 60115-1 4.19; IEC 60068-2-14; EIA-575	Rapid change between upper and lower category temperature	≤ ± 0.25	≤ ± 0.25	≤ ± 0.5
Damp Heat Steady State IEC 60115-1 4.24; IEC 60068-2-3	56 days at 40 °C and 93 % relative humidity	≤ ± 1.0	≤ ± 0.5	≤ ± 1.0
Resistance to Soldering Heat IEC 60115-1 4.18; IEC 60068-2-20; EIA-575	10 seconds at 260 °C solder bath temperature	≤ ± 0.25	≤ ± 0.25	≤ ± 0.5

Note

1. Limits for change of resistance at test acc. to CECC

APPLICABLE SPECIFICATIONS

- CECC40000/40400/40401-004,-006,-007,-802
- EN140400/IEC 60115-1
- EIA-575



Notice

Specifications of the products displayed herein are subject to change without notice. Vishay Intertechnology, Inc., or anyone on its behalf, assumes no responsibility or liability for any errors or inaccuracies.

Information contained herein is intended to provide a product description only. No license, express or implied, by estoppel or otherwise, to any intellectual property rights is granted by this document. Except as provided in Vishay's terms and conditions of sale for such products, Vishay assumes no liability whatsoever, and disclaims any express or implied warranty, relating to sale and/or use of Vishay products including liability or warranties relating to fitness for a particular purpose, merchantability, or infringement of any patent, copyright, or other intellectual property right.

The products shown herein are not designed for use in medical, life-saving, or life-sustaining applications. Customers using or selling these products for use in such applications do so at their own risk and agree to fully indemnify Vishay for any damages resulting from such improper use or sale.