

Photovoltaic Combiner Boxes

BCBCT Series Compact Combiner Boxes

Features

- UL Listed to UL1741 Standard
- cUL Certified to CSA Standard C22.2 No. 107.1-01
- 2 to 6 Input circuits
- Continuous duty rated at 600Vdc
- 600Vdc Midget fuses* for overcurrent protection
- Finger-safe Cooper Bussmann modular fuse holders**
- NEMA 4X Fiberglass enclosure
- Ground blocks included
- Operating temperature -40°C to 50°C
- Common configurations in stock for fast shipment†
- Negative pass-through (number of inputs = number of circuits)

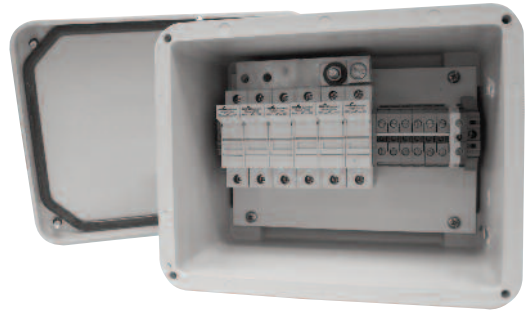

BCBCT Series Compact Box

Specifications††			
Number of Input Circuits	2 to 3	4	5 to 6
Input conductor range	10AWG	10-14AWG	14-16AWG
Number of output conductors	1	1	1
Output conductor range	4-10AWG	3-10AWG	4-14AWG
Max rated current (DC continuous)	50A for 2 Circuits 75A for 3 Circuits	80A	60A for 5 Circuits 72A for 6 Circuits
Max fuse size	25A	20A	12A
Enclosure dimensions (in), Weight	7.6x7.5x4.9, 4 lbs	7.6x7.5x4.9, 4 lbs	9.6x7.5x4.9, 5 lbs

Part Number System Compact Combiner Box Part Number System

Example: BCBCT-04-XXF = B C B C T - 0 4 - 0 0 F

Series Prefix	BCBCT – Compact Combiner Box	_____
Number of Poles	02 03 04 05 06	_____
Fuses (Amps)†	00 – No Fuses Included	_____
	01 02 03 04 05 06 07 08 09	
	10 12 15 20 25 (see Max fuse size in table)	
NEMA Enclosure	F – 4X (fiberglass)	_____

Typical Layout

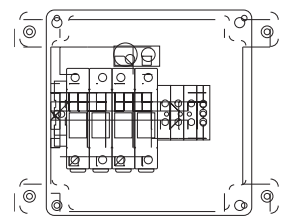

Compact BCBCT Series
2 to 6 Circuits
BCBCT-04-00F Pictured

* See DCM Data Sheet 2038 for details.

** See Data Sheet 2053 for details.

† Please verify stocked configurations with your Cooper Bussmann sales representative.

†† Certain specifications may be modified to meet requirements, please consult factory.

‡ When fuses are specified, 600Vdc midget fuses are installed in holders. When ordering without fuses, the combiner box should be fused according to the local AHJ.

BCBS 600Vdc and 1000Vdc Series Standard Combiner Boxes

Features

- 600Vdc UL Listed to UL1741 Standard*
- 100Vdc Self certified
- 4 to 24 Input circuits
- 600Vdc or 1000Vdc Rated units
- Finger-safe Cooper Bussmann modular fuse holders*
- Configured for both positive and negative grounded arrays
- Single or dual 90°C output terminals
- Negative input terminal blocks
- Steel or fiberglass NEMA 3R, 4 or 4X enclosures with seamless door gaskets
- Operating temperature -40°C to 50°C
- Common configurations in stock for fast shipment**



BCBS Series Standard Box

Specifications***

Voltage	600Vdc Series			1000Vdc Series		
	Rating standard	Listed to UL1741 cUL Listed to CSA Standard C22.2 No. 107.1-01			IEC Rated Components Self-Certified Fuse Gear	
Fuse type	600Vdc Midget fuses†			1000Vdc PV fuses†		
Number of input circuits	4 to 12	16	20 to 24	4 to 12	16	20 to 24
Input conductor range	10-14AWG	10-14AWG	10-14AWG	10-14AWG	10-14AWG	10-14AWG
Number of output conductors	1††	2	2	1	2	2
Output conductor range	300kcmil-1AWG	3/0AWG	300kcmil-4/0AWG	300kcmil-1AWG	3/0AWG	300kcmil-4/0AWG
Max fuse size	25A for 4-8 Circuits 20A for 12 Circuits	20A	20A	20A	20A	20A
Max rated current (DC continuous)	100A for 4 Circuits 200A for 8 Circuits 240A for 12 Circuits	320A	400A for 20 Circuits 480A for 24 Circuits	100A for 4 Circuits 200A for 8 Circuits 240A for 12 Circuits	320A	400A for 20 Circuits 480A for 24 Circuits
Steel enclosure dimensions (in), weight	16x12x6, 30 lbs	16x16x6, 36 lbs	20x16x6, 40 lbs	16x12x6, 30 lbs	16x16x6, 36 lbs	20x16x6, 40 lbs
Fiberglass enclosure dim. (in), weight	18x16x6, 20 lbs	18x16x9, 30 lbs	22x18x9, 31 lbs	18x16x6, 20 lbs	18x16x9, 30 lbs	22x18x9, 31lbs

Part Number System Standard Combiner Box Part Number System

Example: BCBSK-12-XXFS06R M

Series Prefix	BCBS – Standard Combiner Box	_____
	Blank – for 600Vdc systems	_____
	K – for 1000Vdc systems	_____
Number of Poles	04 08 12 16 20 24	_____
Fuses (amps) †	00 – No Fuses Included	_____
	600Vdc fuses 01 02 03 04 05 06 07	_____
	08 09 10 12 15 20 25 (see Max fuse size in table)	_____
	1000Vdc fuses 01 02 03 04 05 06 08	_____
	10 12 15 20 (see Max fuse size in table)	_____
NEMA Enclosure	R – 3R	_____
	4 – 4 (powder coated steel)	_____
	F – 4X (fiberglass)	_____
Surge Protective Device (SPD)**	S06 – 600Vdc	_____
	S10 – 1000Vdc	_____
	Blank – No SPD	_____
SPD Remote Contact Signaling	R – With remote signaling	_____
	Blank – No remote contact	_____
Current Monitoring Device	M – With current monitoring device	_____
	Blank – Without current monitoring device	_____

Typical Layout

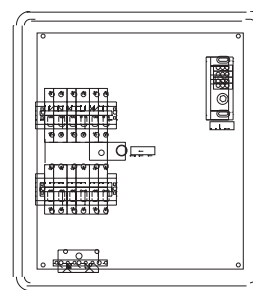

Standard BCBS Series
4 to 24 Circuits
BCBS-12-00F Pictured

* Excludes SPD and current monitoring options.

* See Data Sheet 2053 for details.

** Please verify stocked configurations with your Cooper Bussmann sales representative. Ordering surge protective device and/or current monitoring options may require a custom product. Consult factory for specific size before ordering.

*** Certain specifications may be modified to meet requirements, please consult factory.

† See DCM Data Sheet 2038 for for 600Vdc fuses details and Solar PV Data Sheet 720110 for 1000Vdc fuse details.

†† Two (2) for 12 string (+) output only.

‡ When fuses are specified for 600Vdc combiner boxes, midget fuses are installed in the holders, for 1000Vdc combiner boxes, Solar PV fuses are installed in holders. When ordering without fuses, the combiner box should be fused according to the local AHJ.

‡‡ See Data Sheet 2055 for details.

BCBD Series with Integrated Disconnect

Features

- UL Listed to UL1741 Standard*
- cUL Certified to CSA Standard C22.2 No. 107.1-01
- 150 and 245A Integrated disconnect switches
- 4 to 24 Input circuits
- Continuous duty rated at 600Vdc
- 600Vdc Midget fuses* for overcurrent protection
- Finger-safe Cooper Bussmann modular fuse holders**
- Configured for both positive and negative grounded arrays
- Single or dual 90°C output terminals
- Negative input terminal blocks
- Steel or fiberglass NEMA 3R, 4 or 4X enclosures with seamless door gaskets
- Operating temperature -40°C to 50°C
- Common configurations in stock for fast shipment***

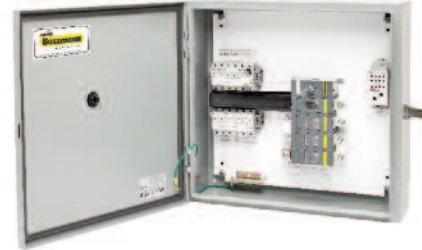

BCBD Series Integrated Disconnect Box

Specifications†				
Disconnect Rating (Amps)	150A		245A	
Number of input circuits	4 to 12	16 to 24	4 to 12	16 to 24
Input conductor range	8 - 14AWG	14AWG	8 - 10AWG	14AWG
Number of output conductors	1	1	1	1
Output conductor range	2/0-2AWG	2/0-1/0AWG	300kcmil - 2AWG	300kcmil - 4/0AWG
Max fuse size/number of circuits	30A for 4 Circuits 15A for 8 Circuits 12A for 12 Circuits	8A for 16 Circuits 6A for 20 Circuits 6A for 24 Circuits	30A for 4 Circuits 30A for 8 Circuits 20A for 12 Circuits	12A for 16 Circuits 12A for 20 Circuits 10A for 24 Circuits
Max rated current (DC continuous)	120A for 4 or 8 Circuits 144A for 12 Circuits	128A for 16 Circuits 120A for 20 Circuits 144A for 24 Circuits	120A for 4 Circuits 240A for 8 or 12 Circuits	192A for 16 Circuits 240A for 20 or 24 Circuits
Steel enclosure dimensions (in), weight	20x16x6, 50lbs	24x20x6, 62lbs	24x20x6, 62lbs	24x24x6, 72lbs
Fiberglass enclosure dimensions (in), weight	22x18x9, 38lbs	27x21x10, 60lbs	27x21x10, 60lbs	27x25x12, 61lbs

Part Number System Combiner Box with Disconnect Part Number System

Example: BCBD150-12-XXFS06R M

Series Prefix	BCBD – Combiner Box w/ Disconnect
Disconnect Ampacity	150A 245A
Number of Poles	04 08 12 16 20 24
Fuses (Amps)‡	00 – No Fuses Included
	01 02 03 04 05 06 07 08 09 10
	12 15 20 25 30 (see Max fuse size in table)
NEMA Enclosure	R – 3R
	4 – 4 (powder coated steel)
	F – 4X (fiberglass)
Surge Protective Device (SPD)‡‡‡	S06 – 600Vdc
	Blank – No SPD
SPD Remote Contact Signaling	R – With remote signaling
	Blank – No remote contact
Current Monitoring Device	M – With current monitoring
	Blank – Without current monitoring device

Typical Layout

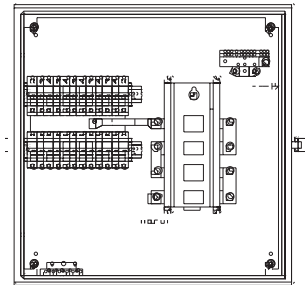

Integral Disconnect on BCBD Series
4 to 24 Circuits
BCBD245-24-00R Pictured

† Excludes current monitoring options and 24-pole circuit with SPD.

* See DCM Data Sheet 2038 for details.

** See Data Sheet 2053 for details.

*** Please verify stocked configurations with your Cooper Bussmann sales representative. Ordering surge protective device and/or current monitoring options may require a custom product. Consult factory for specific size before ordering.

† Certain specifications may be modified to meet requirements, please consult factory.

‡ When fuses are specified, 600Vdc midget fuses are installed in holders. When ordering without fuses, the combiner box should be fused according to the local AHJ.

‡‡ See Data Sheet 2055 for details.

Recombiner (Array Combiner) Boxes

Features

- Self certified to UL1741 Standard
- 4 to 12 Input circuits
- Continuous duty rated at 600Vdc
- 600Vdc PVS-R Fuses* for overcurrent protection
- 100A and 200A Fuse case sizes
- 70A – 200A Fuse ampacity configurations
- Steel or fiberglass NEMA 3R, 4 or 4X rated enclosures with seamless door gaskets
- Operating temperature -40°C to 50°C



Specifications**						
Fuse Case Size	100			200		
Number of input circuits	4	8	12	4	8	12
Number of output conductors	2	4	4	2	4	4
Input conductor range	1/0-8AWG	1/0-8AWG	1/0-8AWG	250MCM-6AWG	250MCM-6AWG	250MCM-6AWG
Output conductor range	4-500kcmil	4-500kcmil	4-500kcmil	4-500kcmil	4-500kcmil	4-500kcmil
Max fuse rating	up to 100A	up to 100A	up to 100A	up to 200A	up to 200A	up to 200A
Max rated current (DC continuous)	760A	1520A	1520A	760A	1520A	1520A
Steel Enclosure dimensions (in), weight	24x24x8, 65 lbs	36x30x8, 125 lbs	42x36x8, 175 lbs	36x30x12, 140 lbs	36x30x12, 160 lbs	48x36x12, 220 lbs
Fiberglass Enclosure dimensions (in), weight	24x24x10, 34 lbs	36x30x8, 94 lbs	48x36x12, 110 lbs	36x30x12, 94 lbs	36x30x12, 135 lbs	48x36x12, 160 lbs

Recombiner Box Part Number System

Example: BCBR1-08-125RS06RM = **BCBR 1 - 08 - 125 R S 06 R M**

Series Prefix	BCBR – Recombiner Box
Fuse Case Size	1 – 100A 2 – 200A
Number of Circuits	04 08 12
Fuses (Amps)***	000 – No Fuses Included 070 080 090 100 (100 amp fuse case size) 125 150 175 200 (200 amp fuse case size)
NEMA Enclosure	R – 3/3R 4 – 4 (powder coated steel) F – 4X (fiberglass)
Surge Protective Device (SPD)†	S06 – 600Vdc Blank – No SPD
SPD Remote Contact Signaling	R – With remote signaling Blank – no remote contact
Current Monitoring Device	M – With current monitoring Blank – No current monitoring device

* See Data Sheet 4203 for details.

** Certain specifications may be modified to meet requirements, please consult factory.

*** Fuse ampacity must coincide with fuse case size specified e.g., 100A or 200A. When ordering without fuses, the combiner box should be fused according to the local AHJ.

† See Data Sheet 2055 for details.

Integrated Surge Protective Device*

Features

- Only true UL 1449 3rd Edition (Type 2)
- IEC 61643-11 Type 2, IEC 61643-1 Class II
- Available in standard and disconnect combiner boxes**
- UL 94V0 Thermoplastic material
- IP20 Finger-safe
- 600Vdc, 1000Vdc configurations
- *easyID*TM Visual status indication
- Available with remote contact signaling
- Operating temperature -40°C to 80°C
- Five year warranty†



BSPH____YPV(R)



Dimensions - mm

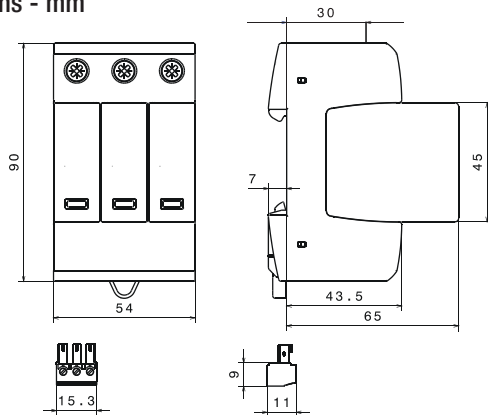

*easyID*TM
Visual Status Indication



Remote Signal Contact Available



Specifications

Max Continuous Operating Voltage	600Vdc	1000Vdc
Total Discharge Current	40kA	40kA
Voltage Protection Level	≤2.5kV	≤4.0kV
Voltage Protection Level at 5kA	≤2.0kV	≤3.5kV
Integrated Fuse Breaking Capacity	30kA	30kA
Nominal Discharge Current	12.5kA	12.5kA
Max Discharge Current	25kA	25kA
Response time	≤25ns	≤25ns
Min Conductor Ratings	60/75°C 14AWG	
Max Conductor Ratings	60/75°C 2AWG Stranded 4AWG Flexible	

Typical Application Schematics

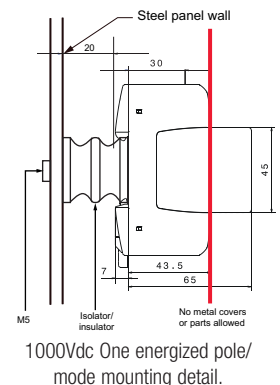
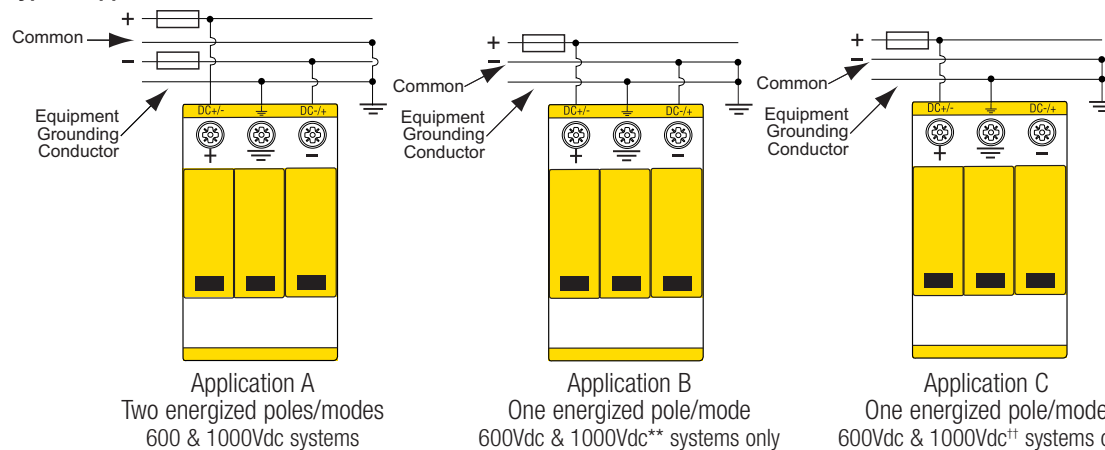

* See Data Sheet 2055 for additional details.

** Surge module may increase the enclosure size requirement, please see factory for specific sizes.

† See Cooper Bussmann SPD Limited Warranty Statement (3A1502) for details at www.cooperbussmann.com/surge.

†† BSPH31000YPV(R) 1000Vdc one energized pole/mode requires the following: 1. Use a suitable electrical insulator to keep a 10mm min. safety distance from the PV-SPD and other grounded parts in the housing as shown. 2. No metal covers are in the area of the module release buttons as shown.

Current Monitoring Device

Features

- Available in standard and disconnect combiner boxes*
- Uses Obvius Solar Current Monitor (SCM) unit
- Unique “Mesh” technology optimizes routing communications with no configuration
- Twisted pair output or wireless communication
- 8 or 16 Input circuit monitoring units
- Monitors 4 to 24 input circuits



Specifications	
Processor	60MHz Arm7 embedded CPU processor
LEDs	3 x RF, 2 x RS 485, 2 x pulse, alive, alarm
Protocol	Modbus RTU
Address Setting	Modbus address may be set from 1 to 247 via DIP switch
Inputs	<ul style="list-style-type: none"> - 2 pulse inputs, dry contact - Monitor consumption/rate/min/max - Pulse rate/width user selectable to 10Hz, 50Hz, 100Hz, or 250Hz. - Pulse rate option: 10Hz, minimum pulse width 50ms - Pulse rate option: 50Hz, minimum pulse width 10ms - Pulse rate option: 100Hz, minimum pulse width 5ms - Pulse rate option: 250Hz, minimum pulse width 2ms - Contact closure threshold 100W to 2.5kW user selectable - Pulse count values are stored in non-volatile memory.
Communications	1 RS-485 (+, -, S), 9600/19200 baud, N, 8, 1, two wire. Supports up to 32 external devices per ModHopper (expandable)
RF	Frequency Hopping, ISM band, -SN Option: 400MHz Receive Only (Sensor Network)
Environmental	North America: Temperature 0° – 50°C, 0 – 95% humidity, non-condensing. Pollution degree 2, altitude up to 2000M
EMC	FCC CFR 47 Part 15, Class A
Size	6.5x4.5x2" (260x64x45mm)
Weight	1.25lbs (0.67 kg)
Power Input	9-30Vdc, 200mA

*Monitoring module may increase the enclosure size requirement, please consult factory for specific sizes.

The only controlled copy of this Data Sheet is the electronic read-only version located on the Cooper Bussmann Network Drive. All other copies of this document are by definition uncontrolled. This bulletin is intended to clearly present comprehensive product data and provide technical information that will help the end user with design applications. Cooper Bussmann reserves the right, without notice, to change design or construction of any products and to discontinue or limit distribution of any products. Cooper Bussmann also reserves the right to change or update, without notice, any technical information contained in this bulletin. Once a product has been selected, it should be tested by the user in all possible applications.