

Tantalum Surface Mount Capacitors

MIL-PRF (CWR Series)



One world. One KEMET.

Electronic Components
KEMET
CHARGED.®

Table of Contents	Page
Why Choose KEMET	3
T409 Series CWR09 Style MIL-PRF-55365/4.....	5
T419 Series CWR19 Style MIL-PRF-55365/11.....	15
T429 Series CWR29 Style MIL-PRF-55365/11.....	26
T492 Series CWR11 Style MIL-PRF-55365/8	38
Packaging Information.....	48
KEMET Corporation Sales Offices	53
Other KEMET Resources	54

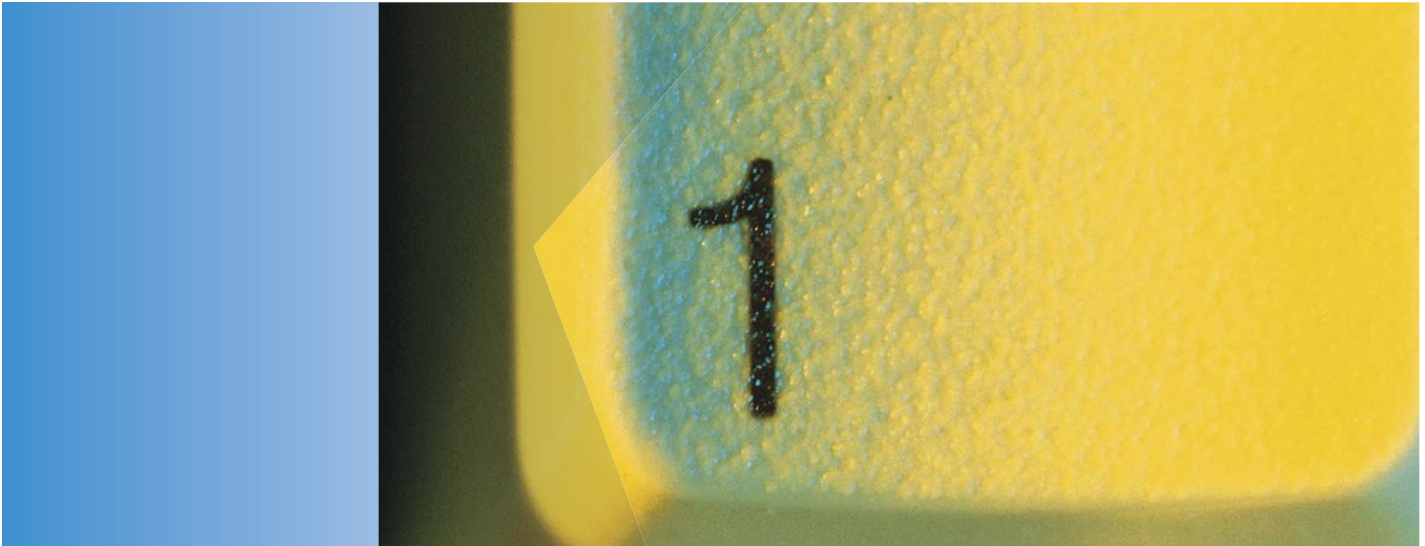

One world. One source. One KEMET.

When you partner with KEMET, our entire global organization provides you with the coordinated service you need. No bouncing from supplier to supplier. No endless phone calls and web browsing. We're your single, integrated source for electronic component solutions worldwide.

Less hassles. More solutions.

Our commitment to product quality and on-time delivery has helped customers succeed for over 90 years. There's a reason KEMET components can be found in defense and aerospace equipment. Our reputation is built on a history of consistency, reliability and service.

The "Easy-to-Buy-From" company.

KEMET offers a level of responsiveness that far surpasses any other supplier. Our passion for customer service is evident throughout our global sales organization, which offers localized support bolstered by our worldwide logistics capabilities. Whether you need rush samples, technical assistance, in-person consultation, accelerated custom design, design collaboration or prototype services, we have a solution.



Made for you.

When you need custom products delivered on a tight schedule, you can trust KEMET. Get direct design consultation from global experts, who help you get the job done on time and within budget.

Working for a better world.

KEMET is dedicated to economically, environmentally and socially sustainable development. We've adopted the Electronic Industry Code of Conduct (EICC) to address all aspects of corporate responsibility. Our manufacturing facilities have won numerous environmental excellence awards and recognitions, and our supply chain is certified. We believe doing the right thing is in everyone's interest.

About KEMET.

KEMET Corporation is a leading global supplier of electronic components. We offer our customers the broadest selection of capacitor technologies in the industry across multiple dielectrics, along with an expanding range of electromechanical devices, and electromagnetic compatibility solutions. Our vision is to be the preferred supplier of electronic component solutions for customers demanding the highest standards of quality, delivery and service.

Overview

The KEMET T409 Series is approved to MIL-PRF-55365/4 (CWR09) with Weibull failure rates of B level (0.1% failures per 1,000 hours), C level (0.01% failures per 1,000 hours), D level (0.001% failures per 1,000 hours), or T level (0.01% failures per 1,000 hours, Option C surge current, DPA, Radiographic

inspection, 100% visual inspection, DCL and ESR measurements within +3 standard deviations, and Group C inspection). This CWR09 product is a precision-molded device with compliant terminations and indelible laser marking. Tape and reeling per EIA 481-1 is standard.

Benefits

- Established reliability options
- Taped and reeled per EIA 481-1
- Symmetrical, compliant terminations
- Laser-marked case
- 100% surge current test available on all case sizes
- Qualified to MIL-PRF-55365/4, Style CWR09
- Termination options B, C, H, K
- Weibull failure options B, C, D, and T
- Exponential failure rates M, P, R, S
- Voltage rating of 4 – 50 VDC
- Operating temperature range of -55°C to +125°C

Applications

Typical applications include decoupling and filtering in Military and aerospace applications requiring CWR09 devices.



Environmental Compliance

RoHS Compliant (6/6) according to Directive 2002/95/EC when ordered with 100% Sn Solder.



RoHS Compliant

SPICE

For a detailed analysis of specific part numbers, please visit www.kemet.com for a free download of KEMET's SPICE software. The KEMET SPICE program is freeware intended to aid design engineers in analyzing the performance of these capacitors over frequency, temperature, ripple, and DC bias conditions.

KEMET Ordering Information

T	409	A	225	K	004	A	H	4252	7280
Capacitor Class	Series	Case Size	Capacitance Code (pF)	Capacitance Tolerance	Voltage	Failure Rate/Design	Lead Material	Surge	Packaging (C-Spec)
T = Tantalum	CWR 09 Established Reliability	A, B, C, D, E, F, G, H, X	First two digits represent significant figures. Third digit specifies number of zeros.	J = ±5% K = ±10% M = ±20%	004 = 4 V 006 = 6.3 V 010 = 10 V 015 = 15 V 020 = 20 V 025 = 25 V 035 = 35 V 050 = 50 V	Weibull A = non-ER B = (0.1%/1,000 hours) C = (0.01%/1,000 hours) D = (0.001%/1,000 hours) T = (0.01%/1,000 hours) Exponential M = (1.0%/1,000 hours) P = (0.1%/1,000 hours) R = (0.01%/1,000 hours) S = (0.001%/1,000 hours)	C = Hot Solder Dipped H = Standard Solder Coated (SnPb 5% Pb minimum) B = Gold Plated K = Solder Fused	4250 = 25°C after Weibull 4251 = -55°C and 85°C after Weibull 4252 = -55°C and 85°C before Weibull TLVL = Weibull Grade Level "T"	Blank = 7" Reel 7280 = 13" Reel 7610 = Bag 7005 = Moisture bags

Defense MIL-PRF-55365/4 Ordering Information

CWR09	J	H	105	K	C	A
Capacitor Style	Voltage	Termination Finish	Capacitance Code (pF)	Capacitance Tolerance	Reliability Level	Surge Current Option
Per MIL-PRF-55365/4	C = 4 V D = 6 V F = 10 V H = 15 V J = 20 V K = 25 V M = 35 V N = 50 V	B = Gold Plated C = Hot solder dipped H = Solder Plated K = Solder fused	First two digits represent significant figures. Third digit specifies number of zeros.	J = ±5% K = ±10% M = ±20%	Weibull A = non-ER B = (0.1%/1,000 hours) C = (0.01%/1,000 hours) D = (0.001%/1,000 hours) T = T Level* (0.01%/1,000 hours) Exponential M = (1.0%/1,000 hours) P = (0.1%/1,000 hours) R = (0.01%/1,000 hours) S = (0.001%/1,000 hours)	A = +25°C after Weibull B = -55°C +85°C after Weibull C = -55°C +85°C before Weibull

* When T Level is ordered, no Surge Current Option is needed

Performance Characteristics

Item	Performance Characteristics
Operating Temperature	-55°C to 125°C
Rated Capacitance Range	0.1 – 100 µF @ 120 Hz/25°C
Capacitance Tolerance	J Tolerance (5%), K Tolerance (10%), M Tolerance (20%)
Rated Voltage Range	4 – 50 V
DF (120 Hz)	Refer to Part Number Electrical Specification Table
ESR (100 kHz)	Refer to Part Number Electrical Specification Table
Leakage Current	≤ 0.01 CV (µA) at rated voltage after 5 minutes

Qualification

Test	Condition	Characteristics					
Endurance	85°C @ rated voltage, 2,000 hours 125°C @ 2/3 rated voltage, 2,000 hours	Δ C/C	Within ±10% of initial value				
		DF	Within initial limits				
		DCL	Within 1.25 x initial limit				
		ESR	Within initial limits				
Storage Life	125°C @ 0 volts, 2,000 hours	Δ C/C	Within ±10% of initial value				
		DF	Within initial limits				
		DCL	Within 1.25 x initial limit				
		ESR	Within initial limits				
Thermal Shock	MIL-STD-202, Method 107, Condition B, mounted, -55°C to 125°C, 1,000 cycles	Δ C/C	Within ±5% of initial value				
		DF	Within initial limits				
		DCL	Within 1.25 x initial limit				
		ESR	Within initial limits				
Temperature Stability	Extreme temperature exposure at a succession of continuous steps at +25°C, -55°C, +25°C, +85°C, +125°C, +25°C	+25°C	-55°C	+85°C	+125°C		
		Δ C/C	IL*	±10%	±10%	±20%	
		DF	IL	IL	1.5 x IL	1.5 x IL	
		DCL	IL	n/a	10 x IL	12 x IL	
		Surge Voltage	25°C and 85°C, 1.32 x rated voltage 1,000 cycles (125°C, 1.2 x rated voltage)	Δ C/C	Within ±5% of initial value		
				DF	Within initial limits		
DCL	Within initial limits						
ESR	Within initial limits						
Mechanical Shock/Vibration	MIL-STD-202, Method 213, Condition I, 100 G peak MIL-STD-202, Method 204, Condition D, 10 Hz to 2,000 Hz, 20 G peak	Δ C/C	Within ±10% of initial value				
		DF	Within initial limits				
		DCL	Within initial limits				
Additional qualification tests per MIL-PRF-55365/4	Please contact KEMET for more information.						

*IL = Initial limit

Certification

MIL-PRF-55365/4

Electrical Characteristics

ESR vs. Frequency

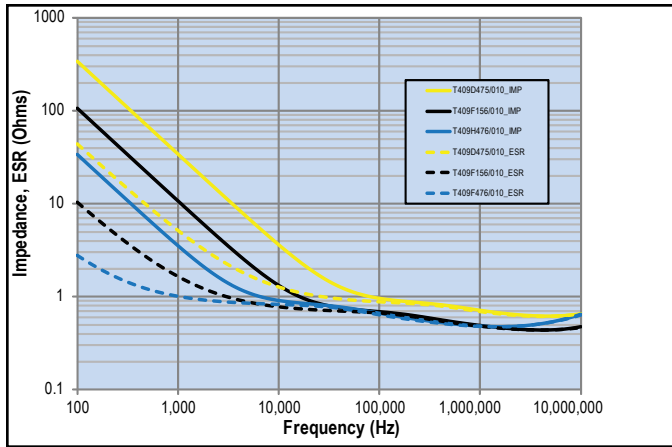

Capacitance vs. Frequency

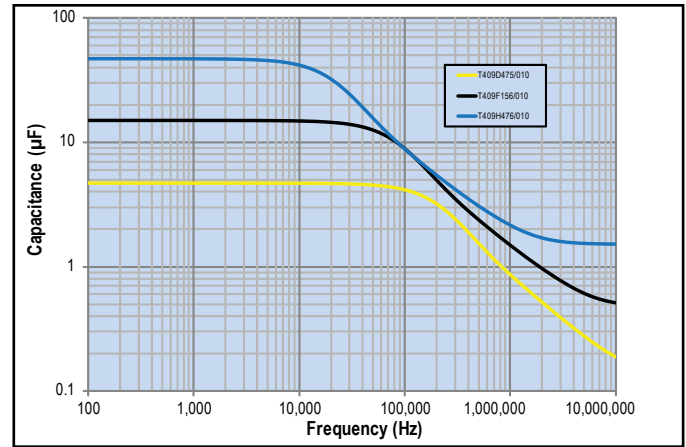

Dimensions – Millimeters (Inches)

Metric will govern

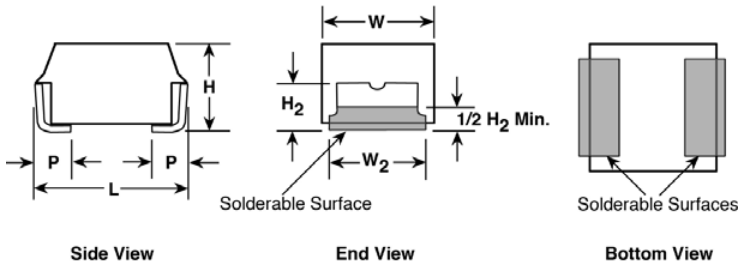

Case Size	Component					
KEMET	$L^* \pm 0.38$ (0.015)	$W^* \pm 0.38$ (0.015)	$H^* \pm 0.38$ (0.015)	$P +0.25$ (0.010), -0.13 (0.005)	W_2	H_2 Minimum
A	2.54 (0.100)	1.27 (0.050)	1.27 (0.050)	0.76 (0.030)	1.27 ± 0.13 (0.050 \pm 0.005)	0.76 (0.030)
B	3.81 (0.150)	1.27 (0.050)	1.27 (0.050)	0.76 (0.030)	1.27 ± 0.13 (0.050 \pm 0.005)	0.76 (0.030)
C	5.08 (0.200)	1.27 (0.050)	1.27 (0.050)	0.76 (0.030)	1.27 ± 0.13 (0.050 \pm 0.005)	0.76 (0.030)
D	3.81 (0.150)	2.54 (0.100)	1.27 (0.050)	0.76 (0.030)	$2.41 +0.13, -0.25$ (0.095 \pm 0.005, -0.010)	0.76 (0.030)
E	5.08 (0.200)	2.54 (0.100)	1.27 (0.050)	0.76 (0.030)	$2.41 +0.13, -0.25$ (0.095 \pm 0.005, -0.010)	0.76 (0.030)
F	5.59 (0.220)	3.43 (0.135)	1.78 (0.070)	0.76 (0.030)	3.30 ± 0.13 (0.130 \pm 0.005)	1.02 (0.040)
G	6.73 (0.265)	2.79 (0.110)	2.79 (0.110)	1.27 (0.050)	2.67 ± 0.13 (0.105 \pm 0.005)	1.52 (0.060)
H	7.24 (0.285)	3.81 (0.150)	2.79 (0.110)	1.27 (0.050)	$3.68 +0.013, -0.51$ (0.145 \pm 0.005, -0.020)	1.52 (0.060)

Note: When solder coated terminations are required, add an additional 0.38 mm (0.015 inch) to the above tolerances for "L", "W", "H", "P", "W₂" and "H₂"

Table 1 – Ratings & Part Number Reference

Rated Voltage	Rated Cap	Case Code/ Case Size	KEMET Part Number	MIL-PRF–55365/4 Part Number	DC Leakage	DF	ESR	Moisture Sensitivity
V	µF	KEMET/EIA	(See below for part options)	(See below for part options)	µA @ +20°C Maximum/5 Minutes	% @ +20°C 120 Hz Maximum	Ω @ +20°C 100 kHz Maximum	Reflow Temperature ≤ 260°C
4	2.2	A/1005	T409A225(1)004(2)(3)(4)	CWR09C(3)225(1)(2)(5)	1	6.0	8.0	1
4	4.7	B/1505	T409B475(1)004(2)(3)(4)	CWR09C(3)475(1)(2)(5)	1.0	6.0	8.0	1
4	6.8	C/2005	T409C685(1)004(2)(3)(4)	CWR09C(3)685(1)(2)(5)	1.0	6.0	5.5	1
4	10	D/1510	T409D106(1)004(2)(3)(4)	CWR09C(3)106(1)(2)(5)	1.0	8.0	4.0	1
4	15	E/2010	T409E156(1)004(2)(3)(4)	CWR09C(3)156(1)(2)(5)	1.0	8.0	3.5	1
4	33	F/2214	T409F336(1)004(2)(3)(4)	CWR09C(3)336(1)(2)(5)	2.0	8.0	2.2	1
4	68	G/2711	T409G686(1)004(2)(3)(4)	CWR09C(3)686(1)(2)(5)	3.0	10.0	1.1	1
4	100	H/2915	T409H107(1)004(2)(3)(4)	CWR09C(3)107(1)(2)(5)	4.0	10.0	0.9	1
6	1.5	A/1005	T409A155(1)006(2)(3)(4)	CWR09D(3)155(1)(2)(5)	1.0	6.0	8.0	1
6	3.3	B/1505	T409B335(1)006(2)(3)(4)	CWR09D(3)335(1)(2)(5)	1.0	6.0	8.0	1
6	4.7	C/2005	T409C475(1)006(2)(3)(4)	CWR09D(3)475(1)(2)(5)	1.0	6.0	5.5	1
6	6.8	D/1510	T409D685(1)006(2)(3)(4)	CWR09D(3)685(1)(2)(5)	1.0	6.0	4.5	1
6	10	E/2010	T409E106(1)006(2)(3)(4)	CWR09D(3)106(1)(2)(5)	1.0	8.0	3.5	1
6	22	F/2214	T409F226(1)006(2)(3)(4)	CWR09D(3)226(1)(2)(5)	2.0	8.0	2.2	1
6	47	G/2711	T409G476(1)006(2)(3)(4)	CWR09D(3)476(1)(2)(5)	3.0	10.0	1.1	1
6	68	H/2915	T409H686(1)006(2)(3)(4)	CWR09D(3)686(1)(2)(5)	4.0	10.0	0.9	1
10	1	A/1005	T409A105(1)010(2)(3)(4)	CWR09F(3)105(1)(2)(5)	1.0	6.0	10.0	1
10	2.2	B/1505	T409B225(1)010(2)(3)(4)	CWR09F(3)225(1)(2)(5)	1.0	6.0	8.0	1
10	3.3	C/2005	T409C335(1)010(2)(3)(4)	CWR09F(3)335(1)(2)(5)	1.0	6.0	5.5	1
10	4.7	D/1510	T409D475(1)010(2)(3)(4)	CWR09F(3)475(1)(2)(5)	1.0	6.0	4.5	1
10	6.8	E/2010	T409E685(1)010(2)(3)(4)	CWR09F(3)685(1)(2)(5)	1.0	6.0	3.5	1
10	15	F/2214	T409F156(1)010(2)(3)(4)	CWR09F(3)156(1)(2)(5)	2.0	8.0	2.5	1
10	33	G/2711	T409G336(1)010(2)(3)(4)	CWR09F(3)336(1)(2)(5)	3.0	10.0	1.1	1
10	47	H/2915	T409H476(1)010(2)(3)(4)	CWR09F(3)476(1)(2)(5)	5.0	10.0	0.9	1
15	0.68	A/1005	T409A684(1)015(2)(3)(4)	CWR09H(3)684(1)(2)(5)	1.0	6.0	12.0	1
15	1.5	B/1505	T409B155(1)015(2)(3)(4)	CWR09H(3)155(1)(2)(5)	1.0	6.0	8.0	1
15	2.2	C/2005	T409C225(1)015(2)(3)(4)	CWR09H(3)225(1)(2)(5)	1.0	6.0	5.5	1
15	3.3	D/1510	T409D335(1)015(2)(3)(4)	CWR09H(3)335(1)(2)(5)	1.0	6.0	5.0	1
15	4.7	E/2010	T409E475(1)015(2)(3)(4)	CWR09H(3)475(1)(2)(5)	1.0	6.0	4.0	1
15	10	F/2214	T409F106(1)015(2)(3)(4)	CWR09H(3)106(1)(2)(5)	2.0	6.0	2.5	1
15	22	G/2711	T409G226(1)015(2)(3)(4)	CWR09H(3)226(1)(2)(5)	4.0	6.0	1.1	1
15	33	H/2915	T409H336(1)015(2)(3)(4)	CWR09H(3)336(1)(2)(5)	5.0	8.0	0.9	1
20	0.47	A/1005	T409A474(1)020(2)(3)(4)	CWR09J(3)474(1)(2)(5)	1.0	8.0	14.0	1
20	0.68	B/1505	T409B684(1)020(2)(3)(4)	CWR09J(3)684(1)(2)(5)	1.0	6.0	10.0	1
20	1	B/1505	T409B105(1)020(2)(3)(4)	CWR09J(3)105(1)(2)(5)	1.0	6.0	12.0	1
20	1.5	C/2005	T409C155(1)020(2)(3)(4)	CWR09J(3)155(1)(2)(5)	1.0	6.0	6.0	1
20	2.2	D/1510	T409D225(1)020(2)(3)(4)	CWR09J(3)225(1)(2)(5)	1.0	6.0	5.0	1
20	3.3	E/2010	T409E335(1)020(2)(3)(4)	CWR09J(3)335(1)(2)(5)	1.0	6.0	4.0	1
20	6.8	F/2214	T409F685(1)020(2)(3)(4)	CWR09J(3)685(1)(2)(5)	2.0	6.0	2.4	1
20	15	G/2711	T409G156(1)020(2)(3)(4)	CWR09J(3)156(1)(2)(5)	3.0	6.0	1.1	1
20	22	H/2915	T409H226(1)020(2)(3)(4)	CWR09J(3)226(1)(2)(5)	4.0	6.0	0.9	1
25	0.33	A/1005	T409A334(1)025(2)(3)(4)	CWR09K(3)334(1)(2)(5)	1.0	6.0	15.0	1
25	0.68	B/1505	T409B684(1)025(2)(3)(4)	CWR09K(3)684(1)(2)(5)	1.0	6.0	7.5	1
25	1	C/2005	T409C105(1)025(2)(3)(4)	CWR09K(3)105(1)(2)(5)	1.0	6.0	6.5	1
25	1.5	D/1510	T409D155(1)025(2)(3)(4)	CWR09K(3)155(1)(2)(5)	1.0	6.0	6.5	1
25	2.2	E/2010	T409E225(1)025(2)(3)(4)	CWR09K(3)225(1)(2)(5)	1.0	6.0	3.5	1
25	4.7	F/2214	T409F475(1)025(2)(3)(4)	CWR09K(3)475(1)(2)(5)	2.0	6.0	2.5	1
25	6.8	G/2711	T409G685(1)025(2)(3)(4)	CWR09K(3)685(1)(2)(5)	2.0	6.0	1.2	1
V	µF	KEMET/EIA	(See below for part options)	(See below for part options)	µA @ +20°C Maximum/5 Minutes	% @ +20°C 120 Hz Maximum	Ω @ +20°C 100 kHz Maximum	Reflow Temperature ≤ 260°C
Rated Voltage	Rated Cap	Case Code/ Case Size	KEMET Part Number	MIL-PRF-55365/4 Part Number	DC Leakage	DF	ESR	Moisture Sensitivity

(1) To complete KEMET/CWR part number, insert M for ±20%, K for ±10%, or J for ±5%. Designates capacitance tolerance.

(2) To complete KEMET/CWR part number, insert B (0.1%/1,000 Hours), C (0.01%/1,000 Hours), D (0.001%/1,000 Hours) or A = N/A. Designates reliability level.

(3) To complete KEMET/CWR part number, insert B = Gold Plated, C = Hot solder dipped, H = Solder plated or K = Solder Fused. Designates termination finish.

(4) To complete KEMET part number, insert 4250 = +25°C after Weibull, 4251 = -55°C +85°C after Weibull, or 4252 = -55°C +85°C before Weibull. Designates surge current option.

(5) To complete CWR part number, insert A = +25°C after Weibull, B = -55°C +85°C after Weibull, or C = -55°C +85°C before Weibull. Designates surge current option. Refer to Ordering Information for additional detail.

Table 1 – Ratings & Part Number Reference cont'd

Rated Voltage	Rated Cap	Case Code/ Case Size	KEMET Part Number	MIL-PRF-55365/4 Part Number	DC Leakage	DF	ESR	Moisture Sensitivity
V	µF	KEMET/EIA	(See below for part options)	(See below for part options)	µA @ +20°C Maximum/5 Minutes	% @ +20°C 120 Hz Maximum	Ω @ +20°C 100 kHz Maximum	Reflow Temperature ≤ 260°C
25	10	G/2711	T409G106(1)025(2)(3)(4)	CWR09K(3)106(1)(2)(5)	3.0	6.0	1.4	1
25	15	H/2915	T409H156(1)025(2)(3)(4)	CWR09K(3)156(1)(2)(5)	4.0	6.0	1.0	1
35	0.22	A/1005	T409A224(1)035(2)(3)(4)	CWR09M(3)224(1)(2)(5)	1.0	6.0	18.0	1
35	0.47	B/1505	T409B474(1)035(2)(3)(4)	CWR09M(3)474(1)(2)(5)	1.0	6.0	10.0	1
35	0.68	C/2005	T409C684(1)035(2)(3)(4)	CWR09M(3)684(1)(2)(5)	1.0	6.0	8.0	1
35	1	D/1510	T409D105(1)035(2)(3)(4)	CWR09M(3)105(1)(2)(5)	1.0	6.0	6.5	1
35	1.5	E/2010	T409E155(1)035(2)(3)(4)	CWR09M(3)155(1)(2)(5)	1.0	6.0	4.5	1
35	3.3	F/2214	T409F335(1)035(2)(3)(4)	CWR09M(3)335(1)(2)(5)	1.0	6.0	2.5	1
35	4.7	G/2711	T409G475(1)035(2)(3)(4)	CWR09M(3)475(1)(2)(5)	2.0	6.0	1.5	1
35	6.8	H/2915	T409H685(1)035(2)(3)(4)	CWR09M(3)685(1)(2)(5)	3.0	6.0	1.3	1
50	0.1	A/1005	T409A104(1)050(2)(3)(4)	CWR09N(3)104(1)(2)(5)	1.0	6.0	22.0	1
50	0.15	A/1005	T409A154(1)050(2)(3)(4)	CWR09N(3)154(1)(2)(5)	1.0	6.0	17.0	1
50	0.22	B/1505	T409B224(1)050(2)(3)(4)	CWR09N(3)224(1)(2)(5)	1.0	6.0	14.0	1
50	0.33	B/1505	T409B334(1)050(2)(3)(4)	CWR09N(3)334(1)(2)(5)	1.0	6.0	12.0	1
50	0.47	C/2005	T409C474(1)050(2)(3)(4)	CWR09N(3)474(1)(2)(5)	1.0	6.0	8.0	1
50	0.68	D/1510	T409D684(1)050(2)(3)(4)	CWR09N(3)684(1)(2)(5)	1.0	6.0	7.0	1
50	1	E/2010	T409E105(1)050(2)(3)(4)	CWR09N(3)105(1)(2)(5)	1.0	6.0	6.0	1
50	1.5	F/2214	T409F155(1)050(2)(3)(4)	CWR09N(3)155(1)(2)(5)	1.0	6.0	4.0	1
50	2.2	F/2214	T409F225(1)050(2)(3)(4)	CWR09N(3)225(1)(2)(5)	2.0	6.0	2.5	1
50	3.3	G/2711	T409G335(1)050(2)(3)(4)	CWR09N(3)335(1)(2)(5)	2.0	6.0	2.0	1
50	4.7	H/2915	T409H475(1)050(2)(3)(4)	CWR09N(3)475(1)(2)(5)	3.0	6.0	1.5	1
V	µF	KEMET/EIA	(See below for part options)	(See below for part options)	µA @ +20°C Maximum/5 Minutes	% @ +20°C 120 Hz Maximum	Ω @ +20°C 100 kHz Maximum	Reflow Temperature ≤ 260°C
Rated Voltage	Rated Cap	Case Code/ Case Size	KEMET Part Number	MIL-PRF-55365/4 Part Number	DC Leakage	DF	ESR	Moisture Sensitivity

(1) To complete KEMET/CWR part number, insert M for ±20%, K for ±10%, or J for ±5%. Designates capacitance tolerance.

(2) To complete KEMET/CWR part number, insert failure rate letter per the Ordering Information found on page 2. Designates Reliability Level.

(3) To complete KEMET/CWR part number, insert B = Gold Plated, C = Hot solder dipped, H = Solder plated or K = Solder Fused. Designates termination finish.

(4) To complete KEMET part number, insert 4250 = +25°C after Weibull, 4251 = -55°C +85°C after Weibull, or 4252 = -55°C +85°C before Weibull. Designates surge current option.

(5) To complete CWR part number, insert A = +25°C after Weibull, B = -55°C +85°C after Weibull, or C = -55°C +85°C before Weibull. Designates surge current option. Refer to Ordering Information for additional detail.

Recommended Voltage Derating Guidelines

	-55°C to 85°C	85°C to 125°C
% Change in Working DC Voltage with Temperature	V_R	67% of V_R
Recommended Maximum Application Voltage	50% of V_R	33% of V_R

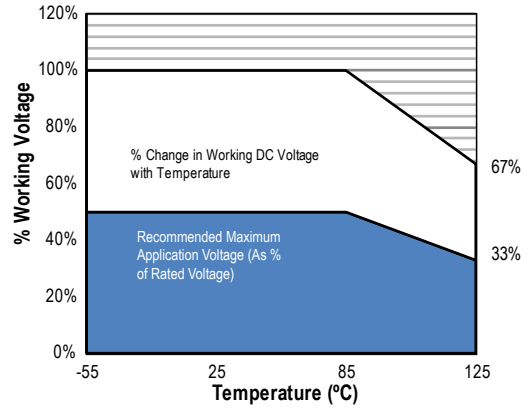

Ripple Current/Ripple Voltage

Permissible AC ripple voltage and current are related to equivalent series resistance (ESR) and the power dissipation capabilities of the device. Permissible AC ripple voltage which may be applied is limited by two criteria:

1. The positive peak AC voltage plus the DC bias voltage, if any, must not exceed the DC voltage rating of the capacitor.
2. The negative peak AC voltage in combination with bias voltage, if any, must not exceed the allowable limits specified for reverse voltage. See the Reverse Voltage section for allowable limits.

The maximum power dissipation by case size can be determined using the table at right. The maximum power dissipation rating stated in the table must be reduced with increasing environmental operating temperatures. Refer to the table below for temperature compensation requirements.

KEMET Case Code	EIA Case Code	Maximum Power Dissipation (P max) mWatts @ 25°C w/+20°C Rise
A	1005	50
B	1505	70
C	2005	75
D	1510	80
E	2010	90
F	2214	100
G	2711	125
H	2915	150

The maximum power dissipation rating must be reduced with increasing environmental operating temperatures. Refer to the Temperature Compensation Multiplier table for details.

Temperature Compensation Multipliers for Maximum Power Dissipation		
T ≤ 25°C	T ≤ 85°C	T ≤ 125°C
1.00	0.90	0.40

T= Environmental Temperature

Using the P max of the device, the maximum allowable rms ripple current or voltage may be determined.

$$I(max) = \sqrt{P_{max}/R}$$

$$E(max) = Z \sqrt{P_{max}/R}$$

I = rms ripple current (amperes)

R = ESR at specified frequency (ohms)

E = rms ripple voltage (volts)

Z = Impedance at specified frequency (ohms)

P max = maximum power dissipation (watts)

Reverse Voltage

Solid tantalum capacitors are polar devices and may be permanently damaged or destroyed if connected with the wrong polarity. The positive terminal is identified on the capacitor body by a stripe plus in some cases a beveled edge. A small degree of transient reverse voltage is permissible for short periods per the table. The capacitors should not be operated continuously in reverse mode, even within these limits.

Temperature	Permissible Transient Reverse Voltage
25°C	15% of Rated Voltage
85°C	5% of Rated Voltage
125°C	1% of Rated Voltage

Table 2 – Land Dimensions/Courtyard

KEMET	Metric Size Code	Density Level A: Maximum (Most) Land Protrusion (mm)					Density Level B: Median (Nominal) Land Protrusion (mm)					Density Level C: Minimum (Least) Land Protrusion (mm)				
		L	W	S	V1	V2	L	W	S	V1	V2	L	W	S	V1	V2
A ¹	1005	2.19	1.44	0.15	5.54	2.66	1.89	1.32	0.15	4.44	2.16	1.52	1.22	0.29	3.58	1.90
B	1505	2.30	1.44	1.20	6.80	2.66	1.90	1.32	1.40	5.70	2.16	1.52	1.22	1.56	4.84	1.90
C	2005	2.30	1.44	2.47	8.08	2.66	1.90	1.32	2.67	6.98	2.16	1.52	1.22	2.83	6.12	1.90
D	1510	2.30	2.58	1.20	6.80	3.92	1.90	2.46	1.40	5.70	3.42	1.52	2.36	1.56	4.84	3.16
E	2010	2.30	2.58	2.47	8.08	3.92	1.90	2.46	2.67	6.98	3.42	1.52	2.36	2.83	6.12	3.16
F	2214	2.30	3.47	2.98	8.58	4.82	1.90	3.35	3.18	7.48	4.32	1.52	3.25	3.34	6.62	4.06
G	2711	2.81	2.84	3.10	9.72	4.18	2.41	2.72	3.30	8.62	3.68	2.03	2.62	3.46	7.76	3.42
H	2915	2.81	3.84	3.61	10.24	5.20	2.41	3.72	3.81	9.14	4.70	2.03	3.62	3.97	8.28	4.44
X	2824	2.73	3.22	3.46	9.92	6.80	2.33	3.10	3.66	8.82	6.30	1.95	3.00	3.82	7.96	6.04

Density Level A: For low-density product applications. Recommended for wave solder applications and provides a wider process window for reflow solder processes.

Density Level B: For products with a moderate level of component density. Provides a robust solder attachment condition for reflow solder processes.

Density Level C: For high component density product applications. Before adapting the minimum land pattern variations the user should perform qualification testing based on the conditions outlined in IPC standard 7351 (IPC-7351).

¹ Land pattern geometry is too small for silkscreen outline.

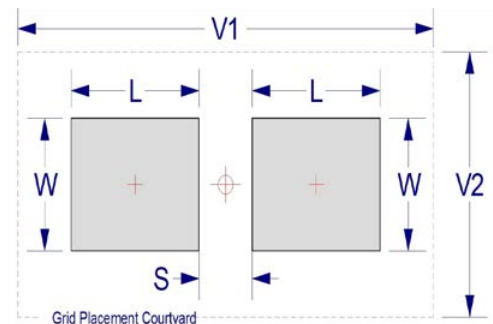

Soldering Process

KEMET’s families of surface mount capacitors are compatible with wave (single or dual), convection, IR, or vapor phase reflow techniques. Preheating of these components is recommended to avoid extreme thermal stress. KEMET’s recommended profile conditions for convection and IR reflow reflect the profile conditions of the IPC/J-STD-020D standard for moisture sensitivity testing. The devices can safely withstand a maximum of three reflow passes at these conditions.

Note that although the X/7343-43 case size can withstand wave soldering, the tall profile (4.3 mm maximum) dictates care in wave process development.

Hand soldering should be performed with care due to the difficulty in process control. If performed, care should be taken to avoid contact of the soldering iron to the molded case. The iron should be used to heat the solder pad, applying solder between the pad and the termination, until reflow occurs. Once reflow occurs, the iron should be removed immediately. “Wiping” the edges of a chip and heating the top surface is not recommended.

During typical reflow operations, a slight darkening of the gold-colored epoxy may be observed. This slight darkening is normal and not harmful to the product. Marking permanency is not affected by this change.

Profile Feature	SnPb Assembly	Pb-Free Assembly
Preheat/Soak		
Temperature Minimum (T_{Smin})	100°C	150°C
Temperature Maximum (T_{Smax})	150°C	200°C
Time (t_s) from T_{Smin} to T_{Smax}	60 – 120 seconds	60 – 120 seconds
Ramp-up Rate (T_L to T_P)	3°C/seconds maximum	3°C/seconds maximum
Liquidous Temperature (T_L)	183°C	217°C
Time Above Liquidous (t_L)	60 – 150 seconds	60 – 150 seconds
Peak Temperature (T_P)	220°C* 235°C**	250°C* 260°C**
Time within 5°C of Maximum Peak Temperature (t_p)	20 seconds maximum	30 seconds maximum
Ramp-down Rate (T_P to T_L)	6°C/seconds maximum	6°C/seconds maximum
Time 25°C to Peak Temperature	6 minutes maximum	8 minutes maximum

Note: All temperatures refer to the center of the package, measured on the package body surface that is facing up during assembly reflow.

*Case Size D, E, P, Y, and X

**Case Size A, B, C, H, I, K, M, R, S, T, U, V, W, and Z

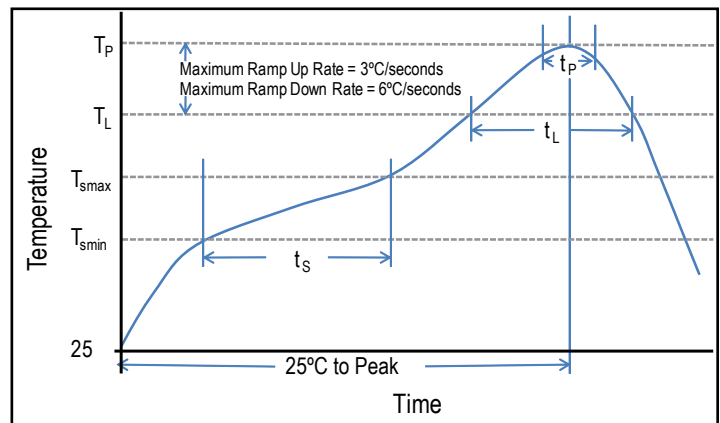

Construction

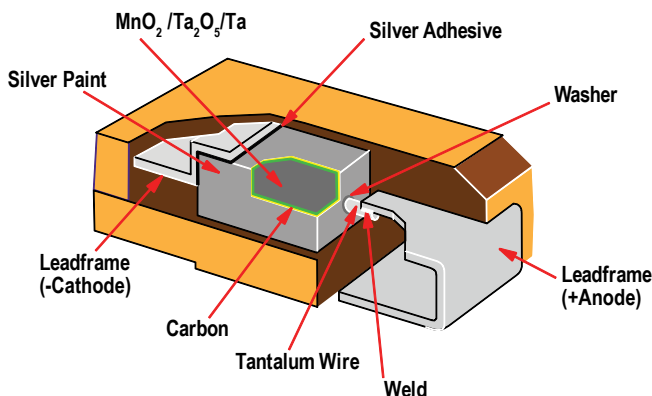

Capacitor Marking

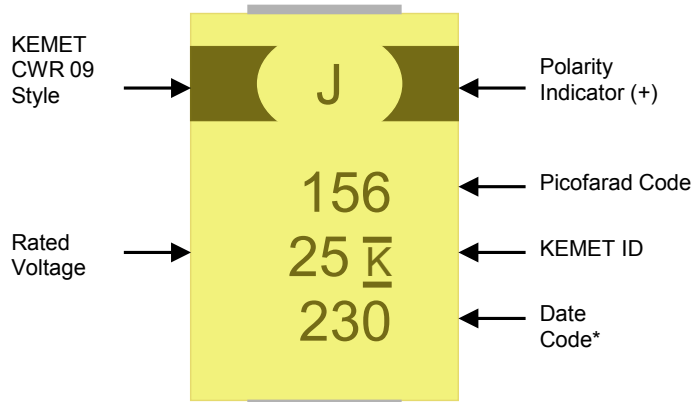

* 230 = 30th week of 2012

Date Code *	
1 st digit = Last number of Year	9 = 2009 0 = 2010 1 = 2011 2 = 2012 3 = 2013 4 = 2014
2 nd and 3 rd digit = Week of the Year	01 = 1 st week of the Year to 52 = 52 nd week of the Year

Storage

Tantalum chip capacitors should be stored in normal working environments. While the chips themselves are quite robust in other environments, solderability will be degraded by exposure to high temperatures, high humidity, corrosive atmospheres, and long term storage. In addition, packaging materials will be degraded by high temperature– reels may soften or warp and tape peel force may increase. KEMET recommends that maximum storage temperature not exceed 40°C and maximum storage humidity not exceed 60% relative humidity. Temperature fluctuations should be minimized to avoid condensation on the parts and atmospheres should be free of chlorine and sulphur bearing compounds. For optimized solderability chip stock should be used promptly, preferably within three years of receipt.

Overview

The KEMET T419 Series is approved to MIL-PRF-55365/11 (CWR19) with Weibull failure rates of B level (0.1% failures per 1,000 hours), C level (0.01% failures per 1,000 hours), D level (0.001% failures per 1,000 hours), or T level (0.01% failures per 1,000 hours), Option C surge current, DPA, Radiographic

inspection, 100% visual inspection, DCL and ESR measurements within +3 standard deviations, and Group C inspection). This CWR19 product is a precision-molded device with compliant terminations and indelible laser marking. Tape and reeling per EIA 481-1 is standard.

Benefits

- Established reliability options
- Taped and reeled per EIA 481-1
- Symmetrical, compliant terminations
- Laser-marked case
- 100% surge current test available on all case sizes
- Qualified to MIL-PRF-55365/11, Style CWR19
- Termination options B, C, H, K
- Weibull failure options B, C, D, and T
- Exponential failure rates M, P, R, S
- Voltage rating of 4 – 35 VDC
- Operating temperature range of -55°C to +125°C

Applications

Typical applications include decoupling and filtering in Military and aerospace applications requiring CWR19 devices.



Environmental Compliance

RoHS Compliant (6/6) according to Directive 2002/95/EC when ordered with 100% Sn Solder.



RoHS Compliant

SPICE

For a detailed analysis of specific part numbers, please visit www.kemet.com for a free download of KEMET's SPICE software. The KEMET SPICE program is freeware intended to aid design engineers in analyzing the performance of these capacitors over frequency, temperature, ripple, and DC bias conditions.

KEMET Ordering Information

T	419	A	225	K	004	A	H	4251	7280
Capacitor Class	Series	Case Size	Capacitance Code (pF)	Capacitance Tolerance	Voltage	Failure Rate/Design	Lead Material	Surge	Packaging (C-Spec)
T = Tantalum	CWR19 Established Reliability	A, B, C, D, E, F, G, H, X	First two digits represent significant figures. Third digit specifies number of zeros.	J = ±5% K = ±10% M = ±20%	004 = 4 V 006 = 6.3 V 010 = 10 V 015 = 15 V 020 = 20 V 025 = 25 V 035 = 35 V	Weibull A = non-ER B = (0.1%/1,000 hours) C = (0.01%/1,000 hours) D = (0.001%/1,000 hours) T = (0.01%/1,000 hours) Exponential M = (1.0%/1,000 hours) P = (0.1%/1,000 hours) R = (0.01%/1,000 hours) S = (0.001%/1,000 hours)	C = Hot Solder Dipped H = Standard Solder Coated (SnPb 5% Pb minimum) B = Gold Plated K = Solder Fused	Blank = No Surge 4250 = 25°C after Weibull 4251 = -55°C and 85°C after Weibull 4252 = -55°C and 85°C before Weibull TLVL = Weibull Grade Level "T"	Blank = 7" Reel 7280 = 13" Reel 7610 = Bag 7005 = Moisture bags

Defense MIL-PRF-55365/11 Ordering Information

CWR19	K	H	225	K	C	D	A
Capacitor Style	Voltage	Termination Finish	Capacitance Code (pF)	Capacitance Tolerance	Reliability Level	Case Code	Surge Current Option
Per MIL-PRF-55365/11	C = 4 V D = 6 V F = 10 V H = 15 V J = 20 V K = 25 V M = 35 V	B = Gold Plated C = Hot solder dipped H = Solder Plated K = Solder fused	First two digits represent significant figures. Third digit specifies number of zeros.	J = ±5% K = ±10% M = ±20%	Weibull A = non-ER B = (0.1%/1,000 hours) C = (0.01%/1,000 hours) D = (0.001%/1,000 hours) T = T Level* (0.01%/1,000 hours) Exponential M = (1.0%/1,000 hours) P = (0.1%/1,000 hours) R = (0.01%/1,000 hours) S = (0.001%/1,000 hours)	A, B, C, D, E, F, G, H, X	A = +25°C after Weibull B = -55°C +85°C after Weibull C = -55°C +85°C before Weibull Z = None

* When T Level is ordered, no Surge Current Option is needed

Performance Characteristics

Item	Performance Characteristics
Operating Temperature	-55°C to 125°C
Rated Capacitance Range	0.33 – 330 µF @ 120 Hz/25°C
Capacitance Tolerance	J Tolerance (5%), K Tolerance (10%), M Tolerance (20%)
Rated Voltage Range	4 – 35 V
DF (120 Hz)	Refer to Part Number Electrical Specification Table
ESR (100 kHz)	Refer to Part Number Electrical Specification Table
Leakage Current	≤ 0.01 CV (µA) at rated voltage after 5 minutes

Qualification

Test	Condition	Characteristics					
Endurance	85°C @ rated voltage, 2,000 hours 125°C @ 2/3 rated voltage, 2,000 hours	Δ C/C	Within ±10% of initial value				
		DF	Within initial limits				
		DCL	Within 1.25 x initial limit				
		ESR	Within initial limits				
Storage Life	125°C @ 0 volts, 2,000 hours	Δ C/C	Within ±10% of initial value				
		DF	Within initial limits				
		DCL	Within 1.25 x initial limit				
		ESR	Within initial limits				
Thermal Shock	MIL-STD-202, Method 107, Condition B, mounted, -55°C to 125°C, 1,000 cycles	Δ C/C	Within ±5% of initial value				
		DF	Within initial limits				
		DCL	Within 1.25 x initial limit				
		ESR	Within initial limits				
Temperature Stability	Extreme temperature exposure at a succession of continuous steps at +25°C, -55°C, +25°C, +85°C, +125°C, +25°C	+25°C	-55°C	+85°C	+125°C		
		Δ C/C	IL*	±10%	±10%	±20%	
		DF	IL	IL	1.5 x IL	1.5 x IL	
		DCL	IL	n/a	10 x IL	12 x IL	
		Surge Voltage	25°C and 85°C, 1.32 x rated voltage 1,000 cycles (125°C, 1.2 x rated voltage)	Δ C/C	Within ±5% of initial value		
				DF	Within initial limits		
DCL	Within initial limits						
ESR	Within initial limits						
Mechanical Shock/Vibration	MIL-STD-202, Method 213, Condition I, 100 G Peak MIL-STD-202, Method 204, Condition D, 10 Hz to 2,000 Hz, 20 G peak	Δ C/C	Within ±10% of initial value				
		DF	Within initial limits				
		DCL	Within initial limits				
Additional qualification tests per MIL-PRF-55365/11	Please contact KEMET for more information.						

*IL = Initial limit

Certification

MIL-PRF-55365/11

Electrical Characteristics

ESR vs. Frequency

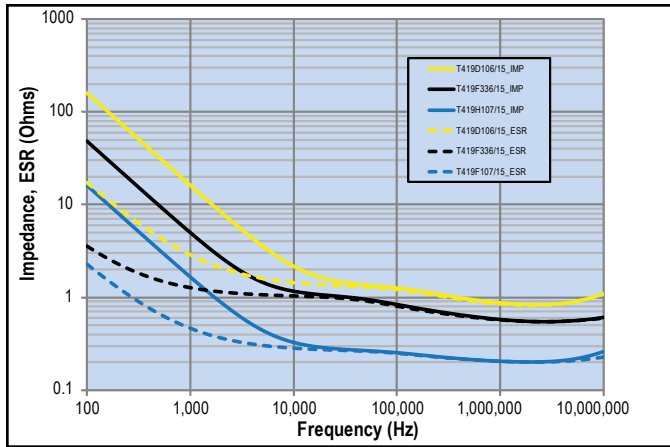

Capacitance vs. Frequency

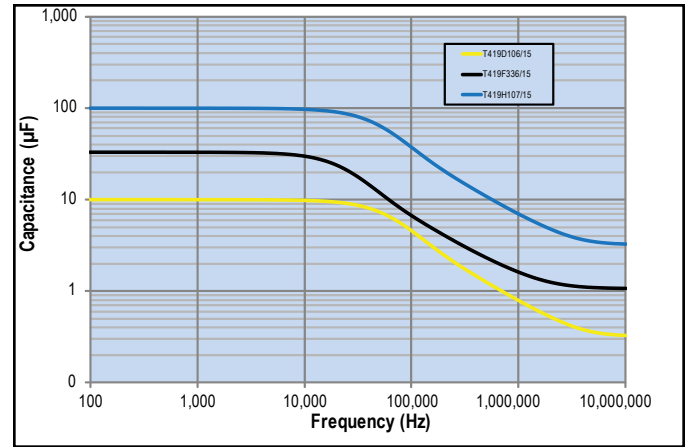

Dimensions – Millimeters (Inches)

Metric will govern

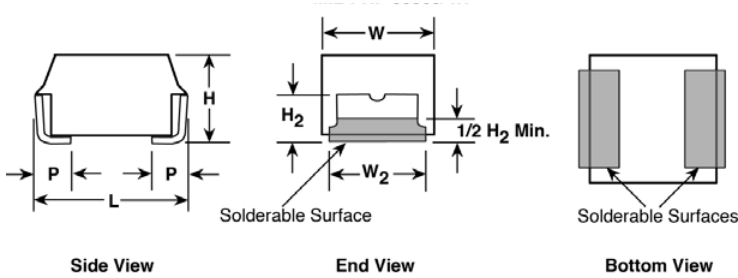

Case Size	Component					
KEMET	L* ±0.38 (0.015)	W* ±0.38 (0.015)	H* ±0.38 (0.015)	P +0.25 (0.010), -0.13 (0.005)	W ₂	H ₂ Minimum
A	2.54 (0.100)	1.27 (0.050)	1.27 (0.050)	0.76 (0.030)	1.27 ±0.13 (0.050 ±0.005)	0.76 (0.030)
B	3.81 (0.150)	1.27 (0.050)	1.27 (0.050)	0.76 (0.030)	1.27 ±0.13 (0.050 ±0.005)	0.76 (0.030)
C	5.08 (0.200)	1.27 (0.050)	1.27 (0.050)	0.76 (0.030)	1.27 ±0.13 (0.050 ±0.005)	0.76 (0.030)
D	3.81 (0.150)	2.54 (0.100)	1.27 (0.050)	0.76 (0.030)	2.41 +0.13, -0.25 (0.095 +0.005, -0.010)	0.76 (0.030)
E	5.08 (0.200)	2.54 (0.100)	1.27 (0.050)	0.76 (0.030)	2.41 +0.13, -0.25 (0.095 +0.005, -0.010)	0.76 (0.030)
F	5.59 (0.220)	3.43 (0.135)	1.78 (0.070)	0.76 (0.030)	3.30 ±0.13 (0.130 ±0.005)	1.02 (0.040)
G	6.73 (0.265)	2.79 (0.110)	2.79 (0.110)	1.27 (0.050)	2.67 ±0.13 (0.105 ±0.005)	1.52 (0.060)
H	7.24 (0.285)	3.81 (0.150)	2.79 (0.110)	1.27 (0.050)	3.68 +0.013, -0.51 (0.145 +0.005, -0.020)	1.52 (0.060)
X	6.93 (0.273)	5.41 (0.213)	2.74 (0.108)	1.19 (0.047)	3.05 ±0.13 (0.120 ±0.005)	1.22 (0.048)

Note: When solder coated terminations are required, add an additional 0.38 mm (0.015 inch) to the above tolerances for "L", "W", "H", "P", "W₂" and "H₂"

Table 1 – Ratings & Part Number Reference

Rated Voltage	Rated Cap	Case Code/ Case Size	KEMET Part Number	MIL-PRF-55365/11 Part Number	DC Leakage	DF	ESR	Moisture Sensitivity
VDC	µF	KEMET/EIA	(See below for part options)	(See below for part options)	µA @ +20°C Max/5 Min	% @ 20°C 120 Hz Max	Ω @ +20°C 100kHz Max	Reflow Temperature ≤ 260°C
4	3.3	A/1005	T419A335(1)004(2)(3)(4)	CWR19C(3)335(1)(2)A(5)	1.0	6.0	12.0	1
4	4.7	A/1005	T419A475(1)004(2)(3)(4)	CWR19C(3)475(1)(2)A(5)	1.0	6.0	12.0	1
4	6.8	A/1005	T419A685(1)004(2)(3)(4)	CWR19C(3)685(1)(2)A(5)	1.0	6.0	12.0	1
4	10	B/1505	T419B106(1)004(2)(3)(4)	CWR19C(3)106(1)(2)B(5)	1.0	8.0	8.0	1
4	15	B/1505	T419B156(1)004(2)(3)(4)	CWR19C(3)156(1)(2)B(5)	1.0	8.0	8.0	1
4	22	B/1505	T419B226(1)004(2)(3)(4)	CWR19C(3)226(1)(2)B(5)	1.0	8.0	8.0	1
4	22	D/1510	T419D226(1)004(2)(3)(4)	CWR19C(3)226(1)(2)D(5)	1.0	8.0	4.0	1
4	33	D/1510	T419D336(1)004(2)(3)(4)	CWR19C(3)336(1)(2)D(5)	2.0	8.0	4.0	1
4	33	E/2010	T419E336(1)004(2)(3)(4)	CWR19C(3)336(1)(2)E(5)	2.0	8.0	3.0	1
4	47	E/2010	T419E476(1)004(2)(3)(4)	CWR19C(3)476(1)(2)E(5)	2.0	8.0	3.0	1
4	68	E/2010	T419E686(1)004(2)(3)(4)	CWR19C(3)686(1)(2)E(5)	3.0	8.0	3.0	1
4	100	F/2214	T419F107(1)004(2)(3)(4)	CWR19C(3)107(1)(2)F(5)	4.0	10.0	2.0	1
4	150	G/2711	T419G157(1)004(2)(3)(4)	CWR19C(3)157(1)(2)G(5)	6.0	10.0	1.0	1
4	220	H/2915	T419H227(1)004(2)(3)(4)	CWR19C(3)227(1)(2)H(5)	8.0	10.0	1.0	1
4	330	H/2915	T419H337(1)004(2)(3)(4)	CWR19C(3)337(1)(2)H(5)	10.0	10.0	0.9	1
6	3.3	A/1005	T419A335(1)006(2)(3)(4)	CWR19D(3)335(1)(2)A(5)	1.0	6.0	12.0	1
6	4.7	A/1005	T419A475(1)006(2)(3)(4)	CWR19D(3)475(1)(2)A(5)	1.0	6.0	12.0	1
6	6.8	B/1505	T419B685(1)006(2)(3)(4)	CWR19D(3)685(1)(2)B(5)	1.0	6.0	8.0	1
6	10	B/1505	T419B106(1)006(2)(3)(4)	CWR19D(3)106(1)(2)B(5)	1.0	6.0	8.0	1
6	15	B/1505	T419B156(1)006(2)(3)(4)	CWR19D(3)156(1)(2)B(5)	1.0	8.0	8.0	1
6	15	D/1510	T419D156(1)006(2)(3)(4)	CWR19D(3)156(1)(2)D(5)	1.0	8.0	5.0	1
6	15	E/2010	T419E156(1)006(2)(3)(4)	CWR19D(3)156(1)(2)E(5)	1.0	8.0	3.0	1
6	22	D/1510	T419D226(1)006(2)(3)(4)	CWR19D(3)226(1)(2)D(5)	1.0	6.0	5.0	1
6	22	E/2010	T419E226(1)006(2)(3)(4)	CWR19D(3)226(1)(2)E(5)	2.0	8.0	3.5	1
6	33	E/2010	T419E336(1)006(2)(3)(4)	CWR19D(3)336(1)(2)E(5)	2.0	6.0	3.5	1
6	47	F/2214	T419F476(1)006(2)(3)(4)	CWR19D(3)476(1)(2)F(5)	2.8	8.0	3.5	1
6	68	F/2214	T419F686(1)006(2)(3)(4)	CWR19D(3)686(1)(2)F(5)	4.0	10.0	1.5	1
6	68	G/2711	T419G686(1)006(2)(3)(4)	CWR19D(3)686(1)(2)G(5)	4.0	10.0	1.0	1
6	100	G/2711	T419G107(1)006(2)(3)(4)	CWR19D(3)107(1)(2)G(5)	6.0	10.0	1.1	1
6	150	G/2711	T419G157(1)006(2)(3)(4)	CWR19D(3)157(1)(2)G(5)	10.0	10.0	1.1	1
6	220	H/2915	T419H227(1)006(2)(3)(4)	CWR19D(3)227(1)(2)H(5)	10.0	10.0	0.9	1
6	330	H/2915	T419H337(1)006(2)(3)(4)	CWR19D(3)337(1)(2)H(5)	20.0	10.0	0.9	1
10	2.2	A/1005	T419A225(1)010(2)(3)(4)	CWR19F(3)225(1)(2)A(5)	1.0	6.0	12.0	1
10	3.3	A/1005	T419A335(1)010(2)(3)(4)	CWR19F(3)335(1)(2)A(5)	1.0	6.0	12.0	1
10	4.7	B/1505	T419B475(1)010(2)(3)(4)	CWR19F(3)475(1)(2)B(5)	1.0	6.0	8.0	1
10	4.7	C/2005	T419C475(1)010(2)(3)(4)	CWR19F(3)475(1)(2)C(5)	1.0	6.0	5.5	1
10	6.8	B/1505	T419B685(1)010(2)(3)(4)	CWR19F(3)685(1)(2)B(5)	1.0	6.0	8.0	1
10	6.8	C/2005	T419C685(1)010(2)(3)(4)	CWR19F(3)685(1)(2)C(5)	1.0	6.0	5.5	1
10	6.8	D/1510	T419D685(1)010(2)(3)(4)	CWR19F(3)685(1)(2)D(5)	1.0	6.0	5.0	1
10	10	B/1505	T419B106(1)010(2)(3)(4)	CWR19F(3)106(1)(2)B(5)	1.0	8.0	8.0	1
10	10	C/2005	T419C106(1)010(2)(3)(4)	CWR19F(3)106(1)(2)C(5)	1.0	6.0	5.5	1
10	10	D/1510	T419D106(1)010(2)(3)(4)	CWR19F(3)106(1)(2)D(5)	1.0	6.0	4.0	1
10	10	E/2010	T419E106(1)010(2)(3)(4)	CWR19F(3)106(1)(2)E(5)	1.0	6.0	3.5	1
10	15	D/1510	T419D156(1)010(2)(3)(4)	CWR19F(3)156(1)(2)D(5)	2.0	6.0	5.0	1
10	15	E/2010	T419E156(1)010(2)(3)(4)	CWR19F(3)156(1)(2)E(5)	2.0	8.0	3.0	1
10	22	E/2010	T419E226(1)010(2)(3)(4)	CWR19F(3)226(1)(2)E(5)	3.0	8.0	2.0	1
10	33	F/2214	T419F336(1)010(2)(3)(4)	CWR19F(3)336(1)(2)F(5)	3.0	8.0	1.5	1
10	47	F/2214	T419F476(1)010(2)(3)(4)	CWR19F(3)476(1)(2)F(5)	4.0	10.0	1.5	1
10	47	G/2711	T419G476(1)010(2)(3)(4)	CWR19F(3)476(1)(2)G(5)	4.0	10.0	1.0	1
VDC	µF	KEMET/EIA	(See below for part options)	(See below for part options)	µA @ +20°C Max/5 Min	% @ 20°C 120 Hz Max	Ω @ +20°C 100kHz Max	Reflow Temperature ≤ 260°C
Rated Voltage	Rated Cap	Case Code/ Case Size	KEMET Part Number	MIL-PRF-55365/11 Part Number	DC Leakage	DF	ESR	Moisture Sensitivity

(1) To complete KEMET/CWR part number, insert M for ±20%, K for ±10%, or J for ±5%. Designates Capacitance tolerance.

(2) To complete KEMET/CWR part number, insert B (0.1%/1,000 Hours), C (0.01%/1,000 Hours), D (0.001%/1,000 Hours) or A = N/A. Designates Reliability Level.

(3) To complete KEMET/CWR part number, insert B = Gold Plated, C = Hot solder dipped, H = Solder plated or K = Solder Fused. Designates Termination Finish.

(4) To complete KEMET part number, insert 4250 = +25°C after Weibull, 4251 = -55°C +85°C after Weibull, or 4252 = -55°C +85°C before Weibull. Designates Surge current option.

(5) To complete CWR part number, insert A = +25°C after Weibull, B = -55°C +85°C after Weibull, C = -55°C +85°C before Weibull or Z = None. Designates Surge current option.

Refer to Ordering Information for additional detail.

Table 1 – Ratings & Part Number Reference cont'd

Rated Voltage	Rated Cap	Case Code/ Case Size	KEMET Part Number	MIL-PRF-55365/11 Part Number	DC Leakage	DF	ESR	Moisture Sensitivity
VDC	µF	KEMET/EIA	(See below for part options)	(See below for part options)	µA @ +20°C Max/5 Min	% @ 20°C 120 Hz Max	Ω @ +20°C 100kHz Max	Reflow Temperature ≤ 260°C
10	68	G/2711	T419G686(1)010(2)(3)(4)	CWR19F(3)686(1)(2)G(5)	6.0	10.0	1.1	1
10	100	G/2711	T419G107(1)010(2)(3)(4)	CWR19F(3)107(1)(2)G(5)	10.0	10.0	1.1	1
10	100	H/2915	T419H107(1)010(2)(3)(4)	CWR19F(3)107(1)(2)H(5)	10.0	10.0	0.9	1
10	150	H/2915	T419H157(1)010(2)(3)(4)	CWR19F(3)157(1)(2)H(5)	15.0	10.0	0.9	1
10	150	X/2824	T419X157(1)010(2)(3)(4)	CWR19F(3)157(1)(2)X(5)	15.0	10.0	0.9	1
10	220	H/2915	T419H227(1)010(2)(3)(4)	CWR19F(3)227(1)(2)H(5)	20.0	10.0	0.9	1
15	1	A/1005	T419A105(1)015(2)(3)(4)	CWR19H(3)105(1)(2)A(5)	1.0	6.0	15.0	1
15	1.5	A/1005	T419A155(1)015(2)(3)(4)	CWR19H(3)155(1)(2)A(5)	1.0	6.0	15.0	1
15	2.2	A/1005	T419A225(1)015(2)(3)(4)	CWR19H(3)225(1)(2)A(5)	1.0	6.0	15.0	1
15	3.3	B/1505	T419B335(1)015(2)(3)(4)	CWR19H(3)335(1)(2)B(5)	1.0	6.0	9.0	1
15	4.7	B/1505	T419B475(1)015(2)(3)(4)	CWR19H(3)475(1)(2)B(5)	1.0	6.0	5.0	1
15	4.7	C/2005	T419C475(1)015(2)(3)(4)	CWR19H(3)475(1)(2)C(5)	1.0	6.0	5.5	1
15	4.7	D/1510	T419D475(1)015(2)(3)(4)	CWR19H(3)475(1)(2)D(5)	1.0	6.0	6.0	1
15	6.8	D/1510	T419D685(1)015(2)(3)(4)	CWR19H(3)685(1)(2)D(5)	1.0	6.0	6.0	1
15	6.8	E/2010	T419E685(1)015(2)(3)(4)	CWR19H(3)685(1)(2)E(5)	1.0	8.0	3.0	1
15	10	D/1510	T419D106(1)015(2)(3)(4)	CWR19H(3)106(1)(2)D(5)	2.0	6.0	6.0	1
15	10	E/2010	T419E106(1)015(2)(3)(4)	CWR19H(3)106(1)(2)E(5)	2.0	6.0	4.0	1
15	15	E/2010	T419E156(1)015(2)(3)(4)	CWR19H(3)156(1)(2)E(5)	2.0	6.0	4.0	1
15	15	F/2214	T419F156(1)015(2)(3)(4)	CWR19H(3)156(1)(2)F(5)	2.0	8.0	3.0	1
15	22	F/2214	T419F226(1)015(2)(3)(4)	CWR19H(3)226(1)(2)F(5)	3.0	8.0	3.0	1
15	33	F/2214	T419F336(1)015(2)(3)(4)	CWR19H(3)336(1)(2)F(5)	5.0	6.0	3.0	1
15	33	G/2711	T419G336(1)015(2)(3)(4)	CWR19H(3)336(1)(2)G(5)	6.0	8.0	1.1	1
15	47	G/2711	T419G476(1)015(2)(3)(4)	CWR19H(3)476(1)(2)G(5)	10.0	8.0	1.1	1
15	47	H/2915	T419H476(1)015(2)(3)(4)	CWR19H(3)476(1)(2)H(5)	10.0	8.0	0.9	1
15	68	G/2711	T419G686(1)015(2)(3)(4)	CWR19H(3)686(1)(2)G(5)	10.0	8.0	1.1	1
15	68	H/2915	T419H686(1)015(2)(3)(4)	CWR19H(3)686(1)(2)H(5)	10.0	8.0	0.9	1
15	100	H/2915	T419H107(1)015(2)(3)(4)	CWR19H(3)107(1)(2)H(5)	15.0	10.0	0.9	1
20	0.68	A/1005	T419A684(1)020(2)(3)(4)	CWR19J(3)684(1)(2)A(5)	1.0	6.0	15.0	1
20	1	A/1005	T419A105(1)020(2)(3)(4)	CWR19J(3)105(1)(2)A(5)	1.0	6.0	15.0	1
20	1.5	B/1505	T419B155(1)020(2)(3)(4)	CWR19J(3)155(1)(2)B(5)	1.0	6.0	9.0	1
20	2.2	B/1505	T419B225(1)020(2)(3)(4)	CWR19J(3)225(1)(2)B(5)	1.0	6.0	9.0	1
20	3.3	D/1510	T419D335(1)020(2)(3)(4)	CWR19J(3)335(1)(2)D(5)	1.0	6.0	6.0	1
20	4.7	E/2010	T419E475(1)020(2)(3)(4)	CWR19J(3)475(1)(2)E(5)	1.0	6.0	6.0	1
20	6.8	E/2010	T419E685(1)020(2)(3)(4)	CWR19J(3)685(1)(2)E(5)	2.0	6.0	5.0	1
20	10	E/2010	T419E106(1)020(2)(3)(4)	CWR19J(3)106(1)(2)E(5)	2.0	6.0	5.0	1
20	10	F/2214	T419F106(1)020(2)(3)(4)	CWR19J(3)106(1)(2)F(5)	2.0	6.0	3.0	1
20	15	F/2214	T419F156(1)020(2)(3)(4)	CWR19J(3)156(1)(2)F(5)	3.0	6.0	3.0	1
20	22	G/2711	T419G226(1)020(2)(3)(4)	CWR19J(3)226(1)(2)G(5)	4.0	6.0	2.5	1
20	33	H/2915	T419H336(1)020(2)(3)(4)	CWR19J(3)336(1)(2)H(5)	6.0	8.0	0.9	1
20	47	H/2915	T419H476(1)020(2)(3)(4)	CWR19J(3)476(1)(2)H(5)	10.0	8.0	0.9	1
20	47	X/2824	T419X476(1)020(2)(3)(4)	CWR19J(3)476(1)(2)X(5)	10.0	8.0	0.9	1
25	0.47	A/1005	T419A474(1)025(2)(3)(4)	CWR19K(3)474(1)(2)A(5)	1.0	6.0	15.0	1
25	1	B/1505	T419B105(1)025(2)(3)(4)	CWR19K(3)105(1)(2)B(5)	1.0	6.0	10.0	1
25	2.2	D/1510	T419D225(1)025(2)(3)(4)	CWR19K(3)225(1)(2)D(5)	1.0	6.0	6.0	1
25	3.3	E/2010	T419E335(1)025(2)(3)(4)	CWR19K(3)335(1)(2)E(5)	1.0	6.0	4.0	1
25	6.8	F/2214	T419F685(1)025(2)(3)(4)	CWR19K(3)685(1)(2)F(5)	2.0	6.0	3.0	1
25	15	G/2711	T419G156(1)025(2)(3)(4)	CWR19K(3)156(1)(2)G(5)	4.0	6.0	1.4	1
25	22	G/2711	T419G226(1)025(2)(3)(4)	CWR19K(3)226(1)(2)G(5)	6.0	6.0	1.4	1
25	22	H/2915	T419H226(1)025(2)(3)(4)	CWR19K(3)226(1)(2)H(5)	6.0	6.0	0.9	1
VDC	µF	KEMET/EIA	(See below for part options)	(See below for part options)	µA @ +20°C Max/5 Min	% @ 20°C 120 Hz Max	Ω @ +20°C 100kHz Max	Reflow Temperature ≤ 260°C
Rated Voltage	Rated Cap	Case Code/ Case Size	KEMET Part Number	MIL-PRF-55365/11 Part Number	DC Leakage	DF	ESR	Moisture Sensitivity

(1) To complete KEMET/CWR part number, insert M for ±20%, K for ±10%, or J for ±5%. Designates Capacitance tolerance.

(2) To complete KEMET/CWR part number, insert B (0.1%/1,000 Hours), C (0.01%/1,000 Hours), D (0.001%/1,000 Hours) or A = N/A. Designates Reliability Level.

(3) To complete KEMET/CWR part number, insert B = Gold Plated, C = Hot solder dipped, H = Solder plated or K = Solder Fused. Designates Termination Finish.

(4) To complete KEMET part number, insert 4250 = +25°C after Weibull, 4251 = -55°C +85°C after Weibull, or 4252 = -55°C +85°C before Weibull. Designates Surge current option.

(5) To complete CWR part number, insert A = +25°C after Weibull, B = -55°C +85°C after Weibull, C = -55°C +85°C before Weibull or Z = None. Designates Surge current option.

Refer to Ordering Information for additional detail.

Table 1 – Ratings & Part Number Reference cont'd

Rated Voltage	Rated Cap	Case Code/ Case Size	KEMET Part Number	MIL-PRF-55365/11 Part Number	DC Leakage	DF	ESR	Moisture Sensitivity
VDC	μF	KEMET/EIA	(See below for part options)	(See below for part options)	μA @ +20°C Max/5 Min	% @ 20°C 120 Hz Max	Ω @ +20°C 100 kHz Max	Reflow Temperature ≤ 260°C
25	22	X/2824	T419X226(1)025(2)(3)(4)	CWR19K(3)226(1)(2)X(5)	6.0	6.0	0.9	1
25	33	H/2915	T419H336(1)025(2)(3)(4)	CWR19K(3)336(1)(2)H(5)	10.0	8.0	0.9	1
25	33	X/2824	T419X336(1)025(2)(3)(4)	CWR19K(3)336(1)(2)X(5)	10.0	8.0	0.9	1
35	0.33	A/1005	T419A334(1)035(2)(3)(4)	CWR19M(3)334(1)(2)A(5)	1.0	6.0	22.0	1
35	6.8	G/2711	T419G685(1)035(2)(3)(4)	CWR19M(3)685(1)(2)G(5)	3.0	6.0	1.5	1
35	10	H/2915	T419H106(1)035(2)(3)(4)	CWR19M(3)106(1)(2)H(5)	4.0	8.0	0.9	1
35	15	X/2824	T419X156(1)035(2)(3)(4)	CWR19M(3)156(1)(2)X(5)	6.0	6.0	0.9	1
VDC	μF	KEMET/EIA	(See below for part options)	(See below for part options)	μA @ +20°C Max/5 Min	% @ 20°C 120 Hz Max	Ω @ +20°C 100 kHz Max	Reflow Temperature ≤ 260°C
Rated Voltage	Rated Cap	Case Code/ Case Size	KEMET Part Number	MIL-PRF-55365/11 Part Number	DC Leakage	DF	ESR	Moisture Sensitivity

(1) To complete KEMET/CWR part number, insert M for ±20%, K for ±10%, or J for ±5%. Designates Capacitance tolerance.

(2) To complete KEMET/CWR part number, insert failure rate letter per the Ordering Information found on page 2. Designates Reliability Level.

(3) To complete KEMET/CWR part number, insert B = Gold Plated, C = Hot solder dipped, H = Solder plated or K = Solder Fused. Designates Termination Finish.

(4) To complete KEMET part number, insert 4250 = +25°C after Weibull, 4251 = -55°C +85°C after Weibull, or 4252 = -55°C +85°C before Weibull. Designates Surge current option.

(5) To complete CWR part number, insert A = +25°C after Weibull, B = -55°C +85°C after Weibull, C = -55°C +85°C before Weibull or Z = None. Designates Surge current option.

Refer to Ordering Information for additional detail.

Recommended Voltage Derating Guidelines

	-55°C to 85°C	85°C to 125°C
% Change in Working DC Voltage with Temperature	V_R	67% of V_R
Recommended Maximum Application Voltage	50% of V_R	33% of V_R

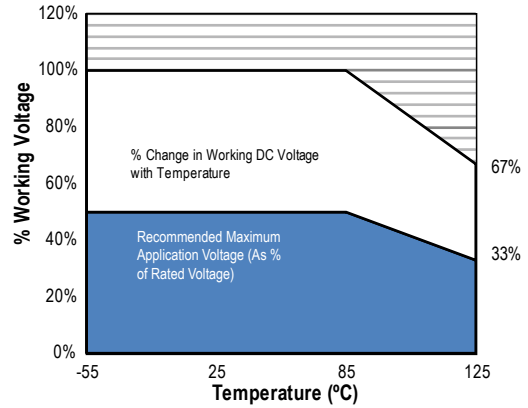

Ripple Current/Ripple Voltage

Permissible AC ripple voltage and current are related to equivalent series resistance (ESR) and the power dissipation capabilities of the device. Permissible AC ripple voltage which may be applied is limited by two criteria:

1. The positive peak AC voltage plus the DC bias voltage, if any, must not exceed the DC voltage rating of the capacitor.
2. The negative peak AC voltage in combination with bias voltage, if any, must not exceed the allowable limits specified for reverse voltage. See the Reverse Voltage section for allowable limits.

The maximum power dissipation by case size can be determined using the table at right. The maximum power dissipation rating stated in the table must be reduced with increasing environmental operating temperatures. Refer to the table below for temperature compensation requirements.

KEMET Case Code	EIA Case Code	Maximum Power Dissipation (P max) mWatts @ 25°C w/+20°C Rise
A	1005	50
B	1505	70
C	2005	75
D	1510	80
E	2010	90
F	2214	100
G	2711	125
H	2915	150

The maximum power dissipation rating must be reduced with increasing environmental operating temperatures. Refer to the Temperature Compensation Multiplier table for details.

Temperature Compensation Multipliers for Maximum Power Dissipation		
T ≤ 25°C	T ≤ 85°C	T ≤ 125°C
1.00	0.90	0.40

T= Environmental Temperature

Using the P max of the device, the maximum allowable rms ripple current or voltage may be determined.

$$I(max) = \sqrt{P_{max}/R}$$

$$E(max) = Z \sqrt{P_{max}/R}$$

I = rms ripple current (amperes)

E = rms ripple voltage (volts)

P max = maximum power dissipation (watts)

R = ESR at specified frequency (ohms)

Z = Impedance at specified frequency (ohms)

Reverse Voltage

Solid tantalum capacitors are polar devices and may be permanently damaged or destroyed if connected with the wrong polarity. The positive terminal is identified on the capacitor body by a stripe plus in some cases a beveled edge. A small degree of transient reverse voltage is permissible for short periods per the table. The capacitors should not be operated continuously in reverse mode, even within these limits.

Temperature	Permissible Transient Reverse Voltage
25°C	15% of Rated Voltage
85°C	5% of Rated Voltage
125°C	1% of Rated Voltage

Table 2 – Land Dimensions/Courtyard

KEMET	Metric Size Code	Density Level A: Maximum (Most) Land Protrusion (mm)					Density Level B: Median (Nominal) Land Protrusion (mm)					Density Level C: Minimum (Least) Land Protrusion (mm)				
		L	W	S	V1	V2	L	W	S	V1	V2	L	W	S	V1	V2
A ¹	1005	2.19	1.44	0.15	5.54	2.66	1.89	1.32	0.15	4.44	2.16	1.52	1.22	0.29	3.58	1.90
B	1505	2.30	1.44	1.20	6.80	2.66	1.90	1.32	1.40	5.70	2.16	1.52	1.22	1.56	4.84	1.90
C	2005	2.30	1.44	2.47	8.08	2.66	1.90	1.32	2.67	6.98	2.16	1.52	1.22	2.83	6.12	1.90
D	1510	2.30	2.58	1.20	6.80	3.92	1.90	2.46	1.40	5.70	3.42	1.52	2.36	1.56	4.84	3.16
E	2010	2.30	2.58	2.47	8.08	3.92	1.90	2.46	2.67	6.98	3.42	1.52	2.36	2.83	6.12	3.16
F	2214	2.30	3.47	2.98	8.58	4.82	1.90	3.35	3.18	7.48	4.32	1.52	3.25	3.34	6.62	4.06
G	2711	2.81	2.84	3.10	9.72	4.18	2.41	2.72	3.30	8.62	3.68	2.03	2.62	3.46	7.76	3.42
H	2915	2.81	3.84	3.61	10.24	5.20	2.41	3.72	3.81	9.14	4.70	2.03	3.62	3.97	8.28	4.44
X	2824	2.73	3.22	3.46	9.92	6.80	2.33	3.10	3.66	8.82	6.30	1.95	3.00	3.82	7.96	6.04

Density Level A: For low-density product applications. Recommended for wave solder applications and provides a wider process window for reflow solder processes.

Density Level B: For products with a moderate level of component density. Provides a robust solder attachment condition for reflow solder processes.

Density Level C: For high component density product applications. Before adapting the minimum land pattern variations the user should perform qualification testing based on the conditions outlined in IPC standard 7351 (IPC-7351).

¹ Land pattern geometry is too small for silkscreen outline.

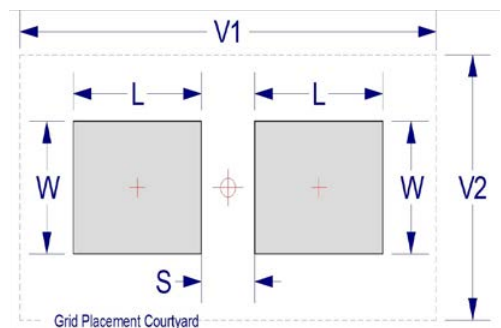

Soldering Process

KEMET's families of surface mount capacitors are compatible with wave (single or dual), convection, IR, or vapor phase reflow techniques. Preheating of these components is recommended to avoid extreme thermal stress. KEMET's recommended profile conditions for convection and IR reflow reflect the profile conditions of the IPC/J-STD-020D standard for moisture sensitivity testing. The devices can safely withstand a maximum of three reflow passes at these conditions.

Note that although the X/7343-43 case size can withstand wave soldering, the tall profile (4.3 mm maximum) dictates care in wave process development.

Hand soldering should be performed with care due to the difficulty in process control. If performed, care should be taken to avoid contact of the soldering iron to the molded case. The iron should be used to heat the solder pad, applying solder between the pad and the termination, until reflow occurs. Once reflow occurs, the iron should be removed immediately. "Wiping" the edges of a chip and heating the top surface is not recommended.

During typical reflow operations, a slight darkening of the gold-colored epoxy may be observed. This slight darkening is normal and not harmful to the product. Marking permanency is not affected by this change.

Profile Feature	SnPb Assembly	Pb-Free Assembly
Preheat/Soak		
Temperature Minimum (T_{Smin})	100°C	150°C
Temperature Maximum (T_{Smax})	150°C	200°C
Time (t_s) from T_{Smin} to T_{Smax}	60 – 120 seconds	60 – 120 seconds
Ramp-up Rate (T_L to T_p)	3°C/seconds maximum	3°C/seconds maximum
Liquidous Temperature (T_L)	183°C	217°C
Time Above Liquidous (t_L)	60 – 150 seconds	60 – 150 seconds
Peak Temperature (T_p)	220°C* 235°C**	250°C* 260°C**
Time within 5°C of Maximum Peak Temperature (t_p)	20 seconds maximum	30 seconds maximum
Ramp-down Rate (T_p to T_L)	6°C/seconds maximum	6°C/seconds maximum
Time 25°C to Peak Temperature	6 minutes maximum	8 minutes maximum

Note: All temperatures refer to the center of the package, measured on the package body surface that is facing up during assembly reflow.

*Case Size D, E, P, Y, and X

**Case Size A, B, C, H, I, K, M, R, S, T, U, V, W, and Z

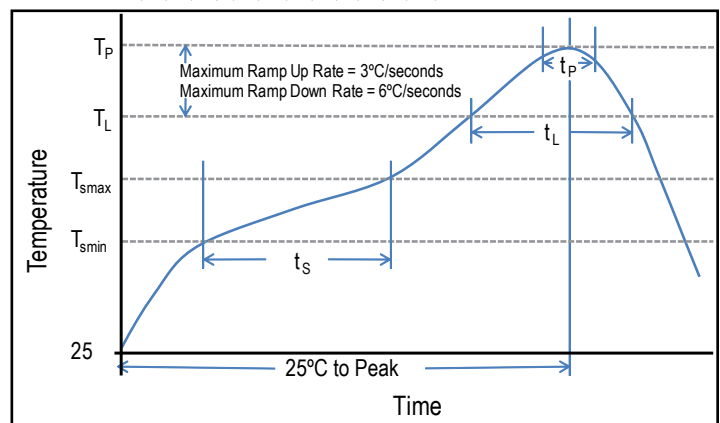

Construction

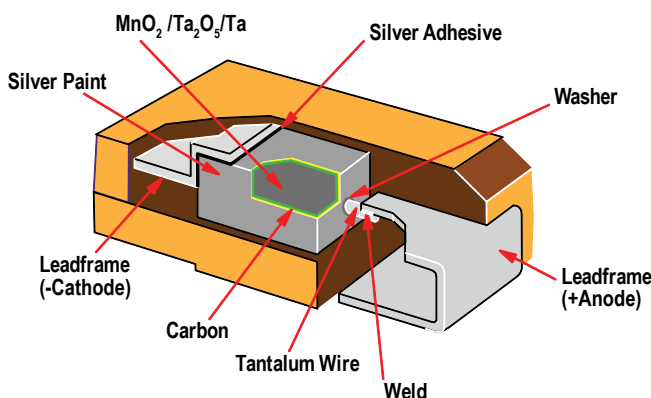

Capacitor Marking

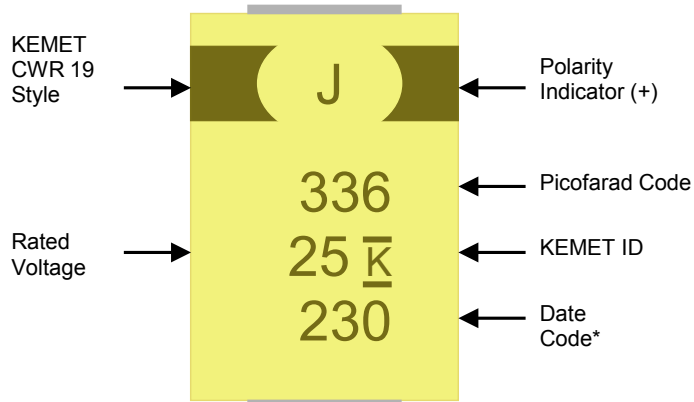

* 230 = 30th week of 2012

Date Code *	
1 st digit = Last number of Year	9 = 2009 0 = 2010 1 = 2011 2 = 2012 3 = 2013 4 = 2014
2 nd and 3 rd digit = Week of the Year	01 = 1 st week of the Year to 52 = 52 nd week of the Year

Storage

Tantalum chip capacitors should be stored in normal working environments. While the chips themselves are quite robust in other environments, solderability will be degraded by exposure to high temperatures, high humidity, corrosive atmospheres, and long term storage. In addition, packaging materials will be degraded by high temperature– reels may soften or warp and tape peel force may increase. KEMET recommends that maximum storage temperature not exceed 40°C and maximum storage humidity not exceed 60% relative humidity. Temperature fluctuations should be minimized to avoid condensation on the parts and atmospheres should be free of chlorine and sulphur bearing compounds. For optimized solderability chip stock should be used promptly, preferably within three years of receipt.

Overview

The KEMET T429 Series is approved to MIL-PRF-55365/11 (CWR290) with Weibull failure rates of B level (0.1% failures per 1,000 hours), C level (0.01% failures per 1,000 hours), D level (0.001% failures per 1,000 hours), or T level (0.01% failures per 1,000 hours), Option C surge current, DPA, Radiographic

inspection, 100% visual inspection, DCL and ESR measurements within +3 standard deviations, and Group C inspection). This CWR29 product is a precision-molded device with compliant terminations and indelible laser marking. Tape and reeling per EIA 481-1 is standard.

Benefits

- Established reliability options
- Taped and reeled per EIA 481-1
- Symmetrical, compliant terminations
- Laser-marked case
- 100% surge current test available on all case sizes
- Qualified to MIL-PRF-55365/11, Style CWR29
- Termination options B, C, H, K
- Weibull failure options B, C, D, and T
- Exponential failure rates M, P, R, S
- Voltage rating of 4 – 50 VDC
- Operating temperature range of -55°C to +125°C

Applications

Typical applications include decoupling and filtering in military and aerospace applications requiring CWR29 devices.



Environmental Compliance

RoHS Compliant (6/6) according to Directive 2002/95/EC when ordered with 100% Sn Solder.



RoHS Compliant

SPICE

For a detailed analysis of specific part numbers, please visit www.kemet.com for a free download of KEMET's SPICE software. The KEMET SPICE program is freeware intended to aid design engineers in analyzing the performance of these capacitors over frequency, temperature, ripple, and DC bias conditions.

KEMET Ordering Information

T	429	A	225	K	004	A	H	4251	7280
Capacitor Class	Series	Case Size	Capacitance Code (pF)	Capacitance Tolerance	Voltage	Failure Rate/Design	Lead Material	Surge	Packaging (C-Spec)
T = Tantalum	CWR29 Established Reliability	A, B, C, D, E, F, G, H, X	First two digits represent significant figures. Third digit specifies number of zeros.	J = ±5% K = ±10% M = ±20%	004 = 4 V 006 = 6.3 V 010 = 10 V 015 = 15 V 020 = 20 V 025 = 25 V 035 = 35 V 050 = 50 V	Weibull A = non-ER B = (0.1%/1,000 hours) C = (0.01%/1,000 hours) D = (0.001%/1,000 hours) T = (0.01%/1,000 hours) Exponential M = (1.0%/1,000 hours) P = (0.1%/1,000 hours) R = (0.01%/1,000 hours) S = (0.001%/1,000 hours)	C = Hot Solder Dipped H = Standard Solder Coated (SnPb 5% Pb minimum) B = Gold Plated K = Solder Fused	Blank = No surge 4250 = 25°C after Weibull 4251 = -55°C and 85°C after Weibull 4252 = -55°C and 85°C before Weibull TLVL = Weibull Grade Level "T"	Blank = 7" Reel 7280 = 13" Reel 7610 = Bag 7005 = Moisture bags

Defense MIL-PRF-55365/11 Ordering Information

CWR29	K	H	225	K	C	D	A
Capacitor Style	Voltage	Termination Finish	Capacitance Code (pF)	Capacitance Tolerance	Reliability Level	Case Code	Surge Current Option
Per MIL-PRF-55365/11	C = 4 V D = 6 V F = 10 V H = 15 V J = 20 V K = 25 V M = 35 V N = 50 V	B = Gold Plated C = Hot solder dipped H = Solder Plated K = Solder fused	First two digits represent significant figures. Third digit specifies number of zeros.	J = ±5% K = ±10% M = ±20%	Weibull A = non-ER B = (0.1%/1,000 hours) C = (0.01%/1,000 hours) D = (0.001%/1,000 hours) T = T Level* (0.01%/1,000 hours) Exponential M = (1.0%/1,000 hours) P = (0.1%/1,000 hours) R = (0.01%/1,000 hours) S = (0.001%/1,000 hours)	A, B, C, D, E, F, G, H, X	A = +25°C after Weibull B = -55°C +85°C after Weibull C = -55°C +85°C before Weibull Z = None

* When T Level is ordered, no Surge Current Option is needed

Performance Characteristics

Item	Performance Characteristics
Operating Temperature	-55°C to 125°C
Rated Capacitance Range	0.1 – 330 µF @ 120 Hz/25°C
Capacitance Tolerance	J Tolerance (5%), K Tolerance (10%), M Tolerance (20%)
Rated Voltage Range	4 – 50 V
DF (120 Hz)	Refer to Part Number Electrical Specification Table
ESR (100 kHz)	Refer to Part Number Electrical Specification Table
Leakage Current	≤ 0.01 CV (µA) at rated voltage after 5 minutes

Qualification

Test	Condition	Characteristics				
Endurance	85°C @ rated voltage, 2,000 hours 125°C @ 2/3 rated voltage, 2,000 hours	Δ C/C	Within ±10% of initial value			
		DF	Within initial limits			
		DCL	Within 1.25 x initial limit			
		ESR	Within initial limits			
Storage Life	125°C @ 0 volts, 2,000 hours	Δ C/C	Within ±10% of initial value			
		DF	Within initial limits			
		DCL	Within 1.25 x initial limit			
		ESR	Within initial limits			
Thermal Shock	MIL-STD-202, Method 107, Condition B, mounted, -55°C to 125°C, 1,000 cycles	Δ C/C	Within ±5% of initial value			
		DF	Within initial limits			
		DCL	Within 1.25 x initial limit			
		ESR	Within initial limits			
Temperature Stability	Extreme temperature exposure at a succession of continuous steps at +25°C, -55°C, +25°C, +85°C, +125°C, +25°C	+25°C	-55°C	+85°C	+125°C	
		Δ C/C	IL*	±10%	±10%	±20%
		DF	IL	IL	1.5 x IL	1.5 x IL
Surge Voltage	25°C and 85°C, 1.32 x rated voltage 1,000 cycles (125°C, 1.2 x rated voltage)	DCL	IL			
		ESR	n/a			
		DCL	10 x IL			
Mechanical Shock/Vibration	MIL-STD-202, Method 213, Condition I, 100 G Peak MIL-STD-202, Method 204, Condition D, 10 Hz to 2,000 Hz, 20 G peak	Δ C/C	Within ±10% of initial value			
		DF	Within initial limits			
		DCL	Within initial limits			
Additional qualification tests per MIL-PRF-55365/11	Please contact KEMET for more information.					

*IL = Initial limit

Certification

MIL-PRF-55365/11

Electrical Characteristics

ESR vs. Frequency

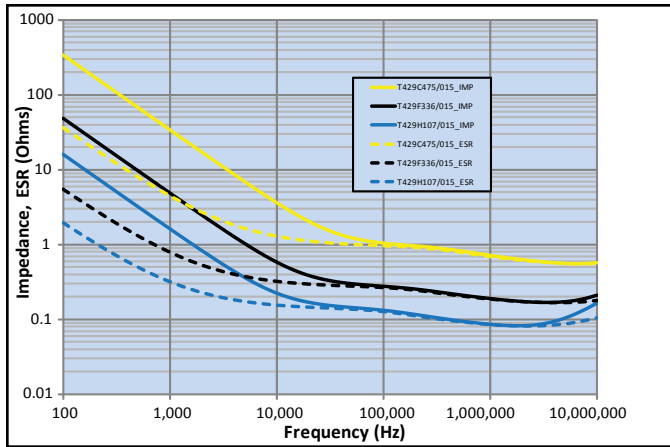

Capacitance vs. Frequency

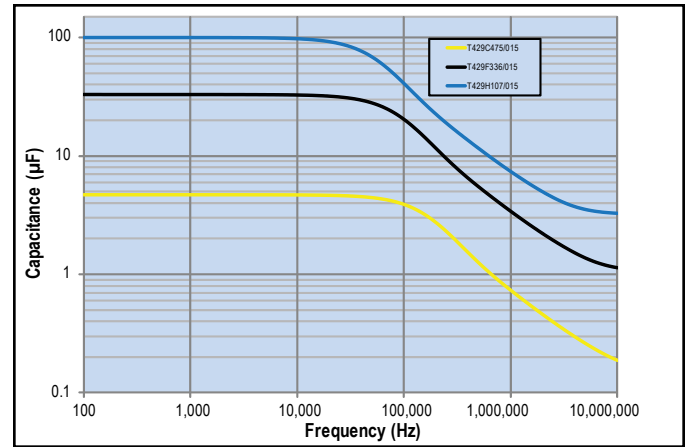

Dimensions – Millimeters (Inches)

Metric will govern

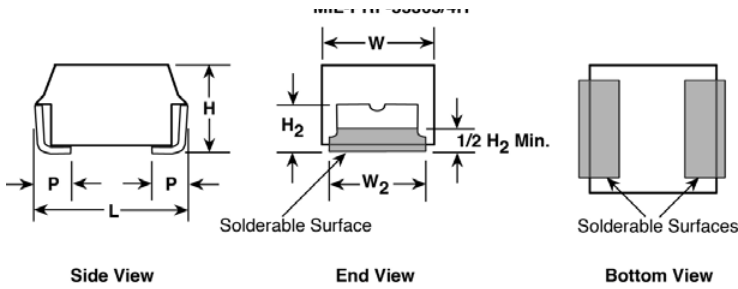

Case Size	Component					
KEMET	L* ±0.38 (0.015)	W* ±0.38 (0.015)	H* ±0.38 (0.015)	P +0.25 (0.010), -0.13 (0.005)	W ₂	H ₂ Minimum
A	2.54 (0.100)	1.27 (0.050)	1.27 (0.050)	0.76 (0.030)	1.27 ±0.13 (0.050 ±0.005)	0.76 (0.030)
B	3.81 (0.150)	1.27 (0.050)	1.27 (0.050)	0.76 (0.030)	1.27 ±0.13 (0.050 ±0.005)	0.76 (0.030)
C	5.08 (0.200)	1.27 (0.050)	1.27 (0.050)	0.76 (0.030)	1.27 ±0.13 (0.050 ±0.005)	0.76 (0.030)
D	3.81 (0.150)	2.54 (0.100)	1.27 (0.050)	0.76 (0.030)	2.41 +0.13, -0.25 (0.095 +0.005, -0.010)	0.76 (0.030)
E	5.08 (0.200)	2.54 (0.100)	1.27 (0.050)	0.76 (0.030)	2.41 +0.13, -0.25 (0.095 +0.005, -0.010)	0.76 (0.030)
F	5.59 (0.220)	3.43 (0.135)	1.78 (0.070)	0.76 (0.030)	3.30 ±0.13 (0.130 ±0.005)	1.02 (0.040)
G	6.73 (0.265)	2.79 (0.110)	2.79 (0.110)	1.27 (0.050)	2.67 ±0.13 (0.105 ±0.005)	1.52 (0.060)
H	7.24 (0.285)	3.81 (0.150)	2.79 (0.110)	1.27 (0.050)	3.68 +0.013, -0.51 (0.145 +0.005, -0.020)	1.52 (0.060)
X	6.93 (0.273)	5.41 (0.213)	2.74 (0.108)	1.19 (0.047)	3.05 ±0.13 (0.120 ±0.005)	1.22 (0.048)

Note: When solder coated terminations are required, add an additional 0.38 mm (0.015 inch) to the above tolerances for "L", "W", "H", "P", "W₂" and "H₂"

Table 1 – Ratings & Part Number Reference

Rated Voltage	Rated Cap	Case Code/ Case Size	KEMET Part Number	MIL-PRF-55365/11 Part Number	DC Leakage	DF	ESR	Moisture Sensitivity
VDC	µF	KEMET/EIA	(See below for part options)	(See below for part options)	µA @ +20°C Max/5 Min	% @ +20°C 120 Hz Max	Ω @ +20°C 100 kHz Max	Reflow Temperature ≤ 260°C
4	2.2	A/1005	T429A225(1)004(2)(3)(4)	CWR29C(3)225(1)(2)A(5)	1.0	6.0	4.0	1
4	3.3	A/1005	T429A335(1)004(2)(3)(4)	CWR29C(3)335(1)(2)A(5)	1.0	6.0	6.0	1
4	4.7	A/1005	T429A475(1)004(2)(3)(4)	CWR29C(3)475(1)(2)A(5)	1.0	6.0	6.0	1
4	4.7	B/1505	T429B475(1)004(2)(3)(4)	CWR29C(3)475(1)(2)B(5)	1.0	6.0	3.2	1
4	6.8	A/1005	T429A685(1)004(2)(3)(4)	CWR29C(3)685(1)(2)A(5)	1.0	6.0	6.0	1
4	6.8	C/2005	T429C685(1)004(2)(3)(4)	CWR29C(3)685(1)(2)C(5)	1.0	6.0	2.2	1
4	10	B/1505	T429B106(1)004(2)(3)(4)	CWR29C(3)106(1)(2)B(5)	1.0	8.0	3.2	1
4	10	D/1510	T429D106(1)004(2)(3)(4)	CWR29C(3)106(1)(2)D(5)	1.0	8.0	1.3	1
4	15	B/1505	T429B156(1)004(2)(3)(4)	CWR29C(3)156(1)(2)B(5)	1.0	8.0	3.2	1
4	15	E/2010	T429E156(1)004(2)(3)(4)	CWR29C(3)156(1)(2)E(5)	1.0	8.0	1.0	1
4	22	B/1505	T429B226(1)004(2)(3)(4)	CWR29C(3)226(1)(2)B(5)	1.0	8.0	3.2	1
4	22	D/1510	T429D226(1)004(2)(3)(4)	CWR29C(3)226(1)(2)D(5)	1.0	8.0	1.3	1
4	33	D/1510	T429D336(1)004(2)(3)(4)	CWR29C(3)336(1)(2)D(5)	2.0	8.0	1.3	1
4	33	E/2010	T429E336(1)004(2)(3)(4)	CWR29C(3)336(1)(2)E(5)	2.0	8.0	0.9	1
4	33	F/2214	T429F336(1)004(2)(3)(4)	CWR29C(3)336(1)(2)F(5)	2.0	8.0	0.6	1
4	47	E/2010	T429E476(1)004(2)(3)(4)	CWR29C(3)476(1)(2)E(5)	2.0	8.0	0.9	1
4	68	E/2010	T429E686(1)004(2)(3)(4)	CWR29C(3)686(1)(2)E(5)	3.0	8.0	0.9	1
4	68	G/2711	T429G686(1)004(2)(3)(4)	CWR29C(3)686(1)(2)G(5)	3.0	10.0	0.275	1
4	100	F/2214	T429F107(1)004(2)(3)(4)	CWR29C(3)107(1)(2)F(5)	4.0	10.0	0.55	1
4	100	H/2915	T429H107(1)004(2)(3)(4)	CWR29C(3)107(1)(2)H(5)	4.0	10.0	0.18	1
4	150	G/2711	T429G157(1)004(2)(3)(4)	CWR29C(3)157(1)(2)G(5)	6.0	10.0	0.25	1
4	220	H/2915	T429H227(1)004(2)(3)(4)	CWR29C(3)227(1)(2)H(5)	8.0	10.0	0.20	1
4	330	H/2915	T429H337(1)004(2)(3)(4)	CWR29C(3)337(1)(2)H(5)	10.0	10.0	0.18	1
6	1.5	A/1005	T429A155(1)006(2)(3)(4)	CWR29D(3)155(1)(2)A(5)	1.0	6.0	4.0	1
6	3.3	A/1005	T429A335(1)006(2)(3)(4)	CWR29D(3)335(1)(2)A(5)	1.0	6.0	6.0	1
6	3.3	B/1505	T429B335(1)006(2)(3)(4)	CWR29D(3)335(1)(2)B(5)	1.0	6.0	3.2	1
6	4.7	A/1005	T429A475(1)006(2)(3)(4)	CWR29D(3)475(1)(2)A(5)	1.0	6.0	6.0	1
6	4.7	C/2005	T429C475(1)006(2)(3)(4)	CWR29D(3)475(1)(2)C(5)	1.0	6.0	2.2	1
6	6.8	B/1505	T429B685(1)006(2)(3)(4)	CWR29D(3)685(1)(2)B(5)	1.0	6.0	3.2	1
6	6.8	D/1510	T429D685(1)006(2)(3)(4)	CWR29D(3)685(1)(2)D(5)	1.0	6.0	1.5	1
6	10	B/1505	T429B106(1)006(2)(3)(4)	CWR29D(3)106(1)(2)B(5)	1.0	6.0	3.2	1
6	10	E/2010	T429E106(1)006(2)(3)(4)	CWR29D(3)106(1)(2)E(5)	1.0	8.0	1.0	1
6	15	B/1505	T429B156(1)006(2)(3)(4)	CWR29D(3)156(1)(2)B(5)	1.0	8.0	3.2	1
6	15	D/1510	T429D156(1)006(2)(3)(4)	CWR29D(3)156(1)(2)D(5)	1.0	8.0	1.7	1
6	15	E/2010	T429E156(1)006(2)(3)(4)	CWR29D(3)156(1)(2)E(5)	1.0	8.0	0.9	1
6	22	D/1510	T429D226(1)006(2)(3)(4)	CWR29D(3)226(1)(2)D(5)	1.0	6.0	1.7	1
6	22	E/2010	T429E226(1)006(2)(3)(4)	CWR29D(3)226(1)(2)E(5)	2.0	8.0	1.0	1
6	22	F/2214	T429F226(1)006(2)(3)(4)	CWR29D(3)226(1)(2)F(5)	2.0	8.0	0.6	1
6	33	E/2010	T429E336(1)006(2)(3)(4)	CWR29D(3)336(1)(2)E(5)	2.0	6.0	1.0	1
6	47	F/2214	T429F476(1)006(2)(3)(4)	CWR29D(3)476(1)(2)F(5)	3.0	8.0	1.0	1
6	47	G/2711	T429G476(1)006(2)(3)(4)	CWR29D(3)476(1)(2)G(5)	3.0	10.0	0.275	1
6	68	F/2214	T429F686(1)006(2)(3)(4)	CWR29D(3)686(1)(2)F(5)	4.0	10.0	0.4	1
6	68	G/2711	T429G686(1)006(2)(3)(4)	CWR29D(3)686(1)(2)G(5)	4.0	10.0	0.25	1
6	68	H/2915	T429H686(1)006(2)(3)(4)	CWR29D(3)686(1)(2)H(5)	4.0	10.0	0.18	1
6	100	G/2711	T429G107(1)006(2)(3)(4)	CWR29D(3)107(1)(2)G(5)	6.0	10.0	0.275	1
6	150	G/2711	T429G157(1)006(2)(3)(4)	CWR29D(3)157(1)(2)G(5)	10.0	10.0	0.275	1
6	220	H/2915	T429H227(1)006(2)(3)(4)	CWR29D(3)227(1)(2)H(5)	10.0	10.0	0.18	1
6	330	H/2915	T429H337(1)006(2)(3)(4)	CWR29D(3)337(1)(2)H(5)	20.0	10.0	0.18	1
VDC	µF	KEMET/EIA	(See below for part options)	(See below for part options)	µA @ +20°C Max/5 Min	% @ +20°C 120 Hz Max	Ω @ +20°C 100 kHz Max	Reflow Temperature ≤ 260°C
Rated Voltage	Rated Cap	Case Code/ Case Size	KEMET Part Number	MIL-PRF-55365/11 Part Number	DC Leakage	DF	ESR	Moisture Sensitivity

(1) To complete KEMET/CWR part number, insert M for ±20%, K for ±10%, or J for ±5%. Designates Capacitance tolerance.

(2) To complete KEMET/CWR part number, insert failure rate letter per the Ordering Information found on page 2. Designates Reliability Level.

(3) To complete KEMET/CWR part number, insert B = Gold Plated, C = Hot solder dipped, H = Solder plated or K = Solder Fused. Designates Termination Finish.

(4) To complete KEMET part number, insert 4250 = +25°C after Weibull, 4251 = -55°C +85°C after Weibull, or 4252 = -55°C +85°C before Weibull. Designates Surge current option.

(5) To complete CWR part number, insert A = +25°C after Weibull, B = -55°C +85°C after Weibull, C = -55°C +85°C before Weibull or Z = None. Designates Surge current option.

Refer to Ordering Information for additional detail.

Table 1 – Ratings & Part Number Reference cont'd

Rated Voltage	Rated Cap	Case Code/ Case Size	KEMET Part Number	MIL-PRF-55365/11 Part Number	DC Leakage	DF	ESR	Moisture Sensitivity
VDC	µF	KEMET/EIA	(See below for part options)	(See below for part options)	µA @ +20°C Max/5 Min	% @ +20°C 120 Hz Max	Ω @ +20°C 100 kHz Max	Reflow Temperature ≤ 260°C
10	1	A/1005	T429A105(1)010(2)(3)(4)	CWR29F(3)105(1)(2)A(5)	1.0	6.0	5.0	1
10	2.2	A/1005	T429A225(1)010(2)(3)(4)	CWR29F(3)225(1)(2)A(5)	1.0	6.0	6.0	1
10	2.2	B/1505	T429B225(1)010(2)(3)(4)	CWR29F(3)225(1)(2)B(5)	1.0	6.0	3.2	1
10	3.3	A/1005	T429A335(1)010(2)(3)(4)	CWR29F(3)335(1)(2)A(5)	1.0	6.0	6.0	1
10	3.3	C/2005	T429C335(1)010(2)(3)(4)	CWR29F(3)335(1)(2)C(5)	1.0	6.0	2.2	1
10	4.7	B/1505	T429B475(1)010(2)(3)(4)	CWR29F(3)475(1)(2)B(5)	1.0	6.0	3.2	1
10	4.7	C/2005	T429C475(1)010(2)(3)(4)	CWR29F(3)475(1)(2)C(5)	1.0	6.0	2.2	1
10	4.7	D/1510	T429D475(1)010(2)(3)(4)	CWR29F(3)475(1)(2)D(5)	1.0	6.0	1.5	1
10	6.8	B/1505	T429B685(1)010(2)(3)(4)	CWR29F(3)685(1)(2)B(5)	1.0	6.0	3.2	1
10	6.8	C/2005	T429C685(1)010(2)(3)(4)	CWR29F(3)685(1)(2)C(5)	1.0	6.0	2.2	1
10	6.8	D/1510	T429D685(1)010(2)(3)(4)	CWR29F(3)685(1)(2)D(5)	1.0	6.0	1.7	1
10	6.8	E/2010	T429E685(1)010(2)(3)(4)	CWR29F(3)685(1)(2)E(5)	1.0	6.0	1.0	1
10	10	B/1505	T429B106(1)010(2)(3)(4)	CWR29F(3)106(1)(2)B(5)	1.0	8.0	3.2	1
10	10	C/2005	T429C106(1)010(2)(3)(4)	CWR29F(3)106(1)(2)C(5)	1.0	6.0	2.2	1
10	10	D/1510	T429D106(1)010(2)(3)(4)	CWR29F(3)106(1)(2)D(5)	1.0	6.0	1.3	1
10	10	E/2010	T429E106(1)010(2)(3)(4)	CWR29F(3)106(1)(2)E(5)	1.0	6.0	1.0	1
10	15	D/1510	T429D156(1)010(2)(3)(4)	CWR29F(3)156(1)(2)D(5)	2.0	6.0	1.7	1
10	15	E/2010	T429E156(1)010(2)(3)(4)	CWR29F(3)156(1)(2)E(5)	2.0	8.0	0.9	1
10	15	F/2214	T429F156(1)010(2)(3)(4)	CWR29F(3)156(1)(2)F(5)	2.0	8.0	0.7	1
10	22	E/2010	T429E226(1)010(2)(3)(4)	CWR29F(3)226(1)(2)E(5)	3.0	8.0	0.6	1
10	33	F/2214	T429F336(1)010(2)(3)(4)	CWR29F(3)336(1)(2)F(5)	3.0	8.0	0.4	1
10	33	G/2711	T429G336(1)010(2)(3)(4)	CWR29F(3)336(1)(2)G(5)	3.0	10.0	0.275	1
10	47	F/2214	T429F476(1)010(2)(3)(4)	CWR29F(3)476(1)(2)F(5)	4.0	10.0	0.4	1
10	47	G/2711	T429G476(1)010(2)(3)(4)	CWR29F(3)476(1)(2)G(5)	4.0	10.0	0.25	1
10	47	H/2915	T429H476(1)010(2)(3)(4)	CWR29F(3)476(1)(2)H(5)	5.0	10.0	0.18	1
10	68	G/2711	T429G686(1)010(2)(3)(4)	CWR29F(3)686(1)(2)G(5)	6.0	10.0	0.275	1
10	100	G/2711	T429G107(1)010(2)(3)(4)	CWR29F(3)107(1)(2)G(5)	10.0	10.0	0.275	1
10	100	H/2915	T429H107(1)010(2)(3)(4)	CWR29F(3)107(1)(2)H(5)	10.0	10.0	0.18	1
10	150	H/2915	T429H157(1)010(2)(3)(4)	CWR29F(3)157(1)(2)H(5)	15.0	10.0	0.18	1
10	150	X/2824	T429X157(1)010(2)(3)(4)	CWR29F(3)157(1)(2)X(5)	15.0	10.0	0.065	1
10	220	H/2915	T429H227(1)010(2)(3)(4)	CWR29F(3)227(1)(2)H(5)	20.0	10.0	0.18	1
15	0.68	A/1005	T429A684(1)015(2)(3)(4)	CWR29H(3)684(1)(2)A(5)	1.0	6.0	6.0	1
15	1	A/1005	T429A105(1)015(2)(3)(4)	CWR29H(3)105(1)(2)A(5)	1.0	6.0	7.5	1
15	1.5	A/1005	T429A155(1)015(2)(3)(4)	CWR29H(3)155(1)(2)A(5)	1.0	6.0	7.5	1
15	1.5	B/1505	T429B155(1)015(2)(3)(4)	CWR29H(3)155(1)(2)B(5)	1.0	6.0	3.2	1
15	2.2	A/1005	T429A225(1)015(2)(3)(4)	CWR29H(3)225(1)(2)A(5)	1.0	6.0	7.5	1
15	2.2	C/2005	T429C225(1)015(2)(3)(4)	CWR29H(3)225(1)(2)C(5)	1.0	6.0	2.2	1
15	3.3	B/1505	T429B335(1)015(2)(3)(4)	CWR29H(3)335(1)(2)B(5)	1.0	6.0	3.6	1
15	3.3	D/1510	T429D335(1)015(2)(3)(4)	CWR29H(3)335(1)(2)D(5)	1.0	6.0	1.7	1
15	4.7	B/1505	T429B475(1)015(2)(3)(4)	CWR29H(3)475(1)(2)B(5)	1.0	6.0	2.0	1
15	4.7	C/2005	T429C475(1)015(2)(3)(4)	CWR29H(3)475(1)(2)C(5)	1.0	6.0	2.2	1
15	4.7	D/1510	T429D475(1)015(2)(3)(4)	CWR29H(3)475(1)(2)D(5)	1.0	6.0	2.0	1
15	4.7	E/2010	T429E475(1)015(2)(3)(4)	CWR29H(3)475(1)(2)E(5)	1.0	6.0	1.2	1
15	6.8	D/1510	T429D685(1)015(2)(3)(4)	CWR29H(3)685(1)(2)D(5)	1.0	6.0	2.0	1
15	6.8	E/2010	T429E685(1)015(2)(3)(4)	CWR29H(3)685(1)(2)E(5)	1.0	8.0	0.9	1
15	10	D/1510	T429D106(1)015(2)(3)(4)	CWR29H(3)106(1)(2)D(5)	2.0	6.0	2.0	1
15	10	E/2010	T429E106(1)015(2)(3)(4)	CWR29H(3)106(1)(2)E(5)	2.0	6.0	1.2	1
15	10	F/2214	T429F106(1)015(2)(3)(4)	CWR29H(3)106(1)(2)F(5)	2.0	6.0	0.667	1
VDC	µF	KEMET/EIA	(See below for part options)	(See below for part options)	µA @ +20°C Max/5 Min	% @ +20°C 120 Hz Max	Ω @ +20°C 100 kHz Max	Reflow Temperature ≤ 260°C
Rated Voltage	Rated Cap	Case Code/ Case Size	KEMET Part Number	MIL-PRF-55365/11 Part Number	DC Leakage	DF	ESR	Moisture Sensitivity

(1) To complete KEMET/CWR part number, insert M for ±20%, K for ±10%, or J for ±5%. Designates Capacitance tolerance.

(2) To complete KEMET/CWR part number, insert failure rate letter per the Ordering Information found on page 2. Designates Reliability Level.

(3) To complete KEMET/CWR part number, insert B = Gold Plated, C = Hot solder dipped, H = Solder plated or K = Solder Fused. Designates Termination Finish.

(4) To complete KEMET part number, insert 4250 = +25°C after Weibull, 4251 = -55°C +85°C after Weibull, or 4252 = -55°C +85°C before Weibull. Designates Surge current option.

(5) To complete CWR part number, insert A = +25°C after Weibull, B = -55°C +85°C after Weibull, C = -55°C +85°C before Weibull or Z = None. Designates Surge current option.

Refer to Ordering Information for additional detail.

Table 1 – Ratings & Part Number Reference cont'd

Rated Voltage	Rated Cap	Case Code/ Case Size	KEMET Part Number	MIL-PRF-55365/11 Part Number	DC Leakage	DF	ESR	Moisture Sensitivity
VDC	µF	KEMET/EIA	(See below for part options)	(See below for part options)	µA @ +20°C Max/5 Min	% @ +20°C 120 Hz Max	Ω @ +20°C 100 kHz Max	Reflow Temperature ≤ 260°C
15	15	E/2010	T429E156(1)015(2)(3)(4)	CWR29H(3)156(1)(2)E(5)	2.0	6.0	1.2	1
15	15	F/2214	T429F156(1)015(2)(3)(4)	CWR29H(3)156(1)(2)F(5)	2.0	8.0	0.8	1
15	22	F/2214	T429F226(1)015(2)(3)(4)	CWR29H(3)226(1)(2)F(5)	3.0	8.0	0.8	1
15	22	G/2711	T429G226(1)015(2)(3)(4)	CWR29H(3)226(1)(2)G(5)	4.0	6.0	0.3	1
15	33	F/2214	T429F336(1)015(2)(3)(4)	CWR29H(3)336(1)(2)F(5)	5.0	6.0	0.8	1
15	33	G/2711	T429G336(1)015(2)(3)(4)	CWR29H(3)336(1)(2)G(5)	6.0	8.0	0.3	1
15	33	H/2915	T429H336(1)015(2)(3)(4)	CWR29H(3)336(1)(2)H(5)	5.0	8.0	0.2	1
15	47	G/2711	T429G476(1)015(2)(3)(4)	CWR29H(3)476(1)(2)G(5)	10.0	8.0	0.3	1
15	47	H/2915	T429H476(1)015(2)(3)(4)	CWR29H(3)476(1)(2)H(5)	10.0	8.0	0.2	1
15	68	G/2711	T429G686(1)015(2)(3)(4)	CWR29H(3)686(1)(2)G(5)	10.0	8.0	0.3	1
15	68	H/2915	T429H686(1)015(2)(3)(4)	CWR29H(3)686(1)(2)H(5)	10.0	8.0	0.2	1
15	100	H/2915	T429H107(1)015(2)(3)(4)	CWR29H(3)107(1)(2)H(5)	15.0	10.0	0.2	1
20	0.47	A/1005	T429A474(1)020(2)(3)(4)	CWR29J(3)474(1)(2)A(5)	1.0	8.0	7.5	1
20	0.68	A/1005	T429A684(1)020(2)(3)(4)	CWR29J(3)684(1)(2)A(5)	1.0	6.0	7.5	1
20	0.68	B/1505	T429B684(1)020(2)(3)(4)	CWR29J(3)684(1)(2)B(5)	1.0	6.0	5.6	1
20	1	A/1005	T429A105(1)020(2)(3)(4)	CWR29J(3)105(1)(2)A(5)	1.0	6.0	7.5	1
20	1	B/1505	T429B105(1)020(2)(3)(4)	CWR29J(3)105(1)(2)B(5)	1.0	6.0	4.8	1
20	1.5	B/1505	T429B155(1)020(2)(3)(4)	CWR29J(3)155(1)(2)B(5)	1.0	6.0	3.6	1
20	1.5	C/2005	T429C155(1)020(2)(3)(4)	CWR29J(3)155(1)(2)C(5)	1.0	6.0	2.4	1
20	2.2	B/1505	T429B225(1)020(2)(3)(4)	CWR29J(3)225(1)(2)B(5)	1.0	6.0	3.6	1
20	2.2	D/1510	T429D225(1)020(2)(3)(4)	CWR29J(3)225(1)(2)D(5)	1.0	6.0	1.7	1
20	3.3	D/1510	T429D335(1)020(2)(3)(4)	CWR29J(3)335(1)(2)D(5)	1.0	6.0	2.0	1
20	3.3	E/2010	T429E335(1)020(2)(3)(4)	CWR29J(3)335(1)(2)E(5)	1.0	6.0	1.2	1
20	4.7	E/2010	T429E475(1)020(2)(3)(4)	CWR29J(3)475(1)(2)E(5)	1.0	6.0	1.7	1
20	6.8	E/2010	T429E685(1)020(2)(3)(4)	CWR29J(3)685(1)(2)E(5)	2.0	6.0	1.5	1
20	6.8	F/2214	T429F685(1)020(2)(3)(4)	CWR29J(3)685(1)(2)F(5)	2.0	6.0	0.7	1
20	10	E/2010	T429E106(1)020(2)(3)(4)	CWR29J(3)106(1)(2)E(5)	2.0	6.0	1.5	1
20	10	F/2214	T429F106(1)020(2)(3)(4)	CWR29J(3)106(1)(2)F(5)	2.0	6.0	0.8	1
20	15	F/2214	T429F156(1)020(2)(3)(4)	CWR29J(3)156(1)(2)F(5)	3.0	6.0	0.8	1
20	15	G/2711	T429G156(1)020(2)(3)(4)	CWR29J(3)156(1)(2)G(5)	3.0	6.0	0.275	1
20	22	G/2711	T429G226(1)020(2)(3)(4)	CWR29J(3)226(1)(2)G(5)	4.0	6.0	0.625	1
20	22	H/2915	T429H226(1)020(2)(3)(4)	CWR29J(3)226(1)(2)H(5)	4.0	6.0	0.18	1
20	33	H/2915	T429H336(1)020(2)(3)(4)	CWR29J(3)336(1)(2)H(5)	6.0	8.0	0.18	1
20	47	H/2915	T429H476(1)020(2)(3)(4)	CWR29J(3)476(1)(2)H(5)	10.0	8.0	0.18	1
20	47	X/2824	T429X476(1)020(2)(3)(4)	CWR29J(3)476(1)(2)X(5)	10.0	8.0	0.11	1
25	0.33	A/1005	T429A334(1)025(2)(3)(4)	CWR29K(3)334(1)(2)A(5)	1.0	6.0	7.5	1
25	0.47	A/1005	T429A474(1)025(2)(3)(4)	CWR29K(3)474(1)(2)A(5)	1.0	6.0	7.5	1
25	0.68	B/1505	T429B684(1)025(2)(3)(4)	CWR29K(3)684(1)(2)B(5)	1.0	6.0	4.0	1
25	1	B/1505	T429B105(1)025(2)(3)(4)	CWR29K(3)105(1)(2)B(5)	1.0	6.0	4.0	1
25	1	C/2005	T429C105(1)025(2)(3)(4)	CWR29K(3)105(1)(2)C(5)	1.0	6.0	2.6	1
25	1.5	D/1510	T429D155(1)025(2)(3)(4)	CWR29K(3)155(1)(2)D(5)	1.0	6.0	1.7	1
25	2.2	D/1510	T429D225(1)025(2)(3)(4)	CWR29K(3)225(1)(2)D(5)	1.0	6.0	2.0	1
25	2.2	E/2010	T429E225(1)025(2)(3)(4)	CWR29K(3)225(1)(2)E(5)	1.0	6.0	1.0	1
25	3.3	E/2010	T429E335(1)025(2)(3)(4)	CWR29K(3)335(1)(2)E(5)	1.0	6.0	1.2	1
25	4.7	F/2214	T429F475(1)025(2)(3)(4)	CWR29K(3)475(1)(2)F(5)	2.0	6.0	0.7	1
25	6.8	F/2214	T429F685(1)025(2)(3)(4)	CWR29K(3)685(1)(2)F(5)	2.0	6.0	0.8	1
25	6.8	G/2711	T429G685(1)025(2)(3)(4)	CWR29K(3)685(1)(2)G(5)	2.0	6.0	0.3	1
25	10	G/2711	T429G106(1)025(2)(3)(4)	CWR29K(3)106(1)(2)G(5)	3.0	6.0	0.35	1
VDC	µF	KEMET/EIA	(See below for part options)	(See below for part options)	µA @ +20°C Max/5 Min	% @ +20°C 120 Hz Max	Ω @ +20°C 100 kHz Max	Reflow Temperature ≤ 260°C
Rated Voltage	Rated Cap	Case Code/ Case Size	KEMET Part Number	MIL-PRF-55365/11 Part Number	DC Leakage	DF	ESR	Moisture Sensitivity

(1) To complete KEMET/CWR part number, insert M for ±20%, K for ±10%, or J for ±5%. Designates Capacitance tolerance.

(2) To complete KEMET/CWR part number, insert failure rate letter per the Ordering Information found on page 2. Designates Reliability Level.

(3) To complete KEMET/CWR part number, insert B = Gold Plated, C = Hot solder dipped, H = Solder plated or K = Solder Fused. Designates Termination Finish.

(4) To complete KEMET part number, insert 4250 = +25°C after Weibull, 4251 = -55°C +85°C after Weibull, or 4252 = -55°C +85°C before Weibull. Designates Surge current option.

(5) To complete CWR part number, insert A = +25°C after Weibull, B = -55°C +85°C after Weibull, C = -55°C +85°C before Weibull or Z = None. Designates Surge current option.

Refer to Ordering Information for additional detail.

Table 1 – Ratings & Part Number Reference cont'd

Rated Voltage	Rated Cap	Case Code/ Case Size	KEMET Part Number	MIL-PRF-55365/11 Part Number	DC Leakage	DF	ESR	Moisture Sensitivity
VDC	µF	KEMET/EIA	(See below for part options)	(See below for part options)	µA @ +20°C Max/5 Min	% @ +20°C 120 Hz Max	Ω @ +20°C 100 kHz Max	Reflow Temperature ≤ 260°C
25	15	G/2711	T429G156(1)025(2)(3)(4)	CWR29K(3)156(1)(2)G(5)	4.0	6.0	0.35	1
25	15	H/2915	T429H156(1)025(2)(3)(4)	CWR29K(3)156(1)(2)H(5)	4.0	6.0	0.2	1
25	22	G/2711	T429G226(1)025(2)(3)(4)	CWR29K(3)226(1)(2)G(5)	6.0	6.0	0.35	1
25	22	H/2915	T429H226(1)025(2)(3)(4)	CWR29K(3)226(1)(2)H(5)	6.0	6.0	0.18	1
25	22	X/2824	T429X226(1)025(2)(3)(4)	CWR29K(3)226(1)(2)X(5)	6.0	6.0	0.16	1
25	33	H/2915	T429H336(1)025(2)(3)(4)	CWR29K(3)336(1)(2)H(5)	10.0	8.0	0.18	1
25	33	X/2824	T429X336(1)025(2)(3)(4)	CWR29K(3)336(1)(2)X(5)	10.0	8.0	0.13	1
35	0.22	A/1005	T429A224(1)035(2)(3)(4)	CWR29M(3)224(1)(2)A(5)	1.0	6.0	12.0	1
35	0.33	A/1005	T429A334(1)035(2)(3)(4)	CWR29M(3)334(1)(2)A(5)	1.0	6.0	12.0	1
35	0.47	B/1505	T429B474(1)035(2)(3)(4)	CWR29M(3)474(1)(2)B(5)	1.0	6.0	6.8	1
35	0.68	C/2005	T429C684(1)035(2)(3)(4)	CWR29M(3)684(1)(2)C(5)	1.0	6.0	4.0	1
35	1	D/1510	T429D105(1)035(2)(3)(4)	CWR29M(3)105(1)(2)D(5)	1.0	6.0	2.2	1
35	1.5	E/2010	T429E155(1)035(2)(3)(4)	CWR29M(3)155(1)(2)E(5)	1.0	6.0	1.3	1
35	3.3	F/2214	T429F335(1)035(2)(3)(4)	CWR29M(3)335(1)(2)F(5)	1.0	6.0	0.7	1
35	4.7	G/2711	T429G475(1)035(2)(3)(4)	CWR29M(3)475(1)(2)G(5)	2.0	6.0	0.375	1
35	6.8	F/2214	T429F685(1)035(2)(3)(4)	CWR29M(3)685(1)(2)F(5)	3.0	6.0	0.375	1
35	6.8	H/2915	T429H685(1)035(2)(3)(4)	CWR29M(3)685(1)(2)H(5)	3.0	6.0	0.5	1
35	10	H/2915	T429H106(1)035(2)(3)(4)	CWR29M(3)106(1)(2)H(5)	4.0	8.0	0.5	1
35	15	X/2824	T429X156(1)035(2)(3)(4)	CWR29M(3)156(1)(2)X(5)	6.0	6.0	0.19	1
50	0.1	A/1005	T429A104(1)050(2)(3)(4)	CWR29N(3)104(1)(2)A(5)	1.0	6.0	12.0	1
50	0.15	A/1005	T429A154(1)050(2)(3)(4)	CWR29N(3)154(1)(2)A(5)	1.0	6.0	12.0	1
50	0.22	B/1505	T429B224(1)050(2)(3)(4)	CWR29N(3)224(1)(2)B(5)	1.0	6.0	6.8	1
50	0.33	B/1505	T429B334(1)050(2)(3)(4)	CWR29N(3)334(1)(2)B(5)	1.0	6.0	4.8	1
50	0.47	C/2005	T429C474(1)050(2)(3)(4)	CWR29N(3)474(1)(2)C(5)	1.0	6.0	3.2	1
50	0.68	D/1510	T429D684(1)050(2)(3)(4)	CWR29N(3)684(1)(2)D(5)	1.0	6.0	2.3	1
50	1	E/2010	T429E105(1)050(2)(3)(4)	CWR29N(3)105(1)(2)E(5)	1.0	6.0	1.7	1
50	1.5	F/2214	T429F155(1)050(2)(3)(4)	CWR29N(3)155(1)(2)F(5)	1.0	6.0	1.1	1
50	2.2	F/2214	T429F225(1)050(2)(3)(4)	CWR29N(3)225(1)(2)F(5)	2.0	6.0	0.7	1
50	3.3	G/2711	T429G335(1)050(2)(3)(4)	CWR29N(3)335(1)(2)G(5)	2.0	6.0	0.5	1
50	4.7	H/2915	T429H475(1)050(2)(3)(4)	CWR29N(3)475(1)(2)H(5)	3.0	6.0	0.5	1
VDC	µF	KEMET/EIA	(See below for part options)	(See below for part options)	µA @ +20°C Max/5 Min	% @ +20°C 120 Hz Max	Ω @ +20°C 100 kHz Max	Reflow Temperature ≤ 260°C
Rated Voltage	Rated Cap	Case Code/ Case Size	KEMET Part Number	MIL-PRF-55365/11 Part Number	DC Leakage	DF	ESR	Moisture Sensitivity

(1) To complete KEMET/CWR part number, insert M for ±20%, K for ±10%, or J for ±5%. Designates Capacitance tolerance.

(2) To complete KEMET/CWR part number, insert failure rate letter per the Ordering Information found on page 2. Designates Reliability Level.

(3) To complete KEMET/CWR part number, insert B = Gold Plated, C = Hot solder dipped, H = Solder plated or K = Solder Fused. Designates Termination Finish.

(4) To complete KEMET part number, insert 4250 = +25°C after Weibull, 4251 = -55°C +85°C after Weibull, or 4252 = -55°C +85°C before Weibull. Designates Surge current option.

(5) To complete CWR part number, insert A = +25°C after Weibull, B = -55°C +85°C after Weibull, C = -55°C +85°C before Weibull or Z = None. Designates Surge current option.

Refer to Ordering Information for additional detail.

Recommended Voltage Derating Guidelines

	-55°C to 85°C	85°C to 125°C
% Change in Working DC Voltage with Temperature	V_R	67% of V_R
Recommended Maximum Application Voltage	50% of V_R	33% of V_R

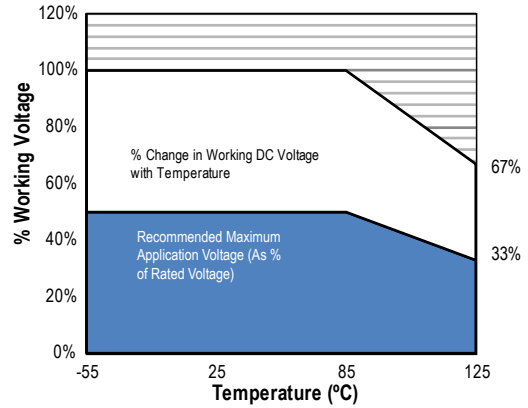

Ripple Current/Ripple Voltage

Permissible AC ripple voltage and current are related to equivalent series resistance (ESR) and the power dissipation capabilities of the device. Permissible AC ripple voltage which may be applied is limited by two criteria:

1. The positive peak AC voltage plus the DC bias voltage, if any, must not exceed the DC voltage rating of the capacitor.
2. The negative peak AC voltage in combination with bias voltage, if any, must not exceed the allowable limits specified for reverse voltage. See the Reverse Voltage section for allowable limits.

The maximum power dissipation by case size can be determined using the table at right. The maximum power dissipation rating stated in the table must be reduced with increasing environmental operating temperatures. Refer to the table below for temperature compensation requirements.

KEMET Case Code	EIA Case Code	Maximum Power Dissipation (P max) mWatts @ 25°C w/+20°C Rise
A	1005	50
B	1505	70
C	2005	75
D	1510	80
E	2010	90
F	2214	100
G	2711	125
H	2915	150

The maximum power dissipation rating must be reduced with increasing environmental operating temperatures. Refer to the Temperature Compensation Multiplier table for details.

Temperature Compensation Multipliers for Maximum Power Dissipation		
T ≤ 25°C	T ≤ 85°C	T ≤ 125°C
1.00	0.90	0.40

T = Environmental Temperature

Using the P max of the device, the maximum allowable rms ripple current or voltage may be determined.

$$I(max) = \sqrt{P_{max}/R}$$

$$E(max) = Z \sqrt{P_{max}/R}$$

I = rms ripple current (amperes)

E = rms ripple voltage (volts)

P max = maximum power dissipation (watts)

R = ESR at specified frequency (ohms)

Z = Impedance at specified frequency (ohms)

Reverse Voltage

Solid tantalum capacitors are polar devices and may be permanently damaged or destroyed if connected with the wrong polarity. The positive terminal is identified on the capacitor body by a stripe plus in some cases a beveled edge. A small degree of transient reverse voltage is permissible for short periods per the table. The capacitors should not be operated continuously in reverse mode, even within these limits.

Temperature	Permissible Transient Reverse Voltage
25°C	15% of Rated Voltage
85°C	5% of Rated Voltage
125°C	1% of Rated Voltage

Table 2 – Land Dimensions/Courtyard

KEMET	Metric Size Code	Density Level A: Maximum (Most) Land Protrusion (mm)					Density Level B: Median (Nominal) Land Protrusion (mm)					Density Level C: Minimum (Least) Land Protrusion (mm)				
		L	W	S	V1	V2	L	W	S	V1	V2	L	W	S	V1	V2
A ¹	1005	2.19	1.44	0.15	5.54	2.66	1.89	1.32	0.15	4.44	2.16	1.52	1.22	0.29	3.58	1.90
B	1505	2.30	1.44	1.20	6.80	2.66	1.90	1.32	1.40	5.70	2.16	1.52	1.22	1.56	4.84	1.90
C	2005	2.30	1.44	2.47	8.08	2.66	1.90	1.32	2.67	6.98	2.16	1.52	1.22	2.83	6.12	1.90
D	1510	2.30	2.58	1.20	6.80	3.92	1.90	2.46	1.40	5.70	3.42	1.52	2.36	1.56	4.84	3.16
E	2010	2.30	2.58	2.47	8.08	3.92	1.90	2.46	2.67	6.98	3.42	1.52	2.36	2.83	6.12	3.16
F	2214	2.30	3.47	2.98	8.58	4.82	1.90	3.35	3.18	7.48	4.32	1.52	3.25	3.34	6.62	4.06
G	2711	2.81	2.84	3.10	9.72	4.18	2.41	2.72	3.30	8.62	3.68	2.03	2.62	3.46	7.76	3.42
H	2915	2.81	3.84	3.61	10.24	5.20	2.41	3.72	3.81	9.14	4.70	2.03	3.62	3.97	8.28	4.44
X	2824	2.73	3.22	3.46	9.92	6.80	2.33	3.10	3.66	8.82	6.30	1.95	3.00	3.82	7.96	6.04

Density Level A: For low-density product applications. Recommended for wave solder applications and provides a wider process window for reflow solder processes.

Density Level B: For products with a moderate level of component density. Provides a robust solder attachment condition for reflow solder processes.

Density Level C: For high component density product applications. Before adapting the minimum land pattern variations the user should perform qualification testing based on the conditions outlined in IPC standard 7351 (IPC-7351).

¹ Land pattern geometry is too small for silkscreen outline.

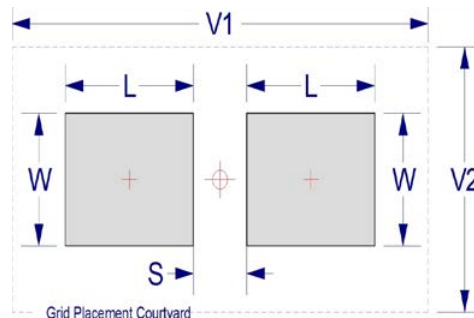

Soldering Process

KEMET's families of surface mount capacitors are compatible with wave (single or dual), convection, IR, or vapor phase reflow techniques. Preheating of these components is recommended to avoid extreme thermal stress. KEMET's recommended profile conditions for convection and IR reflow reflect the profile conditions of the IPC/J-STD-020D standard for moisture sensitivity testing. The devices can safely withstand a maximum of three reflow passes at these conditions.

Note that although the X/7343-43 case size can withstand wave soldering, the tall profile (4.3 mm maximum) dictates care in wave process development.

Hand soldering should be performed with care due to the difficulty in process control. If performed, care should be taken to avoid contact of the soldering iron to the molded case. The iron should be used to heat the solder pad, applying solder between the pad and the termination, until reflow occurs. Once reflow occurs, the iron should be removed immediately. "Wiping" the edges of a chip and heating the top surface is not recommended.

During typical reflow operations, a slight darkening of the gold-colored epoxy may be observed. This slight darkening is normal and not harmful to the product. Marking permanency is not affected by this change.

Profile Feature	SnPb Assembly	Pb-Free Assembly
Preheat/Soak		
Temperature Minimum (T_{Smin})	100°C	150°C
Temperature Maximum (T_{Smax})	150°C	200°C
Time (t_s) from T_{Smin} to T_{Smax}	60 – 120 seconds	60 – 120 seconds
Ramp-up Rate (T_L to T_P)	3°C/seconds maximum	3°C/seconds maximum
Liquidous Temperature (T_L)	183°C	217°C
Time Above Liquidous (t_L)	60 – 150 seconds	60 – 150 seconds
Peak Temperature (T_P)	220°C* 235°C**	250°C* 260°C**
Time within 5°C of Maximum Peak Temperature (t_p)	20 seconds maximum	30 seconds maximum
Ramp-down Rate (T_P to T_L)	6°C/seconds maximum	6°C/seconds maximum
Time 25°C to Peak Temperature	6 minutes maximum	8 minutes maximum

Note: All temperatures refer to the center of the package, measured on the package body surface that is facing up during assembly reflow.

*Case Size D, E, P, Y, and X

**Case Size A, B, C, H, I, K, M, R, S, T, U, V, W, and Z

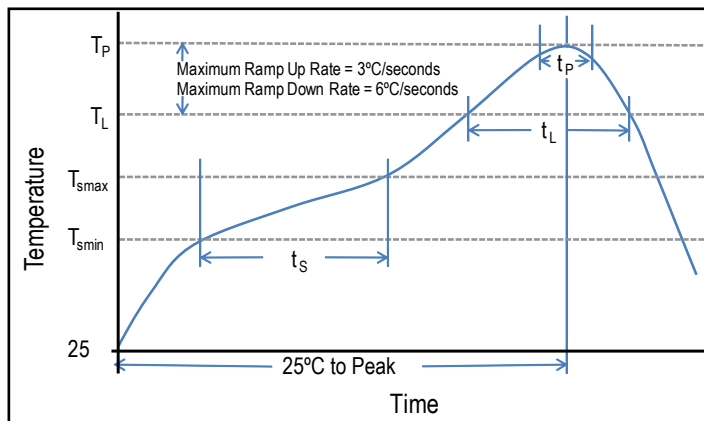

Construction

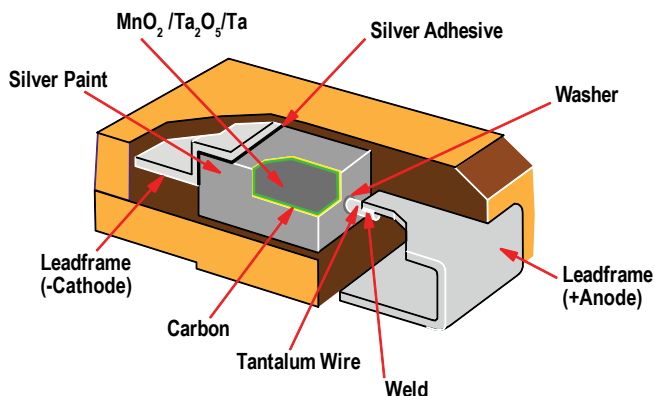

Capacitor Marking

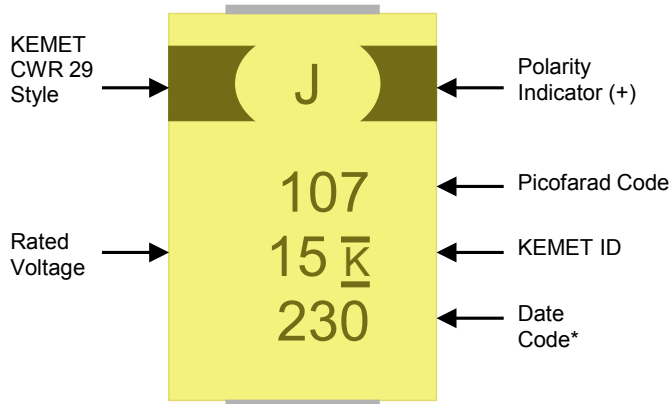

* 230 = 30th week of 2012

Date Code *	
1 st digit = Last number of Year	9 = 2009 0 = 2010 1 = 2011 2 = 2012 3 = 2013 4 = 2014
2 nd and 3 rd digit = Week of the Year	01 = 1 st week of the Year to 52 = 52 nd week of the Year

Storage

Tantalum chip capacitors should be stored in normal working environments. While the chips themselves are quite robust in other environments, solderability will be degraded by exposure to high temperatures, high humidity, corrosive atmospheres, and long term storage. In addition, packaging materials will be degraded by high temperature– reels may soften or warp and tape peel force may increase. KEMET recommends that maximum storage temperature not exceed 40°C and maximum storage humidity not exceed 60% relative humidity. Temperature fluctuations should be minimized to avoid condensation on the parts and atmospheres should be free of chlorine and sulphur bearing compounds. For optimized solderability chip stock should be used promptly, preferably within three years of receipt.

Overview

The KEMET T492 Series is approved to MIL-PRF-55365/8 (CWR11) with Weibull failure rates of B level (0.1% failures per 1,000 hours), C level (0.01% failures per 1,000 hours), D level (0.001% failures per 1,000 hours), or T level (0.01% failures per 1,000 hours), Option C surge current, DPA, Radiographic inspection, 100% visual inspection, DCL and ESR measure-

ments within +3 standard deviations, and Group C inspection). This CWR11 product is a precision-molded device with compliant terminations and indelible laser marking. This is the military version of the global IEC/EIA standard represented by KEMET's T491 Series. Tape and reeling per EIA 481-1 is standard.

Benefits

- Established reliability options
- Taped and reeled per EIA 481-1
- Symmetrical, compliant terminations
- Laser-marked case
- 100% surge current test available on all case sizes
- Qualified to MIL-PRF-55365/8, Style CWR11
- Termination options B, C, H, K
- Weibull failure options B, C, D, and T
- Exponential failure rates M, P, R, S
- Voltage rating of 4 – 50 VDC
- Operating temperature range of -55°C to +125°C

Applications

Typical applications include decoupling and filtering in military and aerospace applications requiring CWR11 devices.



Environmental Compliance

RoHS Compliant (6/6) according to Directive 2002/95/EC when ordered with 100% Sn Solder.



RoHS Compliant

SPICE

For a detailed analysis of specific part numbers, please visit www.kemet.com for a free download of KEMET's SPICE software. The KEMET SPICE program is freeware intended to aid design engineers in analyzing the performance of these capacitors over frequency, temperature, ripple, and DC bias conditions.

KEMET Ordering Information

T	492	D	156	K	020	A	C	4251
Capacitor Class	Series	Case Size	Capacitance Code (pF)	Capacitance Tolerance	Voltage	Failure Rate/Design	Lead Material	Surge (C-Spec)
T = Tantalum	CWR11 Established Reliability	A, B, C, D	First two digits represent significant figures. Third digit specifies number of zeros.	J = ±5% K = ±10% M = ±20%	006 = 6.3 V 010 = 10 V 015 = 15 V 020 = 20 V 025 = 25 V 035 = 35 V 050 = 50 V	Weibull A = non-ER B = (0.1%/1,000 hours) C = (0.01%/1,000 hours) D = (0.001%/1,000 hours) T = (0.01%/1,000 hours) Exponential M = (1.0%/1,000 hours) P = (0.1%/1,000 hours) R = (0.01%/1,000 hours) S = (0.001%/1,000 hours)	C = Hot Solder Dipped H = Standard Solder Coated (SnPb 5% Pb minimum) B = Gold Plated K = Solder Fused	4250 = 25°C after Weibull 4251 = -55°C and 85°C after Weibull 4252 = -55°C and 85°C before Weibull TLVL = Weibull Grade Level "T"

Defense MIL–PRF–55365/8 Ordering Information

CWR11	M	H	105	K	B	A
Capacitor Style	Voltage	Termination Finish	Capacitance Code (pF)	Capacitance Tolerance	Reliability Level	Surge Current Option
Per MIL–PRF–55365/8	C = 4 V D = 6 V F = 10 V H = 15 V J = 20 V K = 25 V M = 35 V N = 50 V	B = Gold Plated C = Hot solder dipped H = Solder Plated K = Solder fused	First two digits represent significant figures. Third digit specifies number of zeros.	J = ±5% K = ±10% M = ±20%	Weibull A = non-ER B = (0.1%/1,000 hours) C = (0.01%/1,000 hours) D = (0.001%/1,000 hours) T = T Level* (0.01%/1,000 hours) Exponential M = (1.0%/1,000 hours) P = (0.1%/1,000 hours) R = (0.01%/1,000 hours) S = (0.001%/1,000 hours)	A = +25°C after Weibull B = -55°C +85°C after Weibull C = -55°C +85°C before Weibull Z = None

* When T Level is ordered, no Surge Current Option is needed

Performance Characteristics

Item	Performance Characteristics
Operating Temperature	-55°C to 125°C
Rated Capacitance Range	0.1 – 100 µF @ 120 Hz/25°C
Capacitance Tolerance	J Tolerance (5%), K Tolerance (10%), M Tolerance (20%)
Rated Voltage Range	4 – 50 V
DF (120 Hz)	Refer to Part Number Electrical Specification Table
ESR (100 kHz)	Refer to Part Number Electrical Specification Table
Leakage Current	≤ 0.01 CV (µA) at rated voltage after 5 minutes

Qualification

Test	Condition	Characteristics					
Endurance	85°C @ rated voltage, 2,000 hours 125°C @ 2/3 rated voltage, 2,000 hours	Δ C/C	Within ±10% of initial value				
		DF	Within initial limits				
		DCL	Within 1.25 x initial limit				
		ESR	Within initial limits				
Storage Life	125°C @ 0 volts, 2,000 hours	Δ C/C	Within ±10% of initial value				
		DF	Within initial limits				
		DCL	Within 1.25 x initial limit				
		ESR	Within initial limits				
Thermal Shock	MIL–STD–202, Method 107, Condition B, mounted, -55°C to 125°C, 1,000 cycles	Δ C/C	Within ±5% of initial value				
		DF	Within initial limits				
		DCL	Within 1.25 x initial limit				
		ESR	Within initial limits				
Temperature Stability	Extreme temperature exposure at a succession of continuous steps at +25°C, -55°C, +25°C, +85°C, +125°C, +25°C	+25°C	-55°C	+85°C	+125°C		
		Δ C/C	IL*	±10%	±10%	±20%	
		DF	IL	IL	1.5 x IL	1.5 x IL	
		DCL	IL	n/a	10 x IL	12 x IL	
		Surge Voltage	25°C and 85°C, 1.32 x rated voltage 1,000 cycles (125°C, 1.2 x rated voltage)	Δ C/C	Within ±5% of initial value		
				DF	Within initial limits		
DCL	Within initial limits						
ESR	Within initial limits						
Mechanical Shock/Vibration	MIL–STD–202, Method 213, Condition I, 100 G peak MIL–STD–202, Method 204, Condition D, 10 Hz to 2,000 Hz, 20 G peak	Δ C/C	Within ±10% of initial value				
		DF	Within initial limits				
		DCL	Within initial limits				
Additional qualification tests per MIL–PRF–55365/8	Please contact KEMET for more information.						

*IL = Initial Limit

Certification

MIL–PRF–55365/8

Electrical Characteristics

ESR vs. Frequency

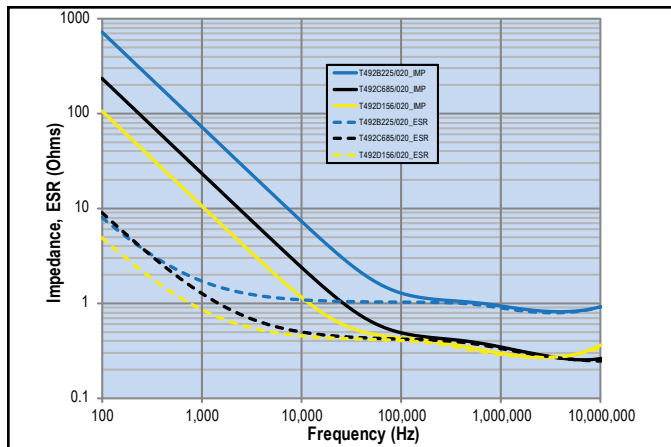

Capacitance vs. Frequency

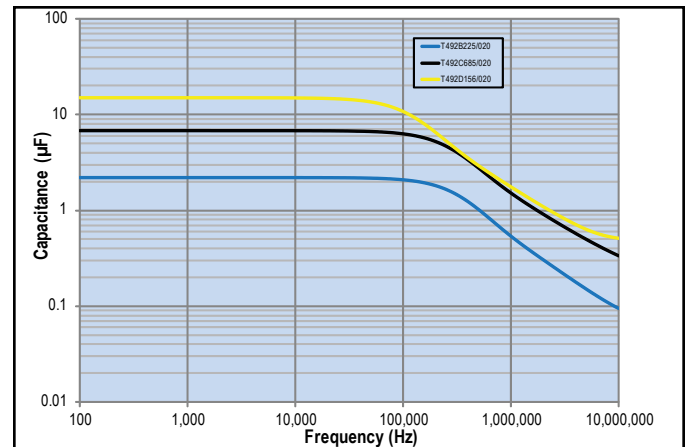

Dimensions – Millimeters (Inches)

Metric will govern

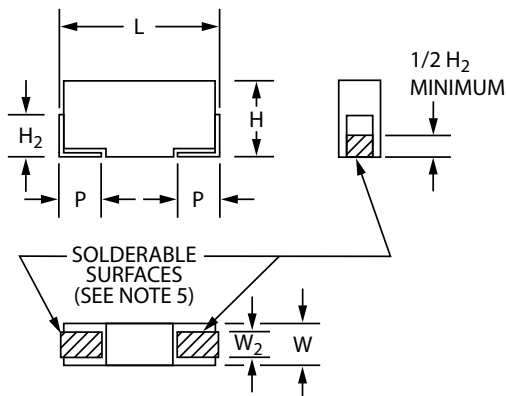

Case Size	Component					
KEMET	H*	H ₂ Minimum	L	P +/- 0.3 (0.012)	W	W ₂ +/- 0.1 (0.004)
A	1.6 ± 0.2 (0.063 ± 0.008)	0.7 (0.028)	3.2 ± 0.2 (0.126 ± 0.008)	0.8 (0.031)	1.6 ± 0.2 (0.063 ± 0.008)	1.2 (0.047)
B	1.9 ± 0.2 (0.075 ± 0.008)	0.7 (0.028)	3.5 ± 0.2 (0.138 ± 0.008)	0.8 (0.031)	2.8 ± 0.2 (0.110 ± 0.008)	2.2 (0.087)
C	2.5 ± 0.3 (0.098 ± 0.012)	1.0 (0.039)	6.0 ± 0.3 (0.236 ± 0.03)	1.3 (0.051)	3.2 ± 0.3 (0.126 ± 0.012)	2.2 (0.087)
D	2.8 ± 0.3 (0.110 ± 0.012)	1.0 (0.039)	7.3 ± 0.3 (0.287 ± 0.012)	1.3 (0.051)	4.3 ± 0.3 (0.169 ± 0.012)	2.4 (0.094)

Note: When solder coated terminations are required, add an additional 0.38 mm (0.015 inch) to the above tolerances for "L", "W", "H", "P", "W₂" and "H₂"

Table 1 – Ratings & Part Number Reference

Rated Voltage	Rated Cap	Case Code/ Case Size	KEMET Part Number	MIL–PRF–55365/8 Part Number	DC Leakage	DF	ESR	Moisture Sensitivity
VDC	µF	KEMET/EIA	(See below for part options)	(See below for part options)	µA @ +20°C Max/5 Min	% @ +20°C 120 Hz Max	Ω @ +20°C 100 kHz Max	Reflow Temperature ≤ 260°C
4	2.2	A/3216-18	T492A225(1)004(2)(3)(4)	CWR11C(6)225(1)(2)(5)	0.5	6.0	8.0	1
4	4.7	A/3216-18	T492A475(1)004(2)(3)(4)	CWR11C(6)475(1)(2)(5)	0.5	6.0	8.0	1
4	6.8	B/3528-21	T492B685(1)004(2)(3)(4)	CWR11C(6)685(1)(2)(5)	0.5	6.0	5.5	1
4	10	B/3528-21	T492B106(1)004(2)(3)(4)	CWR11C(6)106(1)(2)(5)	0.5	6.0	4.0	1
4	15	B/3528-21	T492B156(1)004(2)(3)(4)	CWR11C(6)156(1)(2)(5)	0.6	6.0	3.5	1
4	33	C/6032-28	T492C336(1)004(2)(3)(4)	CWR11C(6)336(1)(2)(5)	1.3	6.0	2.2	1
4	68	D/7343-31	T492D686(1)004(2)(3)(4)	CWR11C(6)686(1)(2)(5)	2.7	6.0	1.1	1
4	100	D/7343-31	T492D107(1)004(2)(3)(4)	CWR11C(6)107(1)(2)(5)	4.0	8.0	0.9	1
6	1.5	A/3216-18	T492A155(1)006(2)(3)(4)	CWR11D(6)155(1)(2)(5)	0.5	6.0	8.0	1
6	2.2	A/3216-18	T492A225(1)006(2)(3)(4)	CWR11D(6)225(1)(2)(5)	0.5	6.0	8.0	1
6	3.3	A/3216-18	T492A335(1)006(2)(3)(4)	CWR11D(6)335(1)(2)(5)	0.5	6.0	8.0	1
6	4.7	B/3528-21	T492B475(1)006(2)(3)(4)	CWR11D(6)475(1)(2)(5)	0.5	6.0	5.5	1
6	6.8	B/3528-21	T492B685(1)006(2)(3)(4)	CWR11D(6)685(1)(2)(5)	0.5	6.0	4.5	1
6	10	B/3528-21	T492B106(1)006(2)(3)(4)	CWR11D(6)106(1)(2)(5)	0.6	6.0	3.5	1
6	15	C/6032-28	T492C156(1)006(2)(3)(4)	CWR11D(6)156(1)(2)(5)	0.9	6.0	3.0	1
6	22	C/6032-28	T492C226(1)006(2)(3)(4)	CWR11D(6)226(1)(2)(5)	1.3	6.0	2.2	1
6	47	D/7343-31	T492D476(1)006(2)(3)(4)	CWR11D(6)476(1)(2)(5)	2.8	6.0	1.1	1
6	68	D/7343-31	T492D686(1)006(2)(3)(4)	CWR11D(6)686(1)(2)(5)	4.1	6.0	0.9	1
10	1	A/3216-18	T492A105(1)010(2)(3)(4)	CWR11F(6)105(1)(2)(5)	0.5	4.0	10.0	1
10	1.5	A/3216-18	T492A155(1)010(2)(3)(4)	CWR11F(6)155(1)(2)(5)	0.5	6.0	8.0	1
10	2.2	A/3216-18	T492A225(1)010(2)(3)(4)	CWR11F(6)225(1)(2)(5)	0.5	6.0	8.0	1
10	3.3	B/3528-21	T492B335(1)010(2)(3)(4)	CWR11F(6)335(1)(2)(5)	0.5	6.0	5.5	1
10	4.7	B/3528-21	T492B475(1)010(2)(3)(4)	CWR11F(6)475(1)(2)(5)	0.5	6.0	4.5	1
10	6.8	B/3528-21	T492B685(1)010(2)(3)(4)	CWR11F(6)685(1)(2)(5)	0.7	6.0	3.5	1
10	15	C/6032-28	T492C156(1)010(2)(3)(4)	CWR11F(6)156(1)(2)(5)	1.5	6.0	2.5	1
10	33	D/7343-31	T492D336(1)010(2)(3)(4)	CWR11F(6)336(1)(2)(5)	3.3	6.0	1.1	1
10	47	D/7343-31	T492D476(1)010(2)(3)(4)	CWR11F(6)476(1)(2)(5)	4.7	6.0	0.9	1
15	0.68	A/3216-18	T492A684(1)015(2)(3)(4)	CWR11H(6)684(1)(2)(5)	0.5	4.0	12.0	1
15	1	A/3216-18	T492A105(1)015(2)(3)(4)	CWR11H(6)105(1)(2)(5)	0.5	4.0	10.0	1
15	1.5	A/3216-18	T492A155(1)015(2)(3)(4)	CWR11H(6)155(1)(2)(5)	0.5	6.0	8.0	1
15	2.2	B/3528-21	T492B225(1)015(2)(3)(4)	CWR11H(6)225(1)(2)(5)	0.5	6.0	5.5	1
15	3.3	B/3528-21	T492B335(1)015(2)(3)(4)	CWR11H(6)335(1)(2)(5)	0.5	6.0	5.0	1
15	4.7	B/3528-21	T492B475(1)015(2)(3)(4)	CWR11H(6)475(1)(2)(5)	0.7	6.0	4.0	1
15	10	C/6032-28	T492C106(1)015(2)(3)(4)	CWR11H(6)106(1)(2)(5)	1.5	6.0	2.5	1
15	22	D/7343-31	T492D226(1)015(2)(3)(4)	CWR11H(6)226(1)(2)(5)	3.3	6.0	1.1	1
15	33	D/7343-31	T492D336(1)015(2)(3)(4)	CWR11H(6)336(1)(2)(5)	5.0	6.0	0.9	1
20	0.47	A/3216-18	T492A474(1)020(2)(3)(4)	CWR11J(6)474(1)(2)(5)	0.5	4.0	14.0	1
20	0.68	A/3216-18	T492A684(1)020(2)(3)(4)	CWR11J(6)684(1)(2)(5)	0.5	4.0	12.0	1
20	1	A/3216-18	T492A105(1)020(2)(3)(4)	CWR11J(6)105(1)(2)(5)	0.5	4.0	10.0	1
20	1.5	B/3528-21	T492B155(1)020(2)(3)(4)	CWR11J(6)155(1)(2)(5)	0.5	6.0	6.0	1
20	2.2	B/3528-21	T492B225(1)020(2)(3)(4)	CWR11J(6)225(1)(2)(5)	0.5	6.0	5.0	1
20	3.3	B/3528-21	T492B335(1)020(2)(3)(4)	CWR11J(6)335(1)(2)(5)	0.7	6.0	4.0	1
20	4.7	C/6032-28	T492C475(1)020(2)(3)(4)	CWR11J(6)475(1)(2)(5)	0.9	6.0	3.0	1
20	6.8	C/6032-28	T492C685(1)020(2)(3)(4)	CWR11J(6)685(1)(2)(5)	1.4	6.0	2.4	1
20	15	D/7343-31	T492D156(1)020(2)(3)(4)	CWR11J(6)156(1)(2)(5)	3.0	6.0	1.1	1
20	22	D/7343-31	T492D226(1)020(2)(3)(4)	CWR11J(6)226(1)(2)(5)	4.4	6.0	0.9	1
VDC	µF	KEMET/EIA	(See below for part options)	(See below for part options)	µA @ +20°C Max/5 Min	% @ +20°C 120 Hz Max	Ω @ +20°C 100 kHz Max	Reflow Temperature ≤ 260°C
Rated Voltage	Rated Cap	Case Code/ Case Size	KEMET Part Number	MIL–PRF–55365/8 Part Number	DC Leakage	DF	ESR	Moisture Sensitivity

Other part number options:

(1) To complete KEMET/CWR part number, insert M for ±20%, K for ±10%, or J for ±5%. Designates Capacitance tolerance.

(2) To complete KEMET/CWR part number, insert B (0.1%/1,000 Hours), C (0.01%/1,000 Hours), D (0.001%/1,000 Hours) or A = N/A. Designates Reliability Level.

(3) To complete KEMET part number, insert B = Gold Plated, C = Hot solder dipped, H or S = Solder Plated or K = Solder Fused. Designates Termination Finish.

(4) To complete KEMET part number, insert 4250 = +25°C after Weibull, 4251 = -55°C +85°C after Weibull, or 4252 = -55°C +85°C before Weibull. Designates Surge current option.

(5) To complete CWR part number, insert A = +25°C after Weibull, B = -55°C +85°C after Weibull, C = -55°C +85°C before Weibull or Z = None. Designates Surge current option.

(6) To complete CWR part number, insert B = Gold Plated, C = Hot Solder Dipped, H = Solder Plated or K = Solder Fused. Designates Termination Finish.

Refer to Ordering Information for additional detail.

Table 1 – Ratings & Part Number Reference cont'd

Rated Voltage	Rated Cap	Case Code/ Case Size	KEMET Part Number	MIL-PRF-55365/8 Part Number	DC Leakage	DF	ESR	Moisture Sensitivity
VDC	µF	KEMET/EIA	(See below for part options)	(See below for part options)	µA @ +20°C Max/5 Min	% @ +20°C 120 Hz Max	Ω @ +20°C 100 kHz Max	Reflow Temperature ≤ 260°C
25	0.68	B/3528-21	T492B684(1)025(2)(3)(4)	CWR11K(6)684(1)(2)(5)	0.5	4.0	7.5	1
25	1	B/3528-21	T492B105(1)025(2)(3)(4)	CWR11K(6)105(1)(2)(5)	0.5	4.0	6.5	1
25	1.5	B/3528-21	T492B155(1)025(2)(3)(4)	CWR11K(6)155(1)(2)(5)	0.5	6.0	6.5	1
25	2.2	C/6032-28	T492C225(1)025(2)(3)(4)	CWR11K(6)225(1)(2)(5)	0.6	6.0	3.5	1
25	3.3	C/6032-28	T492C335(1)025(2)(3)(4)	CWR11K(6)335(1)(2)(5)	0.8	6.0	3.5	1
25	4.7	C/6032-28	T492C475(1)025(2)(3)(4)	CWR11K(6)475(1)(2)(5)	1.2	6.0	2.5	1
25	6.8	D/7343-31	T492D685(1)025(2)(3)(4)	CWR11K(6)685(1)(2)(5)	1.7	6.0	1.4	1
25	10	D/7343-31	T492D106(1)025(2)(3)(4)	CWR11K(6)106(1)(2)(5)	2.5	6.0	1.2	1
25	15	D/7343-31	T492D156(1)025(2)(3)(4)	CWR11K(6)156(1)(2)(5)	3.8	6.0	1.0	1
35	0.1	A/3216-18	T492A104(1)035(2)(3)(4)	CWR11M(6)104(1)(2)(5)	0.5	4.0	24.0	1
35	0.15	A/3216-18	T492A154(1)035(2)(3)(4)	CWR11M(6)154(1)(2)(5)	0.5	4.0	21.0	1
35	0.22	A/3216-18	T492A224(1)035(2)(3)(4)	CWR11M(6)224(1)(2)(5)	0.5	4.0	18.0	1
35	0.33	A/3216-18	T492A334(1)035(2)(3)(4)	CWR11M(6)334(1)(2)(5)	0.5	4.0	15.0	1
35	0.47	B/3528-21	T492B474(1)035(2)(3)(4)	CWR11M(6)474(1)(2)(5)	0.5	4.0	10.0	1
35	0.68	B/3528-21	T492B684(1)035(2)(3)(4)	CWR11M(6)684(1)(2)(5)	0.5	4.0	8.0	1
35	1	B/3528-21	T492B105(1)035(2)(3)(4)	CWR11M(6)105(1)(2)(5)	0.5	4.0	6.5	1
35	1.5	C/6032-28	T492C155(1)035(2)(3)(4)	CWR11M(6)155(1)(2)(5)	0.5	6.0	4.5	1
35	2.2	C/6032-28	T492C225(1)035(2)(3)(4)	CWR11M(6)225(1)(2)(5)	0.8	6.0	3.5	1
35	3.3	C/6032-28	T492C335(1)035(2)(3)(4)	CWR11M(6)335(1)(2)(5)	1.2	6.0	2.5	1
35	4.7	D/7343-31	T492D475(1)035(2)(3)(4)	CWR11M(6)475(1)(2)(5)	1.6	6.0	1.5	1
35	6.8	D/7343-31	T492D685(1)035(2)(3)(4)	CWR11M(6)685(1)(2)(5)	2.4	6.0	1.3	1
50	0.1	A/3216-18	T492A104(1)050(2)(3)(4)	CWR11N(6)104(1)(2)(5)	0.5	6.0	22.0	1
50	0.15	B/3528-21	T492B154(1)050(2)(3)(4)	CWR11N(6)154(1)(2)(5)	0.5	4.0	17.0	1
50	0.22	B/3528-21	T492B224(1)050(2)(3)(4)	CWR11N(6)224(1)(2)(5)	0.5	4.0	14.0	1
50	0.33	B/3528-21	T492B334(1)050(2)(3)(4)	CWR11N(6)334(1)(2)(5)	0.5	4.0	12.0	1
50	0.47	C/6032-28	T492C474(1)050(2)(3)(4)	CWR11N(6)474(1)(2)(5)	0.5	4.0	8.0	1
50	0.68	C/6032-28	T492C684(1)050(2)(3)(4)	CWR11N(6)684(1)(2)(5)	0.5	4.0	7.0	1
50	1	C/6032-28	T492C105(1)050(2)(3)(4)	CWR11N(6)105(1)(2)(5)	0.5	4.0	6.0	1
50	1.5	D/7343-31	T492D155(1)050(2)(3)(4)	CWR11N(6)155(1)(2)(5)	0.8	6.0	4.0	1
50	2.2	D/7343-31	T492D225(1)050(2)(3)(4)	CWR11N(6)225(1)(2)(5)	1.1	6.0	2.5	1
50	3.3	D/7343-31	T492D335(1)050(2)(3)(4)	CWR11N(6)335(1)(2)(5)	1.7	6.0	2.0	1
50	4.7	D/7343-31	T492D475(1)050(2)(3)(4)	CWR11N(6)475(1)(2)(5)	2.4	6.0	1.5	1
VDC	µF	KEMET/EIA	(See below for part options)	(See below for part options)	µA @ +20°C Max/5 Min	% @ +20°C 120 Hz Max	Ω @ +20°C 100 kHz Max	Reflow Temperature ≤ 260°C
Rated Voltage	Rated Cap	Case Code/ Case Size	KEMET Part Number	MIL-PRF-55365/8 Part Number	DC Leakage	DF	ESR	Moisture Sensitivity

(1) To complete KEMET/CWR part number, insert M for ±20%, K for ±10%, or J for ±5%. Designates Capacitance tolerance.

Other part number options:

(1) To complete KEMET/CWR part number, insert M for ±20%, K for ±10%, or J for ±5%. Designates Capacitance tolerance.

(2) To complete KEMET/CWR part number, insert B (0.1%/1,000 Hours), C (0.01%/1,000 Hours), D (0.001%/1,000 Hours) or A = N/A. Designates Reliability Level.

(3) To complete KEMET part number, insert B = Gold Plated, C = Hot solder dipped, H or S = Solder Plated or K = Solder Fused. Designates Termination Finish.

(4) To complete KEMET part number, insert 4250 = +25°C after Weibull, 4251 = -55°C +85°C after Weibull, or 4252 = -55°C +85°C before Weibull. Designates Surge current option.

(5) To complete CWR part number, insert A = +25°C after Weibull, B = -55°C +85°C after Weibull, C = -55°C +85°C before Weibull or Z = None. Designates Surge current option.

(6) To complete CWR part number, insert B = Gold Plated, C = Hot Solder Dipped, H = Solder Plated or K = Solder Fused. Designates Termination Finish.

Refer to Ordering Information for additional detail.

Recommended Voltage Derating Guidelines

	-55°C to 85°C	85°C to 125°C
% Change in Working DC Voltage with Temperature	V_R	67% of V_R
Recommended Maximum Application Voltage	50% of V_R	33% of V_R

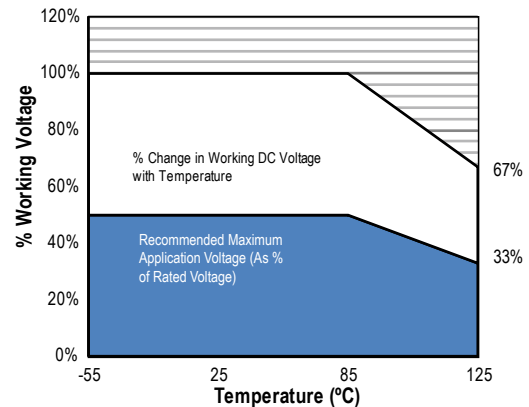

Ripple Current/Ripple Voltage

Permissible AC ripple voltage and current are related to equivalent series resistance (ESR) and the power dissipation capabilities of the device. Permissible AC ripple voltage which may be applied is limited by two criteria:

1. The positive peak AC voltage plus the DC bias voltage, if any, must not exceed the DC voltage rating of the capacitor.
2. The negative peak AC voltage in combination with bias voltage, if any, must not exceed the allowable limits specified for reverse voltage. See the Reverse Voltage section for allowable limits.

The maximum power dissipation by case size can be determined using the table at right. The maximum power dissipation rating stated in the table must be reduced with increasing environmental operating temperatures. Refer to the table below for temperature compensation requirements.

KEMET Case Code	EIA Case Code	Maximum Power Dissipation (P max) mWatts @ 25°C w/+20°C Rise
A	3216–18	75
B	3528–21	85
C	6032–28	110
D	7343–31	150
X	7343–43	165
E	7360–38	200
S	3216–12	60
T	3528–12	70
U	6032–15	90
V	7343–20	125
T510X	7343–43	270
T510E	7360–38	285

The maximum power dissipation rating must be reduced with increasing environmental operating temperatures. Refer to the Temperature Compensation Multiplier table for details.

Temperature Compensation Multipliers for Maximum Power Dissipation		
T ≤ 25°C	T ≤ 85°C	T ≤ 125°C
1.00	0.90	0.40

T = Environmental Temperature

Using the P max of the device, the maximum allowable rms ripple current or voltage may be determined.

$$I(max) = \sqrt{P_{max}/R}$$

$$E(max) = Z \sqrt{P_{max}/R}$$

I = rms ripple current (amperes)

E = rms ripple voltage (volts)

P max = maximum power dissipation (watts)

R = ESR at specified frequency (ohms)

Z = Impedance at specified frequency (ohms)

Reverse Voltage

Solid tantalum capacitors are polar devices and may be permanently damaged or destroyed if connected with the wrong polarity. The positive terminal is identified on the capacitor body by a stripe plus in some cases a beveled edge. A small degree of transient reverse voltage is permissible for short periods per the table. The capacitors should not be operated continuously in reverse mode, even within these limits.

Temperature	Permissible Transient Reverse Voltage
25°C	15% of Rated Voltage
85°C	5% of Rated Voltage
125°C	1% of Rated Voltage

Table 2 – Land Dimensions/Courtyard

KEMET	Metric Size Code	Density Level A: Maximum (Most) Land Protrusion (mm)					Density Level B: Median (Nominal) Land Protrusion (mm)					Density Level C: Minimum (Least) Land Protrusion (mm)				
		Case	EIA	W	L	S	V1	V2	W	L	S	V1	V2	W	L	S
A	3216–18	1.35	2.20	0.62	6.02	2.80	1.23	1.80	0.82	4.92	2.30	1.13	1.42	0.98	4.06	2.04
B	3528–21	2.35	2.21	0.92	6.32	4.00	2.23	1.80	1.12	5.22	3.50	2.13	1.42	1.28	4.36	3.24
C	6032–25	2.35	2.77	2.37	8.92	4.50	2.23	2.37	2.57	7.82	4.00	2.13	1.99	2.73	6.96	3.74
D	7343–31	2.55	2.77	3.67	10.22	5.60	2.43	2.37	3.87	9.12	5.10	2.33	1.99	4.03	8.26	4.84
L	6032-19	2.35	2.77	2.37	8.92	4.50	2.23	2.37	2.57	7.82	4.00	2.13	1.99	2.73	6.96	3.74
M	3528-15	2.35	2.20	0.92	6.32	4.00	2.23	1.80	1.12	5.22	3.50	2.13	1.42	1.28	4.36	3.24
H	7360-20	4.25	2.77	3.67	10.22	7.30	4.13	2.37	3.87	9.12	6.80	4.03	1.99	4.03	8.26	6.54
E ¹	7360–38	4.25	2.77	3.67	10.22	7.30	4.13	2.37	3.87	9.12	6.80	4.03	1.99	4.03	8.26	6.54
Q	7343-12	2.55	2.77	3.67	10.22	5.60	2.43	2.37	3.87	9.12	5.10	2.33	1.99	4.03	8.26	4.84
R ²	2012-12	1.05	1.83	0.15	4.82	2.50	0.93	1.50	0.22	3.72	2.00	0.83	1.12	0.38	2.86	1.74
S ²	3216–12	1.35	2.20	0.62	6.02	2.80	1.23	1.80	0.82	4.92	2.30	1.13	1.42	0.98	4.06	2.04
T	3528–12	2.35	2.20	0.92	6.32	4.00	2.23	1.80	1.12	5.22	3.50	2.13	1.42	1.28	4.36	3.24
U	6032–15	2.35	2.77	2.37	8.92	4.50	2.23	2.37	2.57	7.82	4.00	2.13	1.99	2.73	6.96	3.74
V	7343–20	2.55	2.77	3.67	10.22	5.60	2.43	2.37	3.87	9.12	5.10	2.33	1.99	4.03	8.26	4.84
W	7343–15	2.55	2.77	3.67	10.22	5.60	2.43	2.37	3.87	9.12	5.10	2.33	1.99	4.03	8.26	4.84
X ¹	7343–43	2.55	2.77	3.67	10.22	5.60	2.43	2.37	3.87	9.12	5.10	2.33	1.99	4.03	8.26	4.84
Y ¹	7343–40	2.55	2.77	3.67	10.22	5.60	2.43	2.37	3.87	9.12	5.10	2.33	1.99	4.03	8.26	4.84

Density Level A: For low-density product applications. Recommended for wave solder applications and provides a wider process window for reflow solder processes.

Density Level B: For products with a moderate level of component density. Provides a robust solder attachment condition for reflow solder processes.

Density Level C: For high component density product applications. Before adapting the minimum land pattern variations the user should perform qualification testing based on the conditions outlined in IPC standard 7351 (IPC–7351).

¹ Height of these chips may create problems in wave soldering.

² Land pattern geometry is too small for silkscreen outline.

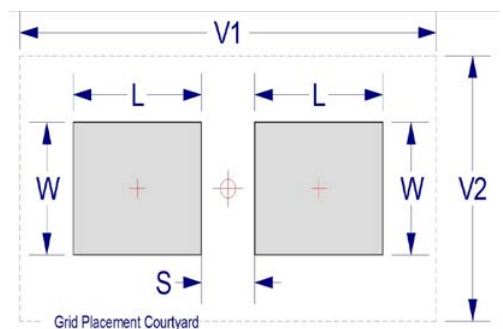

Soldering Process

KEMET’s families of surface mount capacitors are compatible with wave (single or dual), convection, IR or vapor phase reflow techniques. Preheating of these components is recommended to avoid extreme thermal stress. KEMET’s recommended profile conditions for convection and IR reflow reflect the profile conditions of the IPC/J–STD–020D standard for moisture sensitivity testing. The devices can safely withstand a maximum of three reflow passes at these conditions.

Note that although the X/7343–43 case size can withstand wave soldering, the tall profile (4.3 mm maximum) dictates care in wave process development.

Hand soldering should be performed with care due to the difficulty in process control. If performed, care should be taken to avoid contact of the soldering iron to the molded case. The iron should be used to heat the solder pad, applying solder between the pad and the termination, until reflow occurs. Once reflow occurred, the iron should be removed immediately. "Wiping" the edges of a chip and heating the top surface is not recommended.

During typical reflow operations, a slight darkening of the gold-colored epoxy may be observed. This slight darkening is normal and is not harmful to the product. Marking permanency is not affected by this change.

Profile Feature	SnPb Assembly	Pb-Free Assembly
Preheat/Soak		
Temperature Minimum (T_{Smin})	100°C	150°C
Temperature Maximum (T_{Smax})	150°C	200°C
Time (t_s) from T_{Smin} to T_{Smax}	60–120 seconds	60–120 seconds
Ramp-up Rate (T_L to T_P)	3°C/seconds maximum	3°C/seconds maximum
Liquidous Temperature (T_L)	183°C	217°C
Time Above Liquidous (t_L)	60–150 seconds	60–150 seconds
Peak Temperature (T_P)	220°C* 235°C**	250°C* 260°C**
Time within 5°C of Maximum Peak Temperature (t_p)	20 seconds maximum	30 seconds maximum
Ramp-down Rate (T_P to T_L)	6°C/seconds maximum	6°C/seconds maximum
Time 25°C to Peak Temperature	6 minutes maximum	8 minutes maximum

Note: All temperatures refer to the center of the package, measured on the package body surface that is facing up during assembly reflow.

*Case Size D, E, P, Y and X

**Case Size A, B, C, H, I, K, M, R, S, T, U, V, W and Z

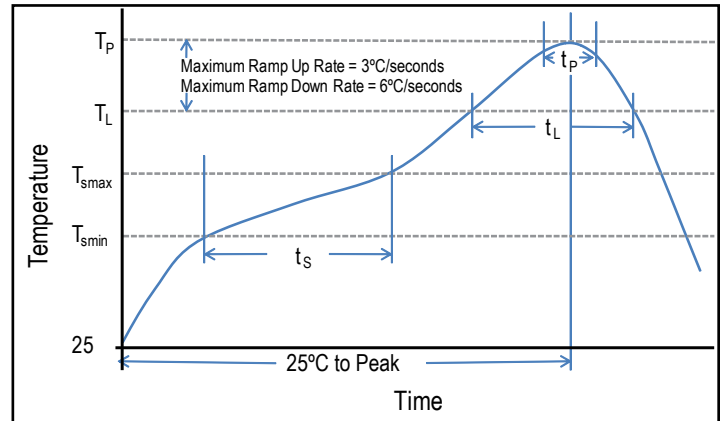

Construction

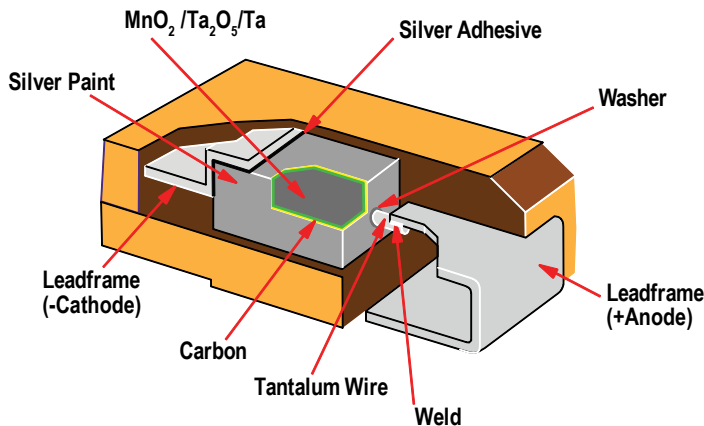

Capacitor Marking

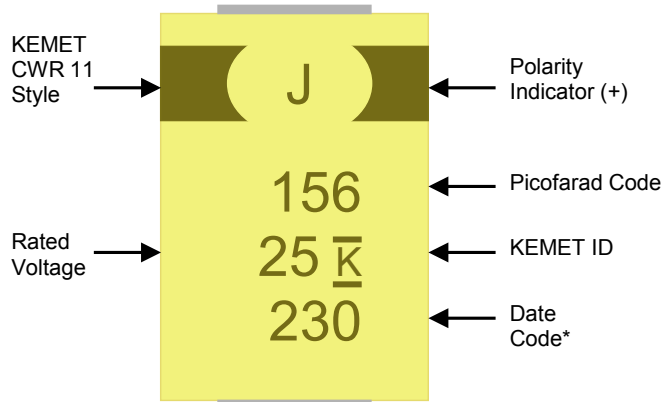

* 230 = 30th week of 2012

Date Code *	
1 st digit = Last number of Year	9 = 2009 0 = 2010 1 = 2011 2 = 2012 3 = 2013 4 = 2014
2 nd and 3 rd digit = Week of the Year	01 = 1 st week of the Year to 52 = 52 nd week of the Year

Storage

Tantalum chip capacitors should be stored in normal working environments. While the chips themselves are quite robust in other environments, solderability will be degraded by exposure to high temperatures, high humidity, corrosive atmospheres, and long term storage. In addition, packaging materials will be degraded by high temperature– reels may soften or warp and tape peel force may increase. KEMET recommends that maximum storage temperature not exceed 40°C and maximum storage humidity not exceed 60% relative humidity. Temperature fluctuations should be minimized to avoid condensation on the parts and atmospheres should be free of chlorine and sulphur bearing compounds. For optimized solderability chip stock should be used promptly, preferably within three years of receipt.

Tape & Reel Packaging Information

KEMET's molded tantalum and aluminum chip capacitor families are packaged in 8 and 12 mm plastic tape on 7" and 13" reels in accordance with *EIA Standard 481-1: Embossed Carrier Taping of Surface Mount Components for Automatic Handling*. This packaging system is compatible with all tape-fed automatic pick-and-place systems.

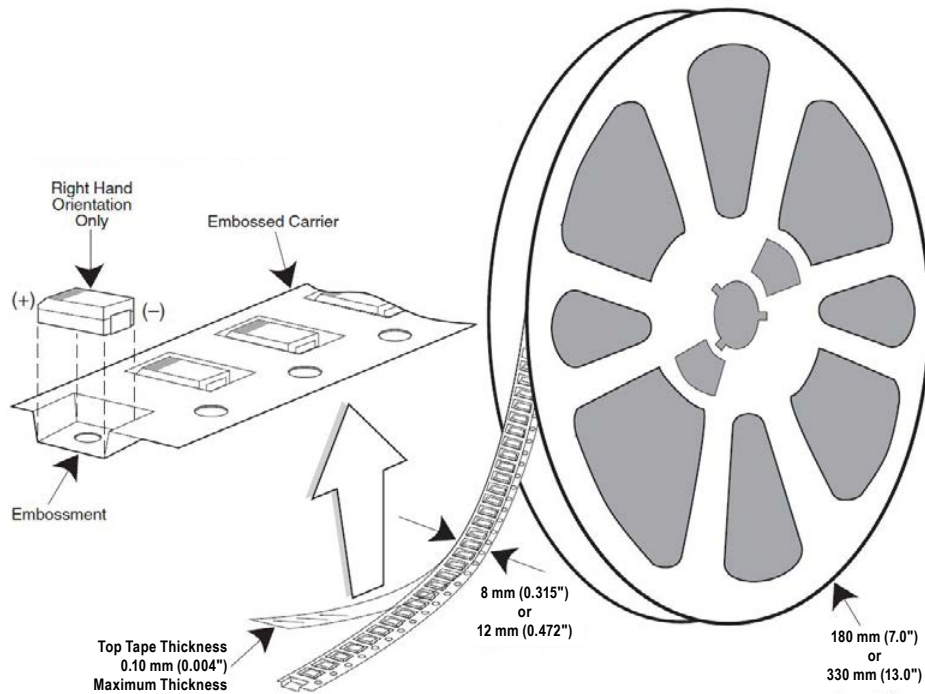

Table 3 – Packaging Quantity

KEMET Case Codes		Tape Width (mm)	Tape and Reel Dimensions	
			180 mm (7" diameter)	330 mm (13" diameter)
A	1005	8	2500	9500
B	1505	12	2500	9500
C	2005	12	2500	9500
D	1510	12	2500	9500
E	2010	12	2500	9500
F	2214	12	500	3500
G	2711	12	500	2500
H	2915	12	500	2500
X	2824	12	500	2500

Figure 1 – Embossed (Plastic) Carrier Tape Dimensions

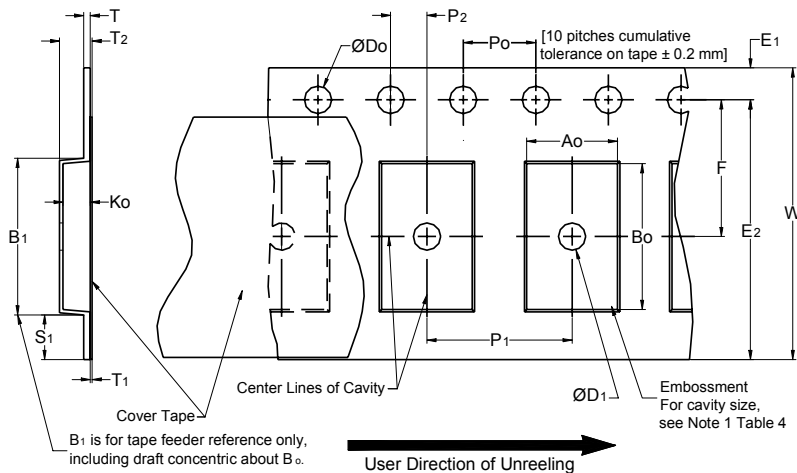

Table 4 – Embossed (Plastic) Carrier Tape Dimensions

Metric will govern

Constant Dimensions — Millimeters (Inches)									
Tape Size	D ₀	D ₁ Minimum Note 1	E ₁	P ₀	P ₂	R Reference Note 2	S ₁ Minimum Note 3	T Maximum	T ₁ Maximum
8 mm	1.5 +0.10/-0.0 (0.059 +0.004/-0.0)	1.0 (0.039)	1.75 ±0.10 (0.069 ±0.004)	4.0 ±0.10 (0.157 ±0.004)	2.0 ±0.05 (0.079 ±0.002)	25.0 (0.984)	0.600 (0.024)	0.600 (0.024)	0.100 (0.004)
12 mm		1.5 (0.059)				30 (1.181)			
16 mm									
Variable Dimensions — Millimeters (Inches)									
Tape Size	Pitch	B ₁ Maximum Note 4	E ₂ Minimum	F	P ₁	T ₂ Maximum	W Maximum	A ₀ , B ₀ & K ₀	
8 mm	Single (4 mm)	4.35 (0.171)	6.25 (0.246)	3.5 ±0.05 (0.138 ±0.002)	4.0 ±0.10 (0.157 ±0.004)	2.5 (0.098)	8.3 (0.327)	Note 5	
12 mm	Single (4 mm) & Double (8 mm)	8.2 (0.323)	10.25 (0.404)	5.5 ±0.05 (0.217 ±0.002)	8.0 ±0.10 (0.315 ±0.004)	4.6 (0.181)	12.3 (0.484)		
16 mm	Triple (12 mm)	12.1 (0.476)	14.25 (0.561)	5.5 ±0.05 (0.217 ±0.002)	8.0 ±0.10 (0.315 ±0.004)	4.6 (0.181)	16.3 (0.642)		

1. The embossment hole location shall be measured from the sprocket hole controlling the location of the embossment. Dimensions of embossment location and hole location shall be applied independent of each other.
2. The tape, with or without components, shall pass around R without damage (see Figure 5).
3. If S₁ < 1.0 mm, there may not be enough area for cover tape to be properly applied (see EIA Standard 481–D, paragraph 4.3, section b).
4. B₁ dimension is a reference dimension for tape feeder clearance only.
5. The cavity defined by A₀, B₀ and K₀ shall surround the component with sufficient clearance that:
 - (a) the component does not protrude above the top surface of the carrier tape.
 - (b) the component can be removed from the cavity in a vertical direction without mechanical restriction, after the top cover tape has been removed.
 - (c) rotation of the component is limited to 20° maximum for 8 and 12 mm tapes and 10° maximum for 16 mm tapes (see Figure 2).
 - (d) lateral movement of the component is restricted to 0.5 mm maximum for 8 mm and 12 mm wide tape and to 1.0 mm maximum for 16 mm tape (see Figure 3).
 - (e) see Addendum in EIA Standard 481–D for standards relating to more precise taping requirements.

Packaging Information Performance Notes

- 1. Cover Tape Break Force:** 1.0 Kg minimum.
- 2. Cover Tape Peel Strength:** The total peel strength of the cover tape from the carrier tape shall be:

Tape Width	Peel Strength
8 mm	0.1 to 1.0 Newton (10 to 100 gf)
12 and 16 mm	0.1 to 1.3 Newton (10 to 130 gf)

The direction of the pull shall be opposite the direction of the carrier tape travel. The pull angle of the carrier tape shall be 165° to 180° from the plane of the carrier tape. During peeling, the carrier and/or cover tape shall be pulled at a velocity of 300 ±10 mm/minute.

- 3. Labeling:** Bar code labeling (standard or custom) shall be on the side of the reel opposite the sprocket holes. Refer to EIA Standards 556 and 624.

Figure 2 – Maximum Component Rotation

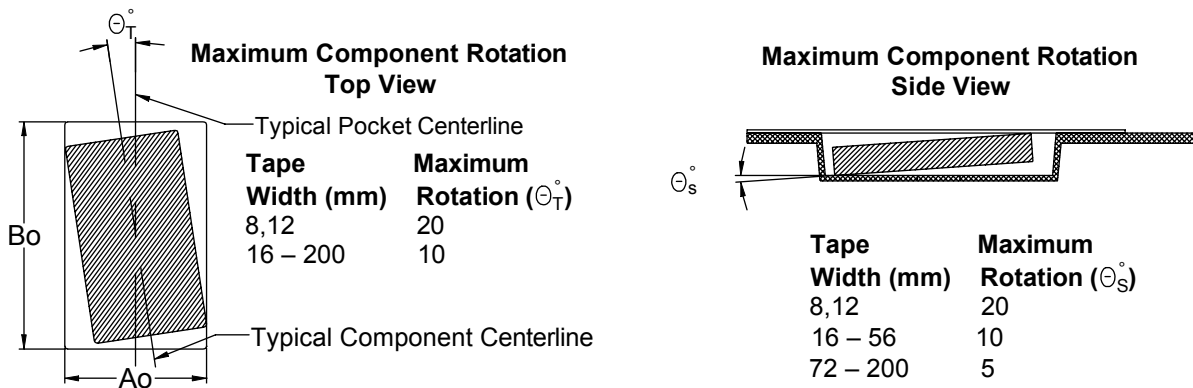

Figure 3 – Maximum Lateral Movement

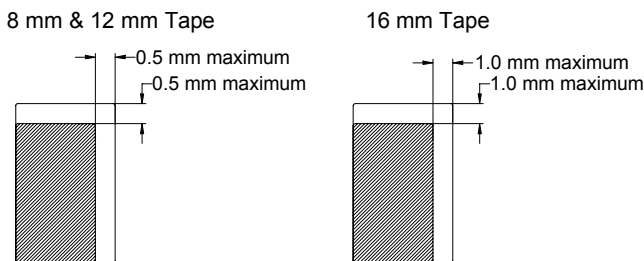

Figure 4 – Bending Radius

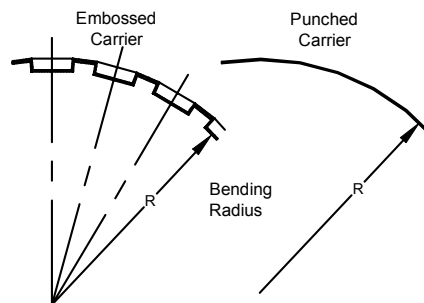

Figure 5 – Reel Dimensions

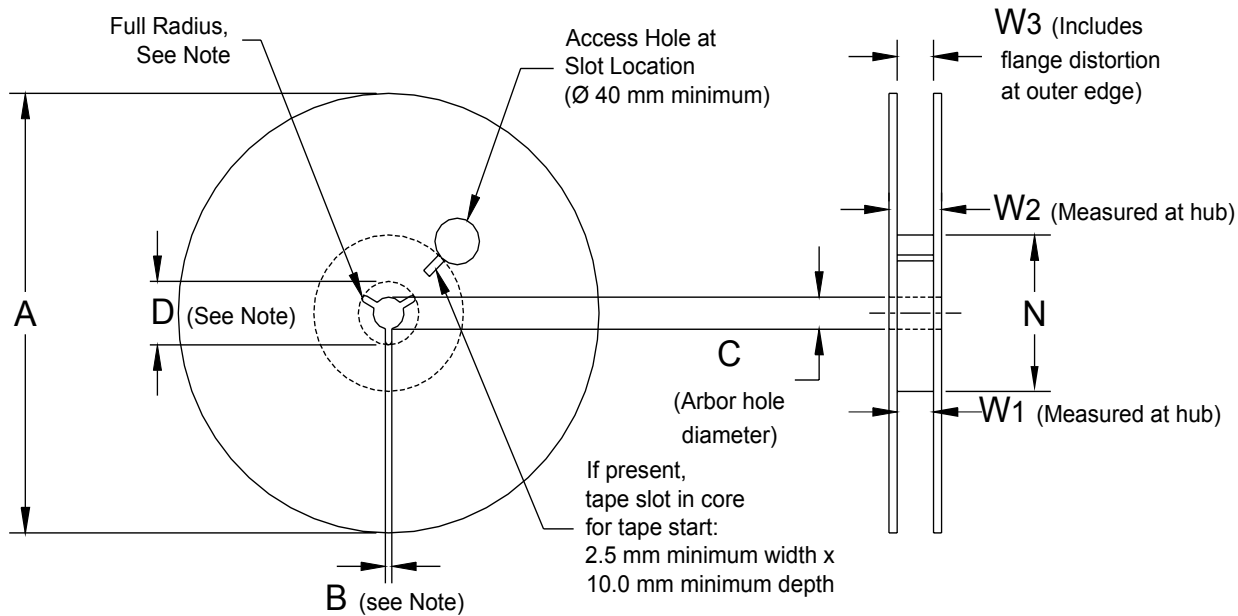

Table 5 – Reel Dimensions

Metric will govern

Constant Dimensions — Millimeters (Inches)				
Tape Size	A	B Minimum	C	D Minimum
8 mm	178 ±0.20 (7.008 ±0.008) or 330 ±0.20 (13.000 ±0.008)	1.5 (0.059)	13.0 +0.5/-0.2 (0.521 +0.02/-0.008)	20.2 (0.795)
12 mm				
16 mm				
Variable Dimensions — Millimeters (Inches)				
Tape Size	N Minimum	W1	W2 Maximum	W3
8 mm	50 (1.969)	8.4 +1.5/-0.0 (0.331 +0.059/-0.0)	14.4 (0.567)	Shall accommodate tape width without interference
12 mm		12.4 +2.0/-0.0 (0.488 +0.078/-0.0)	18.4 (0.724)	
16 mm		16.4 +2.0/-0.0 (0.646 +0.078/-0.0)	22.4 (0.882)	

Figure 6 – Tape Leader & Trailer Dimensions

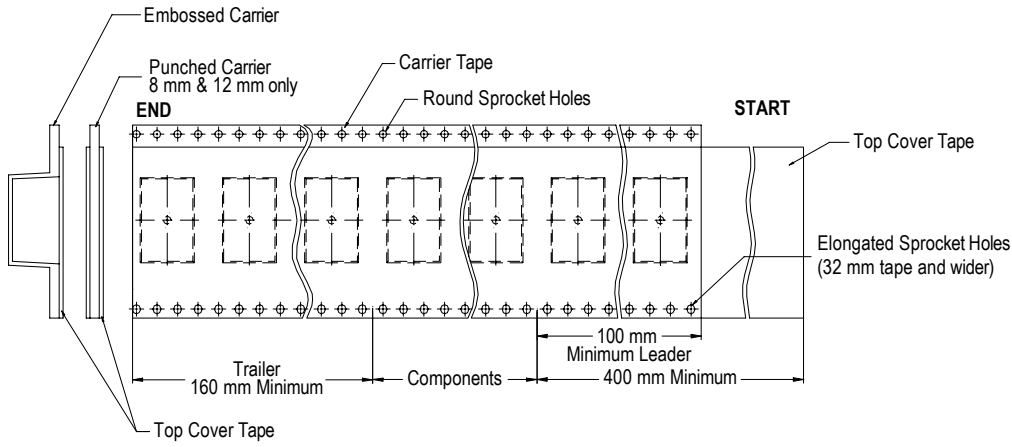
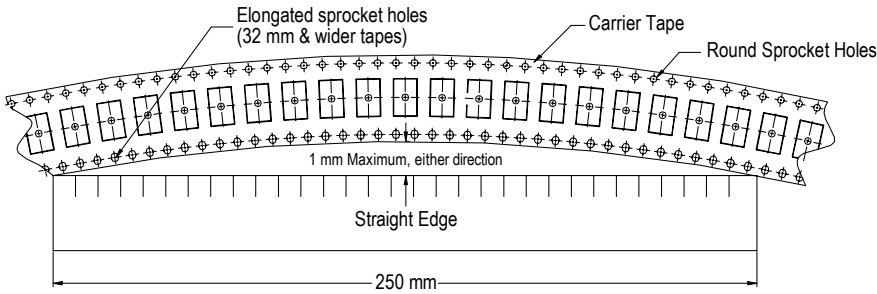

Figure 7 – Maximum Camber



KEMET Corporation World Headquarters

2835 KEMET Way
Simpsonville, SC 29681

Mailing Address:
P.O. Box 5928
Greenville, SC 29606

www.kemet.com
Tel: 864-963-6300
Fax: 864-963-6521

Corporate Offices
Fort Lauderdale, FL
Tel: 954-766-2800

North America

Southeast
Lake Mary, FL
Tel: 407-855-8886

Northeast
Wilmington, MA
Tel: 978-658-1663

Central
Novi, MI
Tel: 248-994-1030

West
Milpitas, CA
Tel: 408-433-9950

Mexico
Guadalajara, Jalisco
Tel: 52-33-3123-2141

Europe

Southern Europe
Paris, France
Tel: 33-1-4646-1006

Sasso Marconi, Italy
Tel: 39-051-939111

Central Europe
Landsberg, Germany
Tel: 49-8191-3350800

Kamen, Germany
Tel: 49-2307-438110

Northern Europe
Bishop's Stortford, United Kingdom
Tel: 44-1279-460122

Espoo, Finland
Tel: 358-9-5406-5000

Asia

Northeast Asia
Hong Kong
Tel: 852-2305-1168

Shenzhen, China
Tel: 86-755-2518-1306

Beijing, China
Tel: 86-10-5829-1711

Shanghai, China
Tel: 86-21-6447-0707

Taipei, Taiwan
Tel: 886-2-27528585

Southeast Asia
Singapore
Tel: 65-6586-1900

Penang, Malaysia
Tel: 60-4-6430200

Bangalore, India
Tel: 91-806-53-76817

Note: KEMET reserves the right to modify minor details of internal and external construction at any time in the interest of product improvement. KEMET does not assume any responsibility for infringement that might result from the use of KEMET Capacitors in potential circuit designs. KEMET is a registered trademark of KEMET Electronics Corporation.

Other KEMET Resources

Tools	
Resource	Location
Configure A Part: CapEdge	http://capacitoredge.kemet.com
SPICE & FIT Software	http://www.kemet.com/spice
Search Our FAQs: KnowledgeEdge	http://www.kemet.com/keask
Electrolytic LifeCalculator	http://www.kemet.com:8080/elc

Product Information	
Resource	Location
Products	http://www.kemet.com/products
Technical Resources (Including Soldering Techniques)	http://www.kemet.com/technicalpapers
RoHS Statement	http://www.kemet.com/rohs
Quality Documents	http://www.kemet.com/qualitydocuments

Product Request	
Resource	Location
Sample Request	http://www.kemet.com/sample
Engineering Kit Request	http://www.kemet.com/kits

Contact	
Resource	Location
Website	www.kemet.com
Contact Us	http://www.kemet.com/contact
Investor Relations	http://www.kemet.com/ir
Call Us	1-877-MyKEMET
Twitter	http://twitter.com/kemetcapacitors

Disclaimer

All product specifications, statements, information and data (collectively, the "Information") in this datasheet are subject to change. The customer is responsible for checking and verifying the extent to which the Information contained in this publication is applicable to an order at the time the order is placed.

All Information given herein is believed to be accurate and reliable, but it is presented without guarantee, warranty, or responsibility of any kind, expressed or implied.

Statements of suitability for certain applications are based on KEMET Electronics Corporation's ("KEMET") knowledge of typical operating conditions for such applications, but are not intended to constitute – and KEMET specifically disclaims – any warranty concerning suitability for a specific customer application or use. The Information is intended for use only by customers who have the requisite experience and capability to determine the correct products for their application. Any technical advice inferred from this Information or otherwise provided by KEMET with reference to the use of KEMET's products is given gratis, and KEMET assumes no obligation or liability for the advice given or results obtained.

Although KEMET designs and manufactures its products to the most stringent quality and safety standards, given the current state of the art, isolated component failures may still occur. Accordingly, customer applications which require a high degree of reliability or safety should employ suitable designs or other safeguards (such as installation of protective circuitry or redundancies) in order to ensure that the failure of an electrical component does not result in a risk of personal injury or property damage.

Although all product-related warnings, cautions and notes must be observed, the customer should not assume that all safety measures are indicated or that other measures may not be required.

Product & Process Design

Sales & Marketing

Supplier

Material Management

Quality

Manufacturing

Logistics & Distribution

People: Leadership
& Development

KEMET Production System

Corporate Offices

KEMET Corporation
2835 KEMET Way
Simpsonville, SC 29681
USA
Tel: 864.963.6300
Fax: 864.963.6521

KEMET Electronics GmbH
Rudolf-Diesel-Straße 21
86899 Landsberg
Germany
Tel: +49 8191 3350 ext. 0
Fax: 49 8191 335063

KEMET Electronics Marketing (S) Pte Ltd.
73 Bukit Timah Road
#05-01 Rex House
Singapore 229832
Tel: 65.6586.1900
Fax: 65.6586.1901

www.kemet.com

One world. One KEMET.

Electronic Components
KEMET
CHARGED®