



Workbenches and accessories

Workbenches from bott are robust and practical, ergonomic and flexible. A wide range of product variants gives you the freedom to configure solutions to your personal specification. Tailor-made workbenches are indispensable additions to any workshop.

An extensive line of accessories completes this product range.

Workbench WEL	62 – 63
Workbench WFT	64 – 65
Accessories for workbench WEL & WFT	66 – 67
Workbench BMN	68 – 71
Accessories for workbench BMN	72 – 73
Workbench WPB	74 – 75
Workbench WB	76 – 79
Group Workstations	80 – 81
Accessories for workbench WB and Group Workstations ..	82 – 83
Workbench WL	84 – 85
Accessories for workbench WL	86 – 87
Modular Workbenches KWB	88 – 97
Accessories for Modular Workbenches KWB	98 – 99
Worktops	100 – 104
Accessories & Parts for workbenches	105 – 108
Foldable Workbenches	109
Vices	110 – 111
Seating	112 – 113



Workbench WEL



Dimensions: Width 1500/2000 x Depth 700/900 x Height 830-850 mm

- Suitable for light assembly work
- Load capacity 200 kg
- Robust tubular steel framework
- Choose from 2 worktop finishes (Thickness 20 mm)
- Load capacity per drawer 75 kg
- Supplied flat packed for self assembly. We can offer a full assembly service, please contact us for details.
- Frame size: W 1434/1934 x D 694/894 x H 790 mm
- Drawer divider systems – see page 210-225



With CS series drawer cabinets – see page 12/13 for more details



Description	Dimensions W x D mm	Worktop	Part ref.	Price £
WELM 1570	1500 x 700	Multiplex	110 42 301.16	187.00
WELM 1590	1500 x 900	Multiplex	110 42 302.16	210.00
WELM 2070	2000 x 700	Multiplex	110 42 303.16	227.00
WELM 2090	2000 x 900	Multiplex	110 42 304.16	254.00
WELL 1570	1500 x 700	Linoleum	110 42 305.16	246.00
WELL 1590	1500 x 900	Linoleum	110 42 306.16	266.00
WELL 2070	2000 x 700	Linoleum	110 42 307.16	283.00
WELL 2090	2000 x 900	Linoleum	110 42 308.16	311.00



Description	Dimensions W x D mm	Worktop	Part ref.	Price £
WELM 1570 + CS 225-1	1500 x 700	Multiplex	110 08 161.03	327.00
WELM 1590 + CS 225-1	1500 x 900	Multiplex	110 08 167.03	350.00
WELM 2070 + CS 225-1	2000 x 700	Multiplex	110 08 173.03	367.00
WELM 2090 + CS 225-1	2000 x 900	Multiplex	110 08 179.03	394.00
WELL 1570 + CS 225-1	1500 x 700	Linoleum	110 08 185.03	386.00
WELL 1590 + CS 225-1	1500 x 900	Linoleum	110 08 191.03	406.00
WELL 2070 + CS 225-1	2000 x 700	Linoleum	110 08 197.03	423.00
WELL 2090 + CS 225-1	2000 x 900	Linoleum	110 08 203.03	451.00



Description	Dimensions W x D mm	Worktop	Part ref.	Price £
WELM 1570 + CS 425-3	1500 x 700	Multiplex	110 08 162.03	432.00
WELM 1590 + CS 425-3	1500 x 900	Multiplex	110 08 168.03	455.00
WELM 2070 + CS 425-3	2000 x 700	Multiplex	110 08 174.03	472.00
WELM 2090 + CS 425-3	2000 x 900	Multiplex	110 08 180.03	499.00
WELL 1570 + CS 425-3	1500 x 700	Linoleum	110 08 186.03	491.00
WELL 1590 + CS 425-3	1500 x 900	Linoleum	110 08 192.03	511.00
WELL 2070 + CS 425-3	2000 x 700	Linoleum	110 08 198.03	528.00
WELL 2090 + CS 425-3	2000 x 900	Linoleum	110 08 204.03	556.00



Description	Dimensions W x D mm	Worktop	Part ref.	Price £
WELM 1570 + CS 650-1	1500 x 700	Multiplex	110 08 163.03	371.00
WELM 1590 + CS 650-1	1500 x 900	Multiplex	110 08 169.03	394.00
WELM 2070 + CS 650-1	2000 x 700	Multiplex	110 08 175.03	411.00
WELM 2090 + CS 650-1	2000 x 900	Multiplex	110 08 181.03	438.00
WELL 1570 + CS 650-1	1500 x 700	Linoleum	110 08 187.03	430.00
WELL 1590 + CS 650-1	1500 x 900	Linoleum	110 08 193.03	450.00
WELL 2070 + CS 650-1	2000 x 700	Linoleum	110 08 199.03	467.00
WELL 2090 + CS 650-1	2000 x 900	Linoleum	110 08 205.03	495.00

Standard paint finish

Housing:	RAL 7035 light grey
Fronts:	RAL 5015 blue .03

Alternative front colours (no extra charge)

RAL 7035 light grey	RAL 7035 light grey	RAL 7035 light grey	RAL 7035 light grey	RAL 7035 light grey
RAL 7035 light grey .16	RAL 7001 grey .01	RAL 6011 green .02	RAL 3001 red .04	RAL 1023 yellow .12

(Please replace the order ref. suffix from .03 to that for your required colour)

Workbench WEL

Dimensions: Width 1500/2000 x Depth 700/900 x Height 830-850 mm



Description	Dimensions W x D mm	Worktop	Part ref.	Price £
WELM 1570 + CS 650-2	1500 x 700	Multiplex	110 08 164.03	413.00
WELM 1590 + CS 650-2	1500 x 900	Multiplex	110 08 170.03	436.00
WELM 2070 + CS 650-2	2000 x 700	Multiplex	110 08 176.03	453.00
WELM 2090 + CS 650-2	2000 x 900	Multiplex	110 08 182.03	480.00
WELL 1570 + CS 650-2	1500 x 700	Linoleum	110 08 188.03	472.00
WELL 1590 + CS 650-2	1500 x 900	Linoleum	110 08 194.03	492.00
WELL 2070 + CS 650-2	2000 x 700	Linoleum	110 08 200.03	509.00
WELL 2090 + CS 650-2	2000 x 900	Linoleum	110 08 206.03	537.00



Description	Dimensions W x D mm	Worktop	Part ref.	Price £
WELM 1570 + CS 650-3	1500 x 700	Multiplex	110 08 165.03	458.00
WELM 1590 + CS 650-3	1500 x 900	Multiplex	110 08 171.03	481.00
WELM 2070 + CS 650-3	2000 x 700	Multiplex	110 08 177.03	498.00
WELM 2090 + CS 650-3	2000 x 900	Multiplex	110 08 183.03	525.00
WELL 1570 + CS 650-3	1500 x 700	Linoleum	110 08 189.03	517.00
WELL 1590 + CS 650-3	1500 x 900	Linoleum	110 08 195.03	537.00
WELL 2070 + CS 650-3	2000 x 700	Linoleum	110 08 201.03	554.00
WELL 2090 + CS 650-3	2000 x 900	Linoleum	110 08 207.03	582.00



Description	Dimensions W x D mm	Worktop	Part ref.	Price £
WELM 1570 + CS 650-5	1500 x 700	Multiplex	110 08 166.03	556.00
WELM 1590 + CS 650-5	1500 x 900	Multiplex	110 08 172.03	579.00
WELM 2070 + CS 650-5	2000 x 700	Multiplex	110 08 178.03	596.00
WELM 2090 + CS 650-5	2000 x 900	Multiplex	110 08 184.03	623.00
WELL 1570 + CS 650-5	1500 x 700	Linoleum	110 08 190.03	615.00
WELL 1590 + CS 650-5	1500 x 900	Linoleum	110 08 196.03	635.00
WELL 2070 + CS 650-5	2000 x 700	Linoleum	110 08 202.03	652.00
WELL 2090 + CS 650-5	2000 x 900	Linoleum	110 08 208.03	680.00

Shelf for workbench WEL

Material: Chipboard core laminate faced



Description	for workbench with Width x Depth mm	Part ref.	Price £
Base shelf	1500 x 700	110 42 040	97.00
Base shelf	1500 x 900	110 42 041	130.00
Base shelf	2000 x 700	110 42 042	111.00
Base shelf	2000 x 900	110 42 043	145.00

Standard paint finish

Housing:	RAL 7035 light grey
Fronts:	RAL 5015 blue .03

Alternative front colours (no extra charge)

RAL 7035 light grey	RAL 7035 light grey	RAL 7035 light grey	RAL 7035 light grey	RAL 7035 light grey
RAL 7035 light grey .16	RAL 7001 grey .01	RAL 6011 green .02	RAL 3001 red .04	RAL 1023 yellow .12

(Please replace the order ref. suffix from .03 to that for your required colour)

Drawer
Cabinets

Workbenches

Workstation
Systems APS

Mobile
Equipment

Storage
Cupboards

Combination Drawer
& Shelving System

Drawer
Dividers

Perfo® System

CNC System

Cases

Workbench WFT

Dimensions: Width 1500/2000 x Depth 700/900 x Height 830-850 mm



- Suitable for light assembly work
- Load capacity 200 kg
- Tubular and sheet steel construction. Cantilever design for complete freedom of movement.
- Choose from 2 worktop finishes (Thickness 20 mm)
- Load capacity per drawer 75 kg
- Supplied flat packed for self assembly. We can offer a full assembly service, please contact us for details.
- Frame size: W 1420/1920 x D 694/894 x H 794 mm
- Drawer divider systems see page 210-225



With CS series drawer cabinets – see page 12/13 for more details



Description	Dimensions W x D mm	Worktop	Part ref.	Price £
WFTM 1570	1500 x 700	Multiplex	110 43 001.16	285.55
WFTM 1590	1500 x 900	Multiplex	110 43 002.16	310.35
WFTM 2070	2000 x 700	Multiplex	110 43 003.16	315.05
WFTM 2090	2000 x 900	Multiplex	110 43 004.16	344.63
WFTL 1570	1500 x 700	Linoleum	110 43 005.16	336.55
WFTL 1590	1500 x 900	Linoleum	110 43 006.16	376.39
WFTL 2070	2000 x 700	Linoleum	110 43 007.16	489.39
WFTL 2090	2000 x 900	Linoleum	110 43 008.16	420.02



Description	Dimensions W x D mm	Worktop	Part ref.	Price £
WFTM 1570 + CS 225-1	1500 x 700	Multiplex	110 08 209.03	422.55
WFTM 1590 + CS 225-1	1500 x 900	Multiplex	110 08 215.03	450.35
WFTM 2070 + CS 225-1	2000 x 700	Multiplex	110 08 221.03	455.05
WFTM 2090 + CS 225-1	2000 x 900	Multiplex	110 08 227.03	484.63
WFTL 1570 + CS 225-1	1500 x 700	Linoleum	110 08 233.03	476.56
WFTL 1590 + CS 225-1	1500 x 900	Linoleum	110 08 239.03	516.39
WFTL 2070 + CS 225-1	2000 x 700	Linoleum	110 08 245.03	629.39
WFTL 2090 + CS 225-1	2000 x 900	Linoleum	110 08 251.03	560.02



Description	Dimensions W x D mm	Worktop	Part ref.	Price £
WFTM 1570 + CS 425-3	1500 x 700	Multiplex	110 08 210.03	527.55
WFTM 1590 + CS 425-3	1500 x 900	Multiplex	110 08 216.03	555.35
WFTM 2070 + CS 425-3	2000 x 700	Multiplex	110 08 222.03	560.05
WFTM 2090 + CS 425-3	2000 x 900	Multiplex	110 08 228.03	589.63
WFTL 1570 + CS 425-3	1500 x 700	Linoleum	110 08 234.03	581.56
WFTL 1590 + CS 425-3	1500 x 900	Linoleum	110 08 240.03	621.39
WFTL 2070 + CS 425-3	2000 x 700	Linoleum	110 08 246.03	734.39
WFTL 2090 + CS 425-3	2000 x 900	Linoleum	110 08 252.03	665.02

Standard paint finish

Housing:	RAL 7035 light grey
Fronts:	RAL 5015 blue .03

Alternative front colours (no extra charge)

RAL 7035 light grey	RAL 7035 light grey	RAL 7035 light grey	RAL 7035 light grey	RAL 7035 light grey
RAL 7035 light grey .16	RAL 7001 grey .01	RAL 6011 green .02	RAL 3001 red .04	RAL 1023 yellow .12

(Please replace the order ref. suffix from .03 to that for your required colour)

Workbench WFT

Dimensions: Width 1500/2000 x Depth 700/900 x Height 830-850 mm



Description	Dimensions W x D mm	Worktop	Part ref.	Price £
WFTM 1570 + CS 650-1	1500 x 700	Multiplex	110 08 211.03	466.55
WFTM 1590 + CS 650-1	1500 x 900	Multiplex	110 08 217.03	494.35
WFTM 2070 + CS 650-1	2000 x 700	Multiplex	110 08 223.03	499.05
WFTM 2090 + CS 650-1	2000 x 900	Multiplex	110 08 229.03	528.63
WFTL 1570 + CS 650-1	1500 x 700	Linoleum	110 08 235.03	520.56
WFTL 1590 + CS 650-1	1500 x 900	Linoleum	110 08 241.03	560.39
WFTL 2070 + CS 650-1	2000 x 700	Linoleum	110 08 247.03	673.39
WFTL 2090 + CS 650-1	2000 x 900	Linoleum	110 08 253.03	604.02



Description	Dimensions W x D mm	Worktop	Part ref.	Price £
WFTM 1570 + CS 650-2	1500 x 700	Multiplex	110 08 212.03	508.55
WFTM 1590 + CS 650-2	1500 x 900	Multiplex	110 08 218.03	536.35
WFTM 2070 + CS 650-2	2000 x 700	Multiplex	110 08 224.03	541.05
WFTM 2090 + CS 650-2	2000 x 900	Multiplex	110 08 230.03	570.63
WFTL 1570 + CS 650-2	1500 x 700	Linoleum	110 08 236.03	562.56
WFTL 1590 + CS 650-2	1500 x 900	Linoleum	110 08 242.03	602.39
WFTL 2070 + CS 650-2	2000 x 700	Linoleum	110 08 248.03	715.39
WFTL 2090 + CS 650-2	2000 x 900	Linoleum	110 08 254.03	646.02



Description	Dimensions W x D mm	Worktop	Part ref.	Price £
WFTM 1570 + CS 650-3	1500 x 700	Multiplex	110 08 213.03	553.55
WFTM 1590 + CS 650-3	1500 x 900	Multiplex	110 08 219.03	581.35
WFTM 2070 + CS 650-3	2000 x 700	Multiplex	110 08 225.03	586.05
WFTM 2090 + CS 650-3	2000 x 900	Multiplex	110 08 231.03	615.63
WFTL 1570 + CS 650-3	1500 x 700	Linoleum	110 08 237.03	607.56
WFTL 1590 + CS 650-3	1500 x 900	Linoleum	110 08 243.03	647.39
WFTL 2070 + CS 650-3	2000 x 700	Linoleum	110 08 249.03	760.39
WFTL 2090 + CS 650-3	2000 x 900	Linoleum	110 08 255.03	691.02



Description	Dimensions W x D mm	Worktop	Part ref.	Price £
WFTM 1570 + CS 650-5	1500 x 700	Multiplex	110 08 214.03	651.55
WFTM 1590 + CS 650-5	1500 x 900	Multiplex	110 08 220.03	679.35
WFTM 2070 + CS 650-5	2000 x 700	Multiplex	110 08 226.03	684.05
WFTM 2090 + CS 650-5	2000 x 900	Multiplex	110 08 232.03	713.63
WFTL 1570 + CS 650-5	1500 x 700	Linoleum	110 08 238.03	705.56
WFTL 1590 + CS 650-5	1500 x 900	Linoleum	110 08 244.03	745.39
WFTL 2070 + CS 650-5	2000 x 700	Linoleum	110 08 250.03	858.39
WFTL 2090 + CS 650-5	2000 x 900	Linoleum	110 08 256.03	789.02

Standard paint finish

Housing:	RAL 7035 light grey
Fronts:	RAL 5015 blue .03

Alternative front colours (no extra charge)

RAL 7035 light grey	RAL 7035 light grey	RAL 7035 light grey	RAL 7035 light grey	RAL 7035 light grey
RAL 7035 light grey .16	RAL 7001 grey .01	RAL 6011 green .02	RAL 3001 red .04	RAL 1023 yellow .12

(Please replace the order ref. suffix from .03 to that for your required colour)

Drawer
Cabinets

Workbenches

Workstation
Systems APS

Mobile
Equipment

Storage
Cupboards

Combination Drawer
& Shelving System

Drawer
Dividers

Perfo® System

CNC System

Cases

Drawer Cabinets

Workbenches

Workstation Systems APS

Mobile Equipment

Storage Cupboards

Combination Drawer & Shelving System







Drawer Dividers

Perfo® System















CNC System

Cases



- A**  Overhead light and frame (UK or EU version)
- B**  Support brackets (2 piece) max. height 1200 mm
- C**  Power duct (UK or EU version) incl. 4 outlets
- D**  Perfo® perforated panel
- E**  Perfo® louvred panel
- F**  Perfo® combination panels
- G**  Metal shelf

Complete range consisting of:

	A	B	C	D	E	F	G	Part ref.	Price £
for workbench									
Width mm									
1500		•		•				070 02 147.03	67.00
1500		•			•			070 02 148.03	67.00
1500		•				•		070 02 149.03	67.00
2000		•		•				070 02 150.03	82.00
2000		•			•			070 02 151.03	82.00
2000		•				•		070 02 152.03	82.00
1500		•	UK	•				070 02 153.03	231.00
1500		•	UK		•			070 02 154.03	231.00
1500		•	UK			•		070 02 155.03	231.00
2000		•	UK	•				070 02 156.03	253.00
2000		•	UK		•			070 02 157.03	253.00
2000		•	UK			•		070 02 158.03	253.00
1500	EU / UK	•		•			•	070 02 159.03	253.00
1500	EU / UK	•			•		•	070 02 160.03	253.00
1500	EU / UK	•				•	•	070 02 161.03	253.00
2000	EU / UK	•		•			•	070 02 162.03	281.00
2000	EU / UK	•			•		•	070 02 163.03	281.00
2000	EU / UK	•				•	•	070 02 164.03	281.00
1500	EU / UK	•	UK	•			•	070 02 165.03	417.00
1500	EU / UK	•	UK		•		•	070 02 166.03	417.00
1500	EU / UK	•	UK			•	•	070 02 167.03	417.00
2000	EU / UK	•	UK	•			•	070 02 168.03	452.00
2000	EU / UK	•	UK		•		•	070 02 169.03	452.00
2000	EU / UK	•	UK			•	•	070 02 170.03	452.00
1500		•	EU	•				070 02 171.03	335.11
1500		•	EU		•			070 02 172.03	335.11
1500		•	EU			•		070 02 173.03	335.11
2000		•	EU	•				070 02 174.03	356.75
2000		•	EU		•			070 02 175.03	356.75
2000		•	EU			•		070 02 176.03	356.75
1500	EU / UK	•	EU	•			•	070 02 183.03	525.87
1500	EU / UK	•	EU		•		•	070 02 184.03	525.87
1500	EU / UK	•	EU			•	•	070 02 185.03	525.87
2000	EU / UK	•	EU	•			•	070 02 186.03	597.61
2000	EU / UK	•	EU		•		•	070 02 187.03	597.61
2000	EU / UK	•	EU			•	•	070 02 188.03	597.61

* For details of country-specific versions for other countries, please consult your local bott partner.
 ** On-site electrical installation must be referred to a qualified electrician.
 Individual components are available on request!

Workbench BMN

Dimensions: Width 700 x Depth 700 x Height 830 mm



- Load capacity 500 kg
- Sheet steel construction
- Choose from 2 worktop finishes (Thickness 30 mm)
- Load capacity per drawer 75 kg
- Supplied flat packed for self assembly. We can offer a full assembly service, please contact us for details.
- Frame size: W 624 x D 600 x H 800 mm
- Drawer divider systems – see page 210-225



With CS series drawer cabinets – see page 12/13 for more details



Description	Dimensions W x D x H mm	Worktop	Part ref.	Price £
BMNM 0707	700 x 700 x 830	Multiplex	100 70 012.16	169.00
BMNL 0707	700 x 700 x 830	Linoleum	100 70 011.16	195.00



Description	Dimensions W x D x H mm	Worktop	Part ref.	Price £
BMNM 0707 + CS 225-1	700 x 700 x 830	Multiplex	110 44 170.03	309.27
BMNL 0707 + CS 225-1	700 x 700 x 830	Linoleum	110 44 160.03	335.27



Description	Dimensions W x D x H mm	Worktop	Part ref.	Price £
BMNM 0707 + CS 425-3	700 x 700 x 830	Multiplex	110 44 171.03	414.39
BMNL 0707 + CS 425-3	700 x 700 x 830	Linoleum	110 44 161.03	440.39

Standard paint finish

Housing:	RAL 7035 light grey
Fronts:	RAL 5015 blue .03

Alternative front colours (no extra charge)

RAL 7035 light grey	RAL 7035 light grey	RAL 7035 light grey	RAL 7035 light grey	RAL 7035 light grey
RAL 7035 light grey .16	RAL 7001 grey .01	RAL 6011 green .02	RAL 3001 red .04	RAL 1023 yellow .12

(Please replace the order ref. suffix from .03 to that for your required colour)

Workbench BMN

Dimensions: Width 700 x Depth 700 x Height 830 mm



Description	Dimensions W x D x H mm	Worktop	Part ref.	Price £
BMNM 0707 + CS 650-1	700 x 700 x 830	Multiplex	110 44 172.03	353.32
BMNL 0707 + CS 650-1	700 x 700 x 830	Linoleum	110 44 162.03	379.32



Description	Dimensions W x D x H mm	Worktop	Part ref.	Price £
BMNM 0707 + CS 650-2	700 x 700 x 830	Multiplex	110 44 173.03	395.08
BMNL 0707 + CS 650-2	700 x 700 x 830	Linoleum	110 44 163.03	421.08



Description	Dimensions W x D x H mm	Worktop	Part ref.	Price £
BMNM 0707 + CS 650-3	700 x 700 x 830	Multiplex	110 44 174.03	439.63
BMNL 0707 + CS 650-3	700 x 700 x 830	Linoleum	110 44 164.03	465.63



Description	Dimensions W x D x H mm	Worktop	Part ref.	Price £
BMNM 0707 + CS 650-5	700 x 700 x 830	Multiplex	110 44 175.03	537.89
BMNL 0707 + CS 650-5	700 x 700 x 830	Linoleum	110 44 165.03	563.89

Standard paint finish

Housing:	RAL 7035 light grey
Fronts:	RAL 5015 blue .03

Alternative front colours (no extra charge)

RAL 7035 light grey	RAL 7035 light grey	RAL 7035 light grey	RAL 7035 light grey	RAL 7035 light grey
RAL 7035 light grey .16	RAL 7001 grey .01	RAL 6011 green .02	RAL 3001 red .04	RAL 1023 yellow .12

(Please replace the order ref. suffix from .03 to that for your required colour)

Drawer
Cabinets

Workbenches

Workstation
Systems APS

Mobile
Equipment

Storage
Cupboards

Combination Drawer
& Shelving System

Drawer
Dividers

Perfo® System

CNC System

Cases

Workbench BMN

Dimensions: Width 1500/2000 x Depth 700/900 x Height 830 mm



- Load capacity 500 kg
- Sheet steel construction
- Modular system with a wide range of accessories
- Choose from 2 worktop finishes (Thickness 30 mm)
- Load capacity per drawer 75 kg
- Optional Leg extension set (see page 72) allows height adjustment from 830 to 980 mm
- Supplied flat packed for self assembly. We can offer a full assembly service, please contact us for details.
- Frame size: W 1440/1940 x D 600/800 x H 800 mm
- Drawer divider systems see page 210-225



With CS series drawer cabinets – see page 12/13 for more details



Description	Dimensions W x D mm	Worktop	Part ref.	Price £
BMNM 1570	1500 x 700	Multiplex	110 44 301.16	178.87
BMNM 1590	1500 x 900	Multiplex	110 44 302.16	219.83
BMNM 2070	2000 x 700	Multiplex	110 44 303.16	223.13
BMNM 2090	2000 x 900	Multiplex	110 44 304.16	272.93
BMNL 1570	1500 x 700	Linoleum	110 44 305.16	212.18
BMNL 1590	1500 x 900	Linoleum	110 44 306.16	244.57
BMNL 2070	2000 x 700	Linoleum	110 44 307.16	249.29
BMNL 2090	2000 x 900	Linoleum	110 44 308.16	321.99



Description	Dimensions W x D mm	Worktop	Part ref.	Price £
BMNM 1570 + CS 225-1	1500 x 700	Multiplex	110 44 309.03	318.87
BMNM 1590 + CS 225-1	1500 x 900	Multiplex	110 44 310.03	359.83
BMNM 2070 + CS 225-1	2000 x 700	Multiplex	110 44 311.03	363.13
BMNM 2090 + CS 225-1	2000 x 900	Multiplex	110 44 312.03	412.93
BMNL 1570 + CS 225-1	1500 x 700	Linoleum	110 44 313.03	352.18
BMNL 1590 + CS 225-1	1500 x 900	Linoleum	110 44 314.03	384.57
BMNL 2070 + CS 225-1	2000 x 700	Linoleum	110 44 315.03	389.29
BMNL 2090 + CS 225-1	2000 x 900	Linoleum	110 44 316.03	461.99



Description	Dimensions W x D mm	Worktop	Part ref.	Price £
BMNM 1570 + CS 425-3	1500 x 700	Multiplex	110 44 317.03	423.87
BMNM 1590 + CS 425-3	1500 x 900	Multiplex	110 44 318.03	464.83
BMNM 2070 + CS 425-3	2000 x 700	Multiplex	110 44 319.03	468.13
BMNM 2090 + CS 425-3	2000 x 900	Multiplex	110 44 320.03	517.93
BMNL 1570 + CS 425-3	1500 x 700	Linoleum	110 44 321.03	457.18
BMNL 1590 + CS 425-3	1500 x 900	Linoleum	110 44 322.03	489.57
BMNL 2070 + CS 425-3	2000 x 700	Linoleum	110 44 323.03	494.29
BMNL 2090 + CS 425-3	2000 x 900	Linoleum	110 44 324.03	566.99

Standard paint finish

Housing:	RAL 7035 light grey
Fronts:	RAL 5015 blue .03

Alternative front colours (no extra charge)

RAL 7035 light grey	RAL 7035 light grey	RAL 7035 light grey	RAL 7035 light grey	RAL 7035 light grey
RAL 7035 light grey .16	RAL 7001 grey .01	RAL 6011 green .02	RAL 3001 red .04	RAL 1023 yellow .12

(Please replace the order ref. suffix from .03 to that for your required colour)

Workbench BMN

Dimensions: Width 1500/2000 x Depth 700/900 x Height 830 mm



Description	Dimensions W x D mm	Worktop	Part ref.	Price £
BMNM 1570 + CS 650-1	1500 x 700	Multiplex	110 44 325.03	362.87
BMNM 1590 + CS 650-1	1500 x 900	Multiplex	110 44 326.03	403.83
BMNM 2070 + CS 650-1	2000 x 700	Multiplex	110 44 327.03	407.13
BMNM 2090 + CS 650-1	2000 x 900	Multiplex	110 44 328.03	456.93
BMNL 1570 + CS 650-1	1500 x 700	Linoleum	110 44 329.03	396.18
BMNL 1590 + CS 650-1	1500 x 900	Linoleum	110 44 330.03	428.57
BMNL 2070 + CS 650-1	2000 x 700	Linoleum	110 44 331.03	433.29
BMNL 2090 + CS 650-1	2000 x 900	Linoleum	110 44 332.03	505.99



Description	Dimensions W x D mm	Worktop	Part ref.	Price £
BMNM 1570 + CS 650-2	1500 x 700	Multiplex	110 44 333.03	404.87
BMNM 1590 + CS 650-2	1500 x 900	Multiplex	110 44 334.03	445.83
BMNM 2070 + CS 650-2	2000 x 700	Multiplex	110 44 335.03	449.13
BMNM 2090 + CS 650-2	2000 x 900	Multiplex	110 44 336.03	498.93
BMNL 1570 + CS 650-2	1500 x 700	Linoleum	110 44 337.03	438.18
BMNL 1590 + CS 650-2	1500 x 900	Linoleum	110 44 338.03	470.57
BMNL 2070 + CS 650-2	2000 x 700	Linoleum	110 44 339.03	475.29
BMNL 2090 + CS 650-2	2000 x 900	Linoleum	110 44 340.03	547.99



Description	Dimensions W x D mm	Worktop	Part ref.	Price £
BMNM 1570 + CS 650-3	1500 x 700	Multiplex	110 44 341.03	449.87
BMNM 1590 + CS 650-3	1500 x 900	Multiplex	110 44 342.03	490.83
BMNM 2070 + CS 650-3	2000 x 700	Multiplex	110 44 343.03	494.13
BMNM 2090 + CS 650-3	2000 x 900	Multiplex	110 44 344.03	543.93
BMNL 1570 + CS 650-3	1500 x 700	Linoleum	110 44 345.03	483.18
BMNL 1590 + CS 650-3	1500 x 900	Linoleum	110 44 346.03	515.57
BMNL 2070 + CS 650-3	2000 x 700	Linoleum	110 44 347.03	520.29
BMNL 2090 + CS 650-3	2000 x 900	Linoleum	110 44 348.03	592.99

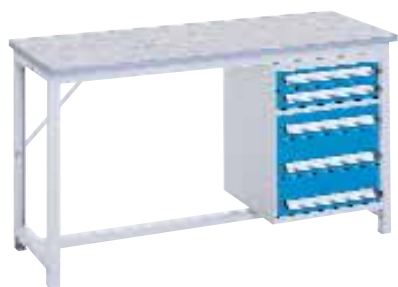

Description	Dimensions W x D mm	Worktop	Part ref.	Price £
BMNM 1570 + CS 650-5	1500 x 700	Multiplex	110 44 349.03	547.87
BMNM 1590 + CS 650-5	1500 x 900	Multiplex	110 44 350.03	588.83
BMNM 2070 + CS 650-5	2000 x 700	Multiplex	110 44 351.03	592.13
BMNM 2090 + CS 650-5	2000 x 900	Multiplex	110 44 352.03	641.93
BMNL 1570 + CS 650-5	1500 x 700	Linoleum	110 44 353.03	581.18
BMNL 1590 + CS 650-5	1500 x 900	Linoleum	110 44 354.03	613.57
BMNL 2070 + CS 650-5	2000 x 700	Linoleum	110 44 355.03	618.29
BMNL 2090 + CS 650-5	2000 x 900	Linoleum	110 44 356.03	690.99

Standard paint finish

Housing:	RAL 7035 light grey
Fronts:	RAL 5015 blue .03

Alternative front colours (no extra charge)

RAL 7035 light grey	RAL 7035 light grey	RAL 7035 light grey	RAL 7035 light grey	RAL 7035 light grey
RAL 7035 light grey .16	RAL 7001 grey .01	RAL 6011 green .02	RAL 3001 red .04	RAL 1023 yellow .12

(Please replace the order ref. suffix from .03 to that for your required colour)

Drawer
Cabinets

Workbenches

Workstation
Systems APS

Mobile
Equipment

Storage
Cupboards

Combination Drawer
& Shelving System

Drawer
Dividers

Perfo® System

CNC System

Cases

Accessories for workbench BMN

1500 and 2000 mm width only



Drawer Cabinets

Workbenches

Workstation Systems APS

Mobile Equipment

Storage Cupboards

Combination Drawer & Shelving System

Drawer Dividers

Perfo® System

CNC System

Cases

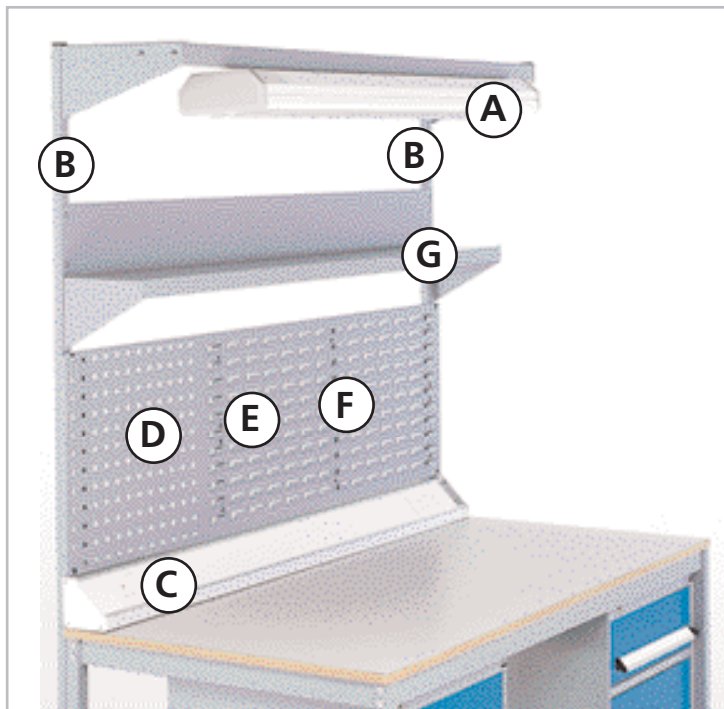















Fig.	Description	for workbench with dimensions	Part ref.	Price £
1	End modesty panel (pair)	W 1500/2000 x D 700 mm	122 05 029.16	42.00
	End modesty panel (pair)	W 1500/2000 x D 900 mm	122 05 030.16	50.00
2	Rear modesty panel (pair)	W 1500 mm	122 05 026.16	37.00
	Rear modesty panel (pair)	W 2000 mm	122 05 027.16	44.00
3	Base shelf (365 mm deep)	W 1500 mm	121 01 347.16	34.00
	Base shelf (365 mm deep)	W 2000 mm	121 01 348.16	45.00
4	Full shelf (730 mm deep)*	W 1500 mm	121 01 349.16	65.00
	Full shelf (730 mm deep)*	W 2000 mm	121 01 350.16	86.00
	*available only for depth 900 mm			
5	Height extension set	Height 150 mm	114 01 102.16	17.00

Accessories for workbench BMN



- A**  Overhead light and frame (UK or EU version)
- B**  Support brackets (2 piece) max. height 1200 mm
- C**  Power duct (UK or EU version) incl. 4 outlets
- D**  Perfo® perforated panel
- E**  Perfo® louvred panel
- F**  Perfo® combination panels
- G**  Metal shelf

Complete range consisting of:

	A	B	C	D	E	F	G	Part ref.	Price £
for workbench Width mm									
1500		•		•				070 02 147.03	67.00
1500		•			•			070 02 148.03	67.00
1500		•				•		070 02 149.03	67.00
2000		•		•				070 02 150.03	82.00
2000		•			•			070 02 151.03	82.00
2000		•				•		070 02 152.03	82.00
1500		•	UK	•				070 02 153.03	231.00
1500		•	UK		•			070 02 154.03	231.00
1500		•	UK			•		070 02 155.03	231.00
2000		•	UK	•				070 02 156.03	253.00
2000		•	UK		•			070 02 157.03	253.00
2000		•	UK			•		070 02 158.03	253.00
1500	EU / UK	•		•			•	070 02 159.03	253.00
1500	EU / UK	•			•		•	070 02 160.03	253.00
1500	EU / UK	•				•	•	070 02 161.03	253.00
2000	EU / UK	•		•			•	070 02 162.03	281.00
2000	EU / UK	•			•		•	070 02 163.03	281.00
2000	EU / UK	•				•	•	070 02 164.03	281.00
1500	EU / UK	•	UK	•			•	070 02 165.03	417.00
1500	EU / UK	•	UK		•		•	070 02 166.03	417.00
1500	EU / UK	•	UK			•	•	070 02 167.03	417.00
2000	EU / UK	•	UK	•			•	070 02 168.03	452.00
2000	EU / UK	•	UK		•		•	070 02 169.03	452.00
2000	EU / UK	•	UK			•	•	070 02 170.03	452.00
1500		•	EU	•				070 02 171.03	335.11
1500		•	EU		•			070 02 172.03	335.11
1500		•	EU			•		070 02 173.03	335.11
2000		•	EU	•				070 02 174.03	356.75
2000		•	EU		•			070 02 175.03	356.75
2000		•	EU			•		070 02 176.03	356.75
1500	EU / UK	•	EU	•			•	070 02 183.03	525.87
1500	EU / UK	•	EU		•		•	070 02 184.03	525.87
1500	EU / UK	•	EU			•	•	070 02 185.03	525.87
2000	EU / UK	•	EU	•			•	070 02 186.03	597.61
2000	EU / UK	•	EU		•		•	070 02 187.03	597.61
2000	EU / UK	•	EU			•	•	070 02 188.03	597.61

* For details of country-specific versions for other countries, please consult your local bott partner.
 ** On-site electrical installation must be referred to a qualified electrician.
 Individual components are available on request!

Drawer Cabinets
 Workbenches
 Workstation Systems APS
 Mobile Equipment
 Storage Cupboards
 Combination Drawer & Shelving System
 Drawer Dividers
 Perfo® System
 CNC System
 Cases

Workbench WPB

Dimensions: Width 1500/2000 x Depth 700/900 x Height 840 mm



- Perfect for engineering work
- Load capacity 300-400 kg depending on bench length
- Robust steel framework
- Choose from 2 worktop finishes (Thickness 40 mm)
- Load capacity per drawer 75 kg
- Supplied flat packed for self assembly. We can offer a full assembly service, please contact us for details.
- Frame size: W 1465/1965 x D 600/800 x H 800 mm
- Drawer divider systems see page 210-225



With CS series drawer cabinets – see page 12/13 for more details



Description	Dimensions W x D mm	Worktop	Part ref.	Price £
WPBM 1570	1500 x 700	Multiplex	110 02 076.16	192.95
WPBM 1590	1500 x 900	Multiplex	110 02 078.16	224.17
WPBM 2070	2000 x 700	Multiplex	110 02 080.16	243.10
WPBM 2090	2000 x 900	Multiplex	110 02 082.16	265.18
WPBL 1570	1500 x 700	Linoleum	110 02 075.16	234.96
WPBL 1590	1500 x 900	Linoleum	110 02 077.16	283.17
WPBL 2070	2000 x 700	Linoleum	110 02 079.16	301.08
WPBL 2090	2000 x 900	Linoleum	110 02 081.16	357.54



Description	Dimensions W x D mm	Worktop	Part ref.	Price £
WPBM 1570 + CS 225-1	1500 x 700	Multiplex	110 08 140.03	332.95
WPBM 1590 + CS 225-1	1500 x 900	Multiplex	110 08 146.03	364.17
WPBM 2070 + CS 225-1	2000 x 700	Multiplex	110 08 152.03	383.10
WPBM 2090 + CS 225-1	2000 x 900	Multiplex	110 08 158.03	405.18
WPBL 1570 + CS 225-1	1500 x 700	Linoleum	110 08 137.03	374.96
WPBL 1590 + CS 225-1	1500 x 900	Linoleum	110 08 143.03	423.17
WPBL 2070 + CS 225-1	2000 x 700	Linoleum	110 08 149.03	441.08
WPBL 2090 + CS 225-1	2000 x 900	Linoleum	110 08 155.03	497.54

Standard paint finish

Housing:	RAL 7035 light grey
Fronts:	RAL 5015 blue .03

Alternative front colours (no extra charge)

RAL 7035 light grey	RAL 7035 light grey	RAL 7035 light grey	RAL 7035 light grey	RAL 7035 light grey
RAL 7035 light grey .16	RAL 7001 grey .01	RAL 6011 green .02	RAL 3001 red .04	RAL 1023 yellow .12

(Please replace the order ref. suffix from .03 to that for your required colour)

Workbench WPB

Dimensions: Width 1500/2000 x Depth 700/900 x Height 840 mm



Description	Dimensions W x D mm	Worktop	Part ref.	Price £
WPBM 1570 + CS 800-4	1500 x 700	Multiplex	110 08 141.03	546.95
WPBM 1590 + CS 800-4	1500 x 900	Multiplex	110 08 147.03	578.17
WPBM 2070 + CS 800-4	2000 x 700	Multiplex	110 08 153.03	597.10
WPBM 2090 + CS 800-4	2000 x 900	Multiplex	110 08 159.03	619.18
WPBL 1570 + CS 800-4	1500 x 700	Linoleum	110 08 138.03	588.96
WPBL 1590 + CS 800-4	1500 x 900	Linoleum	110 08 144.03	637.17
WPBL 2070 + CS 800-4	2000 x 700	Linoleum	110 08 150.03	655.08
WPBL 2090 + CS 800-4	2000 x 900	Linoleum	110 08 156.03	711.54



Description	Dimensions W x D mm	Worktop	Part ref.	Price £
WPBM 1570 + CS 800-6	1500 x 700	Multiplex	110 08 142.03	646.95
WPBM 1590 + CS 800-6	1500 x 900	Multiplex	110 08 148.03	678.17
WPBM 2070 + CS 800-6	2000 x 700	Multiplex	110 08 154.03	697.10
WPBM 2090 + CS 800-6	2000 x 900	Multiplex	110 08 160.03	719.18
WPBL 1570 + CS 800-6	1500 x 700	Linoleum	110 08 139.03	688.96
WPBL 1590 + CS 800-6	1500 x 900	Linoleum	110 08 145.03	737.17
WPBL 2070 + CS 800-6	2000 x 700	Linoleum	110 08 151.03	755.08
WPBL 2090 + CS 800-6	2000 x 900	Linoleum	110 08 157.03	811.54

Standard paint finish

Housing:	RAL 7035 light grey
Fronts:	RAL 5015 blue .03

Alternative front colours (no extra charge)

RAL 7035 light grey	RAL 7035 light grey	RAL 7035 light grey	RAL 7035 light grey	RAL 7035 light grey
RAL 7035 light grey .16	RAL 7001 grey .01	RAL 6011 green .02	RAL 3001 red .04	RAL 1023 yellow .12

(Please replace the order ref. suffix from .03 to that for your required colour)

Drawer
Cabinets

Workbenches

Workstation
Systems APS

Mobile
Equipment

Storage
Cupboards

Combination Drawer
& Shelving System

Drawer
Dividers

Perfo® System

CNC System

Cases

Workbench WB

Dimensions: Width 1500/2000 x Depth 700 x Height 840 mm



- Suitable for heavy assembly work
- Load capacity 150-1500 kg depending on worktop version
- Choose from 2 worktop finishes (Thickness 40 mm)
- Load capacity per drawer 100 kg
- Drawer divider systems see page 210-225
- Supplied flat packed for self assembly. We can offer a full assembly service, please contact us for details.



With CK and CM series drawer cabinets – see page 24/25 and 30/31 for more details

Description	Dimensions W x D x H mm	Worktop	Part ref.	Price £
WBM 40 1570-0.1	1500 x 700 x 840	Multiplex	110 01 052.16	201.74
WBM 40 2070-0.1	2000 x 700 x 840	Multiplex	110 01 054.16	239.16
WBL 40 1570-0.1	1500 x 700 x 840	Linoleum	110 01 064.16	265.15
WBL 40 2070-0.1	2000 x 700 x 840	Linoleum	110 01 065.16	306.37



Shelf

Description	Dimensions W x D x H mm	Worktop	Part ref.	Price £
WBM 40 1570-0.5	1500 x 700 x 840	Multiplex	110 03 050.16	243.04
WBM 40 2070-0.5	2000 x 700 x 840	Multiplex	110 03 052.16	313.11
WBL 40 1570-0.5	1500 x 700 x 840	Linoleum	110 03 080.16	319.51
WBL 40 2070-0.5	2000 x 700 x 840	Linoleum	110 03 081.16	380.32



CM 400-3.1

Description	Dimensions W x D x H mm	Worktop	Part ref.	Price £
WBM 40 1570-3.1	1500 x 700 x 840	Multiplex	110 07 069.03	483.71
WBM 40 2070-3.1	2000 x 700 x 840	Multiplex	110 07 073.03	524.58
WBL 40 1570-3.1	1500 x 700 x 840	Linoleum	110 07 080.03	560.50
WBL 40 2070-3.1	2000 x 700 x 840	Linoleum	110 07 081.03	605.16

Standard paint finish

Housing:	RAL 7035 light grey
Fronts:	RAL 5015 blue .03

Alternative front colours (no extra charge)

RAL 7035 light grey	RAL 7035 light grey	RAL 7035 light grey	RAL 7035 light grey	RAL 7035 light grey
RAL 7035 light grey .16	RAL 7001 grey .01	RAL 6011 green .02	RAL 3001 red .04	RAL 1023 yellow .12

(Please replace the order ref. suffix from .03 to that for your required colour)

Workbench WB

Dimensions: Width 1500/2000 x Depth 700 x Height 840 mm



CM 800-5.2

Description	Dimensions W x D x H mm	Worktop	Part ref.	Price £
WBM 40 1570-5.2	1500 x 700 x 840	Multiplex	110 13 181.03	575.13
WBM 40 2070-5.2	2000 x 700 x 840	Multiplex	110 13 188.03	613.43
WBL 40 1570-5.2	1500 x 700 x 840	Linoleum	110 13 210.03	651.60
WBL 40 2070-5.2	2000 x 700 x 840	Linoleum	110 13 213.03	692.81



CM 800-6.1

Description	Dimensions W x D x H mm	Worktop	Part ref.	Price £
WBM40 1570-6.1	1500 x 700 x 840	Multiplex	110 13 182.03	636.98
WBM40 2070-6.1	2000 x 700 x 840	Multiplex	110 13 189.03	904.64
WBL40 1570-6.1	1500 x 700 x 840	Linoleum	110 13 211.03	713.88
WBL40 2070-6.1	2000 x 700 x 840	Linoleum	110 13 214.03	747.12



CK 800-5.1

CK 800R-4.1

Description	Dimensions W x D x H mm	Worktop	Part ref.	Price £
WBM 40 2070-9.1	2000 x 700 x 840	Multiplex	110 13 190.03	914.55
WBL 40 2070-9.1	2000 x 700 x 840	Linoleum	110 13 215.03	994.82

Standard paint finish

Housing:	RAL 7035 light grey
Fronts:	RAL 5015 blue .03

Alternative front colours (no extra charge)

RAL 7035 light grey	RAL 7035 light grey	RAL 7035 light grey	RAL 7035 light grey	RAL 7035 light grey
RAL 7035 light grey .16	RAL 7001 grey .01	RAL 6011 green .02	RAL 3001 red .04	RAL 1023 yellow .12

(Please replace the order ref. suffix from .03 to that for your required colour)

Drawer
Cabinets

Workbenches

Workstation
Systems APS

Mobile
Equipment

Storage
Cupboards

Combination Drawer
& Shelving System

Drawer
Dividers

Perfo® System

CNC System

Cases

Workbench WB

Dimensions: Width 1500/2000 x Depth 700 x Height 790–940 mm



- Suitable for assembly work
- continuous height adjustment from 790-940 mm
- Choose from 2 worktop finishes (Thickness 40 mm)
- Load capacity per drawer 100 kg (except S1)
- Supplied flat packed for self assembly. We can offer a full assembly service, please contact us for details.
- Drawer divider systems see page 210-225

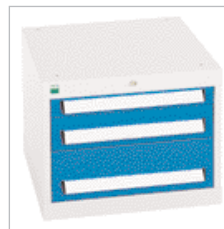

With CK and CM series drawer cabinets – see page 24/25 and 30/31 for more details



Description	Dimensions W x D x H mm	Worktop	Part ref.	Price £
WBM 1570-1.1	1500 x 700 x 790-940	Multiplex	110 04 022.16	298.56
WBM 2070-1.1	2000 x 700 x 790-940	Multiplex	110 04 024.16	335.99
WBL 1570-1.1	1500 x 700 x 790-940	Linoleum	110 04 027.16	409.37
WBL 2070-1.1	2000 x 700 x 790-940	Linoleum	110 04 028.16	381.93

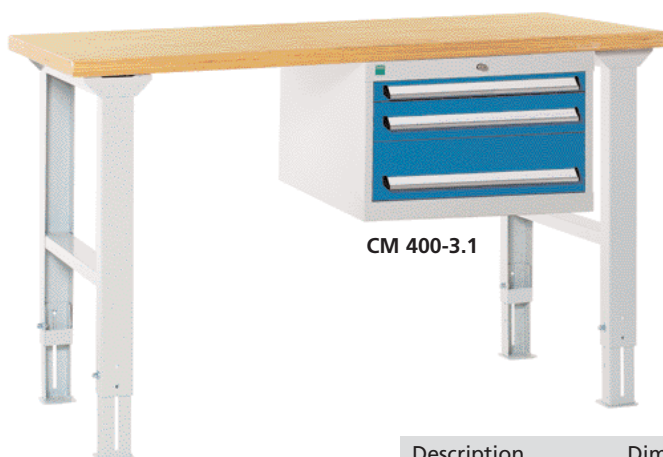

Description	Dimensions W x D x H mm	Worktop	Part ref.	Price £
WBM 40 1570-3.3	1500 x 700 x 790-940	Multiplex	110 07 070.03	483.99
WBM 40 2070-3.3	2000 x 700 x 790-940	Multiplex	110 07 072.03	536.13
WBL 40 1570-3.3	1500 x 700 x 790-940	Linoleum	110 07 082.03	560.68
WBL 40 2070-3.3	2000 x 700 x 790-940	Linoleum	110 07 083.03	612.24

Standard paint finish

Housing:	RAL 7035 light grey
Fronts:	RAL 5015 blue .03

Alternative front colours (no extra charge)

RAL 7035 light grey	RAL 7035 light grey	RAL 7035 light grey	RAL 7035 light grey	RAL 7035 light grey
RAL 7035 light grey .16	RAL 7001 grey .01	RAL 6011 green .02	RAL 3001 red .04	RAL 1023 yellow .12

(Please replace the order ref. suffix from .03 to that for your required colour)

Workbench WB

Dimensions: Width 1500/2000 x Depth 700 x Height 940 mm



CM 900-6.2

Description	Dimensions W x D x H mm	Worktop	Part ref.	Price £
WBM 40 1570-6.3	1500 x 700 x 940	Multiplex	110 13 186.03	628.21
WBM 40 2070-6.3	2000 x 700 x 940	Multiplex	110 13 193.03	663.77
WBL 40 1570-6.3	1500 x 700 x 940	Linoleum	110 13 212.03	704.66
WBL 40 2070-6.3	2000 x 700 x 940	Linoleum	110 13 216.03	744.59



CK 900-6.1

CK 900R-4.1

Description	Dimensions W x D x H mm	Worktop	Part ref.	Price £
WBM 40 2070-10.1	2000 x 700 x 940	Multiplex	110 13 194.03	935.89
WBL 40 2070-10.1	2000 x 700 x 940	Linoleum	110 13 217.03	1018.32

Standard paint finish

Housing:	RAL 7035 light grey
Fronts:	RAL 5015 blue .03

Alternative front colours (no extra charge)

RAL 7035 light grey	RAL 7035 light grey	RAL 7035 light grey	RAL 7035 light grey	RAL 7035 light grey
RAL 7035 light grey .16	RAL 7001 grey .01	RAL 6011 green .02	RAL 3001 red .04	RAL 1023 yellow .12

(Please replace the order ref. suffix from .03 to that for your required colour)

Drawer
Cabinets

Workbenches

Workstation
Systems APS

Mobile
Equipment

Storage
Cupboards

Combination Drawer
& Shelving System

Drawer
Dividers

Perfo® System

CNC System

Cases

Drawer Cabinets

Workbenches

Workstation Systems APS

Mobile Equipment

Storage Cupboards

Combination Drawer & Shelving System

Drawer Dividers

Perfo® System

CNC System

Cases



Hexagonal group workstations

Dimensions: Width 2500 x Depth 2165 x Height 840/940 mm

- Space: Width 2500 x Depth 2165 mm
- Height: 840 and 940 mm
- Worktop type: Beech multiplex, 40 mm Edge Length 1250 mm
- Central locking mechanism with 2 keys
- Load capacity per drawer: 100 kg – Normal slide
- Drawer pan internal measurements: W 520 x D 520 mm
- Drawer blocking mechanism is optionally available
- Drawer dividers – see page 210-225

SWM40-1250-30.1– with working height 840 mm

Cabinet measurements: W 600 x D 600 x H 800 mm

Drawer configuration: 2 x 100, 2 x 150, 1 x 200 mm



SWM40-1250-36.1– with working height 940 mm

Cabinet measurements: W 600 x D 600 x H 900 mm

Drawer configuration: 1 x 50, 1 x 100, 3 x 150, 1 x 200 mm



Description	Dimensions W x D x H mm	with cabinet type	Part ref.	Price £
SWM40 1250-30.1	2500 x 2165 x 840	6x CM 800-5.2	110 24 006.03	3426.10
SWM40 1250-36.1	2500 x 2165 x 940	6x CM 900-6.1	110 24 008.03	3787.48

Standard paint finish

Housing:	RAL 7035 light grey
Fronts:	RAL 5015 blue .03

Alternative front colours (no extra charge)

RAL 7035 light grey	RAL 7035 light grey	RAL 7035 light grey	RAL 7035 light grey	RAL 7035 light grey
RAL 7035 light grey .16	RAL 7001 grey .01	RAL 6011 green .02	RAL 3001 red .04	RAL 1023 yellow .12

(Please replace the order ref. suffix from .03 to that for your required colour)

Drawer Cabinets

Workbenches

Workstation Systems APS

Mobile Equipment

Storage Cupboards

Combination Drawer & Shelving System

Drawer Dividers

Perfo® System

CNC System

Cases

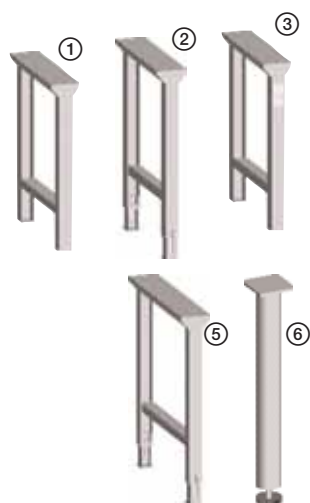

Workbench legs

Fig.	Description	Dimensions W x D x H mm	Part ref.	Price £
①	F1 - fixed height	160/80 x 640 x 800	114 01 028.16	33.47
②	F2 - adjustable height*	160/80 x 640 x 750-900	114 01 029.16	37.18
③	F3 - can be configured with electrical accessories**	160/80 x 640 x 800	114 01 030.16	44.61
⑤	F5 - adjustable height*	160/80 x 820 x 750-900	114 01 091.16	45.73
⑥	F6 - round, incl. levelling foot	Ø 80 x H 200-1500*	114 01 076.16	48.38

* Please specify required height when ordering

** Contact your local bott partner for details.



Worktops

Further versions on request.

Description	Dimensions W x D x S mm	Part ref.	Price £
Hexagonal-worktop, Beech multiplex 40 mm Edge length 1250 mm, 2 pieces	2500 x 2165 x 40	112 01 086.08	766.42
Hexagonal-worktop, Beech 40 mm Edge length 1250 mm, 2 pieces	2500 x 2165 x 40	112 01 086.07	1253.73
Hexagonal-worktop, Beech multiplex 50 mm Edge length 1250 mm, 2 pieces	2500 x 2165 x 50	112 01 087.08	826.76

Sheet-steel tool storage shelves



Beech multiplex shelves



Description	for workbench	Dimensions W x D x H mm	Part ref.	Price £
Shelf WZ 5	WB 1570 – with 1 base cabinet CM	835 x 480 x 22	121 01 116.16	73.51
Shelf WZ 6	WB 1570 – without base cabinet	1335 x 480 x 22	121 01 117.16	88.08
Shelf WZ 6	WB 2070 – with 1 base cabinet CM	1335 x 480 x 22	121 01 117.16	88.08
Shelf WZ 7	WB 2070 – without base cabinet	1835 x 480 x 22	121 01 118.16	112.34
Shelf	WB 1570 – without base cabinet	1410 x 280 x 25	112 01 076	55.40
Shelf	WB 1570 – without base cabinet	1410 x 530 x 25	112 01 074	77.01
Shelf	WB 2070 – without base cabinet	1910 x 280 x 25	112 01 077	79.08
Shelf	WB 2070 – without base cabinet	1910 x 530 x 25	112 01 075	108.60

Workbench accessories and individual components for WB and hexagonal group workstations

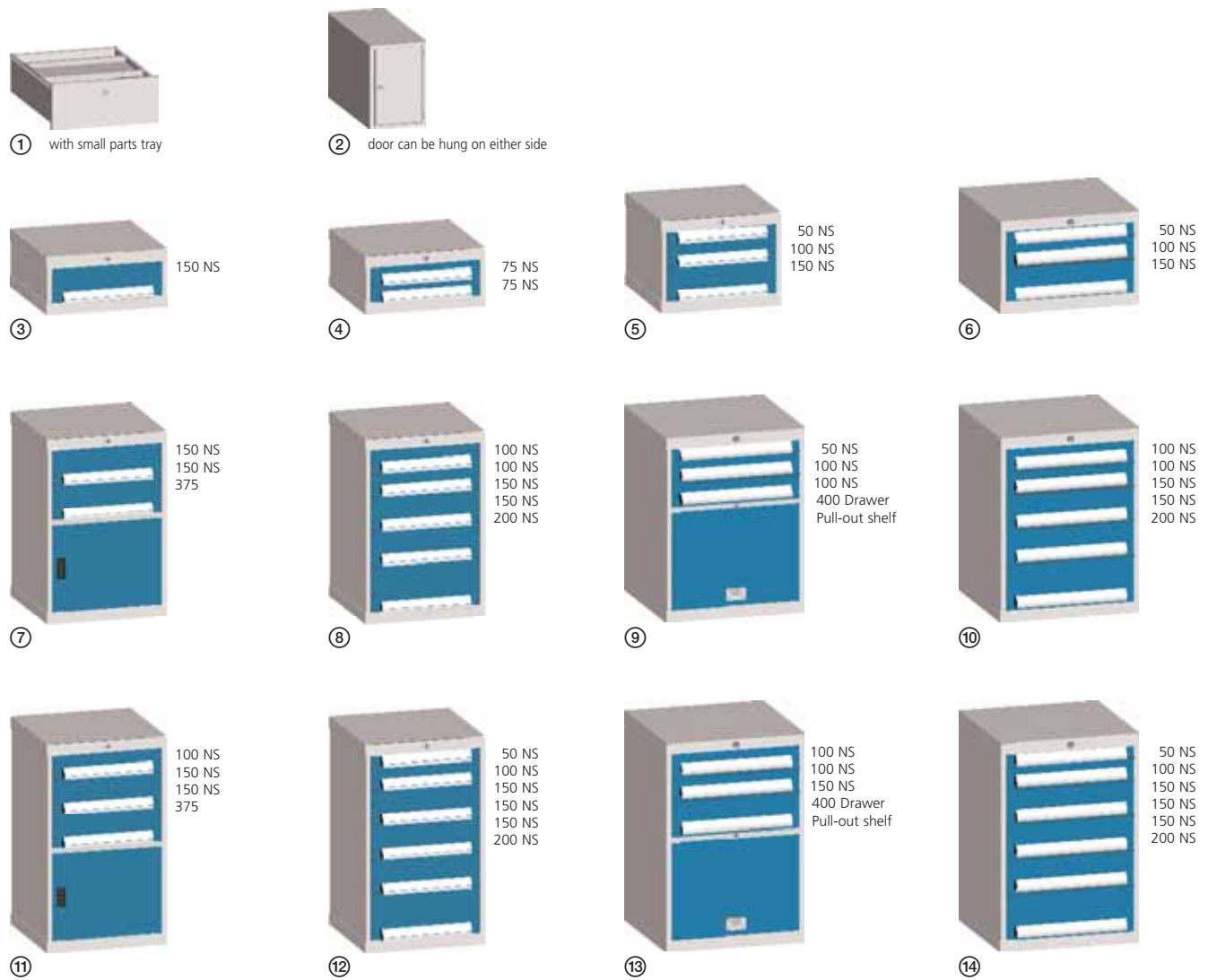

Fig.	Description	Dimensions W x D x H mm	Part ref.	Price £
①	S1-Single drawer	470 x 600 x 200	105 59 001.16	109.47
②	V1 Cupboard	242 x 600 x 360	100 33 004.16	67.17
③	CK-250-1.1	520 x 520 x 250	100 27 020.03	167.63
④	CK-250-2.1	520 x 520 x 250	100 27 021.03	186.88
⑤	CK-400-3.1	520 x 520 x 400	100 27 023.03	262.00
⑥	CM-400-3.1	600 x 600 x 400	100 02 088.03	300.00
⑦	CK-800R-3.1	520 x 520 x 800	100 18 512.03	381.97
⑧	CK-800-5.1	520 x 520 x 800	100 27 027.03	363.00
⑨	CM-801-4.1	600 x 600 x 800	100 15 008.03	455.00
⑩	CM-800-5.2	600 x 600 x 800	100 02 093.03	422.00
⑪	CK-900R-4.1	520 x 520 x 900	100 18 514.03	440.00
⑫	CK-900-6.1	520 x 520 x 900	100 27 031.03	412.00
⑬	CM-901-4.1	600 x 600 x 900	100 15 009.03	474.00
⑭	CM-900-6.1	600 x 600 x 900	100 02 097.03	494.00

For drawer dividers – see page 210-225.

Standard paint finish

Housing:	RAL 7035 light grey
Fronts:	RAL 5015 blue .03

Alternative front colours (no extra charge)

RAL 7035 light grey	RAL 7035 light grey	RAL 7035 light grey	RAL 7035 light grey	RAL 7035 light grey
RAL 7035 light grey .16	RAL 7001 grey .01	RAL 6011 green .02	RAL 3001 red .04	RAL 1023 yellow .12

(Please replace the order ref. suffix from .03 to that for your required colour)

Drawer
Cabinets

Workbenches

Workstation
Systems APS

Mobile
Equipment

Storage
Cupboards

Combination Drawer
& Shelving System

Drawer
Dividers

Perfo® System

CNC System

Cases

Workbench WL

Dimensions: Width 1500/2000 x Depth 700 x Height 840 mm



Drawer Cabinets

Workbenches

Workstation Systems APS

Mobile Equipment

Storage Cupboards

Combination Drawer & Shelving System

Drawer Dividers

Perfo® System

CNC System

Cases

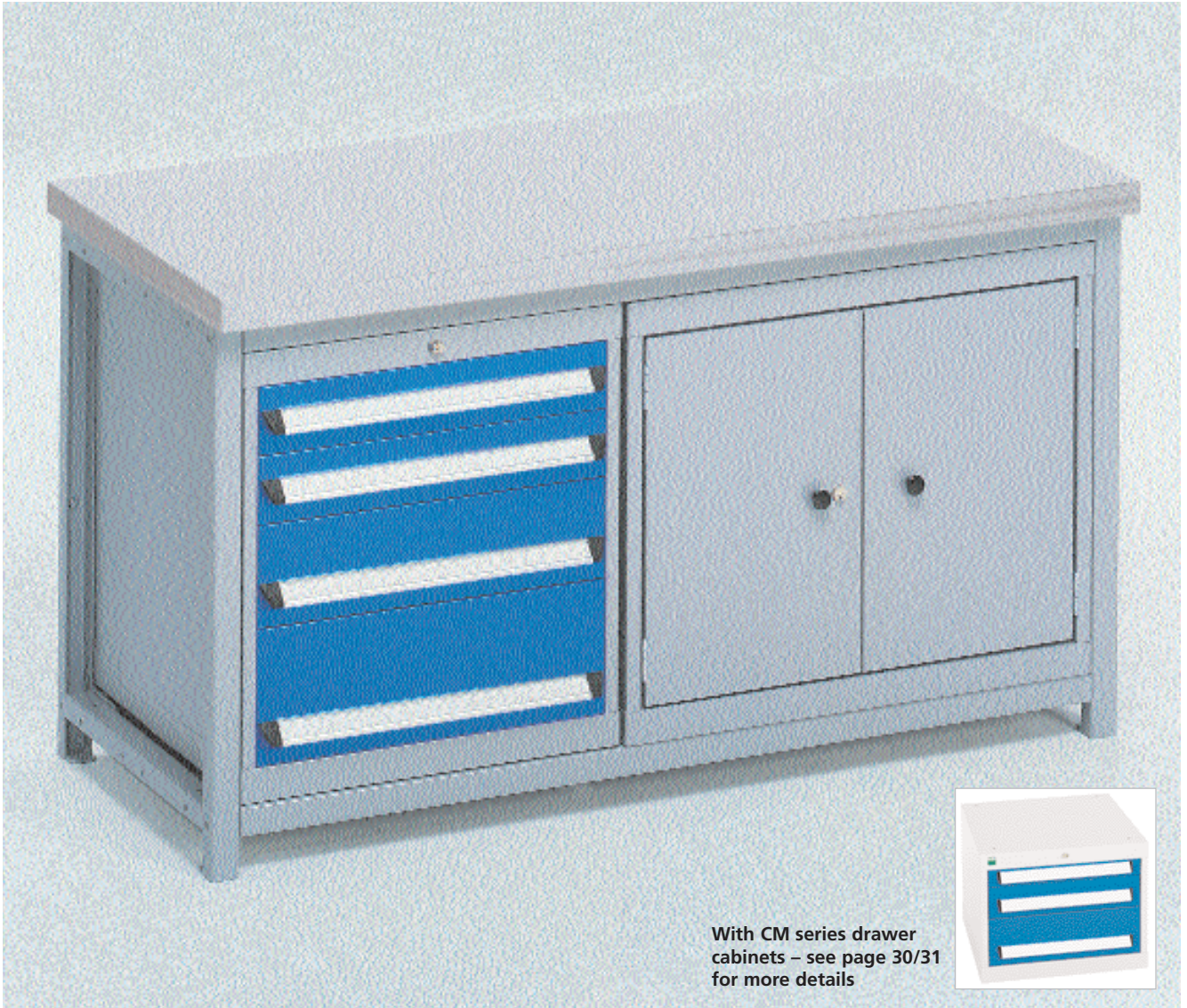

With CM series drawer cabinets – see page 30/31 for more details

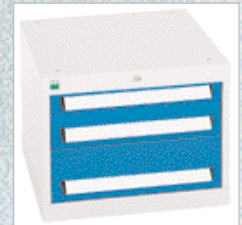

- Suitable for heavy assembly work
- Load capacity 600-1200 kg depending on worktop version
- Sturdy steel frame
- Choose from 2 worktop finishes (Thickness 40 mm)
- Load capacity per drawer 100 kg
- Supplied flat packed for self assembly. We can offer a full assembly service, please contact us for details.
- Frame size: W 1480 x D 600 x H 800 mm
- Drawer divider systems see page 210-225

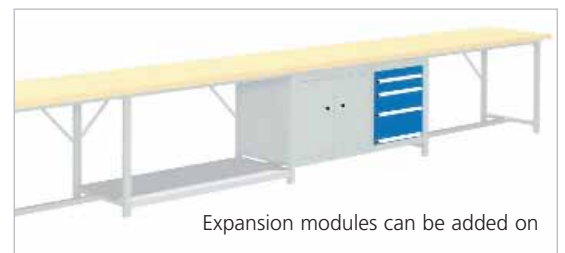

Expansion modules can be added on



Description	Dimensions W x D x H mm	Worktop	Part ref.	Price £
WLM 40 1570-0.1	1500 x 700 x 840	Multiplex	110 02 048.16	215.72
WLM 40 2070-0.1	2000 x 700 x 840	Multiplex	110 02 049.16	257.90
WLL 40 1570-0.1	1500 x 700 x 840	Linoleum	110 02 083.16	312.60
WLL 40 2070-0.1	2000 x 700 x 840	Linoleum	110 02 084.16	338.19

Workbench WL

Dimensions: Width 1500/2000 x Depth 700 x Height 840 mm



Description	Dimensions W x D x H mm	Worktop	Part ref.	Price £
WLM 40 1570-0.2	1500 x 700 x 840	Multiplex	110 03 054.16	250.29
WLM 40 2070-0.2	2000 x 700 x 840	Multiplex	110 03 055.16	296.55
WLL 40 1570-0.2	1500 x 700 x 840	Linoleum	110 03 082.16	250.29
WLL 40 2070-0.2	2000 x 700 x 840	Linoleum	110 03 083.16	376.86



Description	Dimensions W x D x H mm	Worktop	Part ref.	Price £
WLM 40 1570-4.1	1500 x 700 x 840	Multiplex	110 08 129.03	575.09
WLM 40 2070-4.1	2000 x 700 x 840	Multiplex	110 08 133.03	612.59
WLL 40 1570-4.1	1500 x 700 x 840	Linoleum	110 08 258.03	666.13
WLL 40 2070-4.1	2000 x 700 x 840	Linoleum	110 08 259.03	707.46

Drawer configuration (Normal slide):
2 x 100, 1 x 150, 1 x 200 mm



Description	Dimensions W x D x H mm	Worktop	Part ref.	Price £
WLM 40 1570-5.1	1500 x 700 x 840	Multiplex	110 16 133.03	647.08
WLM 40 2070-5.1	2000 x 700 x 840	Multiplex	110 16 132.03	770.43
WLL 40 1570-5.1	1500 x 700 x 840	Linoleum	110 16 185.03	868.28
WLL 40 2070-5.1	2000 x 700 x 840	Linoleum	110 16 186.03	914.29

Drawer configuration (Normal slide):
2 x 100, 1 x 150, 1 x 200 mm
Double door cupboard with shelf



Standard paint finish

Housing:	RAL 7035 light grey
Fronts:	RAL 5015 blue .03

Alternative front colours (no extra charge)

RAL 7035 light grey	RAL 7035 light grey	RAL 7035 light grey	RAL 7035 light grey	RAL 7035 light grey
RAL 7035 light grey .16	RAL 7001 grey .01	RAL 6011 green .02	RAL 3001 red .04	RAL 1023 yellow .12

(Please replace the order ref. suffix from .03 to that for your required colour)

Drawer
Cabinets

Workbenches

Workstation
Systems APS

Mobile
Equipment

Storage
Cupboards

Combination Drawer
& Shelving System

Drawer
Dividers

Perfo® System

CNC System

Cases

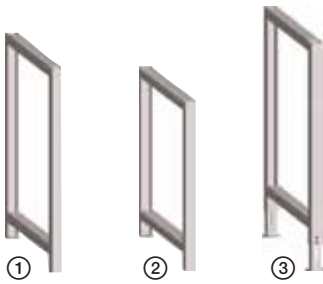

Workbench legs

Fig.	Description	Dimensions W x D x H mm	Part ref.	Price £
①	FL1 (O/M = 1 pce.)	45 x 600 x 800	114 01 032.16	19.33
	FL1 (O/M = 2 pcs.)	45 x 600 x 800	114 01 046.16	38.66
②	FL2 (O/M = 1 pce.)	45 x 600 x 665	114 01 040.16	17.11
	FL2 (O/M = 2 pcs.)	45 x 600 x 665	114 01 047.16	34.20
③	FL3 (O/M = 1 pce.)	45 x 600 x 800-950	114 01 069.16	40.61



Cross member set

set 1 for worktables WL-1570: 2 x cross member top, 1 x cross member bottom

set 2 for worktables WL-2070: 2 x cross member top, 1 x cross member bottom

set 3 for worktables WL-1570: 2 x cross member top (Shelf must be ordered separately)

set 4 for worktables WL-2070: 2 x cross member top (Shelf must be ordered separately)

Description	for worktable Width mm	Part ref.	Price £
set 1 – 2x cross member top, 1x cross member bottom	1500	121 10 055.16	33.47
set 2 – 2 x cross member top, 1 x cross member bottom	2000	121 10 057.16	41.64
set 3 – 2 x cross member top	1500	121 10 060.16	23.79
set 4 – 2 x cross member top	2000	121 10 061.16	29.74

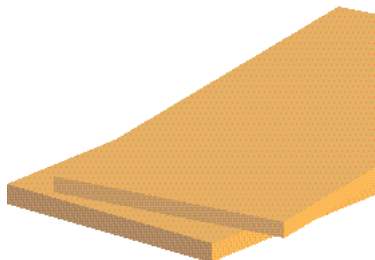

Worktops

For full descriptions and other worktops please refer to page 100-104

Description	Dimensions W x D x H mm	Part ref.	Price £
Worktop Beech multiplex, 30 mm	1500 x 700 x 30	112 01 114.08	96.00
Worktop Beech multiplex, 30 mm	2000 x 700 x 30	112 01 118.08	133.00
Worktop Beech multiplex, 40 mm	1500 x 700 x 40	112 01 003.08	101.00
Worktop Beech multiplex, 40 mm	2000 x 700 x 40	112 01 006.08	139.00
Worktop Beech multiplex, 50 mm	1500 x 700 x 50	112 01 002.08	139.26
Worktop Beech multiplex, 50 mm	2000 x 700 x 50	112 01 005.08	200.47



Shelves

sheet steel 45 mm thick

Description	for worktable	Dimensions W x D x H mm	Part ref.	Price £
WZ1	WL-1570	1390 x 360 x 45	121 01 119.16	37.35
WZ2	WL-2070	1890 x 360 x 45	121 01 120.16	44.02
WZ3	WL-1570	1390 x 600 x 45	121 01 121.16	63.49
WZ4	WL-2070	1890 x 600 x 45	121 01 122.16	61.58

Workbench accessories and individual components for WL



① with small parts tray



② door can be hung on either side



③ 150 NS



④ 75 NS
75 NS

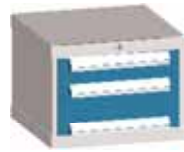

⑤ 50 NS
100 NS
150 NS



⑥ 50 NS
100 NS
150 NS



Hinged door
Shelf

⑦



⑧

⑧ **Support rail TL 1**
for fitting cabinets to the underside
of bench frameworks
for V 1 - 1 piece
for S 1 and cabinets - 2 piece

Fig.	Description	Dimensions W x D x H mm	Part ref.	Price £
①	S1-Single drawer	470 x 600 x 200	105 59 001.16	109.47
②	V1-Cupboard	242 x 600 x 360	100 33 004.16	67.17
③	CK-250-1.1	520 x 520 x 250	100 27 020.03	167.63
④	CK-250-2.1	520 x 520 x 250	100 27 021.03	186.88
⑤	CK-400-3.1	520 x 520 x 400	100 27 023.03	262.00
⑥	CM-400-3.1	600 x 600 x 400	100 02 088.03	300.00
⑦	FS 1	780 x 600 x 650	100 18 041.16	223.44
⑧	TL 1		121 10 054.16	3.34

Drawer divider systems – see page 210-225.

Standard paint finish

Housing:	RAL 7035 light grey
Fronts:	RAL 5015 blue .03

Alternative front colours (no extra charge)

RAL 7035 light grey	RAL 7035 light grey	RAL 7035 light grey	RAL 7035 light grey	RAL 7035 light grey
RAL 7035 light grey .16	RAL 7001 grey .01	RAL 6011 green .02	RAL 3001 red .04	RAL 1023 yellow .12

(Please replace the order ref. suffix from .03 to that for your required colour)

Drawer
Cabinets

Workbenches

Workstation
Systems APS

Mobile
Equipment

Storage
Cupboards

Combination Drawer
& Shelving System

Drawer
Dividers

Perfo® System

CNC System

Cases

Drawer
Cabinets

Workbenches

Workstation
Systems APS

Mobile
Equipment

Storage
Cupboards

Combination Drawer
& Shelving System

Drawer
Dividers

Perfo® System

CNC System

Cases



»Mobility kit«



cannot be used in combination with the height adjustment kit, 4 pieces, 4 swivel castors Ø 100 mm, 2 castors having locking brakes. Height 120 mm.

Description	Part ref.	Price £
Mobility kit	809 06 008	64.02

»Height adjustment kit«

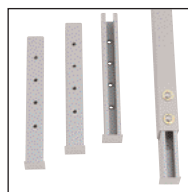

Cannot be used in combination with the mobility kit, 4 pieces, Adjustment range 0-150 mm in 50 mm increments or infinitely variable, Height adjustable from 800 to 950 mm (without plate). Can be used to adjust bench.

Description	Part ref.	Price £
Height adjustment kit	080 30 462.16	23.13

Modular workbenches KWB



Dimensions: Width 750 x Depth 700 x Height 840 mm

- Suitable for heavy assembly work
- Load capacity 600-1200 kg depending on worktop version
- Sturdy steel base frame
- Choose from 2 worktop finishes (Thickness 40 mm)
- Modular system that can be expanded as required.
- Load capacity per drawer 100 kg – Normal slide
- Drawer pan internal measurements W 520 x D 520 mm
- Drawer divider systems see page 210-225
- Central locking mechanism for doors and drawers
- Delivered assembled
- 230 mm floor clearance



Description	Dimensions W x D x H mm	Worktop	Part ref.	Price £
KWBM 40 0770M-0.1	750 x 700 x 840	Multiplex	110 03 072.16	383.80
KWBL 40 0770M-0.1	750 x 700 x 840	Linoleum	110 03 084.16	450.71
incl. 1 Shelf				



Description	Dimensions W x D x H mm	Worktop	Part ref.	Price £
KWBM 40 0770M-1.1	750 x 700 x 840	Multiplex	110 16 169.03	420.03
KWBL 40 0770M-1.1	750 x 700 x 840	Linoleum	110 16 187.03	486.96
1 x Door 500 mm, incl. 1 Shelf				



Description	Dimensions W x D x H mm	Worktop	Part ref.	Price £
KWBM 40 0770M-2.1	750 x 700 x 840	Multiplex	110 16 170.03	442.84
KWBL 40 0770M-2.1	750 x 700 x 840	Linoleum	110 16 188.03	510.25
1 x Door 350 mm, 1 x Drawer 150 mm				



Description	Dimensions W x D x H mm	Worktop	Part ref.	Price £
KWBM 40 0770M-3.1	750 x 700 x 840	Multiplex	110 09 066.03	500.88
KWBL 40 0770M-3.1	750 x 700 x 840	Linoleum	110 09 072.03	567.79
2 x Drawer 150 mm, 1 x Drawer 200 mm				

Standard paint finish

Housing:	RAL 7035 light grey
Fronts:	RAL 5015 blue .03

Alternative front colours (no extra charge)

RAL 7035 light grey	RAL 7035 light grey	RAL 7035 light grey	RAL 7035 light grey	RAL 7035 light grey
RAL 7035 light grey .16	RAL 7001 grey .01	RAL 6011 green .02	RAL 3001 red .04	RAL 1023 yellow .12

(Please replace the order ref. suffix from .03 to that for your required colour)

Drawer
Cabinets

Workbenches

Workstation
Systems APS

Mobile
Equipment

Storage
Cupboards

Combination Drawer
& Shelving System

Drawer
Dividers

Perfo® System

CNC System

Cases

Modular workbenches KWB

Dimensions: Width 1500 x Depth 700 x Height 840 mm



- Suitable for heavy assembly work
- Load capacity 600-1200 kg depending on worktop version
- Sturdy steel base frame
- Choose from 2 worktop finishes (Thickness 40 mm)
- Modular system that can be expanded as required.
- Load capacity per drawer 100 kg – Normal slide
- Drawer pan internal measurements W 520 x D 520 mm
- Drawer divider systems – see page 210-225
- Central locking mechanism for doors and drawers
- Delivered assembled
- 230 mm floor clearance

Drawer Cabinets

Workbenches

Workstation Systems APS

Mobile Equipment

Storage Cupboards

Combination Drawer & Shelving System

Drawer Dividers

Perfo® System

CNC System

Cases



Description	Dimensions W x D x H mm	Worktop	Part ref.	Price £
KWBM 40 1570M-0.1	1500 x 700 x 840	Multiplex	110 03 017.16	478.44
KWBL 40 1570M-0.1	1500 x 700 x 840	Linoleum	110 03 085.16	571.91
incl. 2 Shelves				



Description	Dimensions W x D x H mm	Worktop	Part ref.	Price £
KWBM 40 1570M-1.1	1500 x 700 x 840	Multiplex	110 16 094.03	505.72
KWBL 40 1570M-1.1	1500 x 700 x 840	Linoleum	110 16 189.03	607.66
1 x Door 500 mm, incl. 1 Shelf				



Description	Dimensions W x D x H mm	Worktop	Part ref.	Price £
KWBM 40 1570M-2.1	1500 x 700 x 840	Multiplex	110 16 097.03	513.20
KWBL 40 1570M-2.1	1500 x 700 x 840	Linoleum	110 16 190.03	536.20
2 x Door 500 mm, incl. 2 Shelves				

Standard paint finish

Housing:	RAL 7035 light grey
Fronts:	RAL 5015 blue .03

Alternative front colours (no extra charge)

RAL 7035 light grey	RAL 7035 light grey	RAL 7035 light grey	RAL 7035 light grey	RAL 7035 light grey
RAL 7035 light grey .16	RAL 7001 grey .01	RAL 6011 green .02	RAL 3001 red .04	RAL 1023 yellow .12

(Please replace the order ref. suffix from .03 to that for your required colour)

Modular workbenches KWB

Dimensions: Width 1500 x Depth 700 x Height 840 mm



Description	Dimensions W x D x H mm	Worktop	Part ref.	Price £
KWBM 40 1570M-3.1	1500 x 700 x 840	Multiplex	110 16 103.03	592.83
KWBL 40 1570M-3.1	1500 x 700 x 840	Linoleum	110 16 191.03	669.32
1 x Drawer 150 mm, 1 x Door 350 mm, 1 x Door 500 mm, incl. 1 Shelf				



Description	Dimensions W x D x H mm	Worktop	Part ref.	Price £
KWBM 40 1570M-4.2	1500 x 700 x 840	Multiplex	110 16 105.03	605.22
KWBL 40 1570M-4.2	1500 x 700 x 840	Linoleum	110 16 192.03	628.22
2 x Drawer 150 mm, 1 x Drawer 200 mm, 1 x Door 500 mm, incl. 1 Shelf				



Description	Dimensions W x D x H mm	Worktop	Part ref.	Price £
KWBM 40 1570M-6.1	1500 x 700 x 840	Multiplex	110 16 107.03	698.67
KWBL 40 1570M-6.1	1500 x 700 x 840	Linoleum	110 16 193.03	775.13
4 x Drawer 75 mm, 2 x Door 350 mm				

Standard paint finish

Housing:	RAL 7035 light grey
Fronts:	RAL 5015 blue .03

Alternative front colours (no extra charge)

RAL 7035 light grey	RAL 7035 light grey	RAL 7035 light grey	RAL 7035 light grey	RAL 7035 light grey
RAL 7035 light grey .16	RAL 7001 grey .01	RAL 6011 green .02	RAL 3001 red .04	RAL 1023 yellow .12

(Please replace the order ref. suffix from .03 to that for your required colour)

Drawer
Cabinets

Workbenches

Workstation
Systems APS

Mobile
Equipment

Storage
Cupboards

Combination Drawer
& Shelving System

Drawer
Dividers

Perfo® System

CNC System

Cases

Modular workbenches KWB

Dimensions: Width 1500 x Depth 700 x Height 840 mm



- Suitable for heavy assembly work
- Load capacity 600-1200 kg depending on worktop version
- Sturdy steel base frame
- Choose from 2 worktop finishes (Thickness 40 mm)
- Modular system that can be expanded as required.
- Load capacity per drawer 100 kg – Normal slide
- Drawer pan internal measurements W 520 x D 520 mm
- Drawer divider systems – see page 210-225
- Central locking mechanism for doors and drawers
- Delivered assembled
- 230 mm floor clearance

Drawer Cabinets

Workbenches

Workstation Systems APS

Mobile Equipment

Storage Cupboards

Combination Drawer & Shelving System

Drawer Dividers

Perfo® System

CNC System

Cases



Description	Dimensions W x D x H mm	Worktop	Part ref.	Price £
KWBM 40 1570M-6.2	1500 x 700 x 840	Multiplex	110 16 109.03	721.19
KWBL 40 1570M-6.2	1500 x 700 x 840	Linoleum	110 16 194.03	797.65
1 x Door 350 mm, incl. 1 Shelf, 1 x Drawer 150 mm 2 x Drawer 75 mm, 1 x Drawer 150 mm, 1 x Drawer 200 mm				



Description	Dimensions W x D x H mm	Worktop	Part ref.	Price £
KWBM 40 1570M-6.3	1500 x 700 x 840	Multiplex	110 11 031.03	693.00
KWBL 40 1570M-6.3	1500 x 700 x 840	Linoleum	110 11 050.03	716.00
4 x Drawer 150 mm, 2 x Drawer 200 mm				



Description	Dimensions W x D x H mm	Worktop	Part ref.	Price £
KWBM 40 1570AM-1.1	1500 x 700 x 840	Multiplex	110 16 091.03	503.68
KWBL 40 1570AM-1.1	1500 x 700 x 840	Linoleum	110 16 195.03	580.15
1 x Door 500 mm				

Standard paint finish

Housing:	RAL 7035 light grey
Fronts:	RAL 5015 blue .03

Alternative front colours (no extra charge)

RAL 7035 light grey	RAL 7035 light grey	RAL 7035 light grey	RAL 7035 light grey	RAL 7035 light grey
RAL 7035 light grey .16	RAL 7001 grey .01	RAL 6011 green .02	RAL 3001 red .04	RAL 1023 yellow .12

(Please replace the order ref. suffix from .03 to that for your required colour)

Modular workbenches KWB

Dimensions: Width 1500 x Depth 700 x Height 840 mm



Description	Dimensions W x D x H mm	Worktop	Part ref.	Price £
KWBM 40 1570AM-2.1	1500 x 700 x 840	Multiplex	110 16 077.03	547.69
KWBL 40 1570AM-2.1	1500 x 700 x 840	Linoleum	110 16 196.03	624.16
1 x Drawer 150 mm, 1 x Door 350 mm				

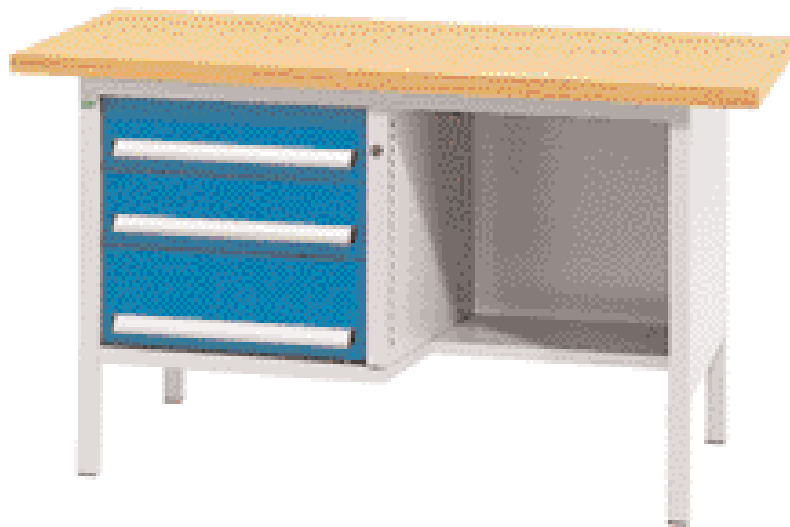

Description	Dimensions W x D x H mm	Worktop	Part ref.	Price £
KWBM 40 1570AM-3.1	1500 x 700 x 840	Multiplex	110 09 041.03	576.94
KWBL 40 1570AM-3.1	1500 x 700 x 840	Linoleum	110 09 073.03	687.04
2 x Drawer 150 mm, 1 x Door 200 mm				



Description	Dimensions W x D x H mm	Worktop	Part ref.	Price £
KWBM 40 1570AM-3.2	1500 x 700 x 840	Multiplex	110 16 087.03	587.68
KWBL 40 1570AM-3.2	1500 x 700 x 840	Linoleum	110 16 207.03	664.15
1 x Door 350 mm, 2 x Drawer 75 mm				

Standard paint finish

Housing:	RAL 7035 light grey
Fronts:	RAL 5015 blue .03

Alternative front colours (no extra charge)

RAL 7035 light grey	RAL 7035 light grey	RAL 7035 light grey	RAL 7035 light grey	RAL 7035 light grey
RAL 7035 light grey .16	RAL 7001 grey .01	RAL 6011 green .02	RAL 3001 red .04	RAL 1023 yellow .12

(Please replace the order ref. suffix from .03 to that for your required colour)

Drawer
Cabinets

Workbenches

Workstation
Systems APS

Mobile
Equipment

Storage
Cupboards

Combination Drawer
& Shelving System

Drawer
Dividers

Perfo® System

CNC System

Cases

Modular workbenches KWB



Dimensions: Width 2000 x Depth 700 x Height 840 mm

- Suitable for heavy assembly work
- Load capacity 600-1200 kg depending on worktop version
- Sturdy steel base frame
- Choose from 2 worktop finishes (Thickness 40 mm)
- Modular system that can be expanded as required.
- Load capacity per drawer 100 kg – Normal slide
- Drawer pan internal measurements W 520 x D 520 mm
- Drawer divider systems – see page 210-225
- Central locking mechanism for doors and drawers
- Delivered assembled
- 230 mm floor clearance

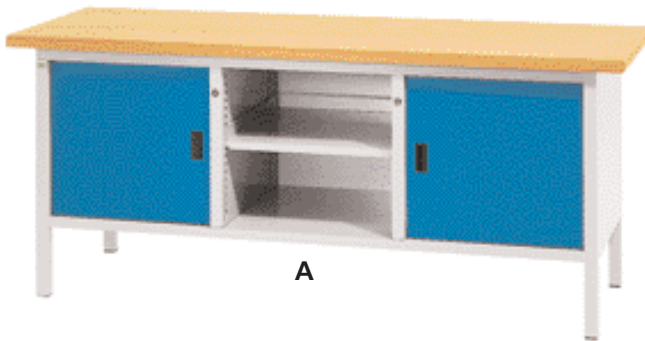

A

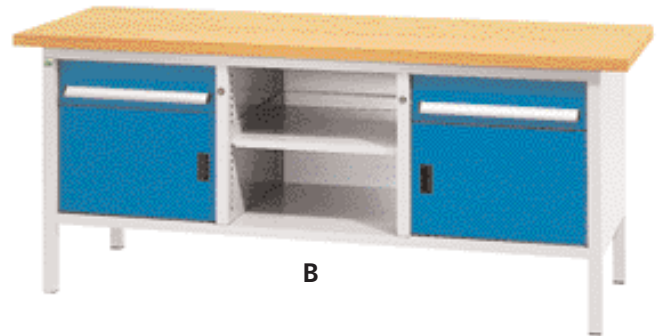

B

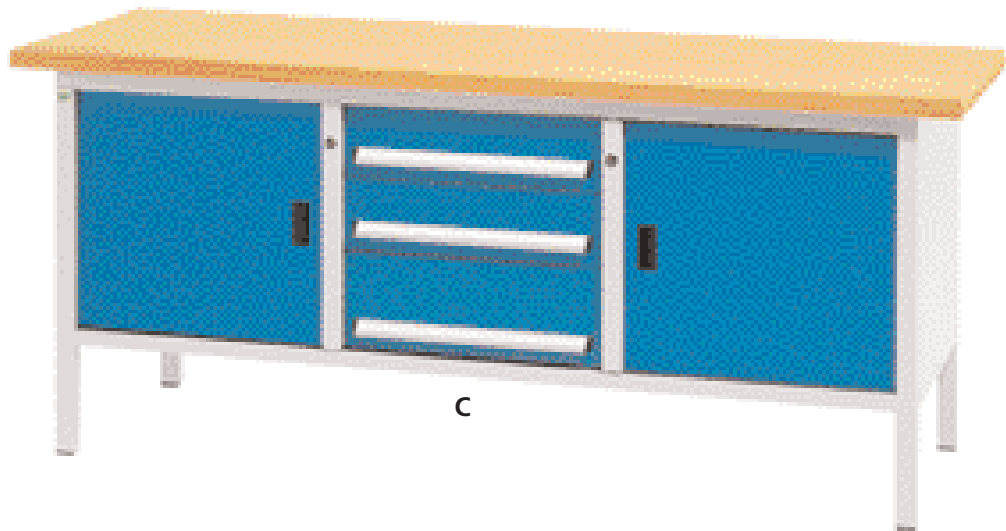

C

Fig.	Description	Dimensions W x D x H mm	Worktop	Part ref.	Price £
A	KWBM 40 2070M-2.1	2000 x 700 x 840	Multiplex	110 16 111.03	671.35
	KWBL 40 2070M-2.1	2000 x 700 x 840	Linoleum	110 16 197.03	688.00
2 x Door 500 mm, incl. 3 Shelves					
B	KWBM 40 2070M-4.2	2000 x 700 x 840	Multiplex	110 16 113.03	723.07
	KWBL 40 2070M-4.2	2000 x 700 x 840	Linoleum	110 16 198.03	803.38
2 x Door 350 mm, 2 x Drawer 150 mm, incl. 1 Shelf					
C	KWBM 40 2070M-5.1	2000 x 700 x 840	Multiplex	110 16 117.03	795.84
	KWBL 40 2070M-5.1	2000 x 700 x 840	Linoleum	110 16 200.03	812.84
2 x Door 500 mm, incl. 2 Shelves, 2 x Drawer 150 mm, 1 x Drawer 200 mm					

Standard paint finish

Housing:	RAL 7035 light grey
Fronts:	RAL 5015 blue .03

Alternative front colours (no extra charge)

RAL 7035 light grey	RAL 7035 light grey	RAL 7035 light grey	RAL 7035 light grey	RAL 7035 light grey
RAL 7035 light grey .16	RAL 7001 grey .01	RAL 6011 green .02	RAL 3001 red .04	RAL 1023 yellow .12

(Please replace the order ref. suffix from .03 to that for your required colour)

Modular workbenches KWB

Dimensions: Width 2000 x Depth 700 x Height 840 mm

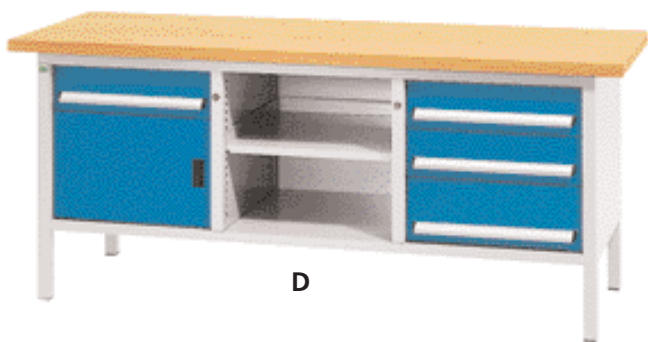

D

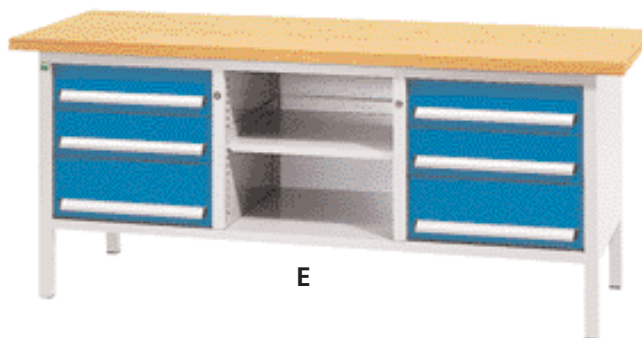

E

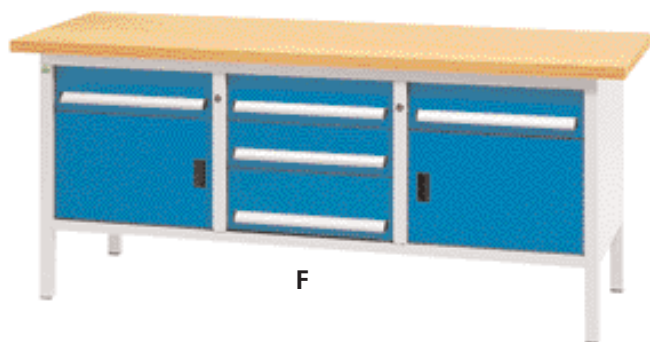

F

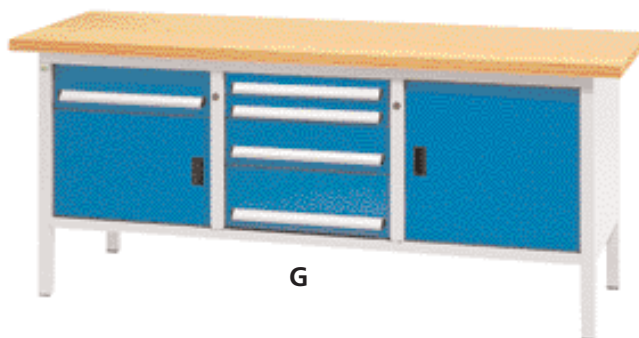

G

Fig.	Description	Dimensions W x D x H mm	Worktop	Part ref.	Price £
D	KWBM 40 2070M-5.3	2000 x 700 x 840	Multiplex	110 16 115.03	784.54
	KWBL 40 2070M-5.3	2000 x 700 x 840	Linoleum	110 16 199.03	864.82
1 x Door 350 mm, 3 x Drawer 150 mm, 1 x Drawer 200 mm, incl. 1 Shelf					
E	KWBM 40 2070M-6.1	2000 x 700 x 840	Multiplex	110 11 033.03	848.79
	KWBL 40 2070M-6.1	2000 x 700 x 840	Linoleum	110 11 051.03	929.08
4 x Drawer 150 mm, 2 x Drawer 200 mm, incl. 1 Shelf					
F	KWBM 40 2070M-7.1	2000 x 700 x 840	Multiplex	110 16 119.03	847.59
	KWBL 40 2070M-7.1	2000 x 700 x 840	Linoleum	110 16 201.03	864.59
2 x Door 350 mm, 4 x Drawer 150 mm, 1 x Drawer 200 mm					
G	KWBM 40 2070M-7.2	2000 x 700 x 840	Multiplex	110 16 121.03	861.67
	KWBL 40 2070M-7.2	2000 x 700 x 840	Linoleum	110 16 202.03	941.96
1 x Door 350 mm, 1 x Door 500 mm, 2 x Drawer 75 mm, 2 x Drawer 150 mm, 1 x Drawer 200 mm, incl. 1 Shelf					

Standard paint finish

Housing:	RAL 7035 light grey
Fronts:	RAL 5015 blue .03

Alternative front colours (no extra charge)

RAL 7035 light grey	RAL 7035 light grey	RAL 7035 light grey	RAL 7035 light grey	RAL 7035 light grey
RAL 7035 light grey .16	RAL 7001 grey .01	RAL 6011 green .02	RAL 3001 red .04	RAL 1023 yellow .12

(Please replace the order ref. suffix from .03 to that for your required colour)

Drawer Cabinets

Workbenches

Workstation Systems APS

Mobile Equipment

Storage Cupboards

Combination Drawer & Shelving System

Drawer Dividers

Perfo® System

CNC System

Cases

Modular workbenches KWB



Dimensions: Width 2000 x Depth 700 x Height 840 mm

- Suitable for heavy assembly work
- Load capacity 600-1200 kg depending on worktop version
- Sturdy steel base frame
- Choose from 2 worktop finishes (Thickness 40 mm)
- Modular system that can be expanded as required.
- Load capacity per drawer 100 kg – Normal slide
- Drawer pan internal measurements W 520 x D 520 mm
- Drawer divider systems see page 210-225
- Central locking mechanism for doors and drawers
- Delivered assembled
- 230 mm floor clearance
- Recessed base frame for extra legroom

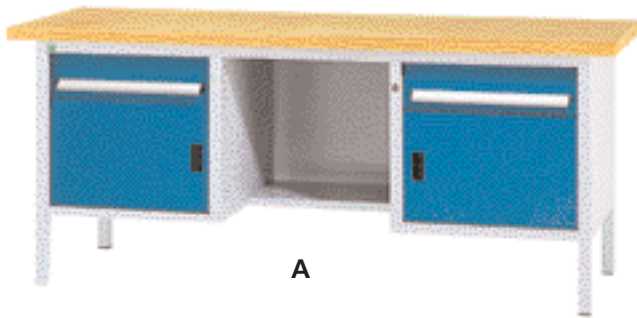

A

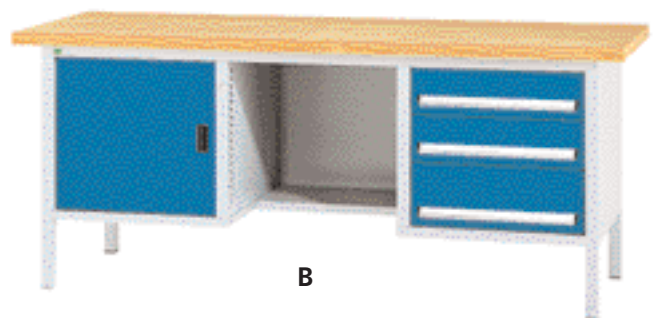

B

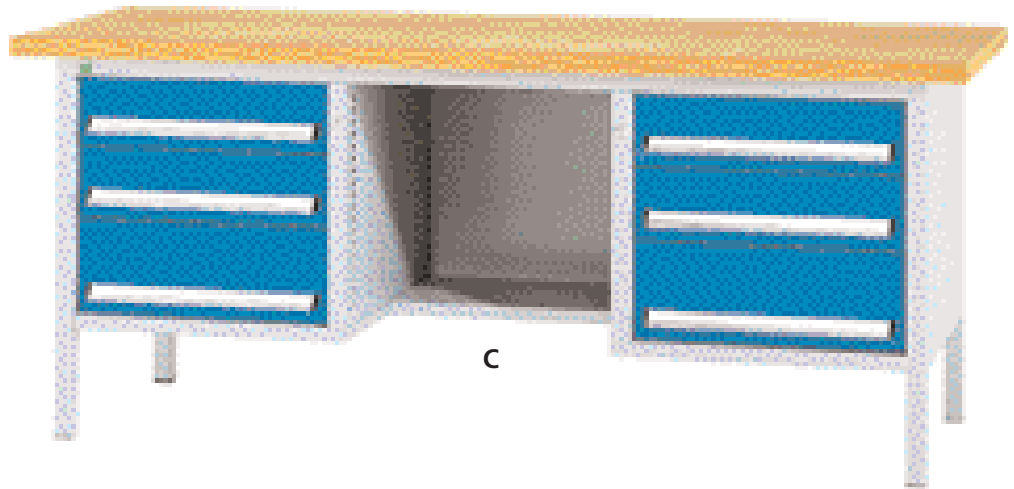

C

Fig.	Description	Dimensions W x D x H mm	Worktop	Part ref.	Price £
A	KWBM 40 2070AM-4.1	2000 x 700 x 840	Multiplex	110 16 125.03	728.62
	KWBL 40 2070AM-4.1	2000 x 700 x 840	Linoleum	110 16 203.03	745.62
2 x Door 350 mm, 2 x Drawer 150 mm					
B	KWBM 40 2070AM-4.3	2000 x 700 x 840	Multiplex	110 16 127.03	765.56
	KWBL 40 2070AM-4.3	2000 x 700 x 840	Linoleum	110 16 204.03	782.56
1 x Door 500 mm, incl. 1 Shelf, 2 x Drawer 150 mm, 1 x Drawer 200 mm					
C	KWBM 40 2070AM-6.1	2000 x 700 x 840	Multiplex	110 11 035.03	854.32
	KWBL 40 2070AM-6.1	2000 x 700 x 840	Linoleum	110 11 052.03	871.32
4 x Drawer 150 mm, 2 x Drawer 200 mm					

Standard paint finish

Housing:	RAL 7035 light grey
Fronts:	RAL 5015 blue .03

Alternative front colours (no extra charge)

RAL 7035 light grey	RAL 7035 light grey	RAL 7035 light grey	RAL 7035 light grey	RAL 7035 light grey
RAL 7035 light grey .16	RAL 7001 grey .01	RAL 6011 green .02	RAL 3001 red .04	RAL 1023 yellow .12

(Please replace the order ref. suffix from .03 to that for your required colour)

Modular workbenches KWB

Dimensions: Width 2000 x Depth 700 x Height 840 mm

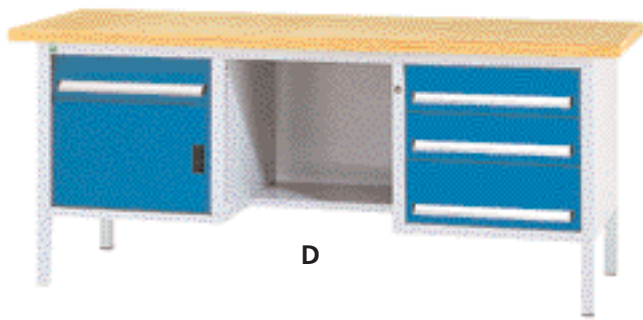

D

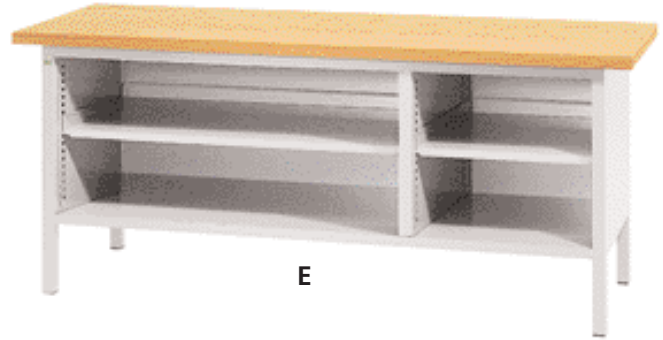

E

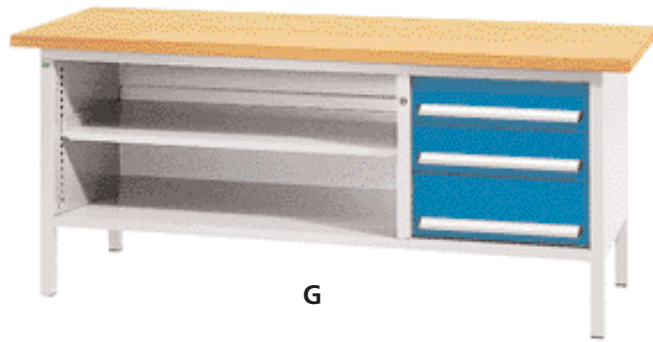

G

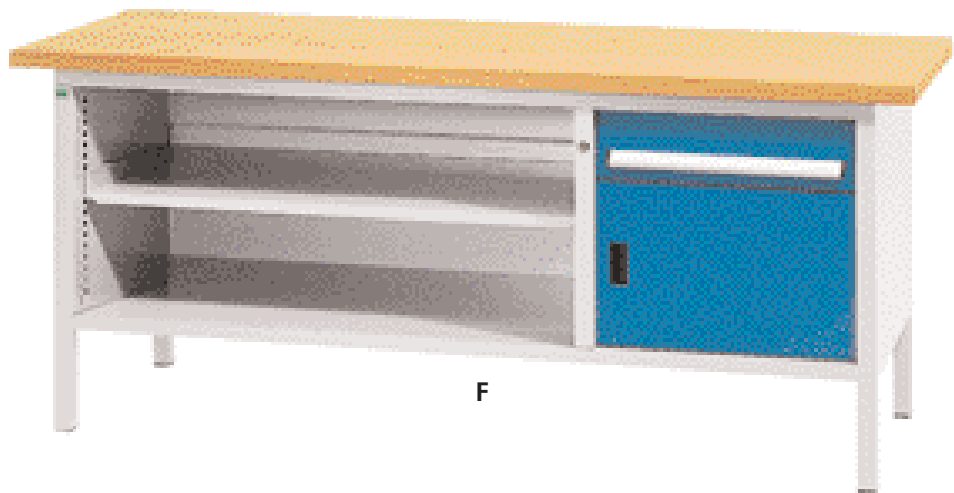

F

Drawer
Cabinets

Workbenches

Workstation
Systems APS

Mobile
Equipment

Storage
Cupboards

Combination Drawer
& Shelving System

Drawer
Dividers

Perfo® System

CNC System

Cases

Fig.	Description	Dimensions W x D x H mm	Worktop	Part ref.	Price £
D	KWB 40 2070AM-5.1	2000 x 700 x 840	Multiplex	110 16 129.03	808.45
			Linoleum	110 16 205.03	888.74
1 x Door 350 mm, 3 x Drawer 150 mm, 1 x Drawer 200 mm					
E	KWB 40 2070DM-0.1	2000 x 700 x 840	Multiplex	110 03 073.16	589.04
			Linoleum	110 03 086.16	669.32
incl. 1 Shelf long, incl. 1 Shelf short					
F	KWB 40 2070DM-2.1	2000 x 700 x 840	Multiplex	110 16 086.03	650.89
			Linoleum	110 16 206.03	667.89
1 x Door 350 mm, 1 x Drawer 150 mm, incl. 1 Shelf long					
G	KWB 40 2070DM-3.1	2000 x 700 x 840	Multiplex	110 09 067.03	713.51
			Linoleum	110 09 074.03	793.80
2 x Drawer 150 mm, 1 x Drawer 200 mm, incl. 1 Shelf long					

Standard paint finish

Housing:	RAL 7035 light grey
Fronts:	RAL 5015 blue .03

Alternative front colours (no extra charge)

RAL 7035 light grey	RAL 7035 light grey	RAL 7035 light grey	RAL 7035 light grey	RAL 7035 light grey
RAL 6011 green .02	RAL 3001 red .04	RAL 1023 yellow .12		

(Please replace the order ref. suffix from .03 to that for your required colour)



Base frame 0770



Layout possibility



Base frame 1570



Layout possibility



Base frame 1570A



Layout possibility



Base frame 1570AL

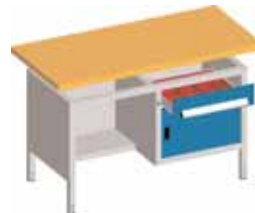

Layout possibility

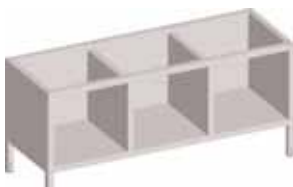

Base frame 2070



Layout possibility



Base frame 2070A

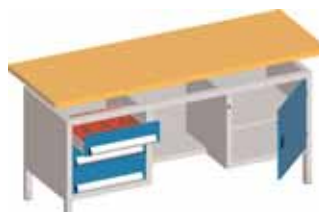

Layout possibility

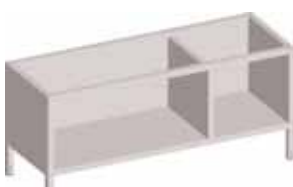

Base frame 2070D

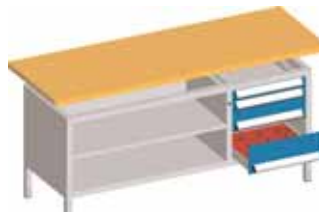

Layout possibility

Description:

The single worktable components can be combined to form your own custom bench.

Modular workbenches are supplied fully assembled

Following individual components are available:

• **Worktops**

9 different worktop types
in 3 different thicknesses

• **Base frame**

Basic KWB frames include 1, 2 or 3 modules with a usable height of 500 mm each. Central locking mechanisms can be specified with the following components. Basic frames 1570A, 1570AL and 2070A have a half depth shelf on the right hand, left hand or central position to provide a knee-hole.

• **Individual drawers available in six different front heights**

Ball-bearing drawers with aluminium handles including paper strips and transparent cover for drawer labelling. Internal dimensions W 520 x D 520 mm
NS-Normal slide
- Load capacity: 100 kg
- Slide: 93%

• **Cabinet doors in 2 heights**

With integral handle
(not to be used for the middle block)

• **Shelf**

With 3-sided safety lip.
Adjustable in 25 mm increments

• **Height adjustment**

All versions can be specified with a height adjustment kit.

• **Mobile version**

All versions can be specified with a mobility kit.

Description	Delivery	Usable height mm	Dimensions W x D x H mm	Part ref.	Price £
Base frame 0770	assembled ¹	1 x 500	675 x 635 x 800	119 03 153.16	314.69
Base frame 1570	assembled ¹	2 x 500	1225 x 635 x 800	119 03 097.16	331.37
Base frame 1570A	assembled ¹	2 x 500	1225 x 635 x 800	119 03 120.16	339.21
Base frame 1570AL	assembled ¹	2 x 500	1225 x 635 x 800	119 03 174.16	316.10
Base frame 2070 ²	assembled ¹	3 x 500	1825 x 635 x 800	119 03 098.16	387.75
Base frame 2070A ²	assembled ¹	3 x 500	1825 x 635 x 800	119 03 099.16	410.49
Base frame 2070D	assembled ¹	1 x 500	1825 x 635 x 800	119 03 118.16	377.00

¹ Please always specify on your order how the drawers should be arranged from top to bottom.

² Please note: The base frame 2070 and 2070A cannot be fitted with cabinet doors in the centre module.

Description	Dimensions W x D x H mm	Part ref.	Price £
Worktop Beech multiplex, 40 mm	750 x 700 x 40	112 01 266.08	52.75
Worktop Beech multiplex, 40 mm	1500 x 700 x 40	112 01 003.08	101.00
Worktop Beech multiplex, 40 mm	2000 x 700 x 40	112 01 006.08	139.00
Worktop Linoleum, 40 mm	750 x 700 x 40	112 01 266.15	103.23
Worktop Linoleum, 40 mm	1500 x 700 x 40	112 01 003.15	124.00
Worktop Linoleum, 40 mm	2000 x 700 x 40	112 01 006.15	156.00

further worktops – see page 100-104

Description	Front height mm	Dimensions internal W x D mm	Part ref.	Price £
Single drawer ¹	75	520 x 520	105 05 112.03	41.03
Single drawer ¹	100	520 x 520	105 05 113.03	43.98
Single drawer ¹	125	520 x 520	105 05 114.03	44.37
Single drawer ¹	150	520 x 520	105 05 115.03	44.69
Single drawer ¹	175	520 x 520	105 05 116.03	45.94
Single drawer ¹	200	520 x 520	105 05 117.03	46.89
Hinged doors ^{1,2}	350		125 01 153.03	23.79
Hinged doors ^{1,2}	500		125 01 154.03	25.28
Shelf	50	555 x 590 x 50	121 01 161.16	15.44
Basic rack shelf 2070 D	50	1150 x 590 x 50	121 03 030.16	31.10

¹ Please note that the combined sum of the front heights may not exceed the usable height of the individual blocks.

² Please note: the centre module in base frames 2070 and 2070A cannot be fitted with cabinet doors.

Drawer dividers – see page 210-225.

KWB accessories



»Height adjustment kit« (cannot be used in combination with the mobility kit)
 (4 pieces), adjustable area 0-150 mm in 50 mm increments or infinitely variable
 Height adjustable from 800 to 950 mm (without panel).
 Retrofit kit can be used to adjust bench to uneven floor conditions.

Part ref.	Price £
080 30 462.16	23.13



»Mobility kit« (cannot be used in combination with the height adjustment kit)
 (4 pieces), 4 Swivel castors Ø 100 mm, 2 castors having locking brakes. Height 120 mm

Part ref.	Price £
809 06 008	64.02

Standard paint finish

Housing:	RAL 7035 light grey
Fronts:	RAL 5015 blue .03

Alternative front colours (no extra charge)

RAL 7035 light grey	RAL 7035 light grey	RAL 7035 light grey	RAL 7035 light grey	RAL 7035 light grey
RAL 7035 light grey .16	RAL 7001 grey .01	RAL 6011 green .02	RAL 3001 red .04	RAL 1023 yellow .12

(Please replace the order ref. suffix from .03 to that for your required colour)

Drawer Cabinets

Workbenches

Workstation Systems APS

Mobile Equipment

Storage Cupboards

Combination Drawer & Shelving System

Drawer Dividers

Perfo® System

CNC System

Cases

Beech multiplex worktop

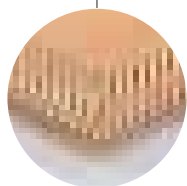
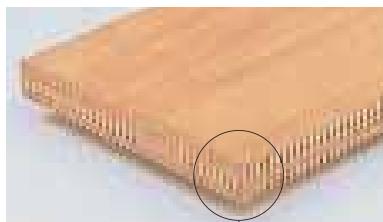

Max. dimensions: 2500 x 1500 mm*

Special size*	Part ref.	Price
Thickness 30 mm	112 01 066.08	97.61 £/m ²
Thickness 40 mm	112 01 049.08	205.75 £/m ²
Thickness 50 mm	112 01 048.08	134.33 £/m ²

Material: Laminated bi-directionally bonded beech veneer
 Top surface: Oiled
 Bottom side: Oiled
 Colour: Natural beech
 Bonding: IW 67
 Quality: II / III according to DIN 68705 Part 2

Dimensions W x D x H mm	Part ref.	Price £
1500 x 700 x 30	112 01 114.08	96.00
2000 x 700 x 30	112 01 118.08	133.00
750 x 700 x 40	112 01 266.08	52.75
1500 x 700 x 40	112 01 003.08	101.00
2000 x 700 x 40	112 01 006.08	139.00
1500 x 700 x 50	112 01 002.08	139.26
2000 x 700 x 50	112 01 005.08	200.47
1500 x 900 x 30	112 01 082.08	101.00
2000 x 900 x 30	112 01 083.08	139.00
1500 x 900 x 40	112 01 148.08	122.00
2000 x 900 x 40	112 01 149.08	167.00

Beech worktop

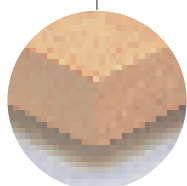
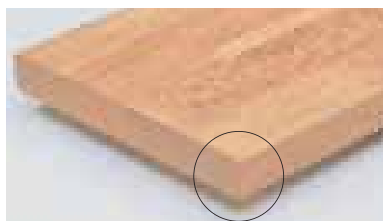

Max. dimensions: 3000 x 1200 mm*

Special size*	Part ref.	Price
Thickness 30 mm	112 01 066.07	153.45 £/m ²
Thickness 40 mm	112 01 049.07	156.20 £/m ²
Thickness 50 mm	112 01 048.07	190.03 £/m ²

Material: Solid beech, spliced joints
 Top surface: 2 x DD painted
 Bottom side: 1 x DD painted
 Colour: Natural beech
 Data: Abrasion and acid resistant surface, spliced joints, with a high load bearing capacity

Dimensions W x D x H mm	Part ref.	Price £
1500 x 700 x 30	112 01 114.07	148.94
2000 x 700 x 30	112 01 118.07	183.19
750 x 700 x 40	112 01 266.07	71.91
1500 x 700 x 40	112 01 003.07	141.27
2000 x 700 x 40	112 01 006.07	183.19
1500 x 700 x 50	112 01 002.07	188.47
2000 x 700 x 50	112 01 005.07	260.87
1500 x 900 x 30	112 01 082.07	206.01
2000 x 900 x 30	112 01 083.07	272.67
1500 x 900 x 40	112 01 148.07	268.54
2000 x 900 x 40	112 01 149.07	343.64

Universal worktop

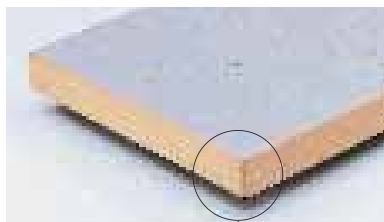

Max. dimensions: 3000 x 1200 mm*

Special size*	Part ref.	Price
Thickness 30 mm	112 01 066.13	156.40 £/m ²
Thickness 40 mm	112 01 049.13	203.60 £/m ²
Thickness 50 mm	112 01 048.13	189.24 £/m ²

Material: 30 mm thick with chipboard core, 40 mm thick with hardwood core

Top surface: Linoleum 2mm (antistatic)

Bottom side: HPL laminate surface layer

Edges: 3 mm thick solid beech edges with rounded radius R3

Colour: Light grey

Data: Linoleum laminate in accordance with EN 548, permanently antistatic, virtually inflammable (B1) in accordance with DIN 4102, hard wearing and resistant to temperature, resistant to oil, grease and tar, partially resistant to weak acids and solvents, biodegradable

Insert: For work with high abrasion levels resistant to weak acids and alkalis

Dimensions W x D x H mm	Part ref.	Price £
1500 x 700 x 30	112 01 114.13	169.20
2000 x 700 x 30	112 01 118.13	194.79
750 x 700 x 40	112 01 266.13	105.73
1500 x 700 x 40	112 01 003.13	193.78
2000 x 700 x 40	112 01 006.13	228.03
1500 x 700 x 50	112 01 002.13	204.60
2000 x 700 x 50	112 01 005.13	243.96
1500 x 900 x 30	112 01 082.13	285.31
2000 x 900 x 30	112 01 083.13	332.15
1500 x 900 x 40	112 01 148.13	300.73
2000 x 900 x 40	112 01 149.13	351.98

Linoleum worktop

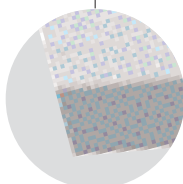
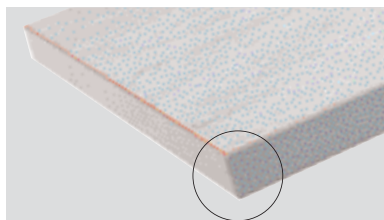

Material: 30/40 mm thick with chipboard core

Top surface: Linoleum

Edges: Plastic edging

Colour: Grey

Data: Resistant to oil and grease

Dimensions W x D x H mm	Part ref.	Price £
1500 x 700 x 30	112 01 114.15	117.00
2000 x 700 x 30	112 01 118.15	143.00
750 x 700 x 40	112 01 266.15	103.23
1500 x 700 x 40	112 01 003.15	124.00
2000 x 700 x 40	112 01 006.15	156.00
1500 x 900 x 30	112 01 082.15	125.00
2000 x 900 x 30	112 01 083.15	187.00
1500 x 900 x 40	112 01 148.15	132.00
2000 x 900 x 40	112 01 149.15	196.00

Accessories

only available in combination with custom made worktops



'U' profile steel edge protection (front)
Protects worktop edge in harsh applications.
Part ref.: 080 03 245
Price: 26.95 £ (per metre)



Worktop-worktop connector
For invisible worktop joints in multi bench configurations
Part ref.: 126 35 003
Price: 19.67 £ (per item)
(Illustration shows two pieces)

* Special size for special packaging:
Please note that additional/special packaging is required for special sizes, width >2000 mm, depth >800 mm
Part ref.: 820 02 009 Price: 34.12 £

Drawer Cabinets

Workbenches

Workstation Systems APS

Mobile Equipment

Storage Cupboards

Combination Drawer & Shelving System

Drawer Dividers

Perfo® System

CNC System

Cases

Arphenol worktop

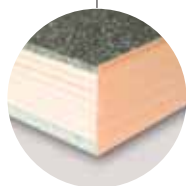
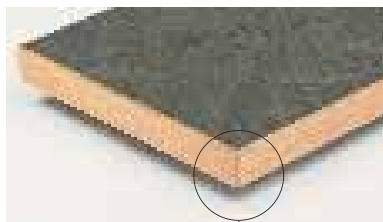

Max. dimensions: 2500 x 1200 mm*

Special size*	Part ref.	Price
Thickness 30 mm	112 01 066.10	183.93 £/m ² *
Thickness 40 mm	112 01 049.10	190.74 £/m ² *
Thickness 50 mm	112 01 048.10	318.46 £/m ² *

* Dimensions < 0.5m² by special request

Material: Hardwood core with 4mm Arphenol surface and laminate hardwood edging.
 Top surface: Painted (UV lacquer)
 Bottom side: 6 mm chipboard surface layer
 Colour: Grey brown
 Data: Surface resistant to chemicals in accordance with DIN 68 861-18.

Dimensions W x D x H mm	Part ref.	Price £
1500 x 700 x 30	112 01 114.10	202.39
2000 x 700 x 30	112 01 118.10	269.92
750 x 700 x 40	112 01 266.10	121.92
1500 x 700 x 40	112 01 003.10	183.85
2000 x 700 x 40	112 01 006.10	238.55
1500 x 700 x 50	112 01 002.10	186.70
2000 x 700 x 50	112 01 005.10	242.19
1500 x 900 x 30	112 01 082.10	291.92
2000 x 900 x 30	112 01 083.10	393.83
1500 x 900 x 40	112 01 148.10	297.43
2000 x 900 x 40	112 01 149.10	401.54

Hard laminate ESD safe worktop for electrostatically sensitive components

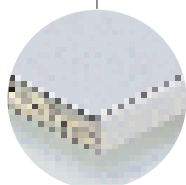
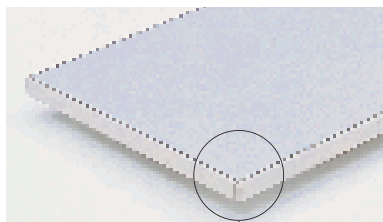

Max. dimensions: 3000 x 1200 mm*

Special size*	Part ref.	Price
Thickness 30 mm	112 01 066.05	235.07 £/m ²
Thickness 40 mm	112 01 049.05	255.33 £/m ²
Thickness 50 mm	112 01 048.05	288.53 £/m ²

Material: Conductive chipboard
 Top surface: Conductive HPL laminated surface 0.8 mm
 Bottom side: HPL laminate surface layer
 Edges: 3 mm thick ABS edges, antistatic, rounded radius R3
 Colour: Light grey
 Data: HPL laminate surface in accordance with DIN EN 438, maximum abrasion resistance, maximum impact and scratch resistance, resistant to boiling water and household chemicals, solvents, weak acids and alkalis
 Leakage values: In accordance with DIN EN 100 015 and EN 61340

Dimensions W x D x H mm	Part ref.	Price £
1500 x 700 x 30	112 01 114.05	197.19
2000 x 700 x 30	112 01 118.05	215.68
750 x 700 x 40	112 01 266.05	129.93
1500 x 700 x 40	112 01 003.05	229.64
2000 x 700 x 40	112 01 006.05	282.90
1500 x 700 x 50	112 01 002.05	301.95
2000 x 700 x 50	112 01 005.05	346.82
1500 x 900 x 30	112 01 082.05	291.92
2000 x 900 x 30	112 01 083.05	358.58
1500 x 900 x 40	112 01 148.05	318.36
2000 x 900 x 40	112 01 149.05	389.42

Worktop with zinc-finished steel cladding

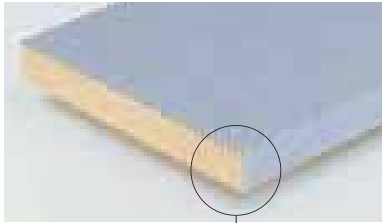

Material:
Top surface:
Bottom side:
Edges:

Chipboard
Zinc coated sheet steel 2 mm
HPL laminate surface layer
Veneered edge
Front edge: sheet steel 'U' profile edging
Rear edge: sheet steel 'L' profile edging

Available thicknesses:
Colour:
Data:

Zinc plated
Sheet steel, hot-dip galvanized, in accordance with EN 10142, tested to EN 10204

Max. dimensions: 3000 x 1200 mm*

Special size*	Part ref.	Price
Thickness 30 mm	112 01 066.14	248.84 £/m ²
Thickness 40 mm	112 01 049.14	248.84 £/m ²
Thickness 50 mm	112 01 048.14	254.74 £/m ²

Dimensions W x D x H mm	Part ref.	Price £
1500 x 700 x 30	112 01 114.14	230.17
2000 x 700 x 30	112 01 118.14	297.06
750 x 700 x 40	112 01 266.14	119.78
1500 x 700 x 40	112 01 003.14	230.17
2000 x 700 x 40	112 01 006.14	297.06
1500 x 700 x 50	112 01 002.14	240.00
2000 x 700 x 50	112 01 005.14	310.83
1500 x 900 x 30	112 01 082.14	397.80
2000 x 900 x 30	112 01 083.14	362.99
1500 x 900 x 40	112 01 148.14	397.80
2000 x 900 x 40	112 01 149.14	362.99

Accessories only available in combination with custom made worktops



'U' profile steel edge protection (front)

Protects worktop edge in harsh applications.
Part ref.: 080 03 245
Price: 26.95 £ (per metre)



Worktop-worktop connector

For invisible worktop joints in multi bench configurations
Part ref.: 126 35 003
Price: 19.67 £ (per item)
(Illustration shows two pieces)

* Special size for special packaging:

Please note that additional/special packaging is required for special sizes, width >2000 mm, depth >800 mm
Part ref.: 820 02 009 Price: 34.12 £



Drawer
Cabinets

Workbenches

Workstation
Systems APS

Mobile
Equipment

Storage
Cupboards

Combination Drawer
& Shelving System

Drawer
Dividers

Perfo® System

CNC System

Cases

Fig.	Description	Worktop	Part ref.	Price £
A	Corner worktop – Type »L«	Multiplex	112 04 031.08	112.21
B	Corner worktop – Type »L«	Linoleum	112 04 031.15	222.00
C	Corner worktop – Type »T«	Multiplex	112 04 032.08	168.36
D	Corner worktop – Type »T«	Linoleum	112 04 032.15	320.56
E	Wall support bracket 500 x 75 mm		112 04 025.16	7.25
F	Wall support bracket 750 x 75 mm		112 04 026.16	10.25
G	Worktop joining plate – 250 x 100 mm		112 04 021.16	3.95
H	Worktop joining plate – 250 x 200 mm		112 04 022.16	6.45
I	Worktop joining plate – 500 x 100 mm		112 04 023.16	6.45
J	Worktop joining plate – 500 x 200 mm		112 04 024.16	11.40

Material thickness: 40 mm

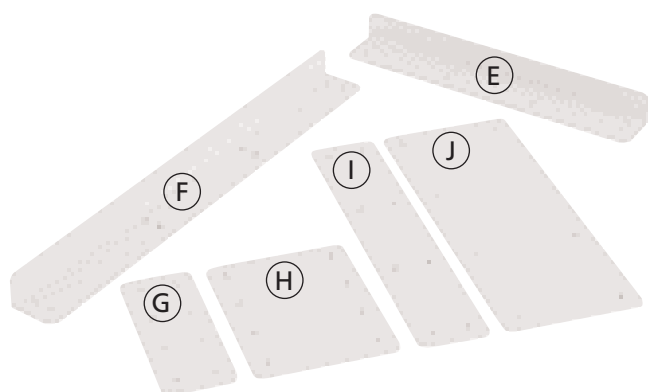
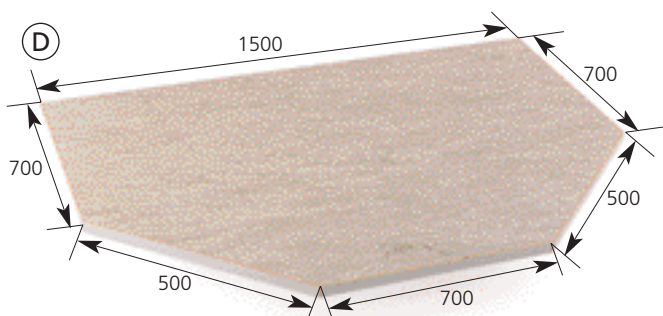
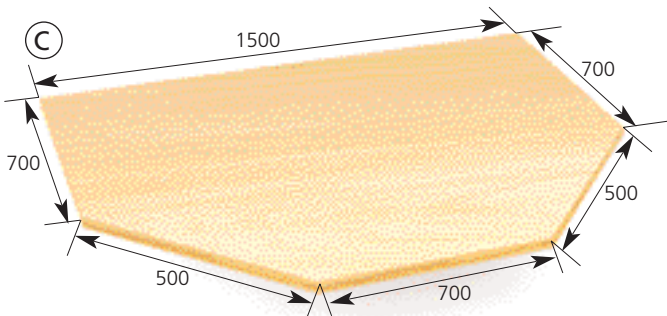
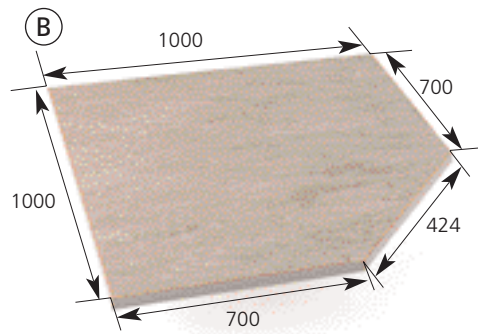
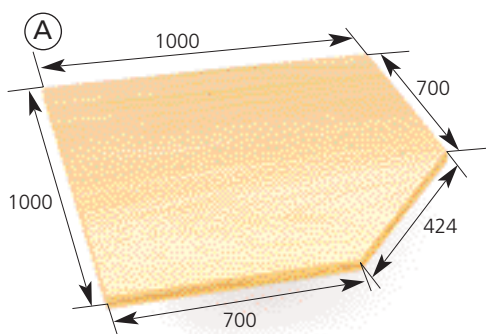

Beech multiplex worktop upstand

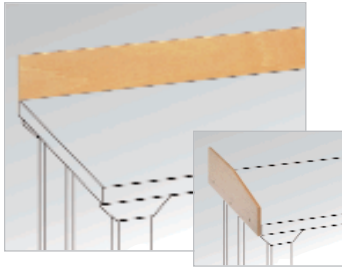

Description	Dimensions W x D x H mm	Part ref.	Price £
rear	750 x 15 x 150	112 03 052	22.24
rear	1500 x 15 x 150	112 03 001	30.58
rear	2000 x 15 x 150	112 03 002	36.04
Side	15 x 700 x 150	112 03 003	23.18
Side	15 x 900 x 150	112 03 056	23.18

Metal worktop upstand set



for workbenches – Width 1500 / 2000 x Depth 700 mm

Description	Dimensions W x H mm	Part ref.	Price £
Worktop upstand set	1500 x 100	119 03 108.16	35.00
Worktop upstand set	2000 x 100	119 03 109.16	47.20

Adjustable shelf

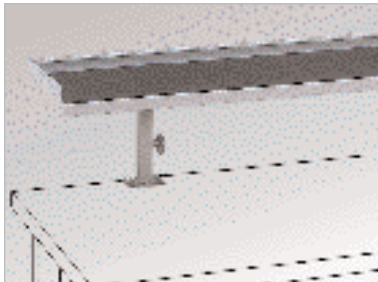

Height adjustable, with ribbed rubber mat

for worktable Width mm	Dimensions W x D x H mm	Part ref.	Price £
1500	1500 x 300 x 230-345	121 15 003.16	113.28
2000	2000 x 300 x 230-345	121 15 004.16	130.80

Drawer
Cabinets

Workbenches

Workstation
Systems APS

Mobile
Equipment

Storage
Cupboards

Combination Drawer
& Shelving System

Drawer
Dividers

Perfo® System

CNC System

Cases

Perfo® back panel

Height 457 mm, also suitable for wall mounting

(Accessories for perforated panels – see page 232-239, Accessories for louvred panels – see page 253 and 270)

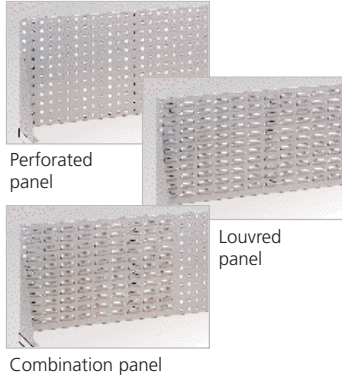

Description	Dimensions W x H mm	Part ref.	Price £
Perfo® perforated panel ¹⁾	1486 x 457	140 25 118.16	45.27
Perfo® perforated panel ¹⁾	1981 x 457	140 25 119.16	57.68
Perfo® louvred panel ¹⁾	1486 x 457	140 25 140.16	45.27
Perfo® louvred panel ¹⁾	1981 x 457	140 25 141.16	57.68
Perfo® combination panel ¹⁾	1486 x 457	140 25 156.16	45.27
Perfo® combination panel ¹⁾	1981 x 457	140 25 157.16	57.68

¹⁾ Please order wing plates and brackets separately for fixing to workbenches.

Perfo® - Wing plates for workbench mounting

for mounting the Perfo® back panel to a workbench

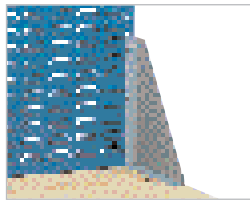

	Part ref.	Price £
1 pair	080 10 067.16	15.02

Perfo® - Bracket for workbench mounting

For mounting the Perfo® back panel to a workbench.

The following quantity of brackets will be required: W 1486 mm = 4 piece, W 1981 = 5 piece



	Part ref.	Price £
for the mounting of single panels	080 30 050	2.91
for the mounting of 2 panels one above another	080 30 048	5.86



Power duct

Connecting cable with plug / On / Off Switch

Version	Main switch	Dimensions W x D x H mm	Quantity plug	Part ref.	Price £
EU	No	300 x 45 x 60	3	510 01 024	54.38
EU	No	450 x 45 x 60	6	510 01 025	68.52
EU	Yes	400 x 45 x 60	3	510 01 026	145.11
EU	Yes	550 x 45 x 60	6	510 01 027	161.83
UK	No	300 x 45 x 60	3	510 01 045	65.38
UK	No	450 x 45 x 60	6	510 01 046	90.45
UK	Yes	400 x 45 x 60	3	510 01 047	144.58
UK	Yes	550 x 45 x 60	6	510 01 048	166.76

***For information on country-specific versions for other countries, please consult your local bott partner.**

Perfo® back panels

incl. workbench wing plates and brackets

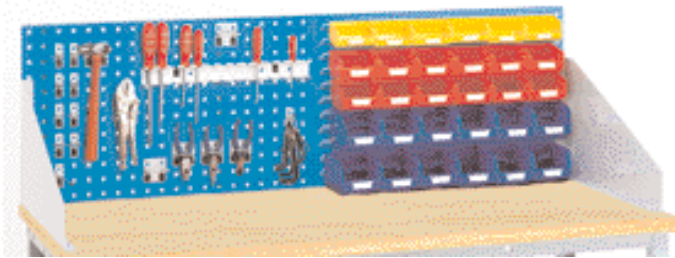

Description	for workbench with width	Part ref.	Price £
Perfo® back panel – with perforated panel	1500 mm	070 02 043.03	50.00
Perfo® back panel – with perforated panel	2000 mm	070 02 044.03	65.00
Perfo® back panel – with louvred panel	1500 mm	070 02 045.03	50.00
Perfo® back panel – with louvred panel	2000 mm	070 02 046.03	65.00
Perfo® back panel – with combination panel	1500 mm	070 02 054.03	50.00
Perfo® back panel – with combination panel	2000 mm	070 02 055.03	65.00

Description	for Perfo® panel	Part ref.	Price £
Perfo® hook assortment – 10 pieces	1500 mm Combination panel	140 31 410	7.50
Perfo® hook assortment – 15 pieces	1500 mm Perforated panel / 2000 mm Combination panel	140 31 411	28.75
Perfo® hook assortment – 20 pieces	2000 mm Perforated panel	140 31 412	33.00
Perfo® plastic bins – 30 pieces	1500 mm Combination panel	130 31 106	28.80
Perfo® plastic bins – 45 pieces	2000 mm Combination panel	130 31 092	43.20
Perfo® plastic bins – 60 pieces	1500 mm Louvred panel	130 31 167	57.60
Perfo® plastic bins – 90 pieces	2000 mm Louvred panel	130 31 105	95.40

Standard paint finish

Housing:	RAL 7035 light grey
Fronts:	RAL 5015 blue .03

Alternative front colours (no extra charge)

RAL 7035 light grey	RAL 7035 light grey	RAL 7035 light grey	RAL 7035 light grey	RAL 7035 light grey
RAL 7035 light grey .16	RAL 7001 grey .01	RAL 6011 green .02	RAL 3001 red .04	RAL 1023 yellow .12

(Please replace the order ref. suffix from .03 to that for your required colour)

Drawer
Cabinets

Workbenches

Workstation
Systems APS

Mobile
Equipment

Storage
Cupboards

Combination Drawer
& Shelving System

Drawer
Dividers

Perfo® System

CNC System

Cases



Rear mounting frame

For mounting all APS® parts (Page 126-137)
Double sided usage. Fits to the worktop.

System size	Dimensions W x D x H mm	Usable height mm	Part ref.	Price £
815	855 x 70 x 1035	1000	120 15 010	86.29
1000	1040 x 70 x 1035	1000	120 15 011	88.06
1235	1275 x 70 x 1035	1000	120 15 012	89.44
Fixing kit			900 99 123	6.41

for worktop thickness < 40 mm as well as chipboard core worktops



Power supply (EU version)

Electrical accessories are also suitable for hexagonal services units and workbench leg F3.
Please include an installation sketch with your order. Further installation components available on request.

***For information on country-specific versions for other countries, please consult your local bott partner.**



Power duct

Delivered pre-wired
PVC duct allows individual configuration of power accessories, H 130 x D 70 mm
L 1500 Part ref. 510 01 001 Price: £ 149.85
L 2000 Part ref. 510 01 002 Price: £ 151.30

Connection cable 4 m

220 V Part ref. 508 10 008 Price: £ 54.34
380 V Part ref. 508 10 009 Price: £ 74.31

Connection hose Pneumatic 4 m

Part ref. 824 02 027 Price: £ 46.22

Schuko sockets

220 V, 16 A, Alternating Current
Open fronted version
Part ref. 500 01 001 Price: £ 37.37
with folding cover
Part ref. 500 01 002 Price: £ 47.20



FI protection switch

220 V
Part ref. 501 01 002 Price: £ 160.49
380 V
Part ref. 501 01 001 Price: £ 145.82



CEE socket

220 V, 16 A, Alternating Current 2 P + E
Part ref. 500 01 005 Price: £ 60.46
380 V, 16 A, 3 phase supply, 3 P + E
Part ref. 500 01 006 Price: £ 70.80



Compressed air outlet to 35 bar

Part ref. 800 01 001 Price: £ 49.17



Mains protection circuit breaker

for Alternating Current, 220 V, 16 A
Part ref. 501 02 001 Price: £ 57.04
for 3 phase supply, 380 V, 16 A
Part ref. 501 02 002 Price: £ 169.14



Emergency isolator

manual operation
Part ref. 501 03 001 Price: £ 72.77



Warning lights

red
Part ref. 505 01 001 Price: £ 82.61
yellow
Part ref. 505 01 002 Price: £ 82.61



Key switch

with 2 keys
Part ref. 501 03 002 Price: £ 116.04



Standard paint finish

RAL 7035 light grey

Easily and quickly assembled with no fixings.
 Welded tubular steel frame with toolbox stand on model W 1000.
 30 mm thick Multiplex worktop with rounded and protected edges.
 Retention bar to lock bench in place & prevent folding.

Standard colour: RAL 8019, grey brown

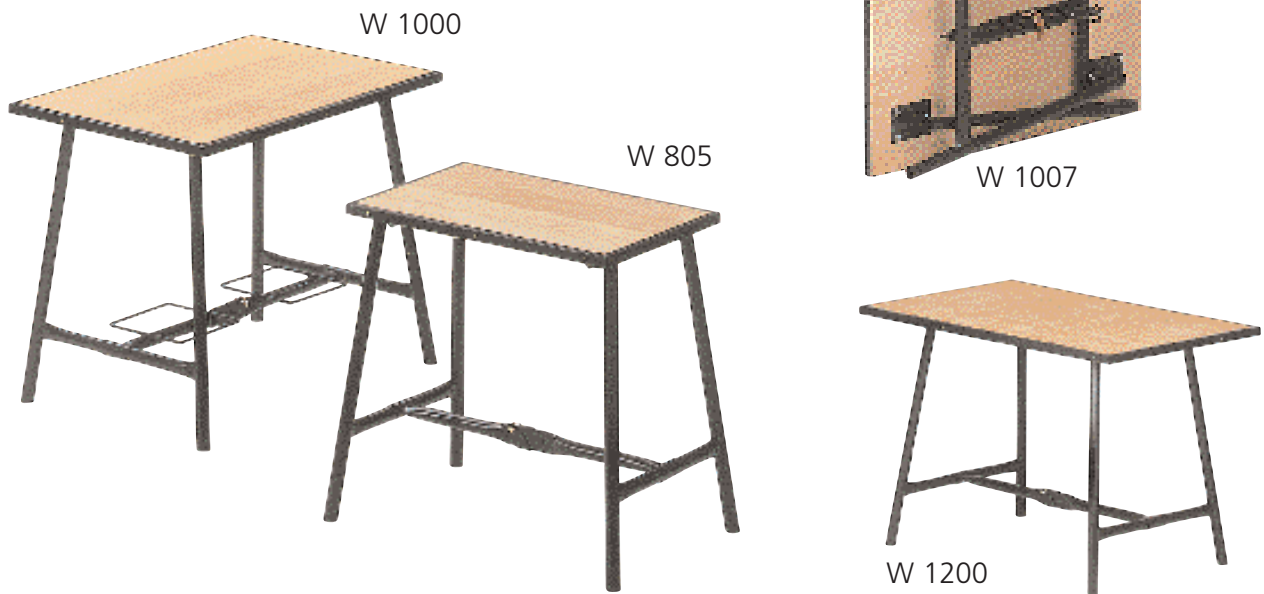

Description	Dimensions W x D x H mm	Weight kg	Part ref.	Price £
W 805	800 x 500 x 840	22.0	110 25 004	111.00
W 1007	1000 x 700 x 840	30.0	110 25 001	115.00
W 1200	1200 x 750 x 840	36.0	110 25 003	135.00
W 1000 with toolbox rack	1000 x 500 x 840	32.0	110 25 002	118.00

Drawer
Cabinets

Workbenches

Workstation
Systems APS

Mobile
Equipment

Storage
Cupboards

Combination Drawer
& Shelving System

Drawer
Dividers

Perfo® System

CNC System

Cases

Quality vice with tube clamping jaws

Available in 4 jaw widths. The forged jaws provide secure clamping of pipes and are therefore ideally suited to installation work.

All highly stressed parts like front and rear jaws, anvil, spindle, and guide rails are produced from high quality drop-forged steel.

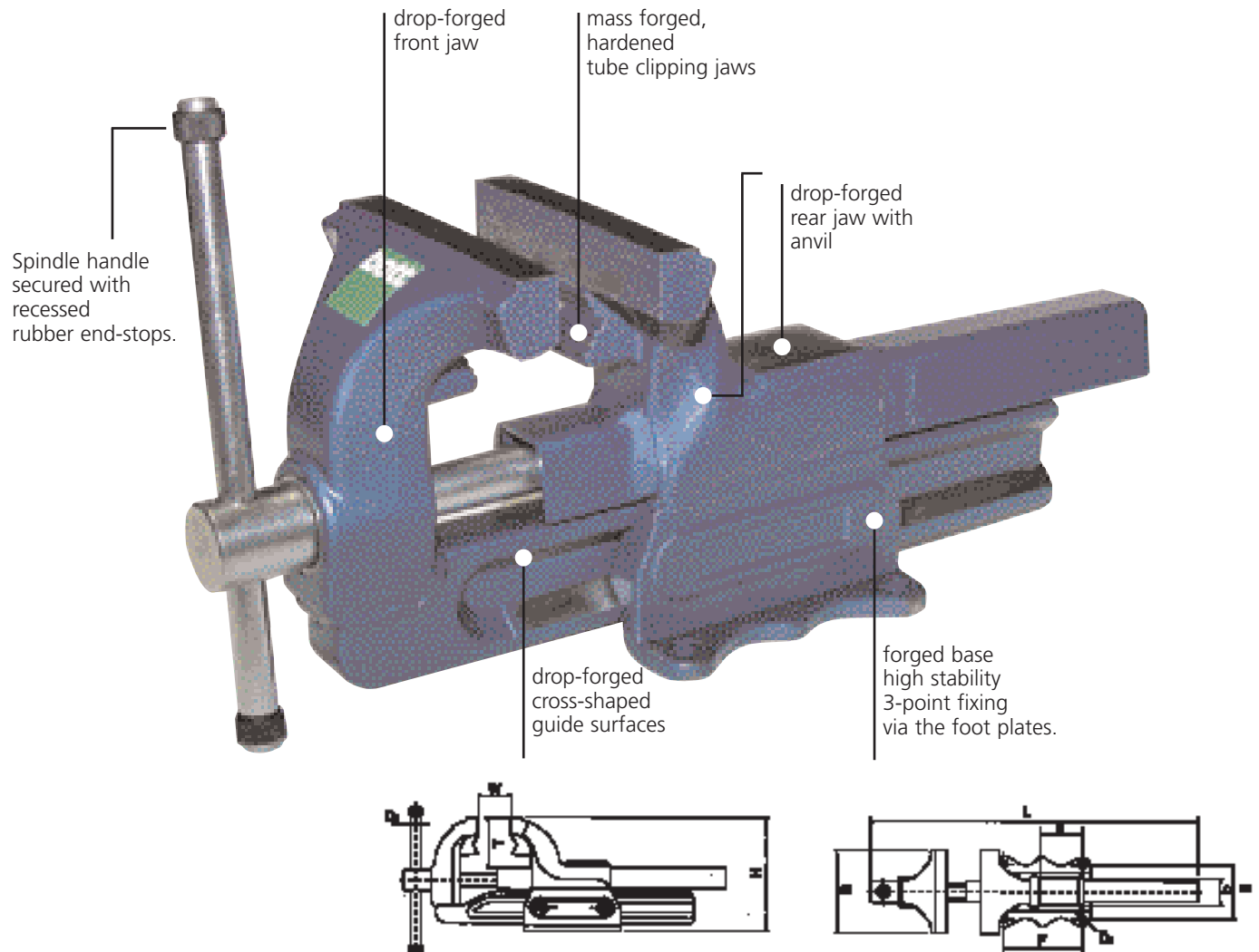

Technical data Vice

Size			100	120	140	160
Jaw width	W	mm	100	120	140	160
max. jaw opening	W	≈ mm	130	150	200	230
Jaw depth	S	mm	55	70	87	103,5
Vice height	H	mm	127	163,5	194,5	230
Anvil size	axb	mm	35 x 35	50 x 40	58 x 55	70 x 60
Spindle diameter	D2	mm	13	13	16	18
Fixing hole diameter	D1	mm	9,5	11,5	11,5	14
fixing hole spacing	F x E		72 x 58	97 x 76	119 x 95	139 x 121
Total length	L	mm	290	370	465	550
Weight		≈ kg	4,5	9	16	27
Clamps tubes from/to		mm	Y 13-40	Y 16-58	Y 18-80	Y 18-98
Weight of the turntable (complete)		≈ kg	1,5	2,5	5	7,5

Workbench accessories

Vices

Anvil

work-hardened, suitable for repair and bench work, jaws are milled, surface hardened (54-58 Rockwell C) and parallel closing.

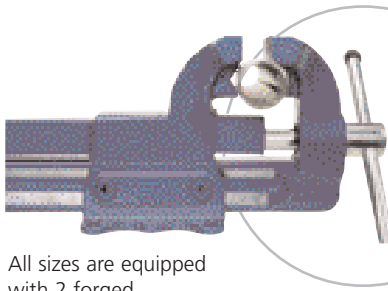

All sizes are equipped with 2 forged induction-hardened tube clamping jaws.

Forged jaws provide for secure clamping of pipes and are therefore ideally suited for installation work.

Turntable

2-piece, consisting of guide ring and spacer, allows 360 degree movement of the vice. Infinite adjustment via integral locking screw.



Cross-shaped guide surfaces

forged steel, sealed against dirt and damage. The newly designed and highly engineered X-form guides, with tighter tolerances, reduce slack and promotes smooth, low friction parallel movement.

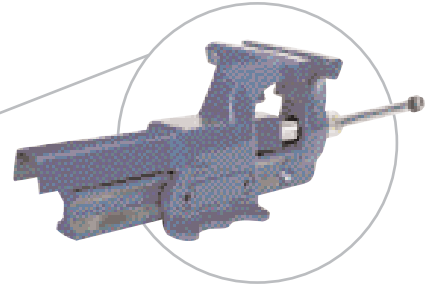

Height adjustment device

provides smooth vertical adjustment, 360 degree rotation, gas strut assisted lift (max. 240 mm)

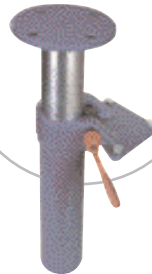

Automatic folding lift

allows the vice to be folded beneath the workbench.

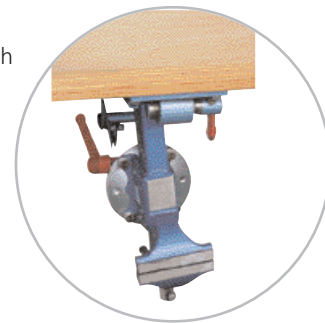
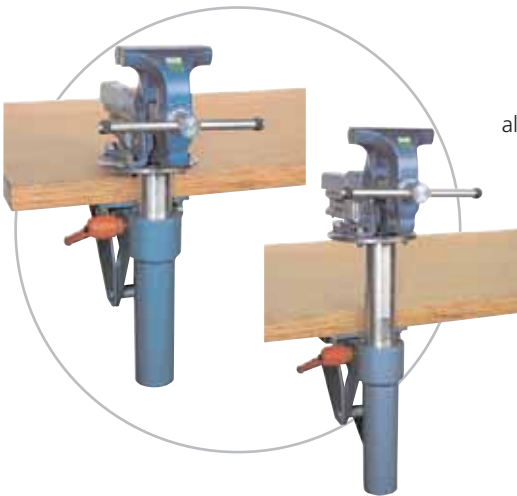

Description	Part ref.	Price £
Vice with jaw width 100 mm	806 01 015	100.35
Vice with jaw width 120 mm	806 01 016	121.96
Vice with jaw width 140 mm	806 01 017	160.86
Vice with jaw width 160 mm	806 01 018	217.45
Turntable for vice with jaw width 100 mm	806 10 001	39.57
Turntable for vice with jaw width 120 mm	806 10 002	50.02
Turntable for vice with jaw width 140 mm	806 10 003	62.74
Turntable for vice with jaw width 160 mm	806 10 004	75.33
Height adjustment device for vice with jaw width 100 mm	806 13 001	167.02
Height adjustment device for vice with jaw width 120 mm	806 13 002	181.65
Height adjustment device for vice with jaw width 140 mm	806 13 003	181.65
Height adjustment device for vice with jaw width 160 mm	806 13 004	172.51
Automatic folding lift* for vice with jaw width 100 mm	806 13 005	277.83
Automatic folding lift* for vice with jaw width 120 mm	806 13 006	287.19

* incl. height adjustment device

Drawer Cabinets

Workbenches

Workstation Systems APS

Mobile Equipment

Storage Cupboards

Combination Drawer & Shelving System

Drawer Dividers

Perfo® System

CNC System

Cases



Workstand

- Gas spring assisted height and seat tilt adjustment
- Seat angle adjustment 0° - 8°
- Durable and comfortable moulded foam seat

Description	Height mm	Part ref.	Price £
Workstand	550-660 mm	886 01 022	122.00

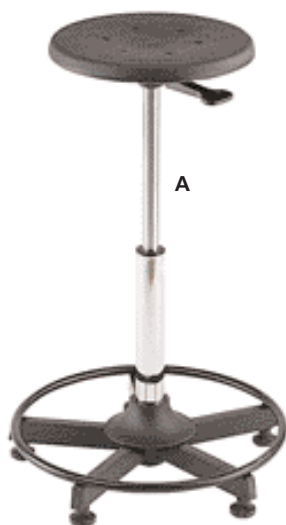

Stool – fixed and with castors

- For stool - fixed and with castors - Gas spring assisted height adjustment
- For stool - fixed and with castors - Low wear polyurethane seat

Fig.	Description	Height mm	Part ref.	Price £
A	Fixed stool	510-770 mm	886 01 020	97.00
B	Roller stool	360-475 mm	886 01 003	119.00
C	Roller stool	510-770 mm	886 01 002	133.00



Classic chairs

- Backrest angle adjustment up to 10°
- Backrest adjustable in height
- Seat tilt can be free floating or fixed in any position
- High quality gas lift mechanism for automatic seat height adjustment
- Model "B" includes footrest

Fig.	Height mm	Part ref.	Price £
A	430-560	886 01 008	140.00
B	550-800	886 01 007	153.00



Comfort chairs

- Max. 10° backrest angle adjustment
- Height adjustable and pivotable backrest cushions
- Seat tilt can be free floating or fixed in any position
- Easy care vinyl backrest and seat with air vents
- High quality gas filled springs for automatic seat height adjustment
- Model "D" includes all-round circular footrest
- Moulded dense foam seat and backrest

Fig.	Height mm	Part ref.	Price £
C	430-560	886 01 010	157.00
D	550-800	886 01 009	207.00



Active chairs

- Max. 10° backrest angle adjustment
- Height adjustable and pivotable seat cushions
- Seat tilt can be free floating or fixed in any position
- Seat cushions and backrest with blue fabric covers and soft plastic edgebanding to prevent fraying
- High quality gas filled springs for automatic seat height adjustment
- Model »F« includes a footrest

Fig.	Height mm	Part ref.	Price £
E	430-560	886 01 012	141.00
F	490-670	886 01 011	160.00



Accessories for chairs

Fig.	Description	Part ref.	Price £
G	Armrest set	886 02 004	44.00
H	Set of castors for chair	886 02 003	33.00

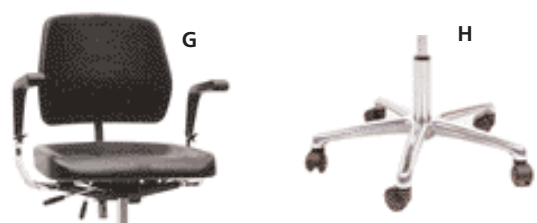

Drawer
Cabinets

Workbenches

Workstation
Systems
APS

Mobile
Equipment

Storage
Cupboards

Combination
Drawer
& Shelving
System

Drawer
Dividers

Perfo®
System

CNC System

Cases

www.bott-group.com

Bott Ltd

Bude & Stratton Business Park, Bude
Cornwall. EX23 8LY

Tel: 01288 357 788

Fax: 01288 352 692

Email: info@bottltd.co.uk

Web: www.bott-group.com

.50

April 2007

@2007MC1.50