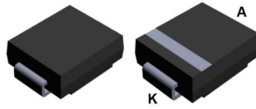

1500 W TVS in SMC

 SMC
(JEDEC DO-214AB)

 Bidirectional
(CA type)

 Unidirectional
(A type)

Features

- Peak pulse power:
 - 1500 W (10/1000 μ s)
 - up to 10 kW (8/20 μ s)
- Stand-off voltage range from 5 V to 188 V
- Unidirectional and bidirectional types
- Low leakage current: 0.2 μ A at 25 °C
- Operating T_j max: 150 °C
- High power capability at T_j max.: up to 1250 W (10/1000 μ s)
- Lead finishing: matte tin plating

Complies with the following standards

- UL94, V0
- J-STD-020 MSL level 1
- J-STD-002, JESD 22-B102 E3 and MIL-STD-750, method 2026
- JESD-201 class 2 whisker test
- IPC7531 footprint and JEDEC registered package outline
- UL 497B file number: QVGQ2.E136224
- IEC 61000-4-4 level 4:
 - 4 kV
- IEC 61000-4-2, C = 150 pF, R = 330 Ω exceeds level 4:
 - 30 kV (air discharge)
 - 30 kV (contact discharge)

Description

The SM15T TVS series is designed to protect sensitive equipment against electrostatic discharges according to IEC 61000-4-2, MIL STD 883 Method 3015, and electrical overstress such as IEC 61000-4-4 and 5. They are used for surges below 1500 W 10/1000 μ s.

This planar technology makes it compatible with high-end equipment and SMPS where low leakage current and high junction temperature are required to provide reliability and stability over time.

Product status link

SM15T	SM15T6V8A , SM15T6V8CA , SM15T7V5A , SM15T7V5CA , SM15T10A , SM15T10CA , SM15T12A , SM15T12CA , SM15T15A , SM15T15CA , SM15T18A , SM15T18CA , SM15T22A , SM15T22CA , SM15T24A , SM15T24CA , SM15T27A , SM15T27CA , SM15T30A , SM15T30CA , SM15T33A , SM15T33CA , SM15T36A , SM15T36CA , SM15T39A , SM15T39CA , SM15T68A , SM15T68CA , SM15T75A , SM15T75CA , SM15T100A , SM15T100CA , SM15T150A , SM15T150CA , SM15T200A , SM15T200CA , SM15T220A , SM15T220CA
-------	--

1 Characteristics

Table 1. Absolute maximum ratings ($T_{amb} = 25\text{ }^{\circ}\text{C}$)

Symbol	Parameter	Value	Unit	
V_{PP}	Peak pulse voltage	IEC 61000-4-2 (C = 150 pF, R = 330 Ω)		
		Contact discharge	30	kV
		Air discharge	30	
P_{PP}	Peak pulse power dissipation	T_j initial = T_{amb}	1500	W
T_{stg}	Storage temperature range		-65 to +150	$^{\circ}\text{C}$
T_j	Operating junction temperature range		-55 to +150	$^{\circ}\text{C}$
T_L	Maximum lead temperature for soldering during 10 s		260	$^{\circ}\text{C}$

Figure 1. Electrical characteristics - parameter definitions

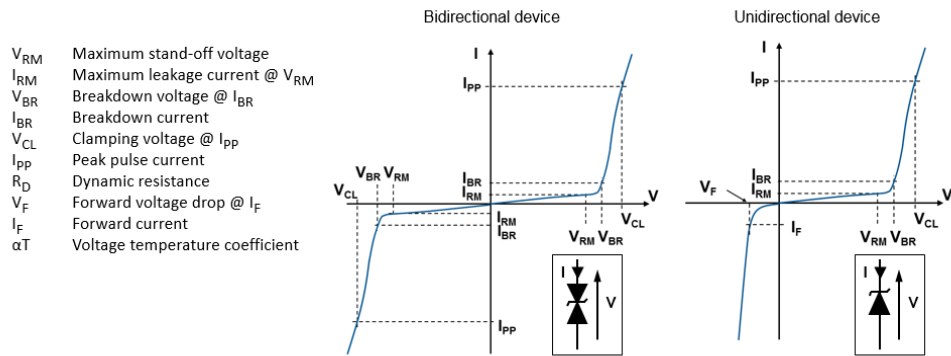

Figure 2. Pulse definition for electrical characteristics

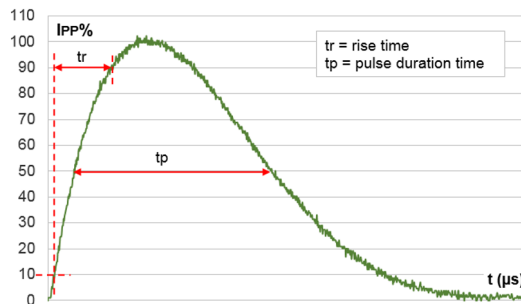

Table 2. Electrical characteristics - parameter values ($T_{amb} = 25\text{ °C}$, unless otherwise specified)

Type	I_{RM} max at V_{RM}			V_{BR} at $I_{BR}^{(1)}$				10 / 1000 μ s			8 / 20 μ s			αT
	25 °C	85 °C		Min.	Typ.	Max.		$V_{CL}^{(2)(3)}$	$I_{PP}^{(4)}$	R_D	$V_{CL}^{(2)(3)}$	$I_{PP}^{(4)}$	R_D	
	μ A	μ A	V	V			mA	Max.		Max.	Max.		Max.	Max.
								V	A	Ω	V	A	Ω	$10^{-4}/\text{°C}$
SM15T6V8A/CA	500	2000	5.8	6.45	6.8	7.14	10	10.5	143	0.023	13.4	746	0.008	5.7
SM15T7V5A/CA	250	1000	6.4	7.13	7.5	7.88	10	11.3	132	0.026	14.5	690	0.010	6.1
SM15T10A/CA	10	50	8.55	9.5	10	10.5	1	14.5	103	0.039	18.6	538	0.015	7.3
SM15T12A/CA	0.2	1	10.2	11.4	12	12.6	1	16.7	90	0.046	21.7	461	0.020	7.8
SM15T15A/CA	0.2	1	12.8	14.3	15	15.8	1	21.2	71	0.076	27.2	368	0.031	8.4
SM15T18A/CA	0.2	1	15.3	17.1	18	18.9	1	25.2	59.5	0.106	32.5	308	0.044	8.8
SM15T22A/CA	0.2	1	18.8	20.9	22	23.1	1	30.6	49	0.153	39.3	254	0.064	9.2
SM15T24A/CA	0.2	1	20.5	22.8	24	25.2	1	33.2	45	0.178	42.8	234	0.075	9.4
SM15T27A/CA	0.2	1	23.1	25.7	27	28.4	1	37.5	40	0.228	48.3	207	0.096	9.6
SM15T30A/CA	0.2	1	25.6	28.5	30	31.5	1	41.5	36	0.278	53.5	187	0.12	9.7
SM15T33A/CA	0.2	1	28.2	31.4	33	34.7	1	45.7	33	0.333	59.0	169	0.14	9.8
SM15T36A/CA	0.2	1	30.8	34.2	36	37.8	1	49.9	30	0.403	64.3	156	0.17	9.9
SM15T39A/CA	0.2	1	33.3	37.1	39	41.0	1	53.9	28	0.461	69.7	143	0.20	10.0
SM15T68A/CA	0.2	1	58.1	64.6	68	71.4	1	92	16.3	1.26	121	83	0.60	10.4
SM15T75A/CA	0.2	1	64.1	71.3	75	78.8	1	103	14.6	1.66	134	75	0.74	10.5
SM15T100A/CA	0.2	1	85.5	95.0	100	105	1	137	11	2.91	178	56	1.30	10.6
SM15T150A/CA	0.2	1	128	143	150	158	1	207	7.2	6.81	265	38	2.82	10.8
SM15T200A/CA	0.2	1	171	190	200	210	1	274	5.5	11.6	353	28	5.11	10.8
SM15T220A/CA	0.2	1	188	209	220	231	1	328	4.6	21.1	388	26	6.04	10.8

1. To calculate V_{BR} versus T_j : V_{BR} at $T_j = V_{BR}$ at $25\text{ °C} \times (1 + \alpha T \times (T_j - 25))$
2. To calculate V_{CL} versus T_j : V_{CL} at $T_j = V_{CL}$ at $25\text{ °C} \times (1 + \alpha T \times (T_j - 25))$
3. To calculate V_{CL} max versus $I_{PP\text{appli}}$: $V_{CL\text{max}} = V_{CL} - R_D \times (I_{PP} - I_{PP\text{appli}})$ where $I_{PP\text{appli}}$ is the surge current in the application
4. Surge capability given for both directions for unidirectional (A type) and bidirectional (CA type) devices

1.1 Characteristics (curves)

Figure 3. Maximum peak power dissipation versus initial junction temperature

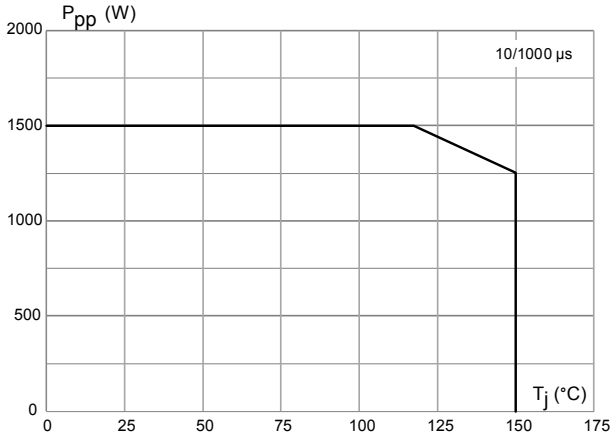

Figure 4. Maximum peak pulse power versus exponential pulse duration

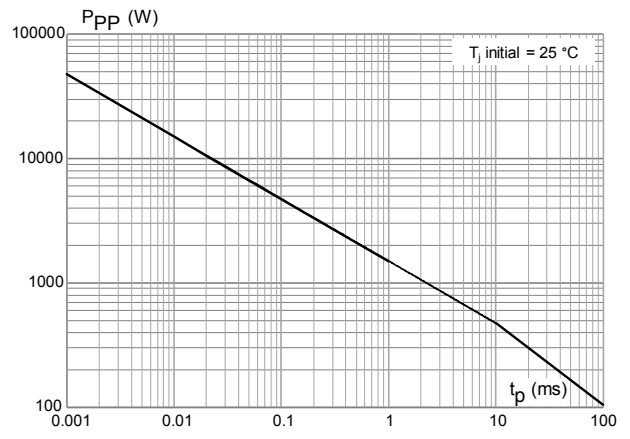

Figure 5. Maximum peak pulse current versus clamping voltage

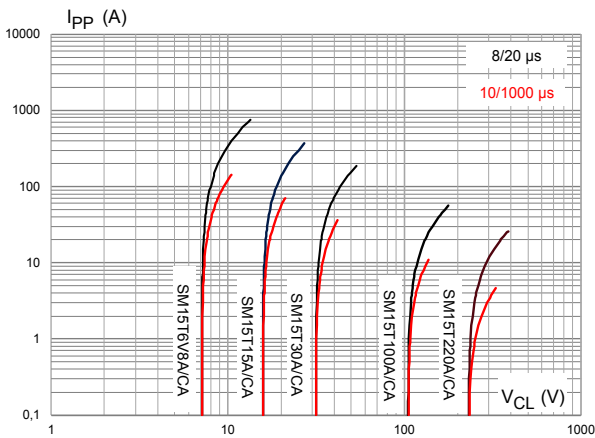

Figure 6. Dynamic resistance versus pulse duration

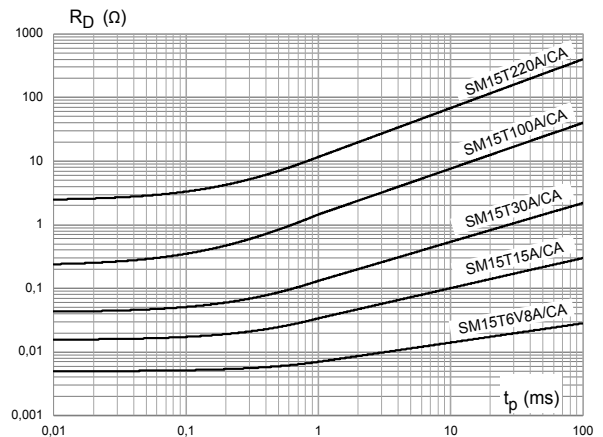

Figure 7. Junction capacitance versus reverse applied voltage (unidirectional type)

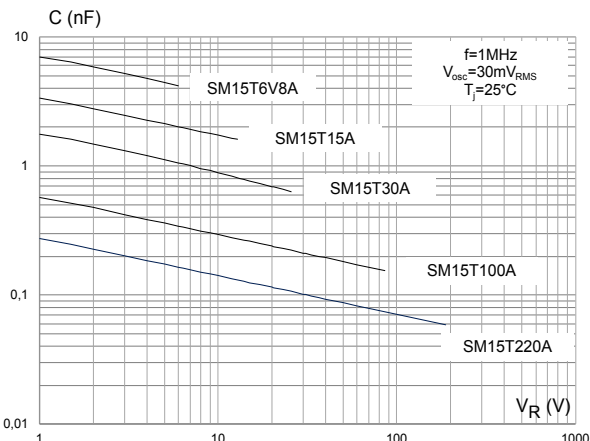

Figure 8. Junction capacitance versus applied voltage (bidirectional type)

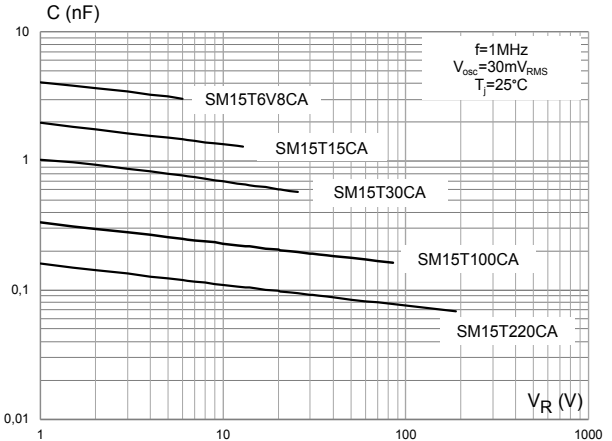

Figure 9. Leakage current versus junction temperature

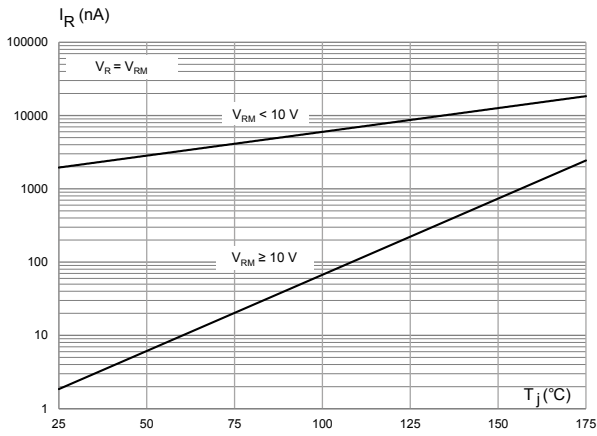

Figure 10. Peak forward voltage drop versus peak forward current

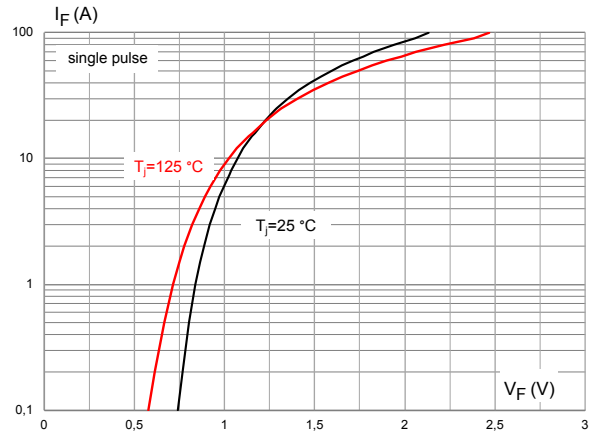

Figure 11. Thermal impedance junction to ambient versus pulse duration

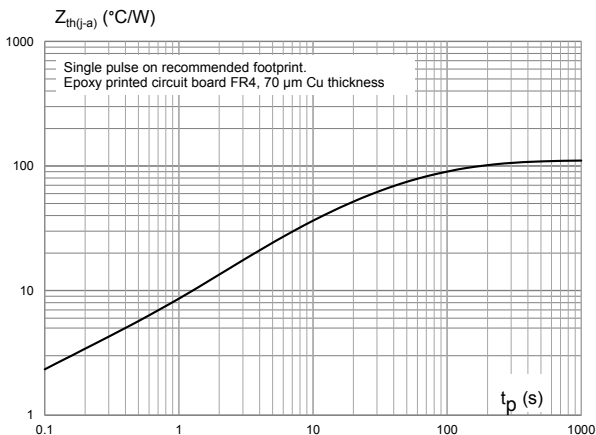
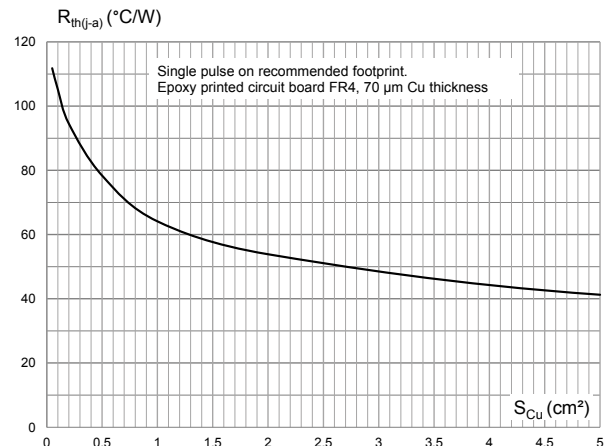

Figure 12. Thermal resistance junction to ambient versus copper area under each lead



2 Package information

In order to meet environmental requirements, ST offers these devices in different grades of **ECOPACK** packages, depending on their level of environmental compliance. ECOPACK specifications, grade definitions and product status are available at: www.st.com. ECOPACK is an ST trademark.

2.1 SMC package information

Figure 13. SMC package outline

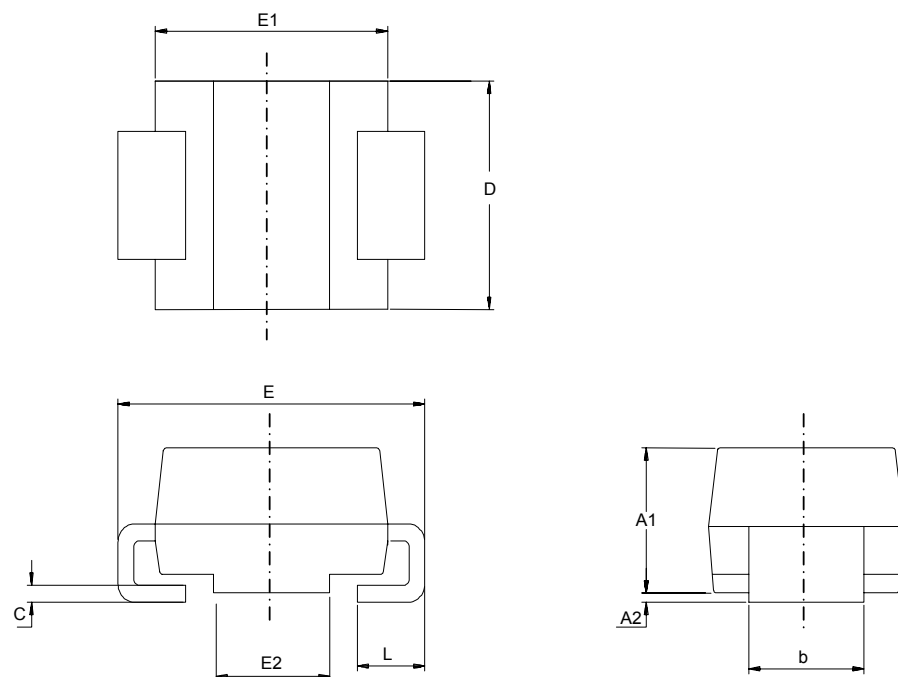

Table 3. SMC package mechanical data

Ref.	Dimensions			
	Millimeters		Inches (for reference only)	
	Min.	Max.	Min.	Max.
A1	1.90	2.45	0.075	0.096
A2	0.05	0.20	0.002	0.008
b	2.90	3.20	0.114	0.126
c	0.15	0.40	0.006	0.016
D	5.55	6.25	0.218	0.246
E	7.75	8.15	0.305	0.321
E1	6.60	7.15	0.260	0.281
E2	4.40	4.70	0.173	0.185
L	0.75	1.50	0.030	0.060

Figure 14. Footprint recommendation

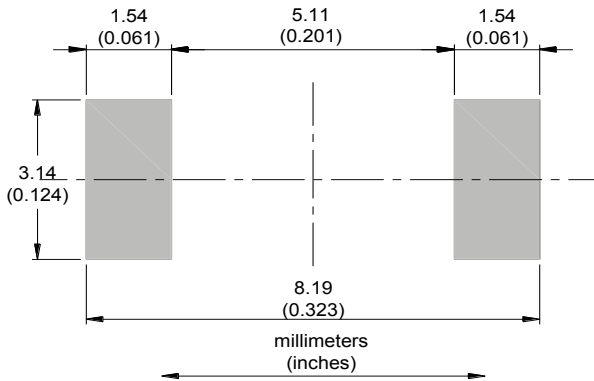

Figure 15. Marking layout

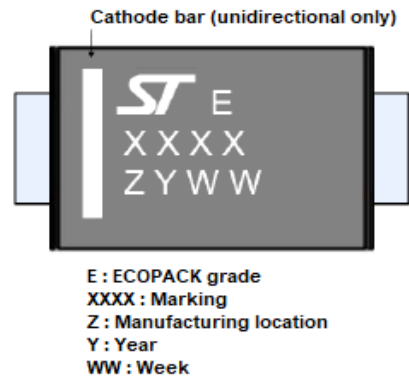
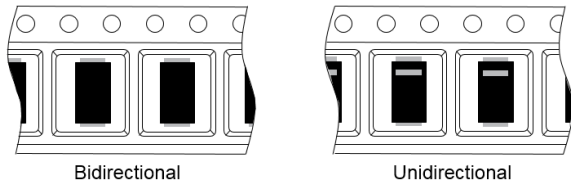

Figure 16. Package orientation in reel



Taped according to EIA-481
Pocket dimensions are not on scale.
Pocket shape may vary depending on package
On bidirectional devices, marking and logo may not be always in the same direction.

Figure 17. Tape and reel orientation

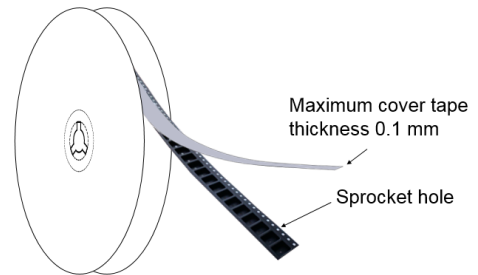

Figure 18. 13" reel dimension values (mm)

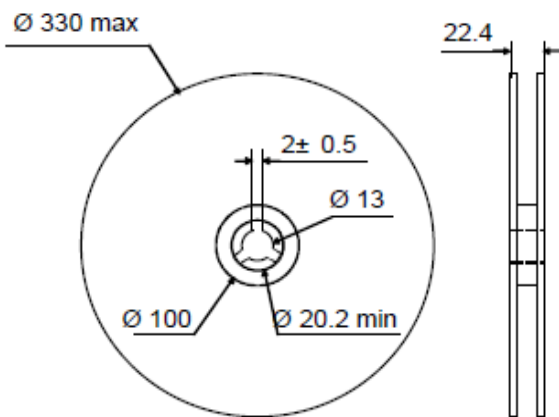

Figure 19. Inner box dimension values (mm)

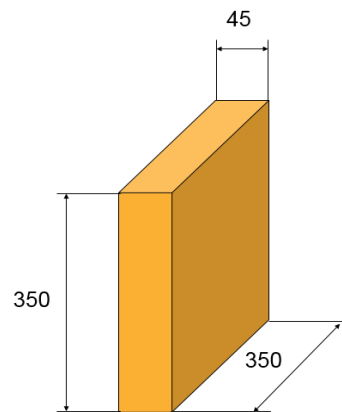
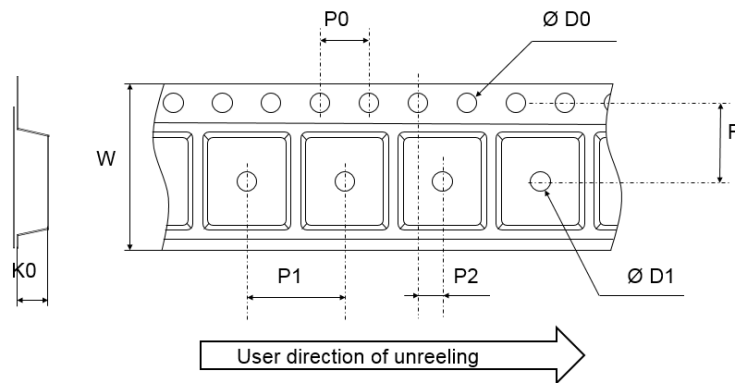

Figure 20. Tape outline



Note: Pocket dimensions are not on scale
Pocket shape may vary depending on package

Table 4. Tape dimension values

Ref.	Dimensions		
	Millimeters		
	Min.	Typ.	Max.
D0	1.4	1.5	1.6
D1	1.5		
F	7.4	7.5	7.6
K0	2.39	2.49	2.59
P0	3.9	4.0	4.1
P1	7.9	8.0	8.1
P2	1.9	2.0	2.1
W	15.7	16	16.3

2.2 Reflow profile

Figure 21. ST ECOPACK recommended soldering reflow profile for PCB mounting

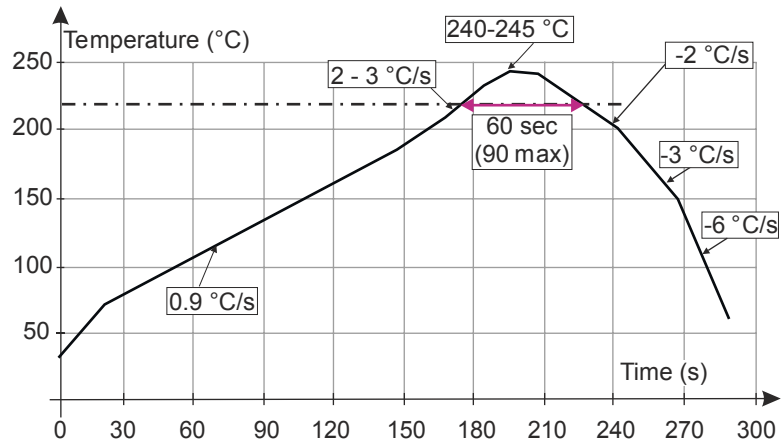

Note: Minimize air convection currents in the reflow oven to avoid component movement. Maximum soldering profile corresponds to the latest IPC/JEDEC J-STD-020.

3 Ordering information

Table 5. Ordering information

Order code	Marking	Package	Weight	Base qty.	Delivery mode
SM15TxxA/CA-TR ⁽¹⁾	See Table 6. Marking	SMC	0.25 g	2500	Tape and reel

1. Where xxx is nominal value of V_{BR} and A or CA indicates unidirectional or bidirectional version.

Table 6. Marking

Order code	Marking	Order code	Marking
SM15T6V8A	MDE	SM15T6V8CA	BDE
SM15T7V5A	MDG	SM15T7V5CA	BDG
SM15T10A	MDP	SM15T10CA	BDP
SM15T12A	MDT	SM15T12CA	BDT
SM15T15A	MDX	SM15T15CA	BDX
SM15T18A	MEE	SM15T18CA	BEE
SM15T22A	MEK	SM15T22CA	BEK
SM15T24A	MEM	SM15T24CA	BEM
SM15T27A	MEP	SM15T27CA	BEP
SM15T30A	MER	SM15T30CA	BER
SM15T33A	MET	SM15T33CA	BET
SM15T36A	MEV	SM15T36CA	BEV
SM15T39A	MEX	SM15T39CA	BEX
SM15T68A	MFP	SM15T68CA	BFP
SM15T75A	MFO	SM15T75CA	BFO
SM15T100A	MFY	SM15T100CA	BFY
SM15T150A	MGK	SM15T150CA	BGK
SM15T200A	MGV	SM15T200CA	BGV
SM15T220A	MGX	SM15T220CA	BGX

Revision history

Table 7. Document revision history

Date	Version	Changes
September-2001	3B	Last issue
19-Feb-2007	4	Peak pulse power Figure 4 on page 4 updated.
04-Feb-2009	5	Updated ECOPACK statement. Added RD columns in Table 3. Updated characteristic curves, Figure 3 to Figure 11.
17-Sep-2009	6	Document updated for low leakage current.
24-Apr-2020	7	Removed figure 12. Minor text changes to improve the readability of the document.
16-May-2022	8	Updated Figure 6 , Figure 7 , Figure 8 and Figure 9 .

IMPORTANT NOTICE – READ CAREFULLY

STMicroelectronics NV and its subsidiaries (“ST”) reserve the right to make changes, corrections, enhancements, modifications, and improvements to ST products and/or to this document at any time without notice. Purchasers should obtain the latest relevant information on ST products before placing orders. ST products are sold pursuant to ST’s terms and conditions of sale in place at the time of order acknowledgment.

Purchasers are solely responsible for the choice, selection, and use of ST products and ST assumes no liability for application assistance or the design of purchasers’ products.

No license, express or implied, to any intellectual property right is granted by ST herein.

Resale of ST products with provisions different from the information set forth herein shall void any warranty granted by ST for such product.

ST and the ST logo are trademarks of ST. For additional information about ST trademarks, refer to www.st.com/trademarks. All other product or service names are the property of their respective owners.

Information in this document supersedes and replaces information previously supplied in any prior versions of this document.

© 2022 STMicroelectronics – All rights reserved