

# General Specifications

## Electrical Capacity (Resistive Load)

<b>Power Level (silver):</b>	6A @ 125V AC or 3A @ 250V AC or 3A @ 30V DC	
<b>Logic Level (gold):</b>	0.4VA maximum @ 28V AC/DC maximum (Applicable Range 0.1mA ~ 0.1A @ 20mV ~ 28V)	
	Note: Find additional explanation of operating range in Supplement section.	

## Other Ratings

<b>Contact Resistance:</b>	10 milliohms maximum for silver; 20 milliohms maximum for gold	
<b>Insulation Resistance:</b>	1,000 megohms minimum @ 500V DC	
<b>Dielectric Strength:</b>	1,000V AC minimum between contacts for 1 minute minimum; 1,500V AC minimum between contacts & case for 1 minute minimum	
<b>Mechanical Life:</b>	50,000 operations minimum	
<b>Electrical Life:</b>	25,000 operations minimum	
<b>Nominal Operating Force:</b>	On-to-On Position	Off-to-On Position
	Single Pole	3.19N
	Double Pole	4.41N
		3.92N
		7.06N
<b>Angle of Throw:</b>	20°	

## Materials & Finishes

<b>Bushing:</b>	Brass with nickel plating
<b>Housing:</b>	Stainless steel
<b>Mounting Bracket:</b>	Steel with tin plating
<b>Movable Contacts:</b>	Silver alloy or silver alloy with gold plating
<b>Stationary Contacts:</b>	Silver with silver plating or copper or brass with gold plating
<b>Lamp Contacts:</b>	Phosphor bronze
<b>Base:</b>	Diallyl phthalate (UL94V-0)
<b>Switch Terminals:</b>	Copper with silver or gold plating
<b>Lamp Terminals:</b>	Brass with silver or gold plating

## Environmental Data

<b>Operating Temp Range:</b>	-10°C through +55°C (+14°F through +131°F)
<b>Humidity:</b>	90 ~ 95% humidity for 96 hours @ 40°C (104°F)
<b>Vibration:</b>	10 ~ 55Hz with peak-to-peak amplitude of 1.5mm traversing the frequency range & returning in 1 minute; 3 right angled directions for 2 hours
<b>Shock:</b>	50G (490m/s <sup>2</sup> ) acceleration (tested in 6 right angled directions, with 5 shocks in each direction)

## Installation

<b>Mounting Torque:</b>	1.47Nm (13 lb•in) for double nut; .67Nm (6 lb•in) for single nut
<b>Soldering Time &amp; Temp:</b>	Wave Soldering (PC version): See Profile B in Supplement section. Manual Soldering: See Profile B in Supplement section. Note: Lever must be in center position while soldering.
<b>Cleaning:</b>	PC mountable device is not process sealed. Hand clean locally using alcohol based solution.

## Standards & Certifications

<b>Flammability Standards:</b>	UL94V-0 base
<b>UL:</b>	<b>File No. E44145 - Recognized only when ordered with marking on switch.</b> Add "/U" to end of part number to order UL recognized switch. Single pole with synchronous circuits & single color LEDs & solder lug or PC recognized at 6A @ 125V AC.
<b>CSA:</b>	<b>File No. 023535_0_000 - Certified only when ordered with marking on switch.</b> Add "/C" to end of part number to order CSA certified switch. All single pole with synchronous circuits & single color LEDs certified at 6A @ 125V AC.

# Distinctive Characteristics

Industry's first LED illumination at tip of toggle switches.

Single color LEDs of red, yellow, and green, plus bicolor red/green, to meet varied design requirements.

LEDs can operate independently from or synchronously with switching operation.

Antijamming feature to protect contacts from damage due to excessive downward force on the toggle.

High torque bushing prevents the bushing from rotating or separating from the metal frame during installation.

Stainless steel frame resists corrosion.

Silver contacts are of specially composed alloy for hardness.

High insulating barriers protect against crossover in double pole devices.

Terminals are molded in and epoxy sealed to lock out flux, dust, and other contaminants.

1,500V dielectric strength between switch contacts and case is accomplished by clinching the frame away from the terminals.



Actual Size



A

Toggles

Rockers

Pushbuttons

Illuminated PB

Programmable

Keylocks

Rotaries

Slides

Tactiles

Tilt

Touch

Indicators

Accessories

Supplement

### TYPICAL SWITCH ORDERING EXAMPLE

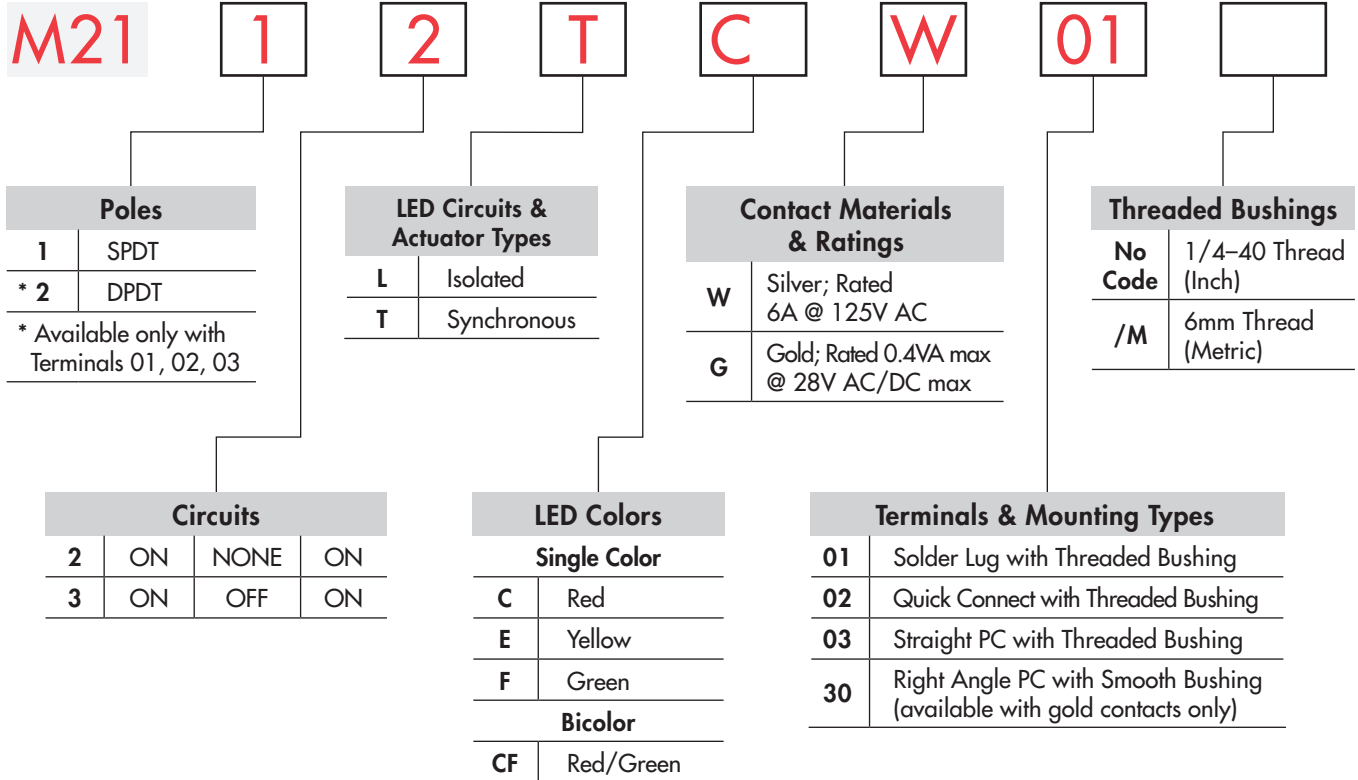

#### IMPORTANT:





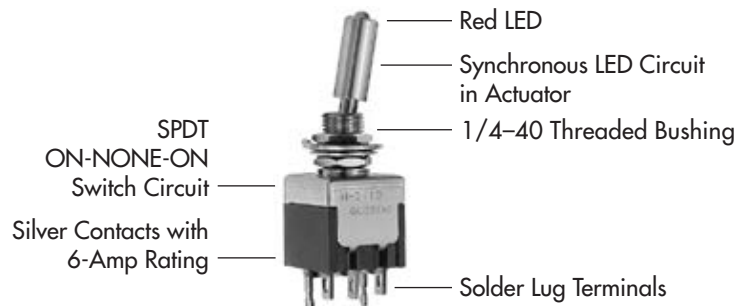

Switches are supplied without UL & CSA marking unless specified.  
**UL & CSA recognized only when ordered with marking on the switch.**  
 Specific models, ratings, & ordering instructions are noted on the General Specifications page.

#### DESCRIPTION FOR TYPICAL ORDERING EXAMPLE

### M2112TCW01

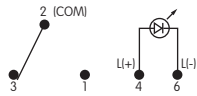
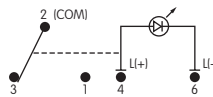

## POLES & CIRCUITS & LED ILLUMINATION

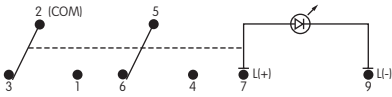
Model	Pole & Throw	Toggle Position & Terminal Numbers			Schematics
		Down 	Center 	Up 	
Notes: Terminal numbers are not actually on the switch. LEDs require an external power source.					
<b>M2112</b>	<b>SPDT</b>	ON	NONE	ON	Isolated Single Color LED 
Connected Power Terminals		2-3	NONE	2-1	
LED Circuit	Isolated LEDs (see schematics) Connected LED Terminals	ON 4-6	NONE NONE	ON 4-6	
	Synchronous Single Color LED Connected LED Terminals	ON 4-6	NONE NONE	OFF OPEN	
	Synchronous Bicolor LED Connected LED Terminals	Red 5-6	NONE NONE	Green 5-4	
<b>M2113</b>	<b>SPDT</b>	ON	OFF	ON	Synchronous Single Color LED 
Connected Power Terminals		2-3	OFF OPEN	2-1	
LED Circuit	Isolated LEDs (see schematics) Connected LED Terminals	ON 4-6	ON 4-6	ON 4-6	
	Synchronous Single Color LED Connected LED Terminals	ON 4-6	OFF OPEN	ON 4-6	
	Synchronous Bicolor LED Connected LED Terminals	Red 5-6	OFF OPEN	Green 5-4	
<b>M2122</b>	<b>DPDT</b>	ON	NONE	ON	Isolated Single Color LED 
Connected Power Terminals		2-3 5-6	NONE NONE	2-1 5-4	
LED Circuit	Isolated LEDs (see schematics) Connected LED Terminals	ON 7-9	NONE NONE	ON 7-9	
	Synchronous Single Color LED Connected LED Terminals	ON 7-9	NONE NONE	OFF OPEN	
	Synchronous Bicolor LED Connected LED Terminals	Red 8-9	NONE NONE	Green 8-7	
<b>M2123</b>	<b>DPDT</b>	ON	OFF	ON	Synchronous Single Color LED 
Connected Power Terminals		2-3 5-6	OFF OPEN	2-1 5-4	
LED Circuit	Isolated LEDs (see schematics) Connected LED Terminals	ON 7-9	ON 7-9	ON 7-9	
	Synchronous Single Color LED Connected LED Terminals	ON 7-9	OFF OPEN	ON 7-9	
	Synchronous Bicolor LED Connected LED Terminals	Red 8-9	OFF OPEN	Green 8-7	

A  
Toggles

Rockers

Pushbuttons

Illuminated PB

Programmable

Keylocks

Rotaries

Slides

Tactiles

Tilt

Touch

Indicators

Accessories

Supplement

## LED COLORS & SPECIFICATIONS

The electrical specifications shown are determined at a basic temperature of 25°C. LED circuit is isolated and requires an external power source. If the source voltage exceeds the rated voltage, a ballast resistor is required. The resistor value can be calculated by using the formula in Supplement Section.

The LED is an integral part of the switch and not available separately.  Bicolor LED is translucent white when unlit.		Single Color			Bicolor	
		<b>C</b>	<b>E</b>	<b>F</b>	<b>CF</b>	Units
Color		Red	Yellow	Green	Red/Green	
Maximum Forward Current	$I_{FM}$	30	30	30	25	mA
Typical Forward Current	$I_F$	20	20	20	10	mA
Forward Voltage	$V_F$	2.2	2.1	2.2	1.7/2.0	V
Maximum Reverse Voltage	$V_{RM}$	4	4	4	—	V
Current Reduction Rate Above 25°C	$\Delta I_F$	0.38	0.38	0.38	0.33/0.33	mA/°C
Ambient Temperature Range		-10° ~ +55°C				

## LED CIRCUIT, TOGGLE, & MOUNTING TYPE COMBINATIONS



**Toggle with Isolated LED Circuit**



**Toggle with Synchronous LED Circuit**

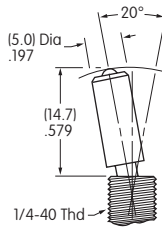

Threaded Bushing combines with Terminal codes 01, 02, & 03.

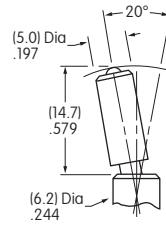

Smooth Bushing combines with Terminal code 30.

Max. Panel Thickness with Standard Hardware .102" (2.6mm)

Max. Panel Thickness without Locking Ring .134" (3.4mm)

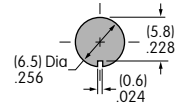
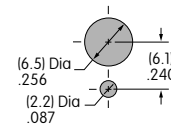

Finish: Brushed aluminum

Standard Hardware: 2 AT513H Hex Nuts, 1 AT507H Locking Ring, 1 AT509 Lockwasher Standard & optional hardware details in Accessories & Hardware section.

## TYPICAL SWITCH DIMENSIONS

### Solder Lug

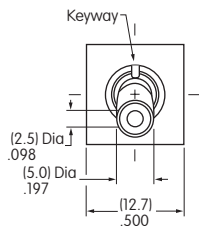

### Single Pole

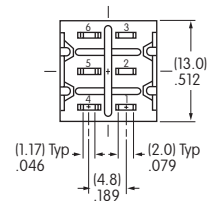
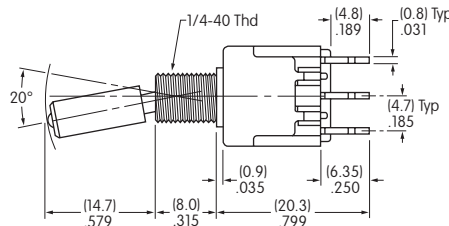

**M2112TCFW01**

Single color LED switch does not have terminal 5.

TYPICAL SWITCH DIMENSIONS

Double Pole

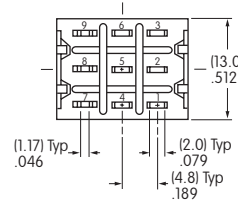
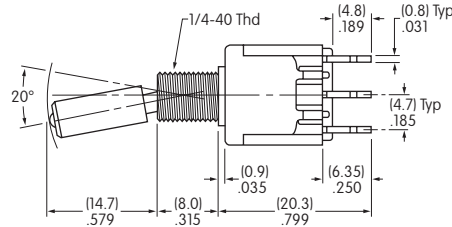
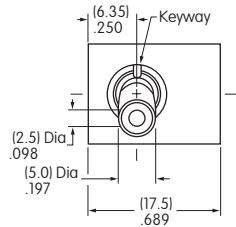

Solder Lug



Single color LED switch does not have terminal 8.

M2122TCFW01

Single Pole Only

Right Angle PC

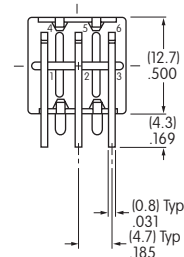
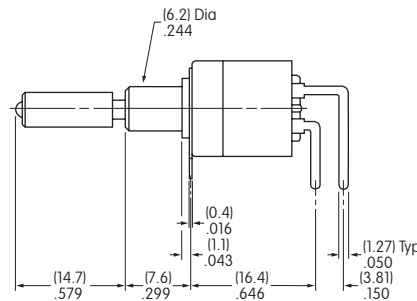
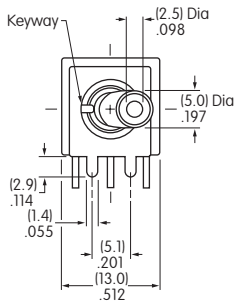

Single color LED switch does not have terminal 5.

Gold contact material only

M2112TCFG30

CONTACT MATERIALS & RATINGS



Silver over Silver

Power Level

6A @ 125V AC & 3A @ 250V AC



Gold over Brass or Copper

Logic Level

0.4VA maximum @ 28V AC/DC maximum

Complete explanation of operating range in Supplement section.

## TERMINALS

### 01 Solder Lug with Turret LED Terminal

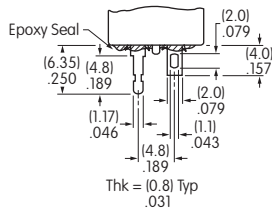

### 02 Quick Connect

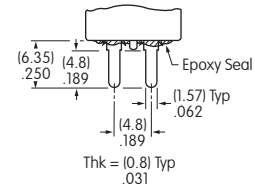

### 03 Straight PC with Turret LED Terminal

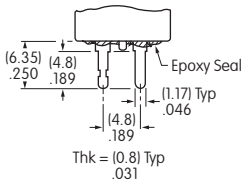

#### Single Pole

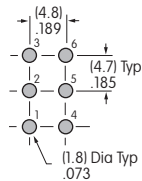

Single color LED & isolated bicolor LED switches do not have terminal 5.

#### Double Pole

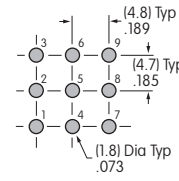

Single color LED & isolated bicolor LED switches do not have terminal 8.

### 30 Right Angle PC

LED terminals only available in brass with silver plating

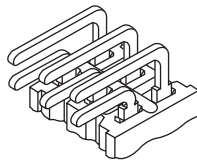

#### Single Pole

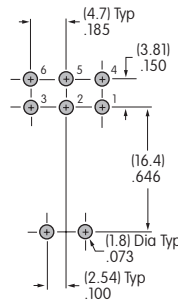

Single color LED & isolated bicolor LED switches do not have terminal 5.

## STANDARD MOUNTING HARDWARE

### AT513H Hexagon Nut (2 per switch)

Material: Brass with nickel plating

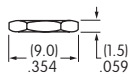
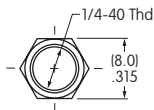

### AT507H Locking Ring (1 per switch)

Material: Steel with chromate over zinc

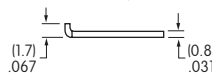
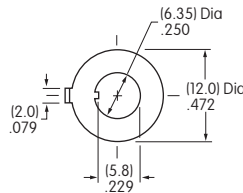

### AT509 Lockwasher (1 per switch)

Material: Steel with chromate over zinc

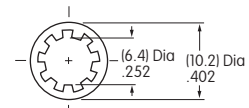

Optional Hardware: Knurled nuts, dress nuts, and ON-OFF plates are available; see details in Accessories & Hardware section.