

# IB and IS series

## Sealed momentary pushbutton switches

*Distinctive features and specifications*



- Snap-in and threaded bushing models
- Compact, light in weight
  - Behind-panel depth of 13 mm (.512) only
  - 50 % reduction in weight compared to metallic models
- Tactile feedback
- Sealed to IP 67

### ENVIRONMENTAL SPECIFICATIONS

- Degree of protection : IP 67 - See details page B36.
- Shock resistance : 100 g according to IEC 512-4, test 6c
- Vibration resistance : 10-500 Hz - 10 g according to IEC 512-4, test 6d
- Salt spray : IEC 512-6, test 11f
- Operating temperature : -40°C to +85°C

### MATERIALS

- Case : thermoplastic UL94-V0
- Plunger : polyamide 6/6
- Bushing/bezel : polyamide 6/6
- Contacts : silver, gold plated
- Terminal seal : epoxy

### ELECTRICAL AND GENERAL SPECIFICATIONS

- Max. current/voltage rating with resistive load :  
400mA 32VAC - 100mA 50VDC - 125mA 125VAC
- Initial contact resistance : 50 mΩ max.
- Insulation resistance : 1 GΩ min. at 500VDC
- Dielectric strength : 1.000 VAC rms
- Electrical life at full load : 500.000 cycles
- Panel thickness :
  - IB series : 0,8 mm (.031) min. - 1,8 mm (.071) max.
  - IS series : 1,5 mm (.059) min. - 4 mm (.157) max.
- Total travel : 1,5 mm (.059)
- Operating force : 2N to 5N
- Contact bounce : 10 ms
- Mechanical life : 1.000.000 cycles
- Torque : 1,5 Nm max. applied to nut
- Soldering : 300°C max. for 3 seconds

*Example of custom switch:  
see end of the series.*

# IB and IS series

## Sealed momentary pushbutton switches

Overview

MODEL  
STRUCTURE

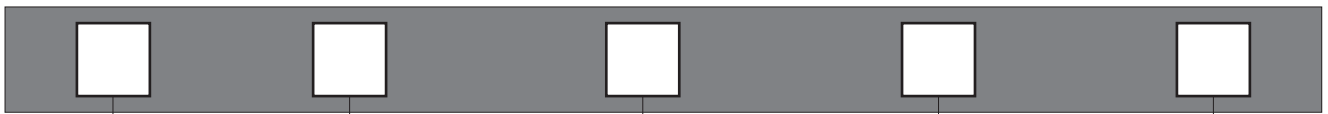

SERIES	
<b>IB</b>	Snap-in
<b>IS</b>	Threaded bushing

Bezel shape	
<b>R</b>	Round, curved
<b>P</b>	Round, flat

Electrical function	
<b>3</b>	Normally open (NO)

Terminals	
<b>S</b>	Solder lug
<b>Z1</b>	Quick-connect 2,8 x 0,5 mm
<b>P</b>	Straight PC

Contacts	
<b>AD</b>	Silver, gold plated

OPTIONS

Plunger colour	
<b>1</b>	Blue
<b>1/4</b>	Dark blue
<b>2</b>	Black
<b>3</b>	Green
<b>5</b>	Yellow
<b>6</b>	Red
<b>7/1</b>	White
<b>8</b>	Bright chrome
<b>9</b>	Orange
<b>A</b>	Satin chrome

Bezel finish	
<b>00</b>	Black (std)
<b>08</b>	Bright chrome (IS only)
<b>10</b>	White
<b>20</b>	Satin chrome (IS only)

Option	
<b>104</b>	High Plunger

### ABOUT THIS SERIES

On the following pages, you will find successively :

- model structure of switches and options in the same order as in above chart

**Dimensions** : first dimensions are in mm while inches are shown as bracketed numbers.



**NOTICE** : please note that not all combinations of above numbers are available. Refer to the following pages for further information.



**A sealing boot** is available to protect the switches against frost and sand. It is presented at the end of the series and in section H.



**Mounting accessories** : Standard hardware supplied : 1 flat seal (IB series)  
1 hex nut 14 mm (.551) across flats and 1 flat seal (IS series). The hex nut is presented in section I (part number U166).



**Packaging unit** : 50 pieces

# IB and IS series

## Sealed momentary pushbutton switches

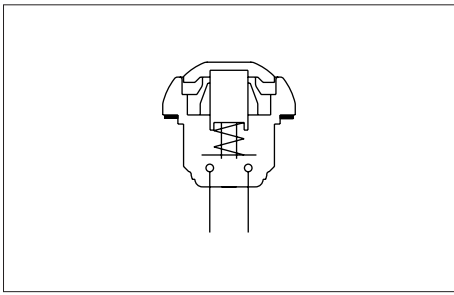

- Ten plunger colours
- Curved or flat actuator
- Antirotation bushing

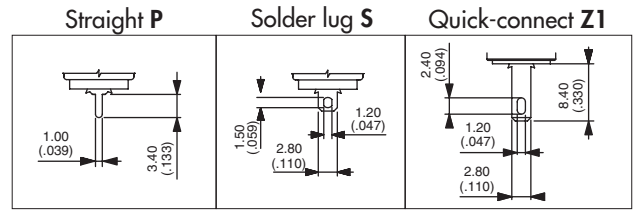

### MODEL STRUCTURE

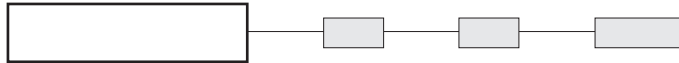

B

### Snap-in mounting - solder lugs

→ Flat

Panel thickness : 0,8 mm to 1,8 mm



Curved actuator  
**IBR3SAD**



Normally open

Flat actuator  
**IBP3SAD**



Normally open

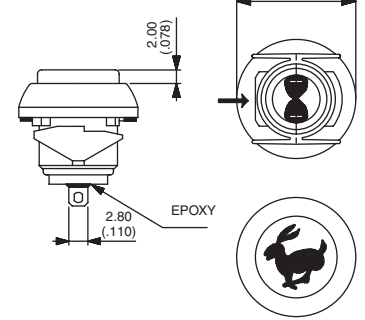
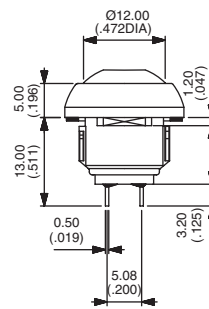

Also available with straight PC : **IB•3PAD** or quick-connect terminals : **IB•3Z1AD**

### Mounting by threaded bushing - solder lugs

→ Flat

Panel thickness : 1,5 mm to 4 mm



**ISR3SAD**



Normally open

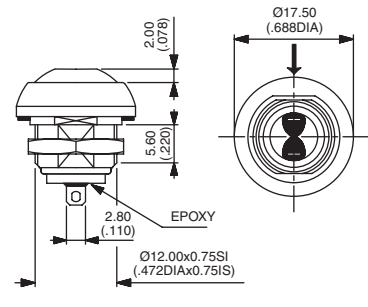
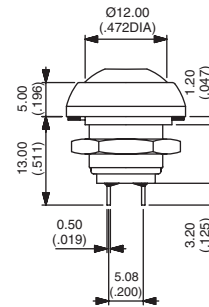

Also available with straight PC : **ISR3PAD** or quick-connect terminals : **ISR3Z1AD**  
Also available with flat actuator. On request.

### PLUNGER COLOUR



Plunger marking available on IBP models (symbol 10 mm max.). On request.



1 : blue - 1/4 : dark blue - 2 : black - 3 : green - 5 : yellow - 6 : red - 7/1 : white - 8 : bright chrome  
9 : orange - A : satin chrome

### BUSHING AND BEZEL FINISH

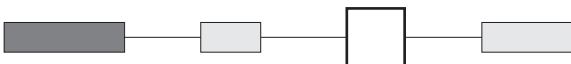

00 : Black (standard)  
08 : Bright chrome (IS series only)  
10 : White  
20 : Satin chrome (IS series only)

# IB and IS series

Sealed momentary pushbutton switches

## PLUNGER OPTION



104 : High plunger

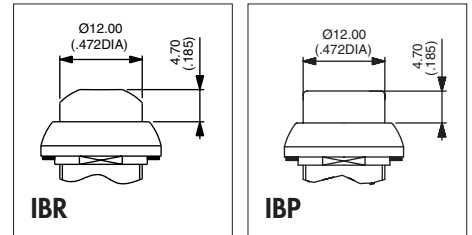

## IB SERIES MOUNTING

### Panel cut-out

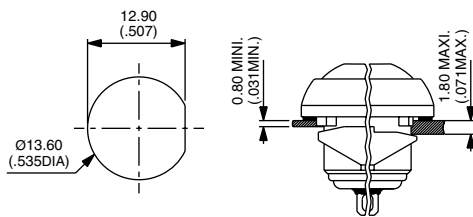

### Matrix mounting

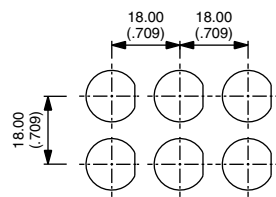

## TACTILE FEEDBACK

### Cross section

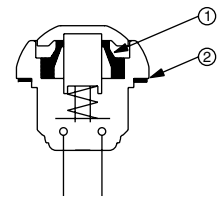

① Elastomeric membrane ② Flat seal

### Operating force/travel

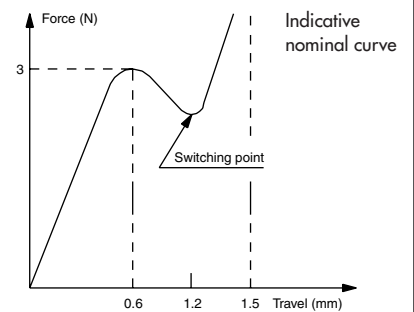

## IS SERIES MOUNTING

### Panel cut-out

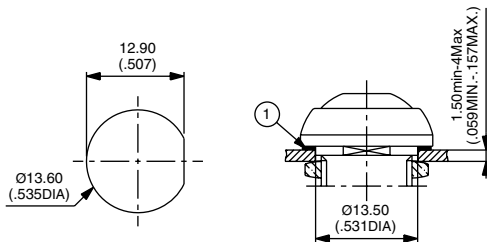

### Matrix mounting

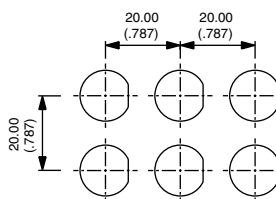

## ADDITIONAL SEALING

By silicone boot for protection against frost and abrasion by sand. Order separately.

- transparent : **U5125**
- blue : **U5125-1**
- black : **U5125-2**
- red : **U5125-6**

Operating temperature : -40°C to +125°C  
Life expectancy : 500.000 cycles

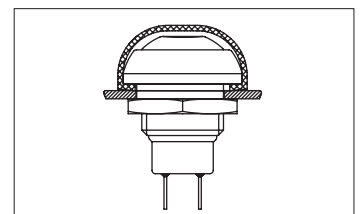
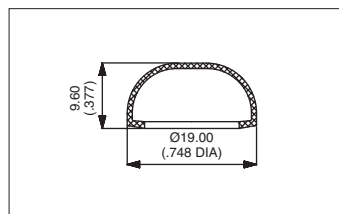

## Example of custom switch



ISR3FADB22X1248-01

- Painted bushing and actuator, soft feel
- Wire leads (55 mm) + connector
- Overmolded rear part