

LM3671, LM3671Q 2MHz, 600mA Step-Down DC-DC Converter

Check for Samples: [LM3671](#), [LM3671Q](#)

FEATURES

- 16 μA Typical Quiescent Current
- 600 mA Maximum Load Capability
- 2 MHz PWM Fixed Switching Frequency (typ.)
- Automatic PFM/PWM Mode Switching
- Internal Synchronous Rectification for High Efficiency
- Internal Soft start
- 0.01 μA Typical Shutdown Current
- Operates from a Single Li-Ion Cell Battery
- Only Three Tiny Surface-Mount External Components Required (One Inductor, Two Ceramic Capacitors)
- Current Overload and Thermal Shutdown Protection
- Available in Fixed Output Voltages and Adjustable Version
- LM3671Q is an Automotive Grade Product that is AEC-Q100 Grade 1 Qualified
- SOT-23, 5-Bump DSBGA and 6-Pin USON Packages

APPLICATIONS

- Mobile Phones
- PDAs
- MP3 Players
- W-LAN
- Portable Instruments
- Digital Still Cameras
- Portable Hard Disk Drives
- Automotive

DESCRIPTION

The LM3671 step-down DC-DC converter is optimized for powering low voltage circuits from a single Li-Ion cell battery and input voltage rails from 2.7V to 5.5V. It provides up to 600 mA load current, over the entire input voltage range. There are several different fixed voltage output options available as well as an adjustable output voltage version range from 1.1V to 3.3V.

The device offers superior features and performance for mobile phones and similar portable systems. Automatic intelligent switching between PWM low-noise and PFM low-current mode offers improved system control. During PWM mode, the device operates at a fixed-frequency of 2 MHz (typ.). Hysteretic PFM mode extends the battery life by reducing the quiescent current to 16 μA (typ.) during light load and standby operation. Internal synchronous rectification provides high efficiency during PWM mode operation. In shutdown mode, the device turns off and reduces battery consumption to 0.01 μA (typ.).

TYPICAL APPLICATION CIRCUITS

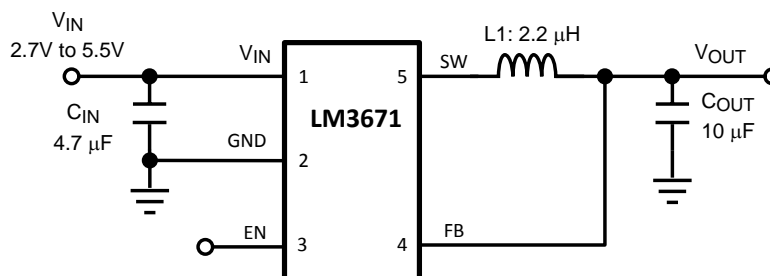

Figure 1. Typical Application Circuit



Please be aware that an important notice concerning availability, standard warranty, and use in critical applications of Texas Instruments semiconductor products and disclaimers thereto appears at the end of this data sheet.

All trademarks are the property of their respective owners.

DESCRIPTION (CONTINUED)

The LM3671 is available in SOT-23, tiny 5-bump DSBGA and a 6-pin USON packages in leaded (PB) and lead-free (NO PB) versions. A high-switching frequency of 2 MHz (typ.) allows use of tiny surface-mount components. Only three external surface-mount components, an inductor and two ceramic capacitors, are required.

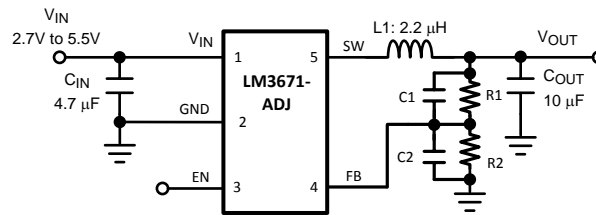

Figure 2. Typical Application Circuit for ADJ version

Connection Diagrams

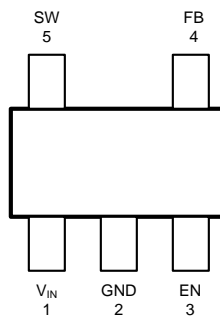

Figure 3. Top View
SOT-23 Package
See Package Number DBV (2.92 mm x 2.84 mm x 1.2 mm)

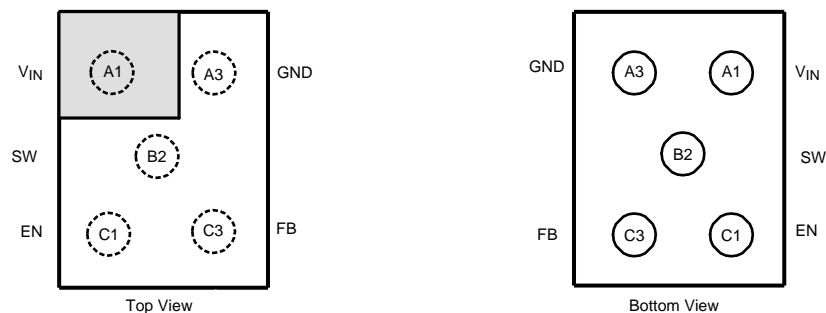

Figure 4. 5-Bump DSBGA Package
See Package Number YZR0005 (1.05 mm x 1.38 mm x 0.6 mm)

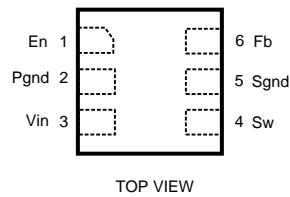

Figure 5. 6-Pin USON Package
See Package Number NKH0006B (2 mm x 2 mm x 0.6 mm)

PIN DESCRIPTIONS (SOT-23)

| Pin # | Name | Description |
|-------|-----------------|---|
| 1 | V _{IN} | Power supply input. Connect to the input filter capacitor (Figure 1). |
| 2 | GND | Ground pin. |
| 3 | EN | Enable pin. The device is in shutdown mode when voltage to this pin is <0.4V and enabled when >1.0V. Do not leave this pin floating. |
| 4 | FB | Feedback analog input. Connect directly to the output filter capacitor for fixed voltage versions. For adjustable version external resistor dividers are required (Figure 2). The internal resistor dividers are disabled for the adjustable version. |
| 5 | SW | Switching node connection to the internal PFET switch and NFET synchronous rectifier. |

PIN DESCRIPTIONS (5-Bump DSBGA)

| Pin # | Name | Description |
|-------|-----------------|---|
| A1 | V _{IN} | Power supply input. Connect to the input filter capacitor (Figure 1). |
| A3 | GND | Ground pin. |
| C1 | EN | Enable pin. The device is in shutdown mode when voltage to this pin is <0.4V and enabled when >1.0V. Do not leave this pin floating. |
| C3 | FB | Feedback analog input. Connect directly to the output filter capacitor for fixed voltage versions. For adjustable version external resistor dividers are required (Figure 2). The internal resistor dividers are disabled for the adjustable version. |
| B2 | SW | Switching node connection to the internal PFET switch and NFET synchronous rectifier. |

PIN DESCRIPTIONS (6-Pin USON)

| Pin # | Name | Description |
|-------|-----------------|---|
| 1 | EN | Enable pin. The device is in shutdown mode when voltage to this pin is <0.4V and enabled when >1.0V. Do not leave this pin floating. |
| 2 | Pgnd | Ground pin. |
| 3 | V _{IN} | Power supply input. Connect to the input filter capacitor (Figure 1). |
| 4 | SW | Switching node connection to the internal PFET switch and NFET synchronous rectifier. |
| 5 | Sgnd | Signal ground (feedback ground). |
| 6 | FB | Feedback analog input. Connect directly to the output filter capacitor for fixed voltage versions. For adjustable version external resistor dividers are required (Figure 2). The internal resistor dividers are disabled for the adjustable version. |



These devices have limited built-in ESD protection. The leads should be shorted together or the device placed in conductive foam during storage or handling to prevent electrostatic damage to the MOS gates.

ORDERING INFORMATION⁽¹⁾⁽²⁾

| Orderable | Voltage Option (V) |
|-----------------------|--------------------|
| SOT-23 Package | |
| LM3671MF-1.2 | 1.2 |
| LM3671MFX-1.2 | |
| LM3671MF-1.2/NOPB | |
| LM3671MFX-1.2/NOPB | |
| LM3671QMF-1.2 | |
| LM3671QMFX-1.2 | |
| LM3671QMF-1.2/NOPB | 1.25 |
| LM3671QMF-1.2/NOPB | |
| LM3671MF-1.25/NOPB | 1.375 |
| LM3671MFX-1.25/NOPB | |
| LM3671MF-1.375/NOPB | 1.5 |
| LM3671MFX-1.375/NOPB | |
| LM3671MF-1.5/NOPB | 1.6 |
| LM3671MFX-1.5/NOPB | |
| LM3671MF-1.6/NOPB | 1.8 |
| LM3671MFX-1.6/NOPB | |
| LM3671MF-1.8/NOPB | 1.875 |
| LM3671MFX-1.8/NOPB | |
| LM3671MF-1.875/NOPB | 2.5 |
| LM3671MFX-1.875/NOPB | |
| LM3671MF-2.5/NOPB | 2.8 |
| LM3671MFX-2.5/NOPB | |
| LM3671MF-2.8/NOPB | 3.3 |
| LM3671MFX-2.8/NOPB | |
| LM3671MF-3.3/NOPB | Adjustable |
| LM3671MFX-3.3/NOPB | |
| LM3671MF-ADJ/NOPB | |
| LM3671MFX-ADJ/NOPB | |

- (1) For the most current package and ordering information, see the Package Option Addendum at the end of this document, or see the TI web site at www.ti.com.
- (2) Package drawings, thermal data, and symbolization are available at www.ti.com/packaging.

ORDERING INFORMATION⁽¹⁾⁽²⁾ (continued)

| Orderable | Voltage Option (V) |
|----------------------|--------------------|
| DSBGA Package | |
| LM3671TL-1.2/NOPB | 1.2 |
| LM3671TLX-1.2/NOPB | |
| LM3671TL-1.25/NOPB | 1.25 |
| LM3671TLX-1.25/NOPB | |
| LM3671TL-1.5/NOPB | 1.5 |
| LM3671TLX-1.5/NOPB | |
| LM3671TL-1.8/NOPB | 1.8 |
| LM3671TLX-1.8/NOPB | |
| LM3671TL-1.875/NOPB | 1.875 |
| LM3671TLX-1.875/NOPB | |
| LM3671TL-2.5/NOPB | 2.5 |
| LM3671TLX-2.5/NOPB | |
| LM3671TL-2.8/NOPB | 2.8 |
| LM3671TLX-2.8/NOPB | |
| LM3671TL-3.3/NOPB | 3.3 |
| LM3671TLX-3.3/NOPB | |
| LM3671TL-ADJ/NOPB | Adjustable |
| LM3671TLX-ADJ/NOPB | |
| USON Package | |
| LM3671LC-1.2/NOPB | 1.2 |
| LM3671LCX-1.2/NOPB | |
| LM3671LC-1.3/NOPB | 1.3 |
| LM3671LCX-1.3/NOPB | |
| LM3671LC-1.6/NOPB | 1.6 |
| LM3671LCX-1.6/NOPB | |
| LM3671LC-1.8/NOPB | 1.8 |
| LM3671LCX-1.8/NOPB | |

ABSOLUTE MAXIMUM RATINGS⁽¹⁾⁽²⁾

| | |
|---|--|
| V _{IN} Pin: Voltage to GND | -0.2V to 6.0V |
| FB, SW, EN Pin: | (GND-0.2V) to (V _{IN} + 0.2V) |
| Continuous Power Dissipation ⁽³⁾ | Internally Limited |
| Junction Temperature (T _{J-MAX}) | +125°C |
| Storage Temperature Range | -65°C to +150°C |
| Maximum Lead Temperature (Soldering, 10 sec.) | 260°C |
| ESD Rating ⁽⁴⁾ | |
| Human Body Model | 2 kV |
| Machine Model | 200V |

- (1) Absolute Maximum Ratings indicate limits beyond which damage to the device may occur. Operating Ratings are conditions under which operation of the device is specified. Operating Ratings do not imply specified performance limits. For specified performance limits and associated test conditions, see the Electrical Characteristics tables.
- (2) **If Military/Aerospace specified devices are required, please contact the Texas Instruments Sales Office / Distributors for availability and specifications.**
- (3) Internal thermal shutdown circuitry protects the device from permanent damage. Thermal shutdown engages at T_J= 150°C (typ.) and disengages at T_J= 130°C (typ.).
- (4) The Human body model is a 100 pF capacitor discharged through a 1.5 kΩ resistor into each pin. The machine model is a 200 pF capacitor discharged directly into each pin. MIL-STD-883 3015.7

OPERATING RATINGS^{(1) (2)}

| | |
|--|-----------------|
| Input Voltage Range ⁽³⁾ | 2.7V to 5.5V |
| Recommended Load Current | 0mA to 600 mA |
| Junction Temperature (T _J) Range | -40°C to +125°C |
| Ambient Temperature (T _A) Range ⁽⁴⁾ | -40°C to +85°C |

- (1) Absolute Maximum Ratings indicate limits beyond which damage to the device may occur. Operating Ratings are conditions under which operation of the device is specified. Operating Ratings do not imply specified performance limits. For specified performance limits and associated test conditions, see the Electrical Characteristics tables.
- (2) All voltages are with respect to the potential at the GND pin.
- (3) The input voltage range recommended for ideal applications performance for the specified output voltages are given below: V_{IN} = 2.7V to 4.5V for 1.1V ≤ V_{OUT} < 1.5V V_{IN} = 2.7V to 5.5V for 1.5V ≤ V_{OUT} < 1.8V V_{IN} = (V_{OUT}+ V_{DROPOUT}) to 5.5V for 1.8V ≤ V_{OUT} ≤ 3.3V where V_{DROPOUT} = I_{LOAD} * (R_{DSON, PFET} + R_{INDUCTOR})
- (4) In Applications where high power dissipation and/or poor package resistance is present, the maximum ambient temperature may have to be derated. Maximum ambient temperature (T_{A-MAX}) is dependent on the maximum operating junction temperature (T_{J-MAX}), the maximum power dissipation of the device in the application (P_{D-MAX}) and the junction to ambient thermal resistance of the package (θ_{JA}) in the application, as given by the following equation: T_{A-MAX} = T_{J-MAX} - (θ_{JA} × P_{D-MAX}). Refer to Dissipation rating table for P_{D-MAX} values at different ambient temperatures.

THERMAL PROPERTIES

| | |
|---|---------|
| Junction-to-Ambient Thermal Resistance (θ _{JA}) (SOT-23) for 4-layer board ⁽¹⁾ | 130°C/W |
| Junction-to-Ambient Thermal Resistance (θ _{JA}) (DSBGA) for 4-layer board ⁽¹⁾ | 85°C/W |
| Junction-to-Ambient Thermal Resistance (θ _{JA}) (USON) for 4-layer board ⁽¹⁾ | 165°C/W |

- (1) Junction to ambient thermal resistance is highly application and board layout dependent. In applications where high power dissipation exists, special care must be given to thermal dissipation issues in board design. Specified value of 130 °C/W for SOT-23 is based on a 4 layer, 4" x 3", 2/1/1/2 oz. Cu board as per JEDEC standards is used.

ELECTRICAL CHARACTERISTICS⁽¹⁾⁽²⁾⁽³⁾

Limits in standard typeface are for $T_J = 25^\circ\text{C}$. Limits in **boldface** type apply over the entire junction temperature range for operation, -40°C to $+125^\circ\text{C}$. Unless otherwise noted, specifications apply to the LM3671MF/TL/LC with $V_{IN} = EN = 3.6\text{V}$

| Symbol | Parameter | Condition | Min | Typ | Max | Units |
|------------------|-------------------------------|--|-------------|--------|-------------|---------------|
| V_{IN} | Input Voltage | (4) | 2.7 | | 5.5 | V |
| V_{FB} | Feedback Voltage (Fixed) MF | PWM mode (5) | -4 | | +4 | % |
| | Feedback Voltage (Fixed) TL | | -2.5 | | +2.5 | |
| | Feedback Voltage (Fixed) LC | | -4 | | +4 | |
| | Feedback Voltage (ADJ) MF (6) | PWM mode (5) | -4 | | +4 | % |
| | Feedback Voltage (ADJ) TL | | -2.5 | | +2.5 | |
| | Line Regulation | $2.7\text{V} \leq V_{IN} \leq 5.5\text{V}$ $I_O = 10\text{mA}$ | | 0.031 | | %/V |
| | Load Regulation | $100\text{mA} \leq I_O \leq 600\text{mA}$ $V_{IN} = 3.6\text{V}$ | | 0.0013 | | %/mA |
| V_{REF} | Internal Reference Voltage | | | 0.5 | | V |
| I_{SHDN} | Shutdown Supply Current | $EN = 0\text{V}$ | | 0.01 | 1 | μA |
| I_Q | DC Bias Current into V_{IN} | No load, device is not switching (FB forced higher than programmed output voltage) | | 16 | 35 | μA |
| $R_{DS(on) (P)}$ | Pin-Pin Resistance for PFET | $V_{IN} = V_{GS} = 3.6\text{V}$ | | 380 | 500 | m Ω |
| $R_{DS(on) (N)}$ | Pin-Pin Resistance for NFET | $V_{IN} = V_{GS} = 3.6\text{V}$ | | 250 | 400 | m Ω |
| I_{LIM} | Switch Peak Current Limit | Open Loop (7) | 830 | 1020 | 1150 | mA |
| V_{IH} | Logic High Input | | 1.0 | | | V |
| V_{IL} | Logic Low Input | | | | 0.4 | V |
| I_{EN} | Enable (EN) Input Current | | | 0.01 | 1 | μA |
| F_{OSC} | Internal Oscillator Frequency | PWM Mode (5) | 1.6 | 2 | 2.6 | MHz |

- (1) All voltages are with respect to the potential at the GND pin.
- (2) Min and Max limits are specified by design, test or statistical analysis. Typical numbers are not specified, but do represent the most likely norm.
- (3) The parameters in the electrical characteristic table are tested at $V_{IN} = 3.6\text{V}$ unless otherwise specified. For performance over the input voltage range refer to datasheet curves.
- (4) The input voltage range recommended for ideal applications performance for the specified output voltages are given below: $V_{IN} = 2.7\text{V}$ to 4.5V for $1.1\text{V} \leq V_{OUT} < 1.5\text{V}$; $V_{IN} = 2.7\text{V}$ to 5.5V for $1.5\text{V} \leq V_{OUT} < 1.8\text{V}$; $V_{IN} = (V_{OUT} + V_{DROPOUT})$ to 5.5V for $1.8\text{V} \leq V_{OUT} \leq 3.3\text{V}$ where $V_{DROPOUT} = I_{LOAD} * (R_{DS(on), PFET} + R_{INDUCTOR})$
- (5) Test condition: for V_{OUT} less than 2.5V , $V_{IN} = 3.6\text{V}$; for V_{OUT} greater than or equal to 2.5V , $V_{IN} = V_{OUT} + 1\text{V}$.
- (6) ADJ version is configured to 1.5V output. For ADJ output version: $V_{IN} = 2.7\text{V}$ to 4.5V for $0.90\text{V} \leq V_{OUT} < 1.1\text{V}$; $V_{IN} = 2.7\text{V}$ to 5.5V for $1.1\text{V} \leq V_{OUT} < 3.3\text{V}$
- (7) Refer to datasheet curves for closed loop data and its variation with regards to supply voltage and temperature. Electrical Characteristic table reflects open loop data (FB=0V and current drawn from SW pin ramped up until cycle by cycle current limit is activated). Closed loop current limit is the peak inductor current measured in the application circuit by increasing output current until output voltage drops by 10%.

DISSIPATION RATING TABLE

| θ_{JA} | $T_A \leq 25^\circ\text{C}$ Power Rating | $T_A = 60^\circ\text{C}$ Power Rating | $T_A = 85^\circ\text{C}$ Power Rating |
|-------------------------------------|---|--|--|
| 130°C/W (4 layer board) SOT-23 | 770 mW | 500 mW | 310 mW |
| 85°C/W (4 layer board) 5-bump DSBGA | 1179 mW | 765 mW | 470 mW |
| 165°C/W (4 layer board) 6-pin USON | 606 mW | 394 mW | 242 mW |

BLOCK DIAGRAM

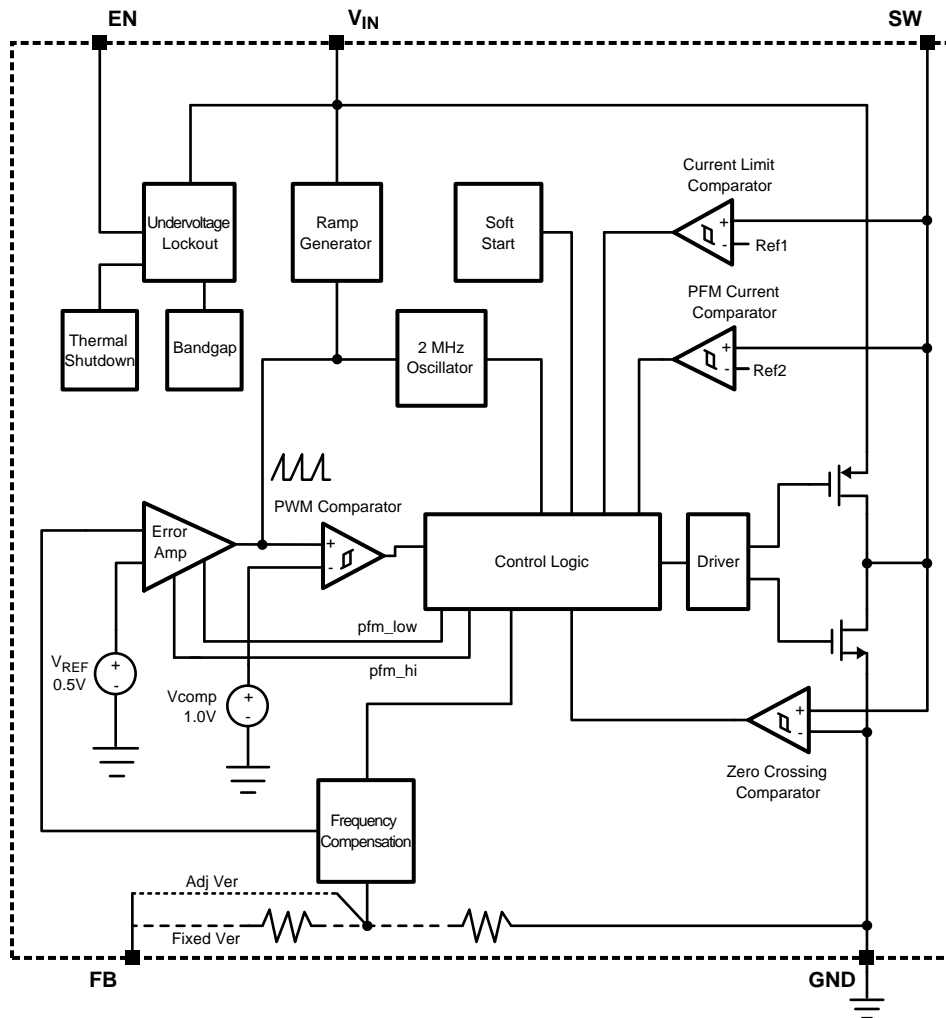

Figure 6. Simplified Functional Diagram

TYPICAL PERFORMANCE CHARACTERISTICS

LM3671MF/TL/LC, Circuit of Figure 1, $V_{IN} = 3.6V$, $V_{OUT} = 1.5V$, $T_A = 25^\circ C$, unless otherwise noted.

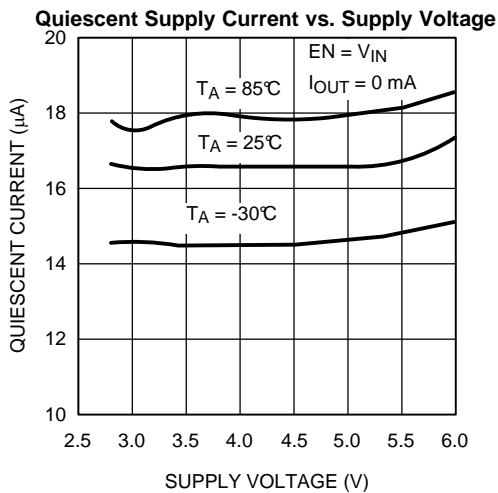

Figure 7.

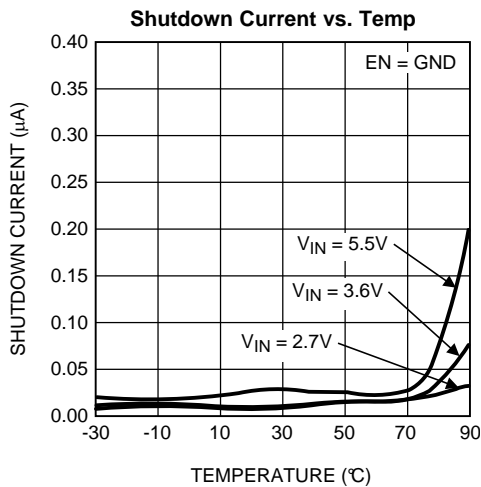

Figure 8.

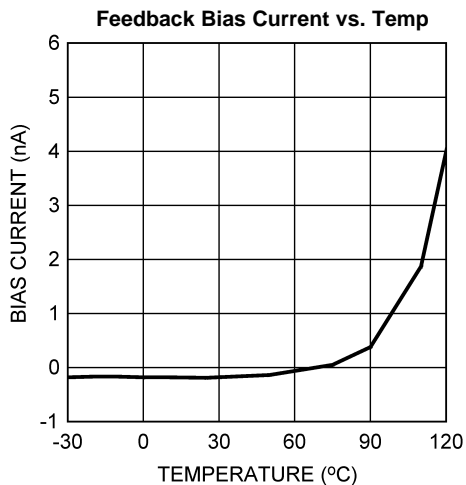

Figure 9.

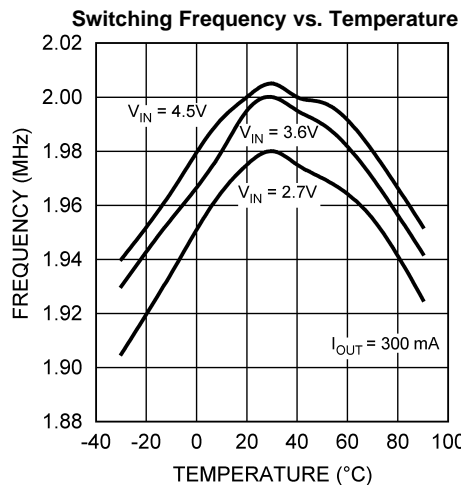

Figure 10.

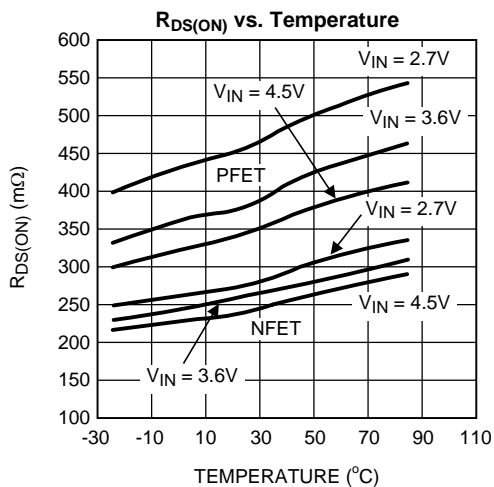

Figure 11.

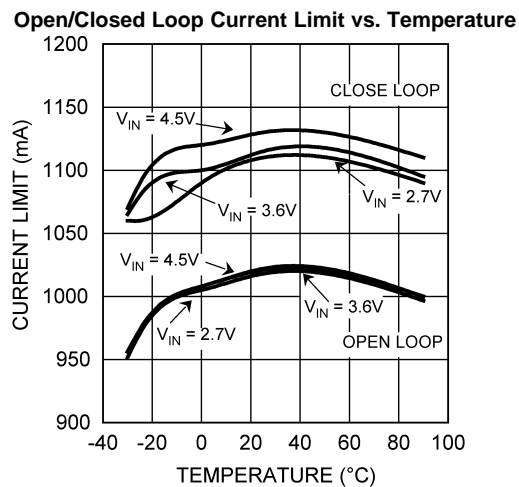

Figure 12.

TYPICAL PERFORMANCE CHARACTERISTICS (continued)

LM3671MF/TL/LC, Circuit of Figure 1, $V_{IN} = 3.6V$, $V_{OUT} = 1.5V$, $T_A = 25^\circ C$, unless otherwise noted.

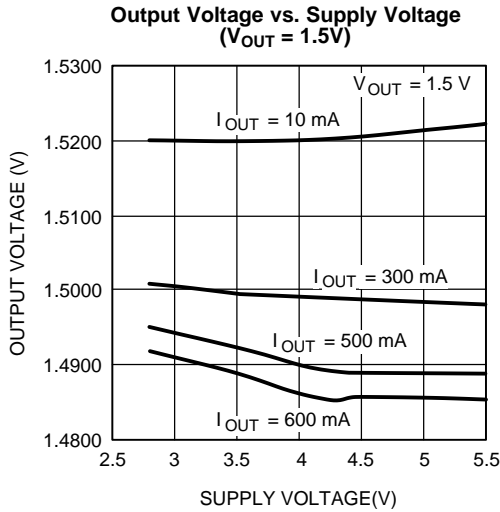

Figure 13.

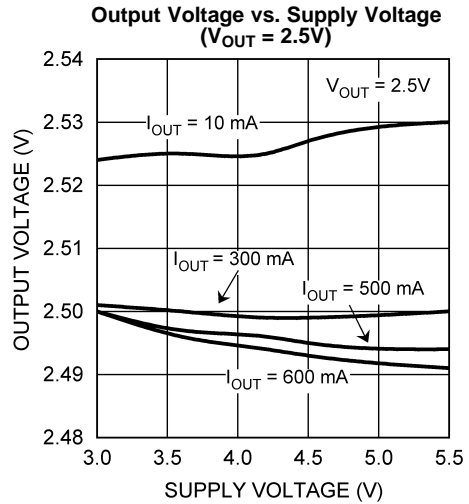

Figure 14.

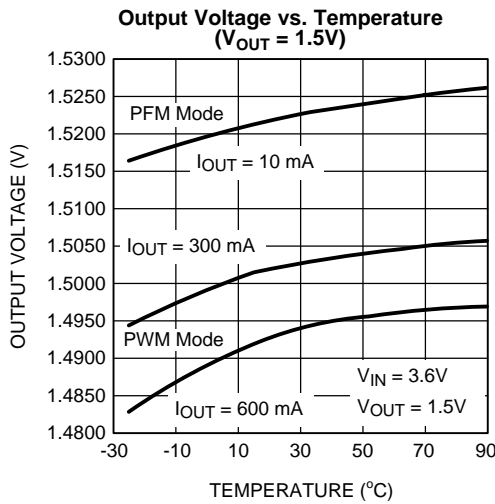

Figure 15.

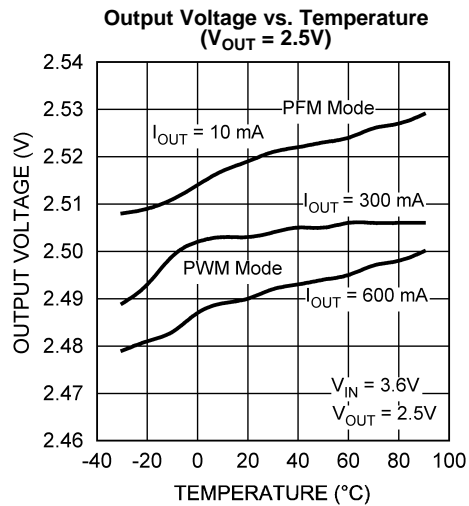

Figure 16.

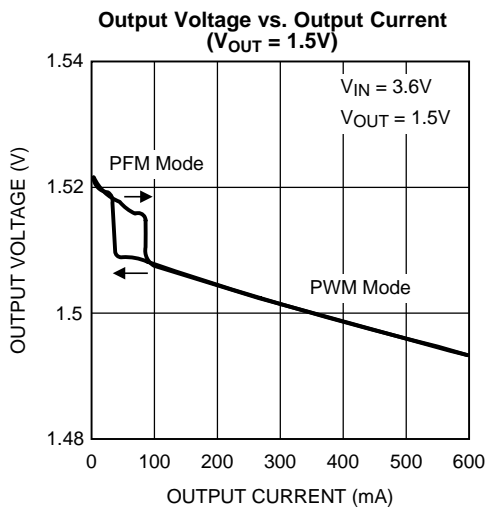

Figure 17.

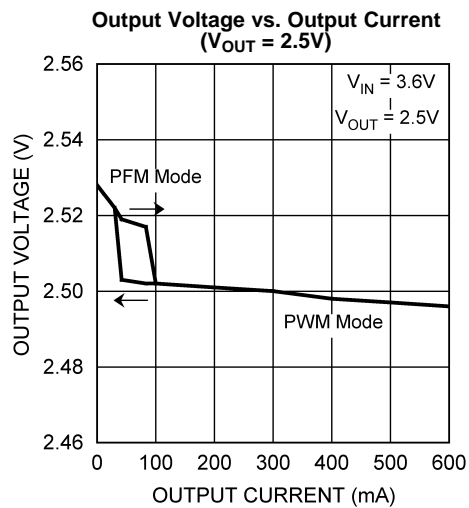

Figure 18.

TYPICAL PERFORMANCE CHARACTERISTICS (continued)

LM3671MF/TL/LC, Circuit of Figure 1, $V_{IN} = 3.6V$, $V_{OUT} = 1.5V$, $T_A = 25^\circ C$, unless otherwise noted.

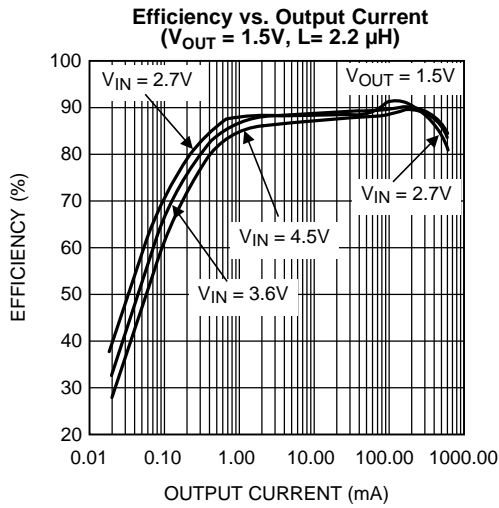

Figure 19.

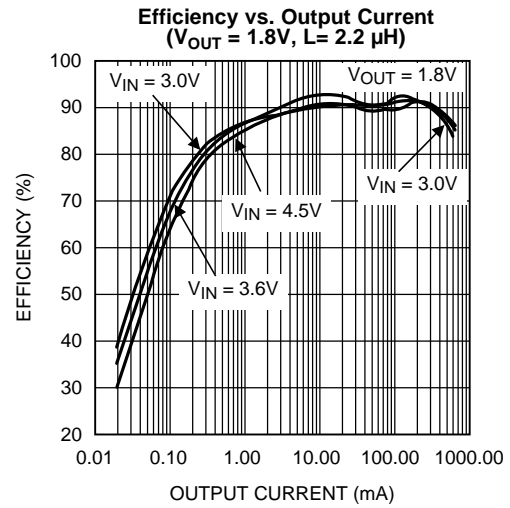

Figure 20.

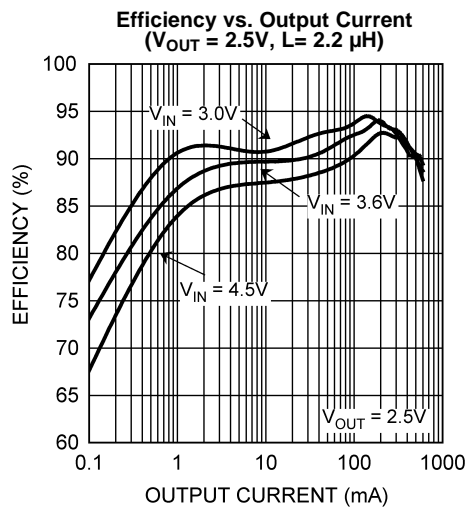

Figure 21.

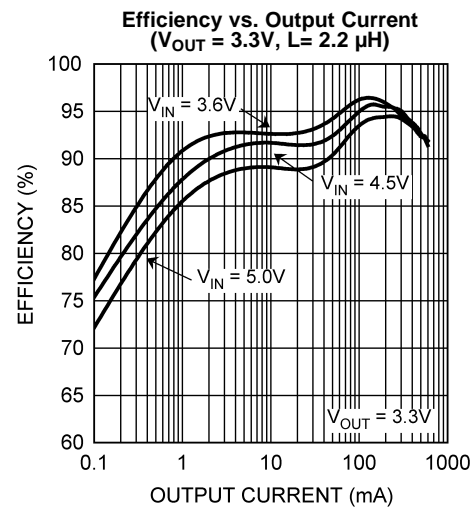

Figure 22.

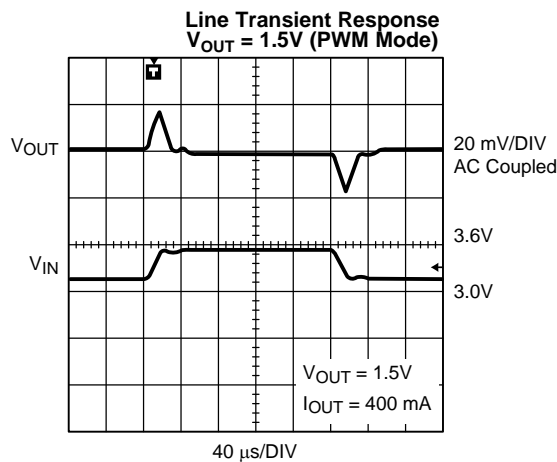

Figure 23.

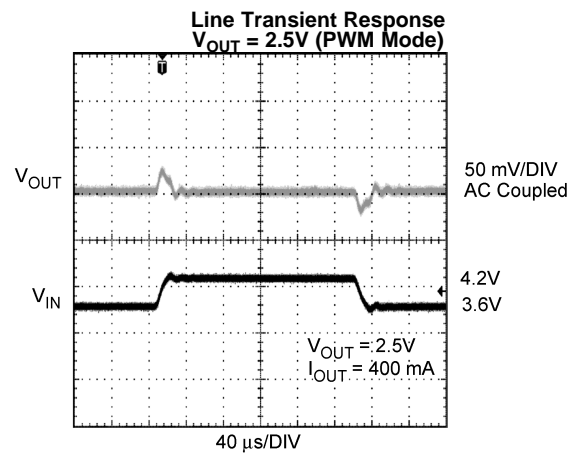

Figure 24.

TYPICAL PERFORMANCE CHARACTERISTICS (continued)

LM3671MF/TL/LC, Circuit of Figure 1, $V_{IN} = 3.6V$, $V_{OUT} = 1.5V$, $T_A = 25^\circ C$, unless otherwise noted.

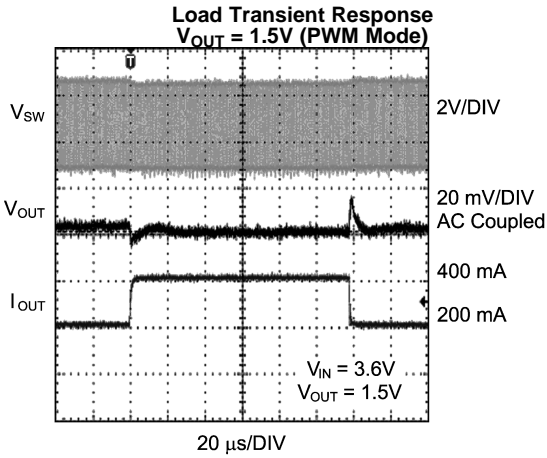

Figure 25.

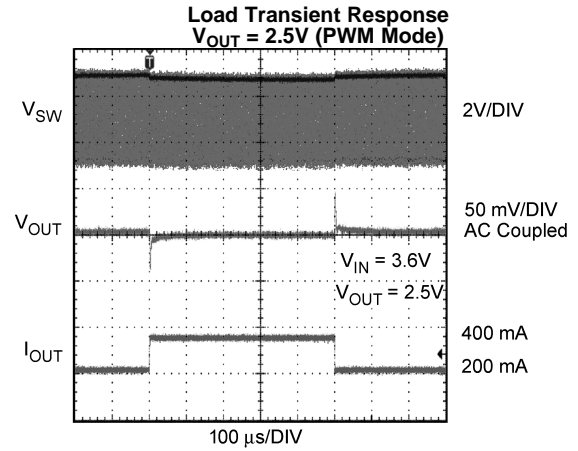

Figure 26.

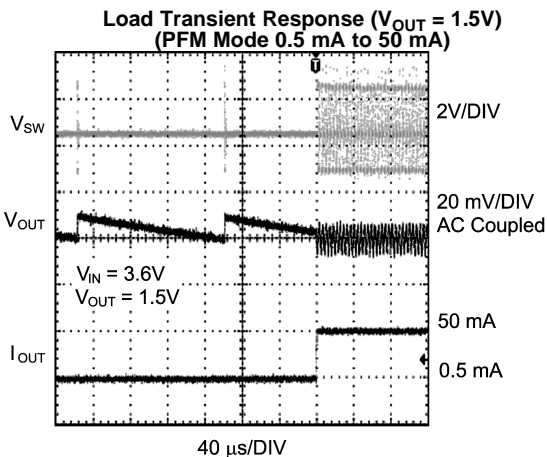

Figure 27.

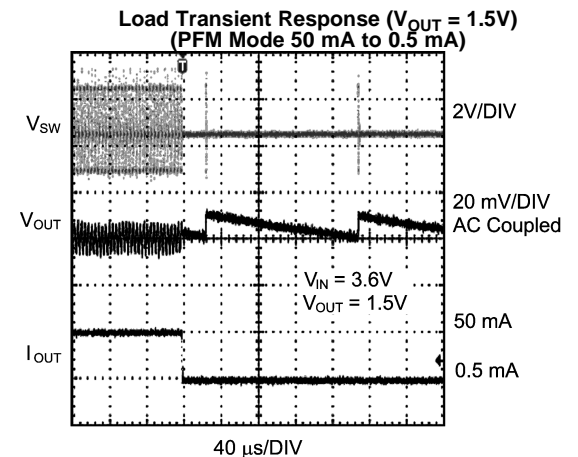

Figure 28.

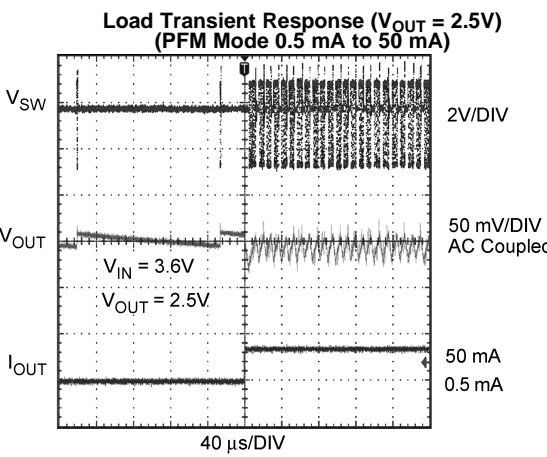

Figure 29.

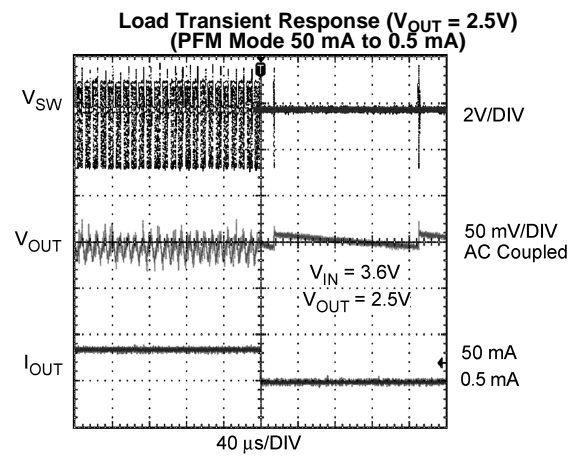

Figure 30.

TYPICAL PERFORMANCE CHARACTERISTICS (continued)

LM3671MF/TL/LC, Circuit of Figure 1, $V_{IN} = 3.6V$, $V_{OUT} = 1.5V$, $T_A = 25^\circ C$, unless otherwise noted.

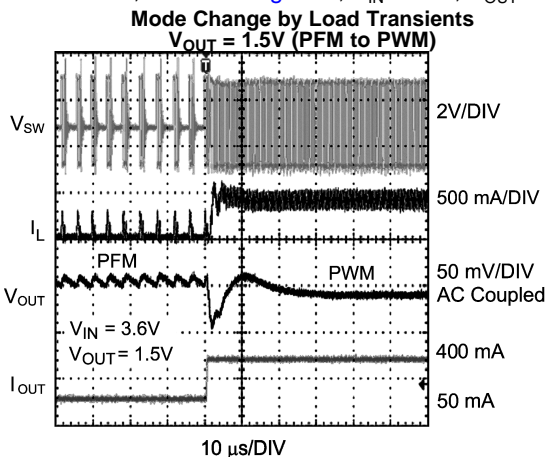

Figure 31.

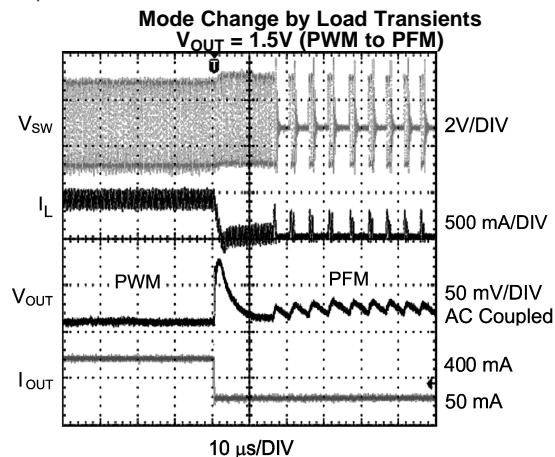

Figure 32.

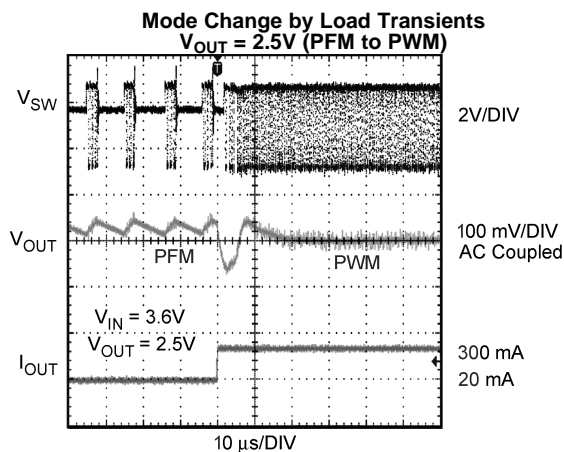

Figure 33.

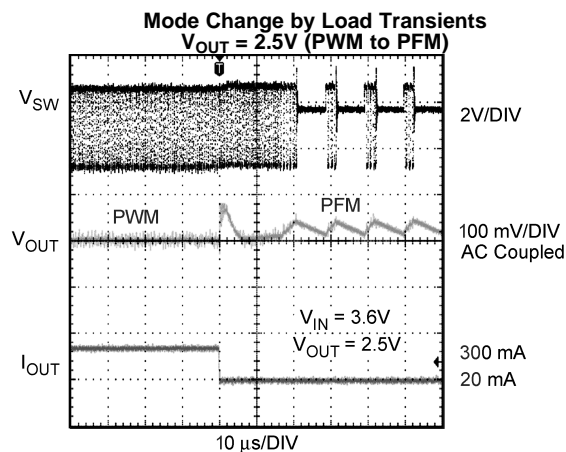

Figure 34.

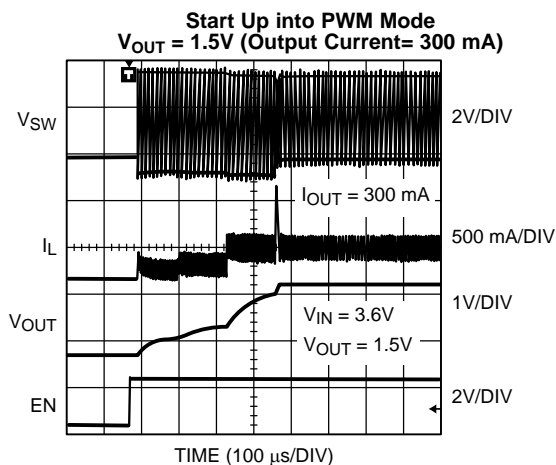

Figure 35.

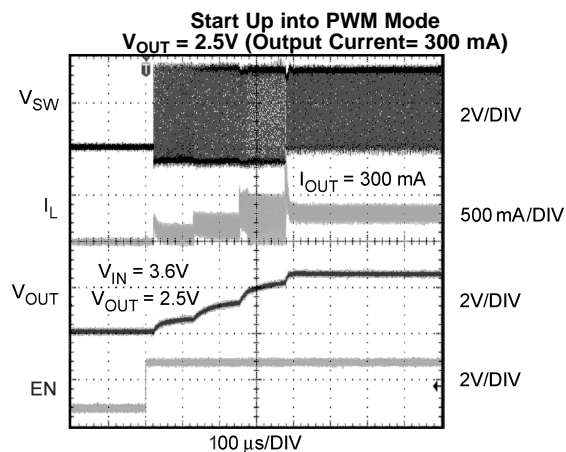

Figure 36.

TYPICAL PERFORMANCE CHARACTERISTICS (continued)

LM3671MF/TL/LC, Circuit of Figure 1, $V_{IN} = 3.6V$, $V_{OUT} = 1.5V$, $T_A = 25^\circ C$, unless otherwise noted.

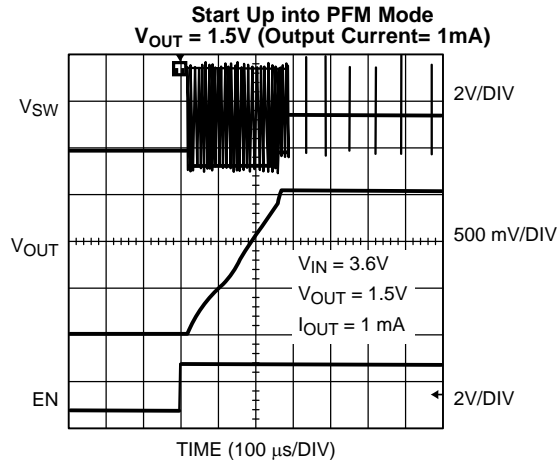

Figure 37.

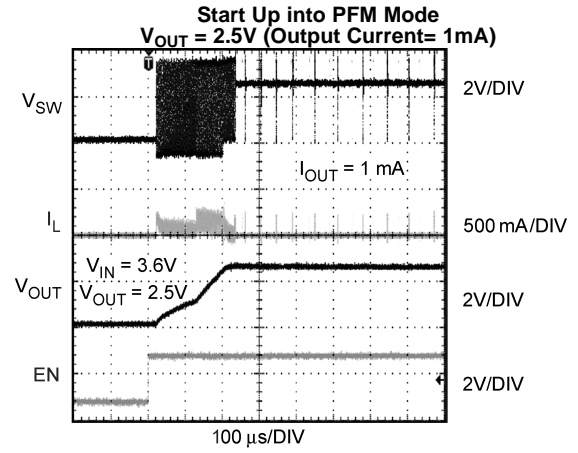

Figure 38.

OPERATION DESCRIPTION

DEVICE INFORMATION

The LM3671, a high-efficiency step-down DC-DC switching buck converter, delivers a constant voltage from a single Li-Ion battery and input voltage rails from 2.7V to 5.5V to portable devices such as cell phones and PDAs. Using a voltage mode architecture with synchronous rectification, the LM3671 has the ability to deliver up to 600 mA depending on the input voltage, output voltage, ambient temperature and the inductor chosen.

There are three modes of operation depending on the current required - PWM (Pulse Width Modulation), PFM (Pulse Frequency Modulation), and shutdown. The device operates in PWM mode at load current of approximately 80 mA or higher. Lighter load current cause the device to automatically switch into PFM for reduced current consumption ($I_Q = 16 \mu\text{A}$ typ) and a longer battery life. Shutdown mode turns off the device, offering the lowest current consumption ($I_{\text{SHUTDOWN}} = 0.01 \mu\text{A}$ typ).

Additional features include soft-start, under-voltage protection, current overload protection, and thermal shutdown protection. As shown in [Figure 1](#), only three external power components are required for implementation.

The part uses an internal reference voltage of 0.5V. It is recommended to keep the part in shutdown until the input voltage is 2.7V or higher.

CIRCUIT OPERATION

During the first portion of each switching cycle, the control block in the LM3671 turns on the internal PFET switch. This allows current to flow from the input through the inductor to the output filter capacitor and load. The inductor limits the current to a ramp with a slope of $(V_{\text{IN}} - V_{\text{OUT}})/L$, by storing energy in a magnetic field.

During the second portion of each cycle, the controller turns the PFET switch off, blocking current flow from the input, and then turns the NFET synchronous rectifier on. The inductor draws current from ground through the NFET to the output filter capacitor and load, which ramps the inductor current down with a slope of $-V_{\text{OUT}}/L$.

The output filter stores charge when the inductor current is high, and releases it when inductor current is low, smoothing the voltage across the load.

The output voltage is regulated by modulating the PFET switch on time to control the average current sent to the load. The effect is identical to sending a duty-cycle modulated rectangular wave formed by the switch and synchronous rectifier at the SW pin to a low-pass filter formed by the inductor and output filter capacitor. The output voltage is equal to the average voltage at the SW pin.

PWM OPERATION

During PWM operation the converter operates as a voltage-mode controller with input voltage feed forward. This allows the converter to achieve good load and line regulation. The DC gain of the power stage is proportional to the input voltage. To eliminate this dependence, feed forward inversely proportional to the input voltage is introduced.

While in PWM mode, the output voltage is regulated by switching at a constant frequency and then modulating the energy per cycle to control power to the load. At the beginning of each clock cycle the PFET switch is turned on and the inductor current ramps up until the comparator trips and the control logic turns off the switch. The current limit comparator can also turn off the switch in case the current limit of the PFET is exceeded. Then the NFET switch is turned on and the inductor current ramps down. The next cycle is initiated by the clock turning off the NFET and turning on the PFET.

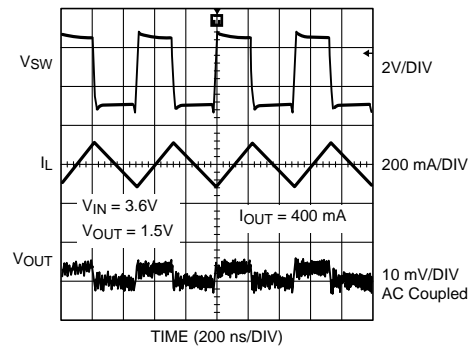

Figure 39. Typical PWM Operation

Internal Synchronous Rectification

While in PWM mode, the LM3671 uses an internal NFET as a synchronous rectifier to reduce rectifier forward voltage drop and associated power loss. Synchronous rectification provides a significant improvement in efficiency whenever the output voltage is relatively low compared to the voltage drop across an ordinary rectifier diode.

Current Limiting

A current limit feature allows the LM3671 to protect itself and external components during overload conditions. PWM mode implements current limiting using an internal comparator that trips at 1020 mA (typ.). If the output is shorted to ground the device enters a timed current limit mode where the NFET is turned on for a longer duration until the inductor current falls below a low threshold. This allows the inductor current more time to decay, thereby preventing runaway.

PFM OPERATION

At very light load, the converter enters PFM mode and operates with reduced switching frequency and supply current to maintain high efficiency.

The part automatically transitions into PFM mode when either of two conditions occurs for a duration of 32 or more clock cycles:

- A. The NFET current reaches zero.
- B. The peak PMOS switch current drops below the I_{MODE} level, (Typically $I_{MODE} < 30 \text{ mA} + V_{IN}/42\Omega$).

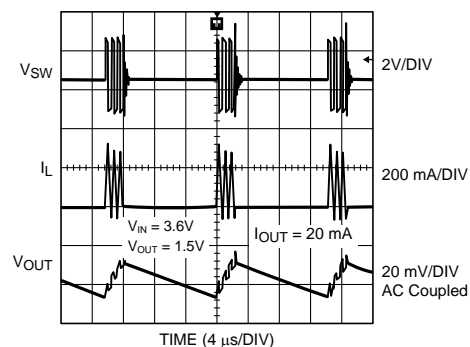

Figure 40. Typical PFM Operation

During PFM operation, the converter positions the output voltage slightly higher than the nominal output voltage during PWM operation, allowing additional headroom for voltage drop during a load transient from light to heavy load. The PFM comparators sense the output voltage via the feedback pin and control the switching of the output FETs such that the output voltage ramps between ~0.6% and ~1.7% above the nominal PWM output voltage. If the output voltage is below the 'high' PFM comparator threshold, the PMOS power switch is turned on. It remains on until the output voltage reaches the 'high' PFM threshold or the peak current exceeds the I_{PFM} level set for PFM mode. The typical peak current in PFM mode is: $I_{PFM} = 112 \text{ mA} + V_{IN}/27\Omega$.

Once the PMOS power switch is turned off, the NMOS power switch is turned on until the inductor current ramps to zero. When the NMOS zero-current condition is detected, the NMOS power switch is turned off. If the output voltage is below the 'high' PFM comparator threshold (see Figure 41), the PMOS switch is again turned on and the cycle is repeated until the output reaches the desired level. Once the output reaches the 'high' PFM threshold, the NMOS switch is turned on briefly to ramp the inductor current to zero and then both output switches are turned off and the part enters an extremely low power mode. Quiescent supply current during this 'sleep' mode is 16 μA (typ.), which allows the part to achieve high efficiency under extremely light load conditions.

If the load current should increase during PFM mode (see Figure 41) causing the output voltage to fall below the 'low2' PFM threshold, the part will automatically transition into fixed-frequency PWM mode. When $V_{IN} = 2.7\text{V}$ the part transitions from PWM to PFM mode at ~35 mA output current and from PFM to PWM mode at ~85 mA, when $V_{IN} = 3.6\text{V}$, PWM to PFM transition happens at ~50 mA and PFM to PWM transition happens at ~100 mA, when $V_{IN} = 4.5\text{V}$, PWM to PFM transition happens at ~65 mA and PFM to PWM transition happens at ~115 mA.

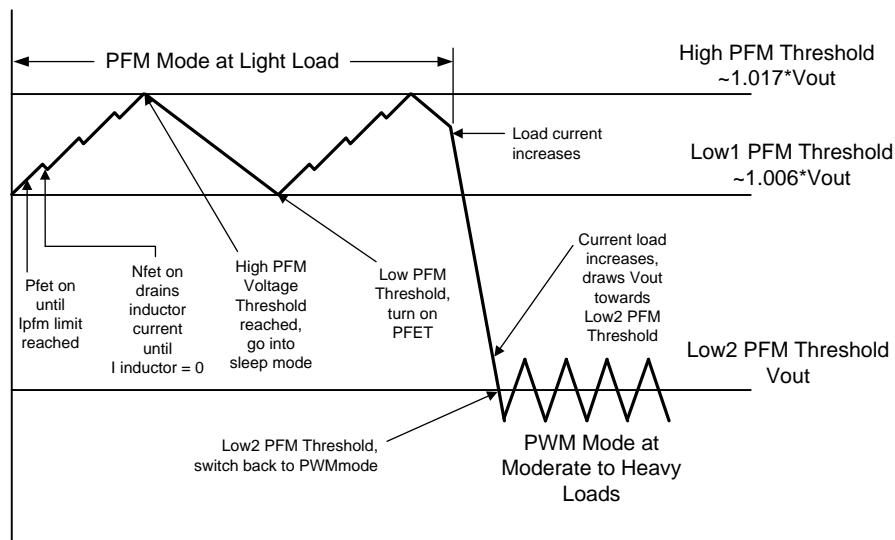

Figure 41. Operation in PFM Mode and Transfer to PWM Mode

SHUTDOWN MODE

Setting the EN input pin low ($<0.4\text{V}$) places the LM3671 in shutdown mode. During shutdown the PFET switch, NFET switch, reference, control and bias circuitry of the LM3671 are turned off. Setting EN high ($>1.0\text{V}$) enables normal operation. It is recommended to set EN pin low to turn off the LM3671 during system power up and undervoltage conditions when the supply is less than 2.7V. Do not leave the EN pin floating.

SOFT START

The LM3671 has a soft-start circuit that limits in-rush current during startup. During startup the switch current limit is increased in steps. Soft start is activated only if EN goes from logic low to logic high after V_{in} reaches 2.7V. Soft start is implemented by increasing switch current limit in steps of 70 mA, 140 mA, 280 mA and 1020 mA (typical switch current limit). The startup time thereby depends on the output capacitor and load current demanded at startup. Typical startup times with a 10 μF output capacitor and 300 mA load is 400 μs and with 1mA load is 275 μs .

LDO - LOW DROPOUT OPERATION

The LM3671-ADJ can operate at 100% duty cycle (no switching; PMOS switch completely on) for low dropout support of the output voltage. In this way the output voltage will be controlled down to the lowest possible input voltage. When the device operates near 100% duty cycle, output voltage ripple is approximately 25 mV.

The minimum input voltage needed to support the output voltage is

$$V_{IN, MIN} = I_{LOAD} * (R_{DSON, PFET} + R_{INDUCTOR}) + V_{OUT}$$

where

- I_{LOAD} : Load current
- $R_{DSON, PFET}$: Drain to source resistance of PFET switch in the triode region
- $R_{INDUCTOR}$: Inductor resistance

(1)

APPLICATION INFORMATION

OUTPUT VOLTAGE SELECTION FOR LM3671-ADJ

The output voltage of the adjustable parts can be programmed through the resistor network connected from V_{OUT} to FB, then to GND. V_{OUT} is adjusted to make the voltage at FB equal to 0.5V. The resistor from FB to GND (R_2) should be 200 k Ω to keep the current drawn through this network well below the 16 μ A quiescent current level (PFM mode) but large enough that it is not susceptible to noise. If R_2 is 200 k Ω , and V_{FB} is 0.5V, the current through the resistor feedback network will be 2.5 μ A. The output voltage of the adjustable parts ranges from 1.1V to 3.3V.

The formula for output voltage selection is:

$$V_{OUT} = V_{FB} * \left(1 + \frac{R_1}{R_2}\right)$$

where

- V_{OUT} : output voltage (volts)
 - V_{FB} : feedback voltage = 0.5V
 - R_1 : feedback resistor from V_{OUT} to FB
 - R_2 : feedback resistor from FB to GND
- (2)

For any output voltage greater than or equal to 1.1V, a zero must be added around 45 kHz for stability. The formula for calculation of C_1 is:

$$C_1 = \frac{1}{(2 * \pi * R_1 * 45 \text{ kHz})}$$
(3)

For output voltages higher than 2.5V, a pole must be placed at 45 kHz as well. If the pole and zero are at the same frequency the formula for calculation of C_2 is:

$$C_2 = \frac{1}{(2 * \pi * R_2 * 45 \text{ kHz})}$$
(4)

The formula for location of zero and pole frequency created by adding C_1 and C_2 is given below. By adding C_1 , a zero as well as a higher frequency pole is introduced.

$$F_z = \frac{1}{(2 * \pi * R_1 * C_1)}$$
(5)

$$F_p = \frac{1}{2 * \pi * (R_1 || R_2) * (C_1 + C_2)}$$
(6)

See the "LM3671-ADJ configurations for various V_{OUT} " table.

**Table 1. LM3671-ADJ Configurations For Various V_{OUT} (Circuit of Figure 2)
(Refer to Note 11 for V_{IN} requirements)**

| $V_{OUT}(V)$ | $R_1(k\Omega)$ | $R_2(k\Omega)$ | $C_1(pF)$ | $C_2(pF)$ | $L(\mu H)$ | $C_{IN}(\mu F)$ | $C_{OUT}(\mu F)$ |
|--------------|----------------|----------------|-----------|-----------|------------|-----------------|------------------|
| 0.90 | 160 | 200 | 22 | none | 2.2 | 4.7 | 10 |
| 1.1 | 240 | 200 | 15 | none | 2.2 | 4.7 | 10 |
| 1.2 | 280 | 200 | 12 | none | 2.2 | 4.7 | 10 |
| 1.3 | 320 | 200 | 12 | none | 2.2 | 4.7 | 10 |
| 1.5 | 357 | 178 | 10 | none | 2.2 | 4.7 | 10 |
| 1.6 | 442 | 200 | 8.2 | none | 2.2 | 4.7 | 10 |
| 1.7 | 432 | 178 | 8.2 | none | 2.2 | 4.7 | 10 |
| 1.8 | 464 | 178 | 8.2 | none | 2.2 | 4.7 | 10 |
| 1.875 | 523 | 191 | 6.8 | none | 2.2 | 4.7 | 10 |
| 2.5 | 402 | 100 | 8.2 | none | 2.2 | 4.7 | 10 |
| 2.8 | 464 | 100 | 8.2 | 33 | 2.2 | 4.7 | 10 |
| 3.3 | 562 | 100 | 6.8 | 33 | 2.2 | 4.7 | 10 |

INDUCTOR SELECTION

There are two main considerations when choosing an inductor; the inductor should not saturate, and the inductor current ripple should be small enough to achieve the desired output voltage ripple. Different saturation current rating specifications are followed by different manufacturers so attention must be given to details. Saturation current ratings are typically specified at 25°C. However, ratings at the maximum ambient temperature of application should be requested from the manufacturer. **The minimum value of inductance to specify good performance is 1.76 µH at I_{LIM} (typ.) dc current over the ambient temperature range.** Shielded inductors radiate less noise and should be preferred.

There are two methods to choose the inductor saturation current rating.

Method 1:

The saturation current should be greater than the sum of the maximum load current and the worst case average to peak inductor current. This can be written as

$$I_{SAT} > I_{OUTMAX} + I_{RIPPLE}$$

$$\text{where } I_{RIPPLE} = \left(\frac{V_{IN} - V_{OUT}}{2 * L} \right) * \left(\frac{V_{OUT}}{V_{IN}} \right) * \left(\frac{1}{f} \right)$$

where

- I_{RIPPLE}: average to peak inductor current
- I_{OUTMAX}: maximum load current (600 mA)
- V_{IN}: maximum input voltage in application
- L : min inductor value including worst case tolerances (30% drop can be considered for method 1)
- f : minimum switching frequency (1.6 Mhz)
- V_{OUT}: output voltage

(7)

Method 2:

A more conservative and recommended approach is to choose an inductor that has a saturation current rating greater than the maximum current limit of 1150mA.

A 2.2 µH inductor with a saturation current rating of at least 1150 mA is recommended for most applications. The inductor's resistance should be less than 0.3Ω for good efficiency. [Table 2](#) lists suggested inductors and suppliers. For low-cost applications, an unshielded bobbin inductor could be considered. For noise critical applications, a toroidal or shielded-bobbin inductor should be used. A good practice is to lay out the board with overlapping footprints of both types for design flexibility. This allows substitution of a low-noise shielded inductor, in the event that noise from low-cost bobbin models is unacceptable.

INPUT CAPACITOR SELECTION

A ceramic input capacitor of 4.7 µF, 6.3V is sufficient for most applications. Place the input capacitor as close as possible to the V_{IN} pin of the device. A larger value may be used for improved input voltage filtering. Use X7R or X5R types; do not use Y5V. DC bias characteristics of ceramic capacitors must be considered when selecting case sizes like 0805 and 0603. **The minimum input capacitance to specify good performance is 2.2µF at 3V dc bias; 1.5µF at 5V dc bias including tolerances and over ambient temperature range.** The input filter capacitor supplies current to the PFET switch of the LM3671 in the first half of each cycle and reduces voltage ripple imposed on the input power source. A ceramic capacitor's low ESR provides the best noise filtering of the input voltage spikes due to this rapidly changing current. Select a capacitor with sufficient ripple current rating. The input current ripple can be calculated as:

$$I_{RMS} = I_{OUTMAX} * \sqrt{\frac{V_{OUT}}{V_{IN}} * \left(1 - \frac{V_{OUT}}{V_{IN}} + \frac{r^2}{12} \right)}$$

$$r = \frac{(V_{IN} - V_{OUT}) * V_{OUT}}{L * f * I_{OUTMAX} * V_{IN}}$$

The worst case is when V_{IN} = 2 * V_{OUT}

(8)

Table 2. Suggested Inductors and Their Suppliers

| Model | Vendor | Dimensions LxWxH(mm) | D.C.R (max) |
|------------------|-----------|----------------------|-------------|
| DO3314-222MX | Coilcraft | 3.3 x 3.3 x 1.4 | 200 mΩ |
| LPO3310-222MX | Coilcraft | 3.3 x 3.3 x 1.0 | 150 mΩ |
| ELL5GM2R2N | Panasonic | 5.2 x 5.2 x 1.5 | 53 mΩ |
| CDRH2D14NP-2R2NC | Sumida | 3.2 x 3.2 x 1.55 | 94 mΩ |

OUTPUT CAPACITOR SELECTION

A ceramic output capacitor of 10 μF, 6.3V is sufficient for most applications. Use X7R or X5R types; do not use Y5V. DC bias characteristics of ceramic capacitors must be considered when selecting case sizes like 0805 and 0603. DC bias characteristics vary from manufacturer to manufacturer and dc bias curves should be requested from them as part of the capacitor selection process.

The minimum output capacitance to specify good performance is 5.75 μF at 1.8V dc bias including tolerances and over ambient temperature range. The output filter capacitor smoothes out current flow from the inductor to the load, helps maintain a steady output voltage during transient load changes and reduces output voltage ripple. These capacitors must be selected with sufficient capacitance and sufficiently low ESR to perform these functions.

The output voltage ripple is caused by the charging and discharging of the output capacitor and by the R_{ESR} and can be calculated as:

Voltage peak-to-peak ripple due to capacitance can be expressed as follow:

$$V_{PP-C} = \frac{I_{RIPPLE}}{4 * f * C} \quad (9)$$

Voltage peak-to-peak ripple due to ESR can be expressed as follow:

$$V_{PP-ESR} = (2 * I_{RIPPLE}) * R_{ESR}$$

Because these two components are out of phase the rms (root mean squared) value can be used to get an approximate value of peak-to-peak ripple.

The peak-to-peak ripple voltage, rms value can be expressed as follow:

$$V_{PP-RMS} = \sqrt{V_{PP-C}^2 + V_{PP-ESR}^2} \quad (10)$$

Note that the output voltage ripple is dependent on the inductor current ripple and the equivalent series resistance of the output capacitor (R_{ESR}).

The R_{ESR} is frequency dependent (as well as temperature dependent); make sure the value used for calculations is at the switching frequency of the part.

Table 3. Suggested Capacitors and Their Suppliers

| Model | Type | Vendor | Voltage Rating | Case Size Inch (mm) |
|----------------------------------|--------------|-------------|----------------|---------------------|
| 4.7 μF for C_{IN} | | | | |
| C2012X5R0J475K | Ceramic, X5R | TDK | 6.3V | 0805 (2012) |
| JMK212BJ475K | Ceramic, X5R | Taiyo-Yuden | 6.3V | 0805 (2012) |
| GRM21BR60J475K | Ceramic, X5R | Murata | 6.3V | 0805 (2012) |
| C1608X5R0J475K | Ceramic, X5R | TDK | 6.3V | 0603 (1608) |
| 10 μF for C_{OUT} | | | | |
| GRM21BR60J106K | Ceramic, X5R | Murata | 6.3V | 0805 (2012) |
| JMK212BJ106K | Ceramic, X5R | Taiyo-Yuden | 6.3V | 0805 (2012) |
| C2012X5R0J106K | Ceramic, X5R | TDK | 6.3V | 0805 (2012) |
| C1608X5R0J106K | Ceramic, X5R | TDK | 6.3V | 0603 (1608) |

DSBGA PACKAGE ASSEMBLY AND USE

Use of the DSBGA package requires specialized board layout, precision mounting and careful re-flow techniques, as detailed in Texas Instruments Application Note AN-1112 (Literature Number [SNVA009](#)). Refer to the section "Surface Mount Technology (DSBGA) Assembly Considerations". For best results in assembly, alignment ordinals on the PC board should be used to facilitate placement of the device. The pad style used with DSBGA package must be the NSMD (non-solder mask defined) type. This means that the solder-mask opening is larger than the pad size. This prevents a lip that otherwise forms if the solder-mask and pad overlap, from holding the device off the surface of the board and interfering with mounting. See Application Note AN-1112 (Literature Number [SNVA009](#)) for specific instructions how to do this. The 5-bump package used for LM3671 has 300 micron solder balls and requires 10.82 mils pads for mounting on the circuit board. The trace to each pad should enter the pad with a 90° entry angle to prevent debris from being caught in deep corners. Initially, the trace to each pad should be 7 mil wide, for a section approximately 7 mil long or longer, as a thermal relief. Then each trace should neck up or down to its optimal width. The important criteria is symmetry. This ensures the solder bumps on the LM3671 re-flow evenly and that the device solders level to the board. In particular, special attention must be paid to the pads for bumps A1 and A3, because V_{IN} and GND are typically connected to large copper planes, inadequate thermal relief can result in late or inadequate re-flow of these bumps.

The DSBGA package is optimized for the smallest possible size in applications with red or infrared opaque cases. Because the DSBGA package lacks the plastic encapsulation characteristic of larger devices, it is vulnerable to light. Backside metallization and/or epoxy coating, along with front-side shading by the printed circuit board, reduce this sensitivity. However, the package has exposed die edges. In particular, DSBGA devices are sensitive to light, in the red and infrared range, shining on the package's exposed die edges.

BOARD LAYOUT CONSIDERATIONS

PC board layout is an important part of DC-DC converter design. Poor board layout can disrupt the performance of a DC-DC converter and surrounding circuitry by contributing to EMI, ground bounce, and resistive voltage loss in the traces. These can send erroneous signals to the DC-DC converter IC, resulting in poor regulation or instability.

Good layout for the LM3671 can be implemented by following a few simple design rules below. Refer to [Figure 42](#) for top layer board layout.

1. *Place the LM3671, inductor and filter capacitors close together and make the traces short.* The traces between these components carry relatively high switching currents and act as antennas. Following this rule reduces radiated noise. Special care must be given to place the input filter capacitor very close to the V_{IN} and GND pin.
2. *Arrange the components so that the switching current loops curl in the same direction.* During the first half of each cycle, current flows from the input filter capacitor through the LM3671 and inductor to the output filter capacitor and back through ground, forming a current loop. In the second half of each cycle, current is pulled up from ground through the LM3671 by the inductor to the output filter capacitor and then back through ground forming a second current loop. Routing these loops so the current curls in the same direction prevents magnetic field reversal between the two half-cycles and reduces radiated noise.
3. *Connect the ground pins of the LM3671 and filter capacitors together using generous component-side copper fill as a pseudo-ground plane. Then, connect this to the ground-plane (if one is used) with several vias.* This reduces ground-plane noise by preventing the switching currents from circulating through the ground plane. It also reduces ground bounce at the LM3671 by giving it a low-impedance ground connection.
4. *Use wide traces between the power components and for power connections to the DC-DC converter circuit.* This reduces voltage errors caused by resistive losses across the traces.
5. *Route noise sensitive traces, such as the voltage feedback path, away from noisy traces between the power components.* The voltage feedback trace must remain close to the LM3671 circuit and should be direct but should be routed opposite to noisy components. This reduces EMI radiated onto the DC-DC converter's own voltage feedback trace. A good approach is to route the feedback trace on another layer and to have a ground plane between the top layer and layer on which the feedback trace is routed. In the same manner for the adjustable part it is desired to have the feedback dividers on the bottom layer.
6. *Place noise sensitive circuitry, such as radio IF blocks, away from the DC-DC converter, CMOS digital blocks and other noisy circuitry.* Interference with noise-sensitive circuitry in the system can be reduced through distance.

In mobile phones, for example, a common practice is to place the DC-DC converter on one corner of the board, arrange the CMOS digital circuitry around it (since this also generates noise), and then place sensitive preamplifiers and IF stages on the diagonally opposing corner. Often, the sensitive circuitry is shielded with a metal pan and power to it is post-regulated to reduce conducted noise, using low-dropout linear regulators.

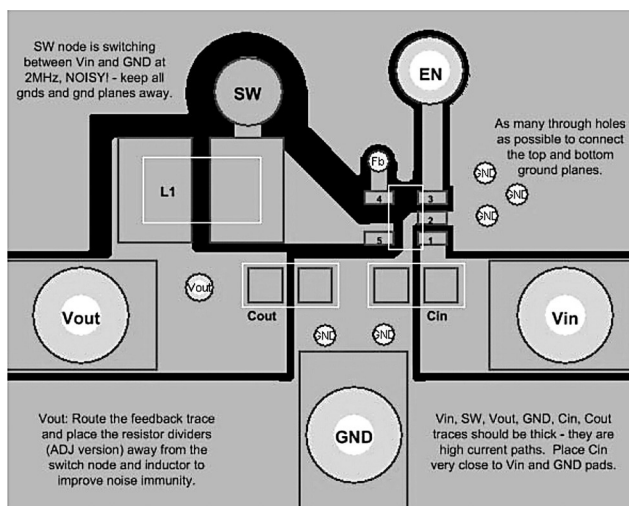

Figure 42. Top Layer Board Layout For SOT-23

REVISION HISTORY

| Changes from Revision O (April 2013) to Revision P | Page |
|--|--------------------|
| • Changed layout of National Data Sheet to TI format | 23 |

PACKAGING INFORMATION

| Orderable Device | Status (1) | Package Type | Package Drawing | Pins | Package Qty | Eco Plan (2) | Lead/Ball Finish | MSL Peak Temp (3) | Op Temp (°C) | Top-Side Markings (4) | Samples |
|---------------------|---------------|--------------|-----------------|------|-------------|-------------------------|------------------|----------------------|--------------|--------------------------|-------------------------|
| LM3671LC-1.2/NOPB | ACTIVE | USON | NKH | 6 | 1000 | Green (RoHS & no Sb/Br) | CU NIPDAU | Level-1-260C-UNLIM | | S39 | Samples |
| LM3671LC-1.3/NOPB | ACTIVE | USON | NKH | 6 | 1000 | Green (RoHS & no Sb/Br) | CU NIPDAU | Level-1-260C-UNLIM | | S40 | Samples |
| LM3671LC-1.6/NOPB | ACTIVE | USON | NKH | 6 | 1000 | Green (RoHS & no Sb/Br) | CU NIPDAU | Level-1-260C-UNLIM | | S41 | Samples |
| LM3671LC-1.8/NOPB | ACTIVE | USON | NKH | 6 | 1000 | Green (RoHS & no Sb/Br) | CU NIPDAU | Level-1-260C-UNLIM | | S42 | Samples |
| LM3671LCX-1.2/NOPB | ACTIVE | USON | NKH | 6 | 4500 | Green (RoHS & no Sb/Br) | CU NIPDAU | Level-1-260C-UNLIM | | S39 | Samples |
| LM3671LCX-1.3/NOPB | ACTIVE | USON | NKH | 6 | 4500 | Green (RoHS & no Sb/Br) | CU NIPDAU | Level-1-260C-UNLIM | | S40 | Samples |
| LM3671LCX-1.6/NOPB | ACTIVE | USON | NKH | 6 | 4500 | Green (RoHS & no Sb/Br) | CU NIPDAU | Level-1-260C-UNLIM | | S41 | Samples |
| LM3671LCX-1.8/NOPB | ACTIVE | USON | NKH | 6 | 4500 | Green (RoHS & no Sb/Br) | CU NIPDAU | Level-1-260C-UNLIM | | S42 | Samples |
| LM3671MF-1.2 | ACTIVE | SOT-23 | DBV | 5 | 1000 | TBD | Call TI | Call TI | -30 to 85 | SBPB | Samples |
| LM3671MF-1.2/NOPB | ACTIVE | SOT-23 | DBV | 5 | 1000 | Green (RoHS & no Sb/Br) | CU SN | Level-1-260C-UNLIM | -30 to 85 | SBPB | Samples |
| LM3671MF-1.25 | ACTIVE | SOT-23 | DBV | 5 | 1000 | TBD | Call TI | Call TI | -30 to 85 | SDRB | Samples |
| LM3671MF-1.25/NOPB | ACTIVE | SOT-23 | DBV | 5 | 1000 | Green (RoHS & no Sb/Br) | CU SN | Level-1-260C-UNLIM | -30 to 85 | SDRB | Samples |
| LM3671MF-1.375 | ACTIVE | SOT-23 | DBV | 5 | 1000 | TBD | Call TI | Call TI | -30 to 85 | SEDB | Samples |
| LM3671MF-1.375/NOPB | ACTIVE | SOT-23 | DBV | 5 | 1000 | Green (RoHS & no Sb/Br) | CU SN | Level-1-260C-UNLIM | -30 to 85 | SEDB | Samples |
| LM3671MF-1.5 | ACTIVE | SOT-23 | DBV | 5 | 1000 | TBD | Call TI | Call TI | -30 to 85 | SBRB | Samples |
| LM3671MF-1.5/NOPB | ACTIVE | SOT-23 | DBV | 5 | 1000 | Green (RoHS & no Sb/Br) | CU SN | Level-1-260C-UNLIM | -30 to 85 | SBRB | Samples |
| LM3671MF-1.6 | ACTIVE | SOT-23 | DBV | 5 | 1000 | TBD | Call TI | Call TI | -30 to 85 | SDUB | Samples |
| LM3671MF-1.6/NOPB | ACTIVE | SOT-23 | DBV | 5 | 1000 | Green (RoHS & no Sb/Br) | CU SN | Level-1-260C-UNLIM | -30 to 85 | SDUB | Samples |

| Orderable Device | Status (1) | Package Type | Package Drawing | Pins | Package Qty | Eco Plan (2) | Lead/Ball Finish | MSL Peak Temp (3) | Op Temp (°C) | Top-Side Markings (4) | Samples |
|----------------------|---------------|--------------|-----------------|------|-------------|-------------------------|------------------|----------------------|--------------|--------------------------|-------------------------|
| LM3671MF-1.8 | ACTIVE | SOT-23 | DBV | 5 | 1000 | TBD | Call TI | Call TI | -30 to 85 | SBSB | Samples |
| LM3671MF-1.8/NOPB | ACTIVE | SOT-23 | DBV | 5 | 1000 | Green (RoHS & no Sb/Br) | CU SN | Level-1-260C-UNLIM | -30 to 85 | SBSB | Samples |
| LM3671MF-1.875 | ACTIVE | SOT-23 | DBV | 5 | 1000 | TBD | Call TI | Call TI | -30 to 85 | SDVB | Samples |
| LM3671MF-1.875/NOPB | ACTIVE | SOT-23 | DBV | 5 | 1000 | Green (RoHS & no Sb/Br) | CU SN | Level-1-260C-UNLIM | -30 to 85 | SDVB | Samples |
| LM3671MF-2.5 | ACTIVE | SOT-23 | DBV | 5 | 1000 | TBD | Call TI | Call TI | -30 to 85 | SJRB | Samples |
| LM3671MF-2.5/NOPB | ACTIVE | SOT-23 | DBV | 5 | 1000 | Green (RoHS & no Sb/Br) | CU SN | Level-1-260C-UNLIM | -30 to 85 | SJRB | Samples |
| LM3671MF-2.8 | ACTIVE | SOT-23 | DBV | 5 | 1000 | TBD | Call TI | Call TI | -30 to 85 | SJSB | Samples |
| LM3671MF-2.8/NOPB | ACTIVE | SOT-23 | DBV | 5 | 1000 | Green (RoHS & no Sb/Br) | CU SN | Level-1-260C-UNLIM | -30 to 85 | SJSB | Samples |
| LM3671MF-3.3 | ACTIVE | SOT-23 | DBV | 5 | 1000 | TBD | Call TI | Call TI | -30 to 85 | SJEB | Samples |
| LM3671MF-3.3/NOPB | ACTIVE | SOT-23 | DBV | 5 | 1000 | Green (RoHS & no Sb/Br) | CU SN | Level-1-260C-UNLIM | -30 to 85 | SJEB | Samples |
| LM3671MF-ADJ | ACTIVE | SOT-23 | DBV | 5 | 1000 | TBD | Call TI | Call TI | -30 to 85 | SBTB | Samples |
| LM3671MF-ADJ/NOPB | ACTIVE | SOT-23 | DBV | 5 | 1000 | Green (RoHS & no Sb/Br) | CU SN | Level-1-260C-UNLIM | -30 to 85 | SBTB | Samples |
| LM3671MFX-1.2 | ACTIVE | SOT-23 | DBV | 5 | 3000 | TBD | Call TI | Call TI | -30 to 85 | SBPB | Samples |
| LM3671MFX-1.2/NOPB | ACTIVE | SOT-23 | DBV | 5 | 3000 | Green (RoHS & no Sb/Br) | CU SN | Level-1-260C-UNLIM | -30 to 85 | SBPB | Samples |
| LM3671MFX-1.25 | ACTIVE | SOT-23 | DBV | 5 | 3000 | TBD | Call TI | Call TI | -30 to 85 | SDRB | Samples |
| LM3671MFX-1.25/NOPB | ACTIVE | SOT-23 | DBV | 5 | 3000 | Green (RoHS & no Sb/Br) | CU SN | Level-1-260C-UNLIM | -30 to 85 | SDRB | Samples |
| LM3671MFX-1.375 | ACTIVE | SOT-23 | DBV | 5 | 3000 | TBD | Call TI | Call TI | -30 to 85 | SEDB | Samples |
| LM3671MFX-1.375/NOPB | ACTIVE | SOT-23 | DBV | 5 | 3000 | Green (RoHS & no Sb/Br) | CU SN | Level-1-260C-UNLIM | -30 to 85 | SEDB | Samples |
| LM3671MFX-1.5 | ACTIVE | SOT-23 | DBV | 5 | 3000 | TBD | Call TI | Call TI | -30 to 85 | SBRB | Samples |

| Orderable Device | Status (1) | Package Type | Package Drawing | Pins | Package Qty | Eco Plan (2) | Lead/Ball Finish | MSL Peak Temp (3) | Op Temp (°C) | Top-Side Markings (4) | Samples |
|----------------------|---------------|--------------|-----------------|------|-------------|-------------------------|------------------|----------------------|--------------|--------------------------|-------------------------|
| LM3671MFX-1.5/NOPB | ACTIVE | SOT-23 | DBV | 5 | 3000 | Green (RoHS & no Sb/Br) | CU SN | Level-1-260C-UNLIM | -30 to 85 | SBRB | Samples |
| LM3671MFX-1.6 | ACTIVE | SOT-23 | DBV | 5 | 3000 | TBD | Call TI | Call TI | -30 to 85 | SDUB | Samples |
| LM3671MFX-1.6/NOPB | ACTIVE | SOT-23 | DBV | 5 | 3000 | Green (RoHS & no Sb/Br) | CU SN | Level-1-260C-UNLIM | -30 to 85 | SDUB | Samples |
| LM3671MFX-1.8 | ACTIVE | SOT-23 | DBV | 5 | 3000 | TBD | Call TI | Call TI | -30 to 85 | SBSB | Samples |
| LM3671MFX-1.8/NOPB | ACTIVE | SOT-23 | DBV | 5 | 3000 | Green (RoHS & no Sb/Br) | CU SN | Level-1-260C-UNLIM | -30 to 85 | SBSB | Samples |
| LM3671MFX-1.875 | ACTIVE | SOT-23 | DBV | 5 | 3000 | TBD | Call TI | Call TI | -30 to 85 | SDVB | Samples |
| LM3671MFX-1.875/NOPB | ACTIVE | SOT-23 | DBV | 5 | 3000 | Green (RoHS & no Sb/Br) | CU SN | Level-1-260C-UNLIM | -30 to 85 | SDVB | Samples |
| LM3671MFX-2.5 | ACTIVE | SOT-23 | DBV | 5 | 3000 | TBD | Call TI | Call TI | -30 to 85 | SJRB | Samples |
| LM3671MFX-2.5/NOPB | ACTIVE | SOT-23 | DBV | 5 | 3000 | Green (RoHS & no Sb/Br) | CU SN | Level-1-260C-UNLIM | -30 to 85 | SJRB | Samples |
| LM3671MFX-2.8 | ACTIVE | SOT-23 | DBV | 5 | 3000 | TBD | Call TI | Call TI | -30 to 85 | SJSB | Samples |
| LM3671MFX-2.8/NOPB | ACTIVE | SOT-23 | DBV | 5 | 3000 | Green (RoHS & no Sb/Br) | CU SN | Level-1-260C-UNLIM | -30 to 85 | SJSB | Samples |
| LM3671MFX-3.3 | ACTIVE | SOT-23 | DBV | 5 | 3000 | TBD | Call TI | Call TI | -30 to 85 | SJEB | Samples |
| LM3671MFX-3.3/NOPB | ACTIVE | SOT-23 | DBV | 5 | 3000 | Green (RoHS & no Sb/Br) | CU SN | Level-1-260C-UNLIM | -30 to 85 | SJEB | Samples |
| LM3671MFX-ADJ | ACTIVE | SOT-23 | DBV | 5 | 3000 | TBD | Call TI | Call TI | -30 to 85 | SBTB | Samples |
| LM3671MFX-ADJ/NOPB | ACTIVE | SOT-23 | DBV | 5 | 3000 | Green (RoHS & no Sb/Br) | CU SN | Level-1-260C-UNLIM | -30 to 85 | SBTB | Samples |
| LM3671QMF-1.2/NOPB | ACTIVE | SOT-23 | DBV | 5 | 1000 | Green (RoHS & no Sb/Br) | CU SN | Level-1-260C-UNLIM | -40 to 125 | SH4B | Samples |
| LM3671QMF-1.2/NOPB | ACTIVE | SOT-23 | DBV | 5 | 3000 | Green (RoHS & no Sb/Br) | CU SN | Level-1-260C-UNLIM | -40 to 125 | SH4B | Samples |
| LM3671TL-1.2/NOPB | ACTIVE | DSBGA | YZR | 5 | 250 | Green (RoHS & no Sb/Br) | SNAGCU | Level-1-260C-UNLIM | -30 to 85 | C | Samples |
| LM3671TL-1.5/NOPB | ACTIVE | DSBGA | YZR | 5 | 250 | Green (RoHS & no Sb/Br) | SNAGCU | Level-1-260C-UNLIM | -30 to 85 | D | Samples |

| Orderable Device | Status (1) | Package Type | Package Drawing | Pins | Package Qty | Eco Plan (2) | Lead/Ball Finish | MSL Peak Temp (3) | Op Temp (°C) | Top-Side Markings (4) | Samples |
|----------------------|---------------|--------------|-----------------|------|-------------|-------------------------|------------------|----------------------|--------------|--------------------------|-------------------------|
| LM3671TL-1.8/NOPB | ACTIVE | DSBGA | YZR | 5 | 250 | Green (RoHS & no Sb/Br) | SNAGCU | Level-1-260C-UNLIM | -30 to 85 | B | Samples |
| LM3671TL-1.875/NOPB | ACTIVE | DSBGA | YZR | 5 | 250 | Green (RoHS & no Sb/Br) | SNAGCU | Level-1-260C-UNLIM | -30 to 85 | S | Samples |
| LM3671TL-2.5/NOPB | ACTIVE | DSBGA | YZR | 5 | 250 | Green (RoHS & no Sb/Br) | SNAGCU | Level-1-260C-UNLIM | -30 to 85 | L | Samples |
| LM3671TL-2.8/NOPB | ACTIVE | DSBGA | YZR | 5 | 250 | Green (RoHS & no Sb/Br) | SNAGCU | Level-1-260C-UNLIM | -30 to 85 | K | Samples |
| LM3671TL-3.3/NOPB | ACTIVE | DSBGA | YZR | 5 | 250 | Green (RoHS & no Sb/Br) | SNAGCU | Level-1-260C-UNLIM | -30 to 85 | J | Samples |
| LM3671TL-ADJ/NOPB | ACTIVE | DSBGA | YZR | 5 | 250 | Green (RoHS & no Sb/Br) | SNAGCU | Level-1-260C-UNLIM | -30 to 85 | E | Samples |
| LM3671TLX-1.2/NOPB | ACTIVE | DSBGA | YZR | 5 | 3000 | Green (RoHS & no Sb/Br) | SNAGCU | Level-1-260C-UNLIM | -30 to 85 | C | Samples |
| LM3671TLX-1.5/NOPB | ACTIVE | DSBGA | YZR | 5 | 3000 | Green (RoHS & no Sb/Br) | SNAGCU | Level-1-260C-UNLIM | -30 to 85 | D | Samples |
| LM3671TLX-1.8/NOPB | ACTIVE | DSBGA | YZR | 5 | 3000 | Green (RoHS & no Sb/Br) | SNAGCU | Level-1-260C-UNLIM | -30 to 85 | B | Samples |
| LM3671TLX-1.875/NOPB | ACTIVE | DSBGA | YZR | 5 | 3000 | Green (RoHS & no Sb/Br) | SNAGCU | Level-1-260C-UNLIM | -30 to 85 | S | Samples |
| LM3671TLX-2.5/NOPB | ACTIVE | DSBGA | YZR | 5 | 3000 | Green (RoHS & no Sb/Br) | SNAGCU | Level-1-260C-UNLIM | -30 to 85 | L | Samples |
| LM3671TLX-2.8/NOPB | ACTIVE | DSBGA | YZR | 5 | 3000 | Green (RoHS & no Sb/Br) | SNAGCU | Level-1-260C-UNLIM | -30 to 85 | K | Samples |
| LM3671TLX-3.3/NOPB | ACTIVE | DSBGA | YZR | 5 | 3000 | Green (RoHS & no Sb/Br) | SNAGCU | Level-1-260C-UNLIM | -30 to 85 | J | Samples |
| LM3671TLX-ADJ/NOPB | ACTIVE | DSBGA | YZR | 5 | 3000 | Green (RoHS & no Sb/Br) | SNAGCU | Level-1-260C-UNLIM | -30 to 85 | E | Samples |

(1) The marketing status values are defined as follows:

ACTIVE: Product device recommended for new designs.

LIFEBUY: TI has announced that the device will be discontinued, and a lifetime-buy period is in effect.

NRND: Not recommended for new designs. Device is in production to support existing customers, but TI does not recommend using this part in a new design.

PREVIEW: Device has been announced but is not in production. Samples may or may not be available.

OBSOLETE: TI has discontinued the production of the device.

(2) Eco Plan - The planned eco-friendly classification: Pb-Free (RoHS), Pb-Free (RoHS Exempt), or Green (RoHS & no Sb/Br) - please check <http://www.ti.com/productcontent> for the latest availability information and additional product content details.

TBD: The Pb-Free/Green conversion plan has not been defined.

Pb-Free (RoHS): TI's terms "Lead-Free" or "Pb-Free" mean semiconductor products that are compatible with the current RoHS requirements for all 6 substances, including the requirement that lead not exceed 0.1% by weight in homogeneous materials. Where designed to be soldered at high temperatures, TI Pb-Free products are suitable for use in specified lead-free processes.

Pb-Free (RoHS Exempt): This component has a RoHS exemption for either 1) lead-based flip-chip solder bumps used between the die and package, or 2) lead-based die adhesive used between the die and leadframe. The component is otherwise considered Pb-Free (RoHS compatible) as defined above.

Green (RoHS & no Sb/Br): TI defines "Green" to mean Pb-Free (RoHS compatible), and free of Bromine (Br) and Antimony (Sb) based flame retardants (Br or Sb do not exceed 0.1% by weight in homogeneous material)

(3) MSL, Peak Temp. -- The Moisture Sensitivity Level rating according to the JEDEC industry standard classifications, and peak solder temperature.

(4) Multiple Top-Side Markings will be inside parentheses. Only one Top-Side Marking contained in parentheses and separated by a "~" will appear on a device. If a line is indented then it is a continuation of the previous line and the two combined represent the entire Top-Side Marking for that device.

Important Information and Disclaimer: The information provided on this page represents TI's knowledge and belief as of the date that it is provided. TI bases its knowledge and belief on information provided by third parties, and makes no representation or warranty as to the accuracy of such information. Efforts are underway to better integrate information from third parties. TI has taken and continues to take reasonable steps to provide representative and accurate information but may not have conducted destructive testing or chemical analysis on incoming materials and chemicals. TI and TI suppliers consider certain information to be proprietary, and thus CAS numbers and other limited information may not be available for release.

In no event shall TI's liability arising out of such information exceed the total purchase price of the TI part(s) at issue in this document sold by TI to Customer on an annual basis.

OTHER QUALIFIED VERSIONS OF LM3671, LM3671-Q1 :

● Catalog: [LM3671](#)

● Automotive: [LM3671-Q1](#)

NOTE: Qualified Version Definitions:

- Catalog - TI's standard catalog product
- Automotive - Q100 devices qualified for high-reliability automotive applications targeting zero defects

TAPE AND REEL INFORMATION



QUADRANT ASSIGNMENTS FOR PIN 1 ORIENTATION IN TAPE



*All dimensions are nominal

| Device | Package Type | Package Drawing | Pins | SPQ | Reel Diameter (mm) | Reel Width W1 (mm) | A0 (mm) | B0 (mm) | K0 (mm) | P1 (mm) | W (mm) | Pin1 Quadrant |
|---------------------|--------------|-----------------|------|------|--------------------|--------------------|---------|---------|---------|---------|--------|---------------|
| LM3671LC-1.2/NOPB | USON | NKH | 6 | 1000 | 178.0 | 12.4 | 2.2 | 2.2 | 1.0 | 8.0 | 12.0 | Q1 |
| LM3671LC-1.3/NOPB | USON | NKH | 6 | 1000 | 178.0 | 12.4 | 2.2 | 2.2 | 1.0 | 8.0 | 12.0 | Q1 |
| LM3671LC-1.6/NOPB | USON | NKH | 6 | 1000 | 178.0 | 12.4 | 2.2 | 2.2 | 1.0 | 8.0 | 12.0 | Q1 |
| LM3671LC-1.8/NOPB | USON | NKH | 6 | 1000 | 178.0 | 12.4 | 2.2 | 2.2 | 1.0 | 8.0 | 12.0 | Q1 |
| LM3671LCX-1.2/NOPB | USON | NKH | 6 | 4500 | 330.0 | 12.4 | 2.2 | 2.2 | 1.0 | 8.0 | 12.0 | Q1 |
| LM3671LCX-1.3/NOPB | USON | NKH | 6 | 4500 | 330.0 | 12.4 | 2.2 | 2.2 | 1.0 | 8.0 | 12.0 | Q1 |
| LM3671LCX-1.6/NOPB | USON | NKH | 6 | 4500 | 330.0 | 12.4 | 2.2 | 2.2 | 1.0 | 8.0 | 12.0 | Q1 |
| LM3671LCX-1.8/NOPB | USON | NKH | 6 | 4500 | 330.0 | 12.4 | 2.2 | 2.2 | 1.0 | 8.0 | 12.0 | Q1 |
| LM3671MF-1.2 | SOT-23 | DBV | 5 | 1000 | 178.0 | 8.4 | 3.2 | 3.2 | 1.4 | 4.0 | 8.0 | Q3 |
| LM3671MF-1.2/NOPB | SOT-23 | DBV | 5 | 1000 | 178.0 | 8.4 | 3.2 | 3.2 | 1.4 | 4.0 | 8.0 | Q3 |
| LM3671MF-1.25 | SOT-23 | DBV | 5 | 1000 | 178.0 | 8.4 | 3.2 | 3.2 | 1.4 | 4.0 | 8.0 | Q3 |
| LM3671MF-1.25/NOPB | SOT-23 | DBV | 5 | 1000 | 178.0 | 8.4 | 3.2 | 3.2 | 1.4 | 4.0 | 8.0 | Q3 |
| LM3671MF-1.375 | SOT-23 | DBV | 5 | 1000 | 178.0 | 8.4 | 3.2 | 3.2 | 1.4 | 4.0 | 8.0 | Q3 |
| LM3671MF-1.375/NOPB | SOT-23 | DBV | 5 | 1000 | 178.0 | 8.4 | 3.2 | 3.2 | 1.4 | 4.0 | 8.0 | Q3 |
| LM3671MF-1.5 | SOT-23 | DBV | 5 | 1000 | 178.0 | 8.4 | 3.2 | 3.2 | 1.4 | 4.0 | 8.0 | Q3 |
| LM3671MF-1.5/NOPB | SOT-23 | DBV | 5 | 1000 | 178.0 | 8.4 | 3.2 | 3.2 | 1.4 | 4.0 | 8.0 | Q3 |
| LM3671MF-1.6 | SOT-23 | DBV | 5 | 1000 | 178.0 | 8.4 | 3.2 | 3.2 | 1.4 | 4.0 | 8.0 | Q3 |
| LM3671MF-1.6/NOPB | SOT-23 | DBV | 5 | 1000 | 178.0 | 8.4 | 3.2 | 3.2 | 1.4 | 4.0 | 8.0 | Q3 |

| Device | Package Type | Package Drawing | Pins | SPQ | Reel Diameter (mm) | Reel Width W1 (mm) | A0 (mm) | B0 (mm) | K0 (mm) | P1 (mm) | W (mm) | Pin1 Quadrant |
|----------------------|--------------|-----------------|------|------|--------------------|--------------------|---------|---------|---------|---------|--------|---------------|
| LM3671MF-1.8 | SOT-23 | DBV | 5 | 1000 | 178.0 | 8.4 | 3.2 | 3.2 | 1.4 | 4.0 | 8.0 | Q3 |
| LM3671MF-1.8/NOPB | SOT-23 | DBV | 5 | 1000 | 178.0 | 8.4 | 3.2 | 3.2 | 1.4 | 4.0 | 8.0 | Q3 |
| LM3671MF-1.875 | SOT-23 | DBV | 5 | 1000 | 178.0 | 8.4 | 3.2 | 3.2 | 1.4 | 4.0 | 8.0 | Q3 |
| LM3671MF-1.875/NOPB | SOT-23 | DBV | 5 | 1000 | 178.0 | 8.4 | 3.2 | 3.2 | 1.4 | 4.0 | 8.0 | Q3 |
| LM3671MF-2.5 | SOT-23 | DBV | 5 | 1000 | 178.0 | 8.4 | 3.2 | 3.2 | 1.4 | 4.0 | 8.0 | Q3 |
| LM3671MF-2.5/NOPB | SOT-23 | DBV | 5 | 1000 | 178.0 | 8.4 | 3.2 | 3.2 | 1.4 | 4.0 | 8.0 | Q3 |
| LM3671MF-2.8 | SOT-23 | DBV | 5 | 1000 | 178.0 | 8.4 | 3.2 | 3.2 | 1.4 | 4.0 | 8.0 | Q3 |
| LM3671MF-2.8/NOPB | SOT-23 | DBV | 5 | 1000 | 178.0 | 8.4 | 3.2 | 3.2 | 1.4 | 4.0 | 8.0 | Q3 |
| LM3671MF-3.3 | SOT-23 | DBV | 5 | 1000 | 178.0 | 8.4 | 3.2 | 3.2 | 1.4 | 4.0 | 8.0 | Q3 |
| LM3671MF-3.3/NOPB | SOT-23 | DBV | 5 | 1000 | 178.0 | 8.4 | 3.2 | 3.2 | 1.4 | 4.0 | 8.0 | Q3 |
| LM3671MF-ADJ | SOT-23 | DBV | 5 | 1000 | 178.0 | 8.4 | 3.2 | 3.2 | 1.4 | 4.0 | 8.0 | Q3 |
| LM3671MF-ADJ/NOPB | SOT-23 | DBV | 5 | 1000 | 178.0 | 8.4 | 3.2 | 3.2 | 1.4 | 4.0 | 8.0 | Q3 |
| LM3671MFX-1.2 | SOT-23 | DBV | 5 | 3000 | 178.0 | 8.4 | 3.2 | 3.2 | 1.4 | 4.0 | 8.0 | Q3 |
| LM3671MFX-1.2/NOPB | SOT-23 | DBV | 5 | 3000 | 178.0 | 8.4 | 3.2 | 3.2 | 1.4 | 4.0 | 8.0 | Q3 |
| LM3671MFX-1.25 | SOT-23 | DBV | 5 | 3000 | 178.0 | 8.4 | 3.2 | 3.2 | 1.4 | 4.0 | 8.0 | Q3 |
| LM3671MFX-1.25/NOPB | SOT-23 | DBV | 5 | 3000 | 178.0 | 8.4 | 3.2 | 3.2 | 1.4 | 4.0 | 8.0 | Q3 |
| LM3671MFX-1.375 | SOT-23 | DBV | 5 | 3000 | 178.0 | 8.4 | 3.2 | 3.2 | 1.4 | 4.0 | 8.0 | Q3 |
| LM3671MFX-1.375/NOPB | SOT-23 | DBV | 5 | 3000 | 178.0 | 8.4 | 3.2 | 3.2 | 1.4 | 4.0 | 8.0 | Q3 |
| LM3671MFX-1.5 | SOT-23 | DBV | 5 | 3000 | 178.0 | 8.4 | 3.2 | 3.2 | 1.4 | 4.0 | 8.0 | Q3 |
| LM3671MFX-1.5/NOPB | SOT-23 | DBV | 5 | 3000 | 178.0 | 8.4 | 3.2 | 3.2 | 1.4 | 4.0 | 8.0 | Q3 |
| LM3671MFX-1.6 | SOT-23 | DBV | 5 | 3000 | 178.0 | 8.4 | 3.2 | 3.2 | 1.4 | 4.0 | 8.0 | Q3 |
| LM3671MFX-1.6/NOPB | SOT-23 | DBV | 5 | 3000 | 178.0 | 8.4 | 3.2 | 3.2 | 1.4 | 4.0 | 8.0 | Q3 |
| LM3671MFX-1.8 | SOT-23 | DBV | 5 | 3000 | 178.0 | 8.4 | 3.2 | 3.2 | 1.4 | 4.0 | 8.0 | Q3 |
| LM3671MFX-1.8/NOPB | SOT-23 | DBV | 5 | 3000 | 178.0 | 8.4 | 3.2 | 3.2 | 1.4 | 4.0 | 8.0 | Q3 |
| LM3671MFX-1.875 | SOT-23 | DBV | 5 | 3000 | 178.0 | 8.4 | 3.2 | 3.2 | 1.4 | 4.0 | 8.0 | Q3 |
| LM3671MFX-1.875/NOPB | SOT-23 | DBV | 5 | 3000 | 178.0 | 8.4 | 3.2 | 3.2 | 1.4 | 4.0 | 8.0 | Q3 |
| LM3671MFX-2.5 | SOT-23 | DBV | 5 | 3000 | 178.0 | 8.4 | 3.2 | 3.2 | 1.4 | 4.0 | 8.0 | Q3 |
| LM3671MFX-2.5/NOPB | SOT-23 | DBV | 5 | 3000 | 178.0 | 8.4 | 3.2 | 3.2 | 1.4 | 4.0 | 8.0 | Q3 |
| LM3671MFX-2.8 | SOT-23 | DBV | 5 | 3000 | 178.0 | 8.4 | 3.2 | 3.2 | 1.4 | 4.0 | 8.0 | Q3 |
| LM3671MFX-2.8/NOPB | SOT-23 | DBV | 5 | 3000 | 178.0 | 8.4 | 3.2 | 3.2 | 1.4 | 4.0 | 8.0 | Q3 |
| LM3671MFX-3.3 | SOT-23 | DBV | 5 | 3000 | 178.0 | 8.4 | 3.2 | 3.2 | 1.4 | 4.0 | 8.0 | Q3 |
| LM3671MFX-3.3/NOPB | SOT-23 | DBV | 5 | 3000 | 178.0 | 8.4 | 3.2 | 3.2 | 1.4 | 4.0 | 8.0 | Q3 |
| LM3671MFX-ADJ | SOT-23 | DBV | 5 | 3000 | 178.0 | 8.4 | 3.2 | 3.2 | 1.4 | 4.0 | 8.0 | Q3 |
| LM3671MFX-ADJ/NOPB | SOT-23 | DBV | 5 | 3000 | 178.0 | 8.4 | 3.2 | 3.2 | 1.4 | 4.0 | 8.0 | Q3 |
| LM3671QMF-1.2/NOPB | SOT-23 | DBV | 5 | 1000 | 178.0 | 8.4 | 3.2 | 3.2 | 1.4 | 4.0 | 8.0 | Q3 |
| LM3671QMFX-1.2/NOPB | SOT-23 | DBV | 5 | 3000 | 178.0 | 8.4 | 3.2 | 3.2 | 1.4 | 4.0 | 8.0 | Q3 |
| LM3671TL-1.2/NOPB | DSBGA | YZR | 5 | 250 | 178.0 | 8.4 | 1.14 | 1.47 | 0.76 | 4.0 | 8.0 | Q1 |
| LM3671TL-1.5/NOPB | DSBGA | YZR | 5 | 250 | 178.0 | 8.4 | 1.14 | 1.47 | 0.76 | 4.0 | 8.0 | Q1 |
| LM3671TL-1.8/NOPB | DSBGA | YZR | 5 | 250 | 178.0 | 8.4 | 1.14 | 1.47 | 0.76 | 4.0 | 8.0 | Q1 |
| LM3671TL-1.875/NOPB | DSBGA | YZR | 5 | 250 | 178.0 | 8.4 | 1.14 | 1.47 | 0.76 | 4.0 | 8.0 | Q1 |
| LM3671TL-2.5/NOPB | DSBGA | YZR | 5 | 250 | 178.0 | 8.4 | 1.14 | 1.47 | 0.76 | 4.0 | 8.0 | Q1 |
| LM3671TL-2.8/NOPB | DSBGA | YZR | 5 | 250 | 178.0 | 8.4 | 1.14 | 1.47 | 0.76 | 4.0 | 8.0 | Q1 |
| LM3671TL-3.3/NOPB | DSBGA | YZR | 5 | 250 | 178.0 | 8.4 | 1.14 | 1.47 | 0.76 | 4.0 | 8.0 | Q1 |

| Device | Package Type | Package Drawing | Pins | SPQ | Reel Diameter (mm) | Reel Width W1 (mm) | A0 (mm) | B0 (mm) | K0 (mm) | P1 (mm) | W (mm) | Pin1 Quadrant |
|----------------------|--------------|-----------------|------|------|--------------------|--------------------|---------|---------|---------|---------|--------|---------------|
| LM3671TL-ADJ/NOPB | DSBGA | YZR | 5 | 250 | 178.0 | 8.4 | 1.14 | 1.47 | 0.76 | 4.0 | 8.0 | Q1 |
| LM3671TLX-1.2/NOPB | DSBGA | YZR | 5 | 3000 | 178.0 | 8.4 | 1.14 | 1.47 | 0.76 | 4.0 | 8.0 | Q1 |
| LM3671TLX-1.5/NOPB | DSBGA | YZR | 5 | 3000 | 178.0 | 8.4 | 1.14 | 1.47 | 0.76 | 4.0 | 8.0 | Q1 |
| LM3671TLX-1.8/NOPB | DSBGA | YZR | 5 | 3000 | 178.0 | 8.4 | 1.14 | 1.47 | 0.76 | 4.0 | 8.0 | Q1 |
| LM3671TLX-1.875/NOPB | DSBGA | YZR | 5 | 3000 | 178.0 | 8.4 | 1.14 | 1.47 | 0.76 | 4.0 | 8.0 | Q1 |
| LM3671TLX-2.5/NOPB | DSBGA | YZR | 5 | 3000 | 178.0 | 8.4 | 1.14 | 1.47 | 0.76 | 4.0 | 8.0 | Q1 |
| LM3671TLX-2.8/NOPB | DSBGA | YZR | 5 | 3000 | 178.0 | 8.4 | 1.14 | 1.47 | 0.76 | 4.0 | 8.0 | Q1 |
| LM3671TLX-3.3/NOPB | DSBGA | YZR | 5 | 3000 | 178.0 | 8.4 | 1.14 | 1.47 | 0.76 | 4.0 | 8.0 | Q1 |
| LM3671TLX-ADJ/NOPB | DSBGA | YZR | 5 | 3000 | 178.0 | 8.4 | 1.14 | 1.47 | 0.76 | 4.0 | 8.0 | Q1 |

TAPE AND REEL BOX DIMENSIONS

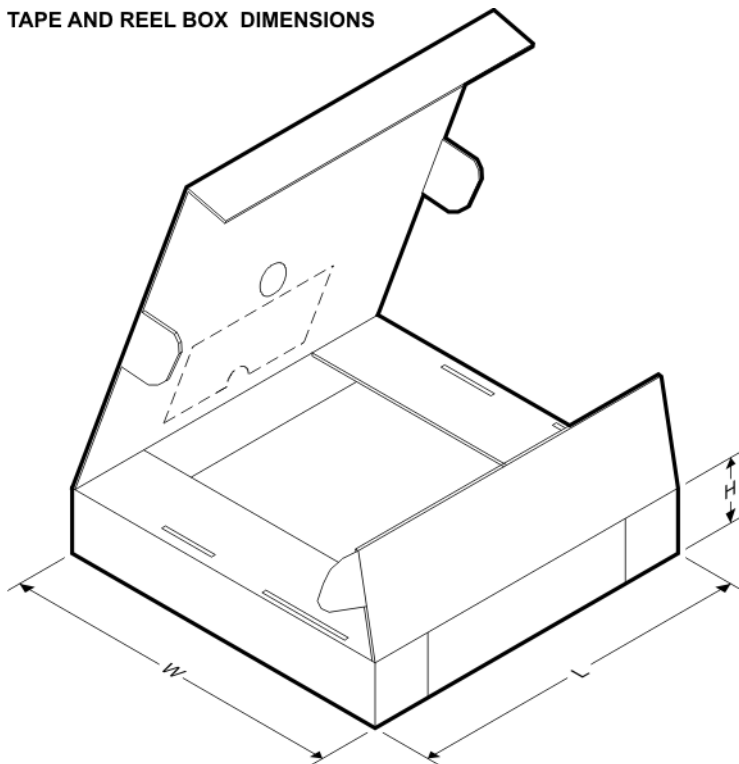

*All dimensions are nominal

| Device | Package Type | Package Drawing | Pins | SPQ | Length (mm) | Width (mm) | Height (mm) |
|--------------------|--------------|-----------------|------|------|-------------|------------|-------------|
| LM3671LC-1.2/NOPB | USON | NKH | 6 | 1000 | 203.0 | 190.0 | 41.0 |
| LM3671LC-1.3/NOPB | USON | NKH | 6 | 1000 | 210.0 | 185.0 | 35.0 |
| LM3671LC-1.6/NOPB | USON | NKH | 6 | 1000 | 210.0 | 185.0 | 35.0 |
| LM3671LC-1.8/NOPB | USON | NKH | 6 | 1000 | 210.0 | 185.0 | 35.0 |
| LM3671LCX-1.2/NOPB | USON | NKH | 6 | 4500 | 367.0 | 367.0 | 35.0 |
| LM3671LCX-1.3/NOPB | USON | NKH | 6 | 4500 | 367.0 | 367.0 | 35.0 |
| LM3671LCX-1.6/NOPB | USON | NKH | 6 | 4500 | 367.0 | 367.0 | 35.0 |
| LM3671LCX-1.8/NOPB | USON | NKH | 6 | 4500 | 367.0 | 367.0 | 35.0 |

| Device | Package Type | Package Drawing | Pins | SPQ | Length (mm) | Width (mm) | Height (mm) |
|----------------------|--------------|-----------------|------|------|-------------|------------|-------------|
| LM3671MF-1.2 | SOT-23 | DBV | 5 | 1000 | 210.0 | 185.0 | 35.0 |
| LM3671MF-1.2/NOPB | SOT-23 | DBV | 5 | 1000 | 210.0 | 185.0 | 35.0 |
| LM3671MF-1.25 | SOT-23 | DBV | 5 | 1000 | 210.0 | 185.0 | 35.0 |
| LM3671MF-1.25/NOPB | SOT-23 | DBV | 5 | 1000 | 210.0 | 185.0 | 35.0 |
| LM3671MF-1.375 | SOT-23 | DBV | 5 | 1000 | 210.0 | 185.0 | 35.0 |
| LM3671MF-1.375/NOPB | SOT-23 | DBV | 5 | 1000 | 210.0 | 185.0 | 35.0 |
| LM3671MF-1.5 | SOT-23 | DBV | 5 | 1000 | 210.0 | 185.0 | 35.0 |
| LM3671MF-1.5/NOPB | SOT-23 | DBV | 5 | 1000 | 210.0 | 185.0 | 35.0 |
| LM3671MF-1.6 | SOT-23 | DBV | 5 | 1000 | 210.0 | 185.0 | 35.0 |
| LM3671MF-1.6/NOPB | SOT-23 | DBV | 5 | 1000 | 210.0 | 185.0 | 35.0 |
| LM3671MF-1.8 | SOT-23 | DBV | 5 | 1000 | 210.0 | 185.0 | 35.0 |
| LM3671MF-1.8/NOPB | SOT-23 | DBV | 5 | 1000 | 210.0 | 185.0 | 35.0 |
| LM3671MF-1.875 | SOT-23 | DBV | 5 | 1000 | 210.0 | 185.0 | 35.0 |
| LM3671MF-1.875/NOPB | SOT-23 | DBV | 5 | 1000 | 210.0 | 185.0 | 35.0 |
| LM3671MF-2.5 | SOT-23 | DBV | 5 | 1000 | 210.0 | 185.0 | 35.0 |
| LM3671MF-2.5/NOPB | SOT-23 | DBV | 5 | 1000 | 210.0 | 185.0 | 35.0 |
| LM3671MF-2.8 | SOT-23 | DBV | 5 | 1000 | 210.0 | 185.0 | 35.0 |
| LM3671MF-2.8/NOPB | SOT-23 | DBV | 5 | 1000 | 210.0 | 185.0 | 35.0 |
| LM3671MF-3.3 | SOT-23 | DBV | 5 | 1000 | 210.0 | 185.0 | 35.0 |
| LM3671MF-3.3/NOPB | SOT-23 | DBV | 5 | 1000 | 210.0 | 185.0 | 35.0 |
| LM3671MF-ADJ | SOT-23 | DBV | 5 | 1000 | 210.0 | 185.0 | 35.0 |
| LM3671MF-ADJ/NOPB | SOT-23 | DBV | 5 | 1000 | 210.0 | 185.0 | 35.0 |
| LM3671MFX-1.2 | SOT-23 | DBV | 5 | 3000 | 210.0 | 185.0 | 35.0 |
| LM3671MFX-1.2/NOPB | SOT-23 | DBV | 5 | 3000 | 210.0 | 185.0 | 35.0 |
| LM3671MFX-1.25 | SOT-23 | DBV | 5 | 3000 | 210.0 | 185.0 | 35.0 |
| LM3671MFX-1.25/NOPB | SOT-23 | DBV | 5 | 3000 | 210.0 | 185.0 | 35.0 |
| LM3671MFX-1.375 | SOT-23 | DBV | 5 | 3000 | 210.0 | 185.0 | 35.0 |
| LM3671MFX-1.375/NOPB | SOT-23 | DBV | 5 | 3000 | 210.0 | 185.0 | 35.0 |
| LM3671MFX-1.5 | SOT-23 | DBV | 5 | 3000 | 210.0 | 185.0 | 35.0 |
| LM3671MFX-1.5/NOPB | SOT-23 | DBV | 5 | 3000 | 210.0 | 185.0 | 35.0 |
| LM3671MFX-1.6 | SOT-23 | DBV | 5 | 3000 | 210.0 | 185.0 | 35.0 |
| LM3671MFX-1.6/NOPB | SOT-23 | DBV | 5 | 3000 | 210.0 | 185.0 | 35.0 |
| LM3671MFX-1.8 | SOT-23 | DBV | 5 | 3000 | 210.0 | 185.0 | 35.0 |
| LM3671MFX-1.8/NOPB | SOT-23 | DBV | 5 | 3000 | 210.0 | 185.0 | 35.0 |
| LM3671MFX-1.875 | SOT-23 | DBV | 5 | 3000 | 210.0 | 185.0 | 35.0 |
| LM3671MFX-1.875/NOPB | SOT-23 | DBV | 5 | 3000 | 210.0 | 185.0 | 35.0 |
| LM3671MFX-2.5 | SOT-23 | DBV | 5 | 3000 | 210.0 | 185.0 | 35.0 |
| LM3671MFX-2.5/NOPB | SOT-23 | DBV | 5 | 3000 | 210.0 | 185.0 | 35.0 |
| LM3671MFX-2.8 | SOT-23 | DBV | 5 | 3000 | 210.0 | 185.0 | 35.0 |
| LM3671MFX-2.8/NOPB | SOT-23 | DBV | 5 | 3000 | 210.0 | 185.0 | 35.0 |
| LM3671MFX-3.3 | SOT-23 | DBV | 5 | 3000 | 210.0 | 185.0 | 35.0 |
| LM3671MFX-3.3/NOPB | SOT-23 | DBV | 5 | 3000 | 210.0 | 185.0 | 35.0 |
| LM3671MFX-ADJ | SOT-23 | DBV | 5 | 3000 | 210.0 | 185.0 | 35.0 |
| LM3671MFX-ADJ/NOPB | SOT-23 | DBV | 5 | 3000 | 210.0 | 185.0 | 35.0 |

| Device | Package Type | Package Drawing | Pins | SPQ | Length (mm) | Width (mm) | Height (mm) |
|----------------------|--------------|-----------------|------|------|-------------|------------|-------------|
| LM3671QMF-1.2/NOPB | SOT-23 | DBV | 5 | 1000 | 210.0 | 185.0 | 35.0 |
| LM3671QMF-1.2/NOPB | SOT-23 | DBV | 5 | 3000 | 210.0 | 185.0 | 35.0 |
| LM3671TL-1.2/NOPB | DSBGA | YZR | 5 | 250 | 210.0 | 185.0 | 35.0 |
| LM3671TL-1.5/NOPB | DSBGA | YZR | 5 | 250 | 210.0 | 185.0 | 35.0 |
| LM3671TL-1.8/NOPB | DSBGA | YZR | 5 | 250 | 210.0 | 185.0 | 35.0 |
| LM3671TL-1.875/NOPB | DSBGA | YZR | 5 | 250 | 210.0 | 185.0 | 35.0 |
| LM3671TL-2.5/NOPB | DSBGA | YZR | 5 | 250 | 210.0 | 185.0 | 35.0 |
| LM3671TL-2.8/NOPB | DSBGA | YZR | 5 | 250 | 210.0 | 185.0 | 35.0 |
| LM3671TL-3.3/NOPB | DSBGA | YZR | 5 | 250 | 210.0 | 185.0 | 35.0 |
| LM3671TL-ADJ/NOPB | DSBGA | YZR | 5 | 250 | 210.0 | 185.0 | 35.0 |
| LM3671TLX-1.2/NOPB | DSBGA | YZR | 5 | 3000 | 210.0 | 185.0 | 35.0 |
| LM3671TLX-1.5/NOPB | DSBGA | YZR | 5 | 3000 | 210.0 | 185.0 | 35.0 |
| LM3671TLX-1.8/NOPB | DSBGA | YZR | 5 | 3000 | 210.0 | 185.0 | 35.0 |
| LM3671TLX-1.875/NOPB | DSBGA | YZR | 5 | 3000 | 210.0 | 185.0 | 35.0 |
| LM3671TLX-2.5/NOPB | DSBGA | YZR | 5 | 3000 | 210.0 | 185.0 | 35.0 |
| LM3671TLX-2.8/NOPB | DSBGA | YZR | 5 | 3000 | 210.0 | 185.0 | 35.0 |
| LM3671TLX-3.3/NOPB | DSBGA | YZR | 5 | 3000 | 210.0 | 185.0 | 35.0 |
| LM3671TLX-ADJ/NOPB | DSBGA | YZR | 5 | 3000 | 210.0 | 185.0 | 35.0 |

DBV (R-PDSO-G5)

PLASTIC SMALL-OUTLINE PACKAGE



- NOTES:
- A. All linear dimensions are in millimeters.
 - B. This drawing is subject to change without notice.
 - C. Body dimensions do not include mold flash or protrusion. Mold flash and protrusion shall not exceed 0.15 per side.
 - D. Falls within JEDEC MO-178 Variation AA.

DBV (R-PDSO-G5)

PLASTIC SMALL OUTLINE



- NOTES:
- A. All linear dimensions are in millimeters.
 - B. This drawing is subject to change without notice.
 - C. Customers should place a note on the circuit board fabrication drawing not to alter the center solder mask defined pad.
 - D. Publication IPC-7351 is recommended for alternate designs.
 - E. Laser cutting apertures with trapezoidal walls and also rounding corners will offer better paste release. Customers should contact their board assembly site for stencil design recommendations. Example stencil design based on a 50% volumetric metal load solder paste. Refer to IPC-7525 for other stencil recommendations.

NKH0006B

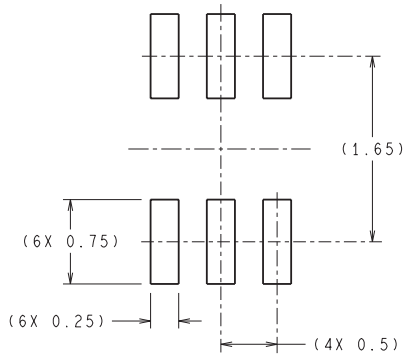

RECOMMENDED LAND PATTERN

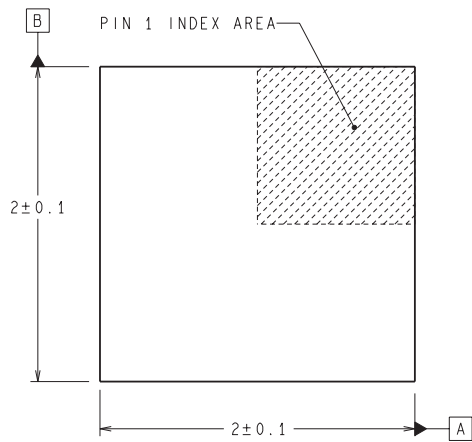

DIMENSIONS ARE IN MILLIMETERS
DIMENSION IN () FOR REFERENCE ONLY

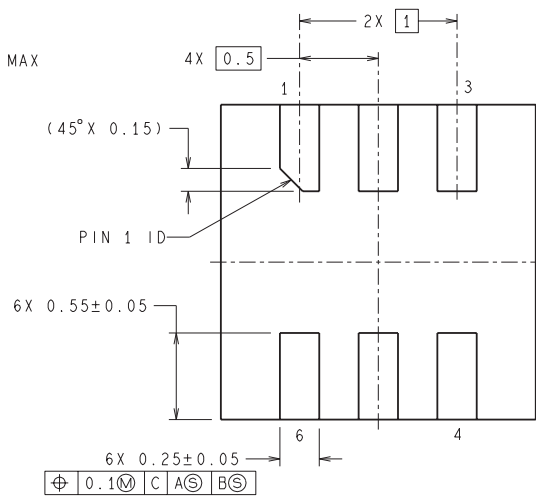
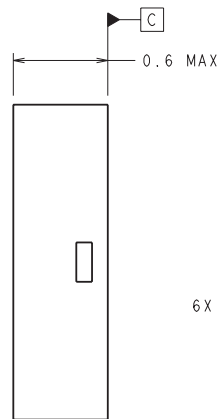
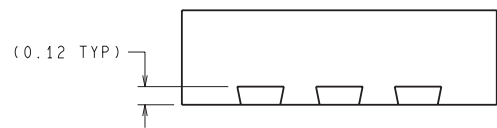

Φ 0.1 (M) C A ⊙ B ⊙

LCA06B (Rev A)

YZR0005

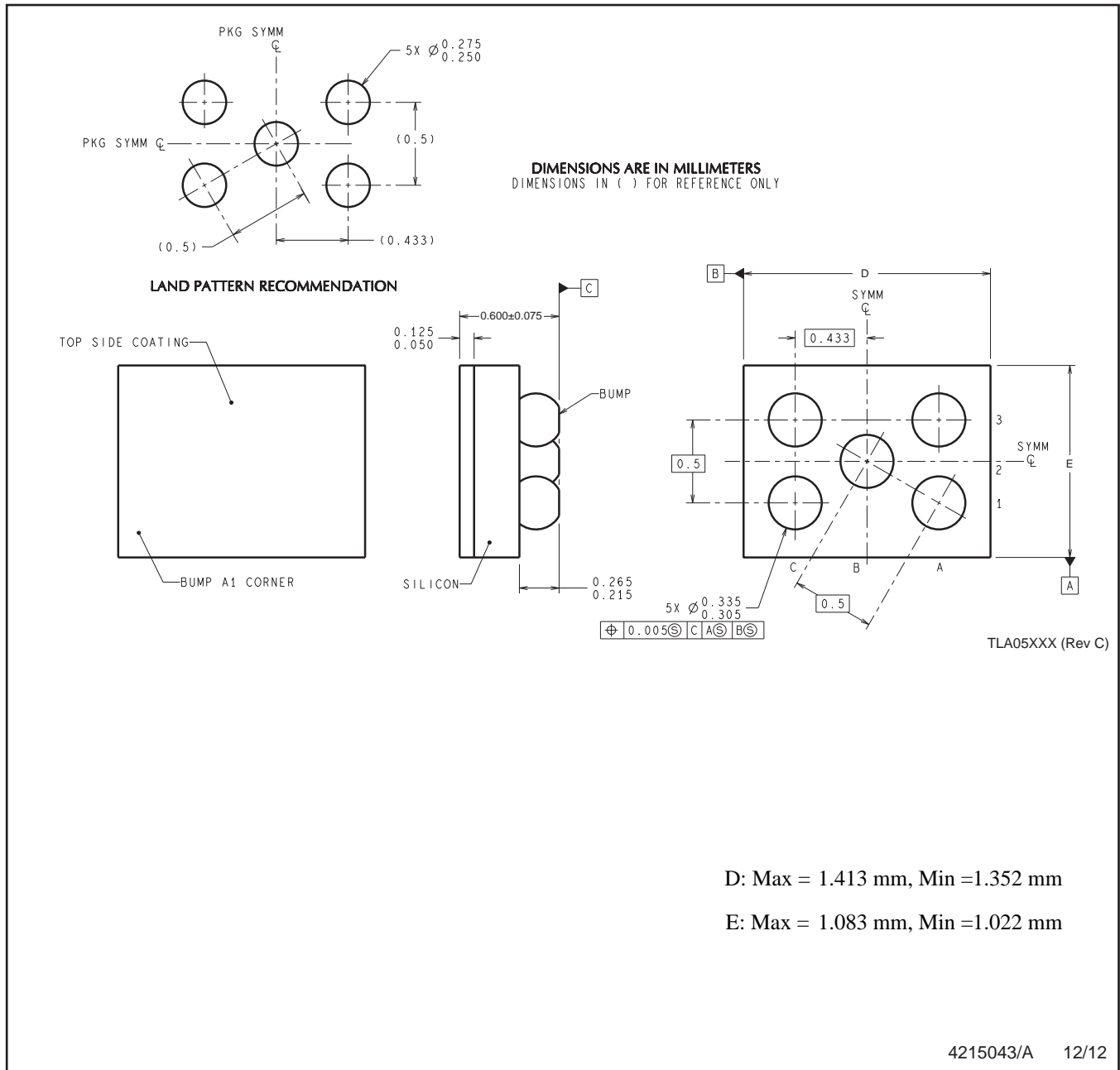

D: Max = 1.413 mm, Min =1.352 mm

E: Max = 1.083 mm, Min =1.022 mm

4215043/A 12/12

NOTES: A. All linear dimensions are in millimeters. Dimensioning and tolerancing per ASME Y14.5M-1994.
 B. This drawing is subject to change without notice.

IMPORTANT NOTICE

Texas Instruments Incorporated and its subsidiaries (TI) reserve the right to make corrections, enhancements, improvements and other changes to its semiconductor products and services per JESD46, latest issue, and to discontinue any product or service per JESD48, latest issue. Buyers should obtain the latest relevant information before placing orders and should verify that such information is current and complete. All semiconductor products (also referred to herein as "components") are sold subject to TI's terms and conditions of sale supplied at the time of order acknowledgment.

TI warrants performance of its components to the specifications applicable at the time of sale, in accordance with the warranty in TI's terms and conditions of sale of semiconductor products. Testing and other quality control techniques are used to the extent TI deems necessary to support this warranty. Except where mandated by applicable law, testing of all parameters of each component is not necessarily performed.

TI assumes no liability for applications assistance or the design of Buyers' products. Buyers are responsible for their products and applications using TI components. To minimize the risks associated with Buyers' products and applications, Buyers should provide adequate design and operating safeguards.

TI does not warrant or represent that any license, either express or implied, is granted under any patent right, copyright, mask work right, or other intellectual property right relating to any combination, machine, or process in which TI components or services are used. Information published by TI regarding third-party products or services does not constitute a license to use such products or services or a warranty or endorsement thereof. Use of such information may require a license from a third party under the patents or other intellectual property of the third party, or a license from TI under the patents or other intellectual property of TI.

Reproduction of significant portions of TI information in TI data books or data sheets is permissible only if reproduction is without alteration and is accompanied by all associated warranties, conditions, limitations, and notices. TI is not responsible or liable for such altered documentation. Information of third parties may be subject to additional restrictions.

Resale of TI components or services with statements different from or beyond the parameters stated by TI for that component or service voids all express and any implied warranties for the associated TI component or service and is an unfair and deceptive business practice. TI is not responsible or liable for any such statements.

Buyer acknowledges and agrees that it is solely responsible for compliance with all legal, regulatory and safety-related requirements concerning its products, and any use of TI components in its applications, notwithstanding any applications-related information or support that may be provided by TI. Buyer represents and agrees that it has all the necessary expertise to create and implement safeguards which anticipate dangerous consequences of failures, monitor failures and their consequences, lessen the likelihood of failures that might cause harm and take appropriate remedial actions. Buyer will fully indemnify TI and its representatives against any damages arising out of the use of any TI components in safety-critical applications.

In some cases, TI components may be promoted specifically to facilitate safety-related applications. With such components, TI's goal is to help enable customers to design and create their own end-product solutions that meet applicable functional safety standards and requirements. Nonetheless, such components are subject to these terms.

No TI components are authorized for use in FDA Class III (or similar life-critical medical equipment) unless authorized officers of the parties have executed a special agreement specifically governing such use.

Only those TI components which TI has specifically designated as military grade or "enhanced plastic" are designed and intended for use in military/aerospace applications or environments. Buyer acknowledges and agrees that any military or aerospace use of TI components which have **not** been so designated is solely at the Buyer's risk, and that Buyer is solely responsible for compliance with all legal and regulatory requirements in connection with such use.

TI has specifically designated certain components as meeting ISO/TS16949 requirements, mainly for automotive use. In any case of use of non-designated products, TI will not be responsible for any failure to meet ISO/TS16949.

Products

| | |
|------------------------------|--|
| Audio | www.ti.com/audio |
| Amplifiers | amplifier.ti.com |
| Data Converters | dataconverter.ti.com |
| DLP® Products | www.dlp.com |
| DSP | dsp.ti.com |
| Clocks and Timers | www.ti.com/clocks |
| Interface | interface.ti.com |
| Logic | logic.ti.com |
| Power Mgmt | power.ti.com |
| Microcontrollers | microcontroller.ti.com |
| RFID | www.ti-rfid.com |
| OMAP Applications Processors | www.ti.com/omap |
| Wireless Connectivity | www.ti.com/wirelessconnectivity |

Applications

| | |
|-------------------------------|--|
| Automotive and Transportation | www.ti.com/automotive |
| Communications and Telecom | www.ti.com/communications |
| Computers and Peripherals | www.ti.com/computers |
| Consumer Electronics | www.ti.com/consumer-apps |
| Energy and Lighting | www.ti.com/energy |
| Industrial | www.ti.com/industrial |
| Medical | www.ti.com/medical |
| Security | www.ti.com/security |
| Space, Avionics and Defense | www.ti.com/space-avionics-defense |
| Video and Imaging | www.ti.com/video |

TI E2E Community

e2e.ti.com