



Designed for snap-on-back panel rail mounting on either a 35mm x 7.5mm, or a 35mm x 15mm Symmetrical Din Rail, allowing rapid and simple mounting and removal of the breaker. It features recessed, wire-ready, touch-proof, shock-resistant terminals, suitable for automatic screwdriver assembly, as well as "Dead Front" construction characteristics.

Available with a Visi-Rocker two-color actuator, which can be specified to indicate either the ON or the TRIPPED/OFF mode, or solid color rocker or handle type actuators. All actuator types fit in the same industry standard panel cutouts.

0.02 - 50 amps, up to 480 VAC or 65 VDC, 1 - 4 poles (Handle), 1 - 3 poles (Rocker), with a choice of time delays.

Agency Certifications

UL Recognized

UL Standard 1077



Component Recognition Program as Protectors, Supplementary (Guide QVNU2, File E75596)

CSA Accepted



Component Supplementary Protector under Class 3215 30, File 047848 0 000 CSA Standard C22.2 No. 235

UL Standard 508



Switches, Industrial Control (Guide NRNT2, File E148683)

VDE Certified



EN60934, VDE 0642 under File No. 10537

Electrical

Table A: Lists UL Recognized, CSA Accepted and VDE Certified configurations and performance capabilities as a Component Supplementary Protector.

D-SERIES TABLE A: COMPONENT SUPPLEMENTARY PROTECTORS										
CIRCUIT CONFIGURATION	VOLTAGE			CURRENT RATING FULL LOAD AMPS	SHORT CIRCUIT CAPACITY (AMPS)				APPLICATION CODES	
	MAX. RATING	FREQUENCY	PHASE ¹		UL/CSA		VDE		UL	CSA
					WITH BACKUP FUSE	WITH BACKUP FUSE	(Inc) WITH BACKUP FUSE	(Inc) WITHOUT BACKUP FUSE		
SERIES	65	DC	—	0.02 - 50	—	5,000	5,000	1,500	TC1.2, OL1, U1	TC1.2, OL1, U1
	80	DC	—	0.02 - 50	—	5,000	5,000	1,500	TC1.2, OL1, U1	TC1.2, OL1, U1
	125 / 250	50 / 60	1	0.02 - 50	—	3,000	—	—	TC1.2, OL1, U1	TC1.2, OL1, U1
	250	50 / 60	1 & 3	0.02 - 50	5,000 ²	—	5,000	1,500	TC1.2, OL1, C1	TC1.2, OL1, C1
	277	50 / 60	1	0.02 - 50	5,000 ²	—	—	—	TC1.2, OL1, C1	TC1.2, OL1, C1
SWITCH ONLY	480 Y ³	50 / 60	1 & 3	0.02 - 50	5,000 ²	—	—	—	TC1.2, OL1, C1	TC1.2, OL1, C1
	65	DC	—	0.02 - 50	—	—	—	—	—	—
	250	50 / 60	3	0.02 - 50	—	—	—	—	—	—
	277	50 / 60	1	0.02 - 50	—	—	—	—	—	—
	480 Y ³	50 / 60	1 & 3	0.02 - 30	—	—	—	—	—	—

Notes for Table A:

- DC and 1Phase 277 V ratings are 1 or 2 poles breaking. Three phase ratings are 3 poles breaking.
- Requires branch circuit backup with a UL LISTED Type K5 or RK5 fuse rated 15A minimum and no more than 4 times full load amps not to exceed 150 A for 250V rating and 125 A for 277 and 480 V ratings.
- UL recognition and CSA Acceptance at 480 volts refers to 3 and 4 pole versions, used only in a 3 phase WYE connected circuit or 2 pole versions connected with 2 poles breaking 1 phase and backed up with series fusing per note 2.

Electrical

- Maximum Voltage AC, 480 wye/277 VAC (See Table A), 50/60 Hz, 65VDC
- Standard Current Coils 0.100, 0.250, 0.500, 0.750, 1.00, 2.50, 5.00, 7.50, 10.0, 15.0, 20.0, 25.0, 30.0, 35.0, 40.0 & 50.0. Other ratings available - consult factory.
- Standard Voltage Coils DC - 6V, 12V; AC - 120V, other ratings available, see ordering scheme.
- Insulation Resistance Minimum of 100 Megohms at 500 VDC.
- Dielectric Strength UL, CSA: 1960 V 50/60 Hz for one minute between all electrically isolated terminals. D-Series circuit breakers comply with the 8mm spacing and 3750V 50/60 Hz dielectric requirements from hazardous voltage to operator accessible surfaces and between adjacent poles per Publications EN 60950 and VDE 0805.
- Resistance, Impedance Values from Line to Load Terminal - based on Series Trip Circuit Breaker

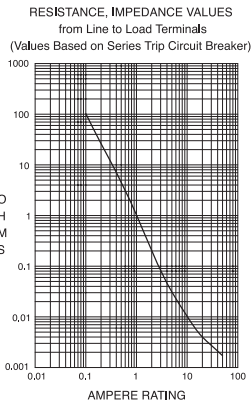

CURRENT (AMPS)	TOLERANCE (%)
0.10 - 5.0	15%
5.1 - 20.0	25%
20.1 - 50.0	35%

Pulse Tolerance Curves

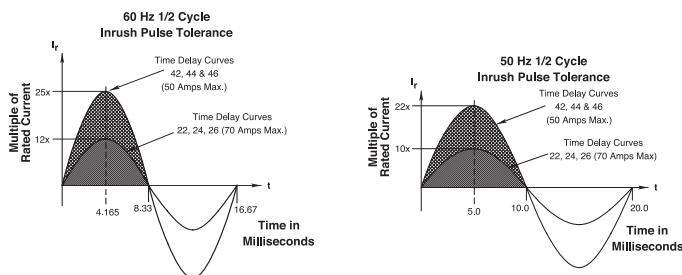

Mechanical

- Endurance 10,000 ON-OFF operations @ 6 per minute; with rated Current and Voltage.
- Trip Free All D-Series Circuit Breakers will trip on overload, even when actuator is forcibly held in the ON position.
- Trip Indication The operating actuator moves positively to the OFF position when an overload causes the breaker to trip.

Physical

- Number of Poles Rocker Type: 1-3; Handle Type: 1-4
- Internal Circuit Config. Switch Only and Series Trip with current or voltage trip coils.
- Weight Approximately 128 grams/pole (Approximately 4.57 ounces/pole)
- Standard Colors Housing - Black; Actuator - See Ordering Scheme.
- Mounting Mounts on a standard 35mm Symmetrical DIN Rail (35 x 7.5 or 35 x 15mm per DIN EN5002).

Environmental

- Designed and tested in accordance with requirements of specification MIL-PRF-55629 & MIL-STD-202 as follows:
- Shock Withstands 100 Gs, 6ms, sawtooth while carrying rated current per Method 213, Test Condition "I". Instantaneous and ultra-short curves tested @ 90% of rated current.
- Vibration Withstands 0.060" excursion from 10-55 Hz, and 10 Gs 55-500 Hz, at rated current per Method 204C, Test Condition A. Instantaneous and ultra-short curves tested at 90% of rated current.
- Moisture Resistance Method 106D, i.e., ten 24-hour cycles @ + 25°C to +65°C, 80-98% RH.
- Salt Spray Method 101, Condition A (90-95% RH @ 5% NaCl Solution, 96 hrs).
- Thermal Shock Method 107D, Condition A (Five cycles @ -55°C to +25°C to +85°C to +25°C).
- Operating Temperature -40° C to +85° C

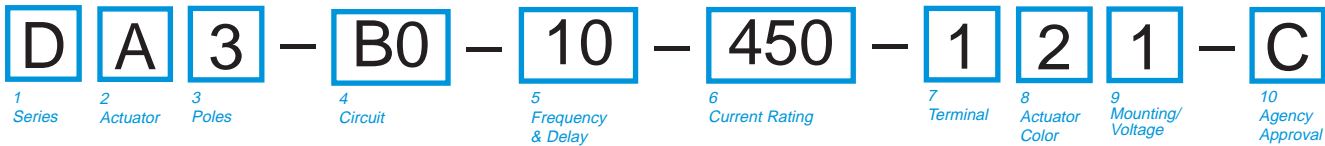

1 SERIES

D

2 ACTUATOR¹

Handle²

- A Handle, one per pole
- B Handle, one per multipole unit

Visi-Rocker³

- C Indicate ON, vertical legend
- D Indicate ON, horizontal legend
- E Indicate ON, no legend (VDE approval not available with no legend)
- F Indicate OFF, vertical legend
- G Indicate OFF, horizontal legend
- H Indicate OFF, no legend (VDE approval not available with no legend)

Single Color Rocker³

- J Vertical legend
- K Horizontal legend
- L No legend (VDE approval not available with no legend)

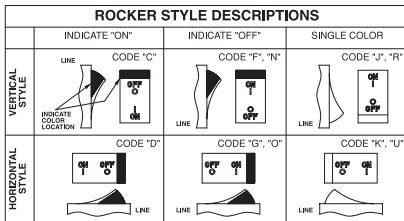

3 POLES

- 1 One
- 2 Two
- 3 Three
- 4 Four

4 CIRCUIT

- A0 Switch Only (No Coil) ⁴
- B0 Series Trip (Current)
- C0 Series Trip (Voltage)

5 FREQUENCY & DELAY

03	DC 50/60Hz, Switch Only	26	50/60Hz Long
10 ⁵	DC Instantaneous	32	DC, 50/60Hz Short
11	DC Ultra Short	34	DC, 50/60Hz Medium
12	DC Short	36	DC, 50/60Hz Long
14	DC Medium	42 ⁶	50/60Hz Short, Hi-Inrush
16	DC Long	44 ⁶	50/60Hz Medium, Hi-Inrush
20 ⁵	50/60Hz Instantaneous	46 ⁶	50/60Hz Long, Hi-Inrush
21	50/60Hz Ultra Short	52 ⁶	DC, Short, Hi-Inrush
22	50/60Hz Short	54 ⁶	DC, Medium, Hi-Inrush
24	50/60Hz Medium	56 ⁶	DC, Long, Hi-Inrush

6 CURRENT RATING (AMPERES)

020	0.020	280	0.800	460	6.000	619	19.000
025	0.025	285	0.850	465	6.500	620	20.000
030	0.030	410	1.000	470	7.000	621	21.000
050	0.050	512	1.250	572	7.250	622	22.000
075	0.075	413	1.300	475	7.500	623	23.000
080	0.080	414	1.400	480	8.000	624	24.000
085	0.085	415	1.500	485	8.500	625	25.000
210	0.100	517	1.750	490	9.000	626	26.000
215	0.150	420	2.000	495	9.500	627	27.000
220	0.200	522	2.250	610	10.000	628	28.000
225	0.250	425	2.500	710	10.500	629	29.000
230	0.300	527	2.750	611	11.000	630	30.000
235	0.350	430	3.000	711	11.500	632	32.000
240	0.400	532	3.250	612	12.000	635	35.000
245	0.450	435	3.500	712	12.500	640	40.000
250	0.500	436	3.600	613	13.000	645	45.000
255	0.550	440	4.000	614	14.000	650	50.000
260	0.600	445	4.500	615	15.000		
265	0.650	547	4.750	616	16.000		
270	0.700	450	5.000	617	17.000		
275	0.750	455	5.500	618	18.000		

OR VOLTAGE COIL (VOLTS, MIN. TRIP RATING⁵)

A06	6 DC, 5 DC	A48	48 DC, 40 DC	J24	24 AC, 20 AC
A12	12 DC, 10 DC	A65	65 DC, 55 DC	J48	48 AC, 40 AC
A18	18 DC, 15 DC	J06	6 AC, 5 AC	K20	120 AC, 65 AC
A24	24 DC, 20 DC	J12	12 AC, 10 AC	L40	240 AC, 130 AC
A32	32 DC, 25 DC	J18	18 AC, 15 AC		

7 TERMINAL

- 1 #10 Screw & Pressure Plate for Direct Wire Connection
- 2 #10 Screw without Pressure Plate

8 ACTUATOR COLOR & LEGEND

Actuator or Visi-Color	Marking:	Marking Color:	Single Color	Visi-Rocker (Actuator Black) ⁷
Color:	I-O	ON-OFF	Dual	Rocker/Handle
White	A	B	1	Black
Black	C	D	2	White
Red	F	G	3	White
Green	H	J	4	White
Blue	K	L	5	White
Yellow	M	N	6	Black
Gray	P	Q	7	Black
Orange	R	S	8	Black

9 MOUNTING/VOLTAGE

	MOUNTING STYLE	VOLTAGE
	Threaded Insert	
1	6-32 x 0.195 inches	< 300
C ⁸	6-32 X 0.195 inches	≥ 300
2	ISO M3 x 5mm	< 300
D ⁹	ISO M3 x 5mm	≥ 300

10 AGENCY APPROVAL

- C UL Recognized & CSA Accepted
- D⁹ VDE Certified, UL Recognized & CSA Accepted

Notes:

- 1 Handle breakers available up to four poles. Rocker breakers available up to three poles.
- 2 Actuator Code:
A: Multi-pole units factory assembled with common handle tie.
B: Handle location as viewed from front of breaker:
2 pole - left pole
3 pole - center pole
4 pole - two handles at center poles
- 3 Multipole rocker breakers have one rocker per breaker, as viewed from the front of the panel. Two pole - left pole. Three pole - center pole
- 4 ≤ 30A, select Current Rating code 630. 31-50A, select Current Rating code 650.
- 5 Voltage coil only available with delay codes 10 & 20.
- 6 Available to 50A max with circuit code BO only.
- 7 Color shown is visi and legend with remainder of rocker black.
- 8 ≥ 300V: Three pole breaker 3Ø or 2 pole breaker 1Ø, UL/CSA limited to 30 FLA max.
- 9 VDE Approval requires Dual (I-O, ON-OFF) or I-O markings

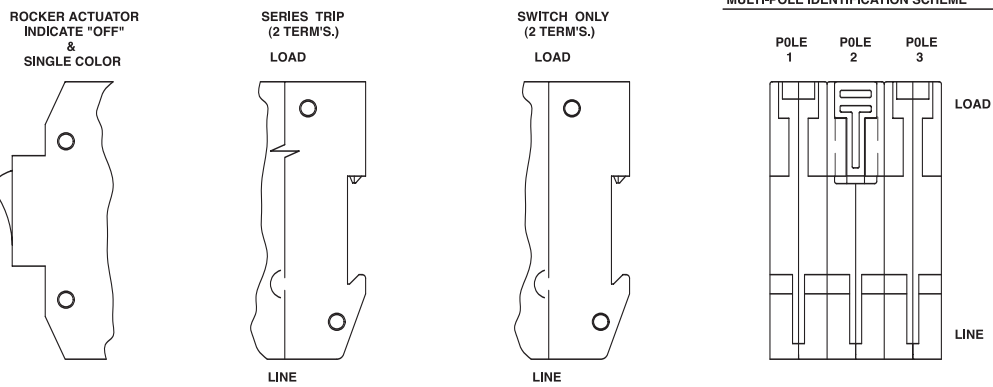
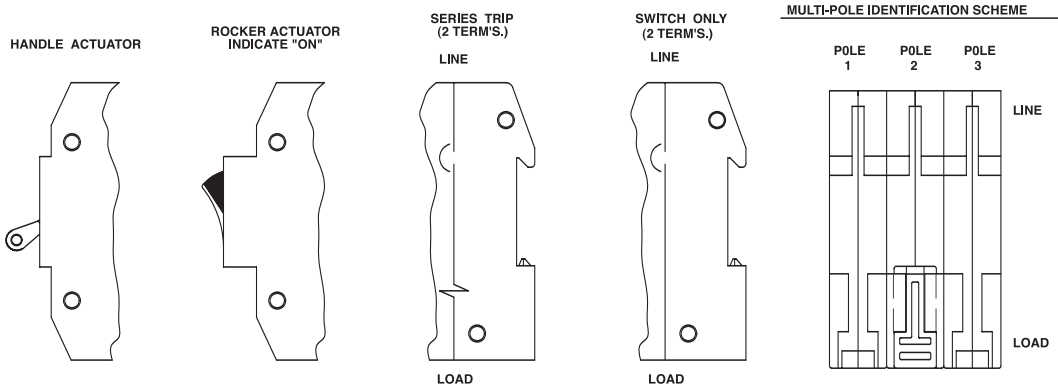

(HANDLE ACTUATOR SHOWN)

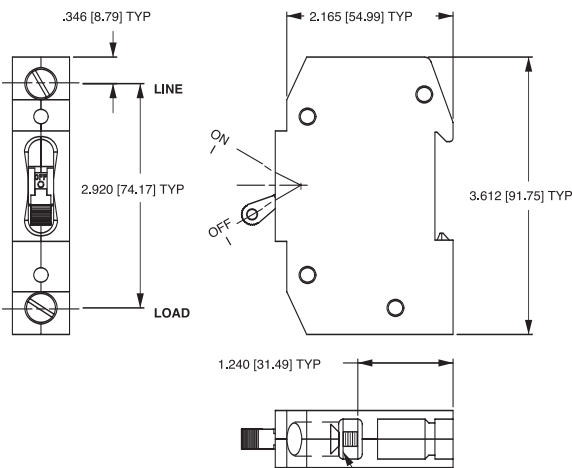
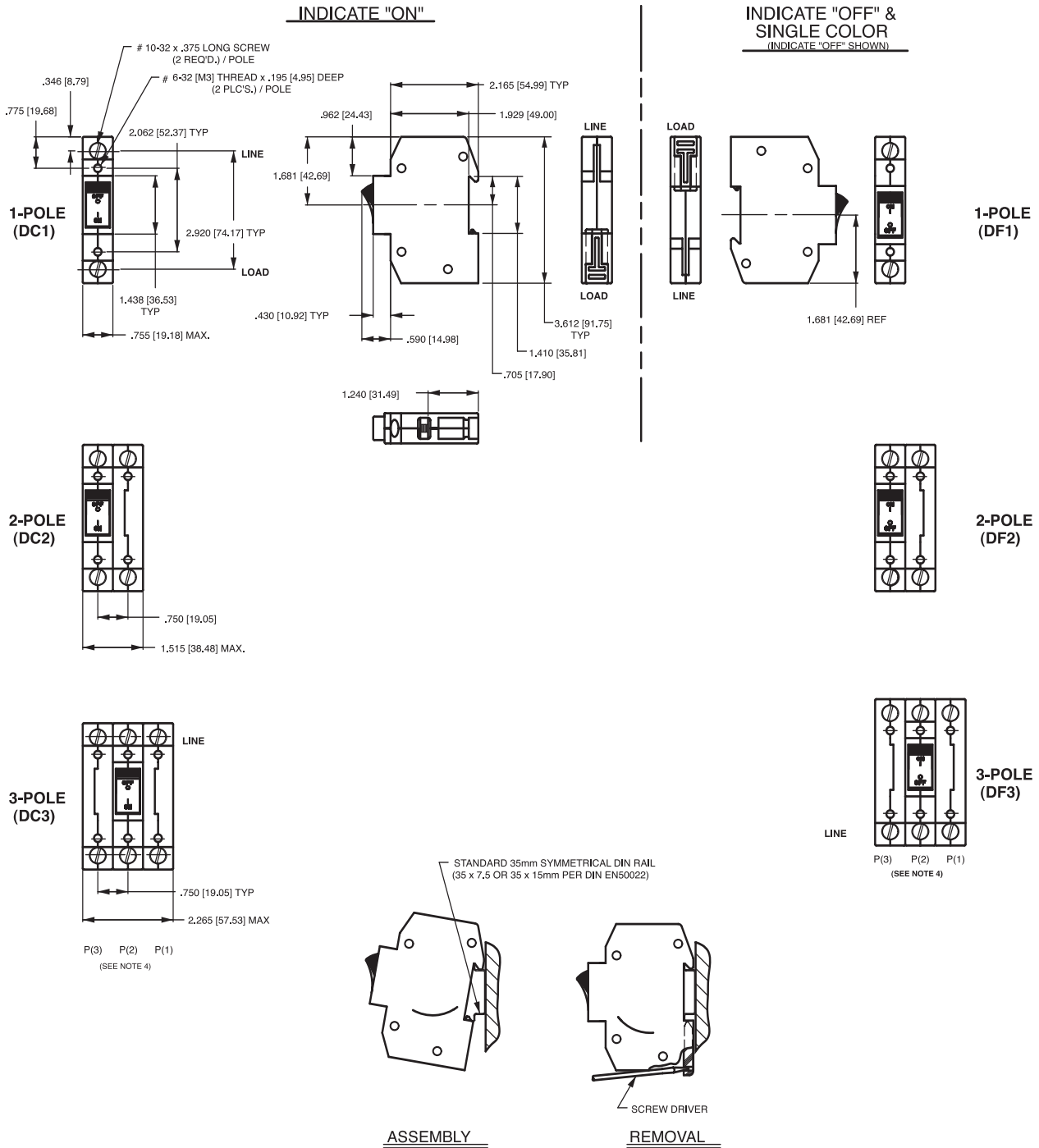

TABLE A	
TIGHTENING TORQUE SPECIFICATIONS	
THREAD SIZE	TORQUE
#6-32 [M3] HARDWARE	7-9 IN-LBS [0.8-1.0 NM]
#10-32 THD TERMINAL SCREW	15-20 IN-LBS [1.7-2.3 NM]

TERMINALS ARE SUPPLIED WITH #10-32 SCREW AND PRESSURE PLATE PER TERMINAL

Notes:

- 1 All dimensions are in inches [millimeters].
- 2 Tolerance $\pm .020$ [.51] unless otherwise specified.



Notes:

- 1 All dimensions are in inches [millimeters].
- 2 Tolerance $\pm .020$ [.51] unless otherwise specified.
- 3 Dimensions apply to all variations shown. Notice that circuit breaker line and load terminal orientation on indicate OFF is opposite of indicate ON.
- 4 For pole orientation with horizontal legend, rotate front view clockwise 90°.

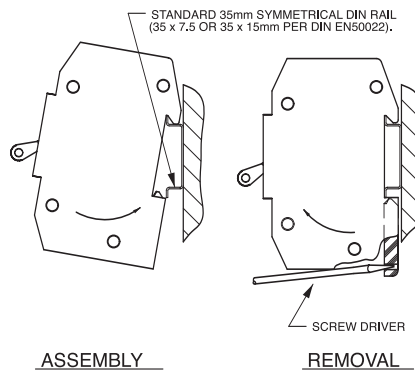
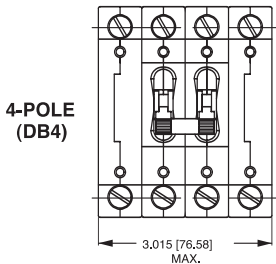
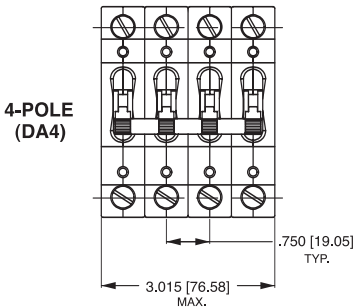
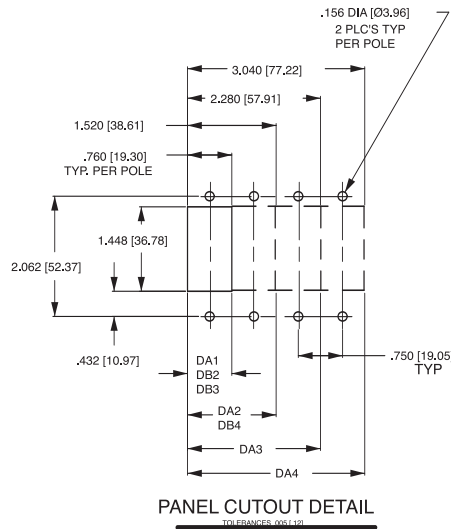
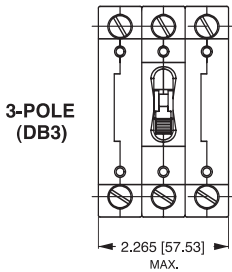
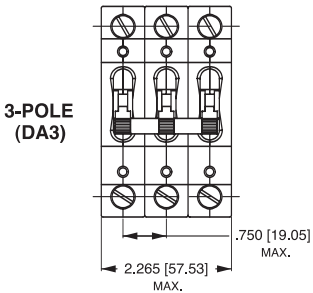
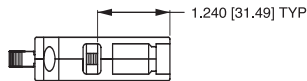
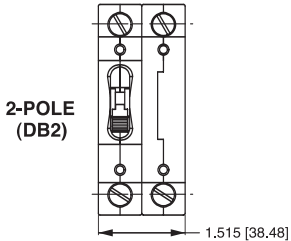
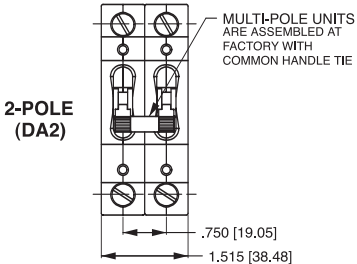
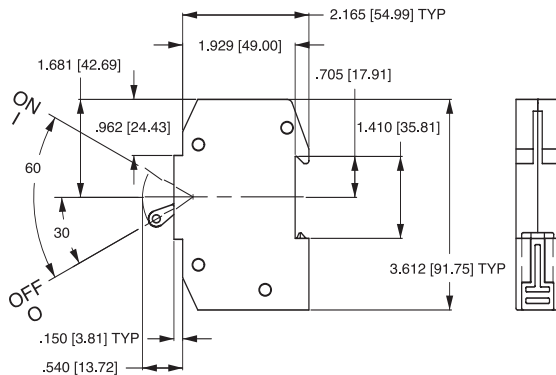
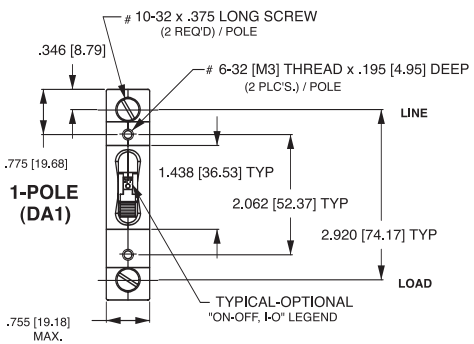

- Notes:
 1 All dimensions are in inches [millimeters].
 2 Tolerance ±.020 [.51] unless otherwise specified.