

WIRE PROCESSING SOLUTIONS

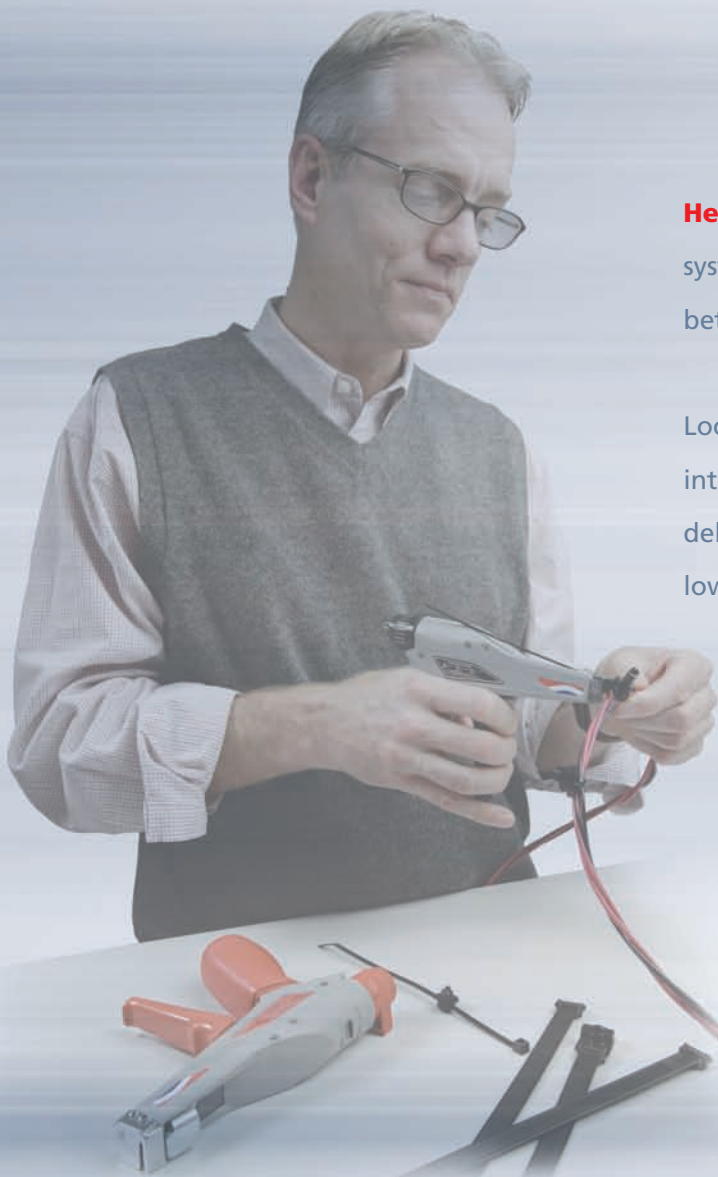

Automatic Cable Tie Tool Systems
Power-Assisted Cable Tie Tools
Mechanical Cable Tie Tools
Printing Systems
Labels

HellermannTyton



HellermannTyton is a leading, global manufacturer of systems and solutions which help world-class customers better manage and identify wire, cable, and components.

Located in over 30 countries, HellermannTyton offers an integrated approach in the design, manufacturing, and delivery of its products which result in higher quality and lower costs for our customers.

ARGENTINA | AUSTRALIA | AUSTRIA | BELGIUM | BRAZIL | CANADA | CHINA
CZECH REPUBLIC | DENMARK | FINLAND | FRANCE | GERMANY | HONG KONG
HUNGARY | IRELAND | ITALY | JAPAN | MEXICO | NETHERLANDS | NORWAY | PHILIPPINES
POLAND | PORTUGAL | ROMANIA | SINGAPORE | SLOVENIA | SOUTH AFRICA | SOUTH KOREA
SPAIN | SWEDEN | THAILAND | UNITED KINGDOM | UNITED STATES

Table of Contents



AUTOMATIC CABLE TIE SYSTEMS **4-12**

Overview	4
AT2000	5
AT2060	6
AT2000 and AT2060 Bench Mount System	7
AT2000 or AT2060 Overhead Suspension System	8
AT2000 Battery Pack	9
Wire Retainer for Harness Boards	9
AutoTool System 3080	10-11
Quick Tool	12



POWER ASSISTED CABLE TIE TOOLS **13-15**

Overview	13
Mark 7 Pneumatic	14
Mark 9 Pneumatic	15



MECHANICAL CABLE TIE TOOLS **16-18**

Overview	16-17
Mark 7	17
Mark 9	18
Other Mechanical Cable Tie Tools	18



IDENTIFYING **19-37**

Printing Systems

SwiftMark Automatic Label Printer and Applicator	19
Labeling Softwares	20
Spirit 2100 Portable Printing System	21
TT320SM Thermal Transfer Printer and Ribbons	22

Computer Printable Labels

Wire Diameter Guide	23
TipTags	24-25
ShrinkTrak Heat Shrinkable Markers	26-29
Thermal Transfer Self-Laminating Labels	30-31
Self-Laminating Laser Tags	32-33

Index

Index by Part No.	34
Index by Article No.	35

HellermannTyton Systems

As an industry leader in the development and manufacture of cable tie installation tools and identification solutions, HellermannTyton provides a sustainable and distinctive competitive advantage to its customers through automation and process improvements. These improvements increase flexibility while exceeding labor savings, quality and ergonomic objectives. With its diverse line of products, HellermannTyton provides a complete package unique to the needs and production requirements of its customers.—

▶ *HellermannTyton systems offer significant contributions to greater productivity, safety, and the “bottom-line.”*

- **Lower Installed Costs**
- **Reduce Labor Costs**
- **Improve Quality & Consistency**
- **Reduce Repetitive Motion Disorders**

Superior Service and Support

HellermannTyton offers support to meet the individual needs of the customer. Expert technicians are available for on-site training and an in-house team of service specialists provide telephone and online technical support. HellermannTyton is able to provide optimal service levels to eliminate downtime and enhance productivity.



“The support is top notch. They have never let me down.

The operators love this tool. It is easy to handle... the balance of the tool is perfect.”

CUSTOM CABLE & WIRE HARNESS MANUFACTURER

“We’re putting out the same production with half the people. We’re able to do with one person in the same amount of time what required two people to do before. And there is much higher reliability of the equipment.”

SENIOR MANUFACTURING ENGINEER,
MANUFACTURER OF INDUSTRIAL AND
COMMERCIAL CONTROLS

Cable Ties and Tool Systems

HellermannTyton's cable tie and tool systems are designed to work together to provide optimal consistency, quality, safety, and overall performance. Wrapping and hand tensioning a high quality cable tie is just the first step in assuring a high quality application. It is necessary to use one of HellermannTyton's cable tie tools to ensure that the cable tie is applied with just the right amount of tension and with a flush cut that won't leave a sharp edge. HellermannTyton leads the world in the development and manufacture of ergonomically designed, high performing cable tie tools in mechanical, power assisted, and automatic versions. With HellermannTyton's automatic cable tie systems, cable ties are applied, tensioned and cut-off to the correct tension in approximately one second. HellermannTyton's mechanical and power assisted tools expertly tension and cut-off hand applied cable ties.



AT2000 Automatic Cable Tie Tool — For automatic cable tie tool systems, see page 4

Consistency and Quality

By utilizing HellermannTyton's cable ties and tools together, a consistent tension and cut-off is achieved. When using non-approved methods of cutting off a cable tie, wire and cable can be crushed, the strap of the cable tie may be cut-off too deeply causing the tie to disengage, or the cable tie can be applied too loosely which can affect the bundling and securing properties of the application.

Safety

A flush cut is another benefit of using HellermannTyton's cable tie tools and ties as a system. Worker safety, and resulting reduction of workers' compensation claims, is an increasing priority of most companies. HellermannTyton's cable tie tools are ergonomically designed to reduce worker effort and causes of repetitive motion injuries. When using HellermannTyton's tools and cable ties, a flush cut is achieved, creating a smooth edge. When non-approved methods of applying a cable tie are used, a sharp edge is almost always left at the end of the tie - causing injury to workers and end-customers. All of HellermannTyton's cable tie tool systems offer adjustable tension and cut-off levels to assure optimal tensions and flush cut-offs.

Overall Performance

Used together, HellermannTyton's cable ties and ergonomically designed tool systems assure a high quality installation which prevents damage to wire and cable and potential rework due to inappropriately applied cable ties - all lowering installed costs while improving performance.



MK7P - Power Assisted Cable Tie Tool — For power assisted cable tie tools, see page 13



MK7 and MK9 Mechanical Cable Tie Tools — For mechanical cable tie tools, see page 16.

Automatic Cable Tie Systems

HellermannTyton's automatic cable tie tool systems are compact, fast, reliable, and versatile, accommodating a variety of wiring harness, and bundling and securing requirements. These tool systems are designed to provide significant labor and cost savings through process improvements, lower installed costs and greater consistency, quality and ergonomic benefits.

Product Features

- Fast

Cable ties are installed quickly with one easy trigger depression, increasing productivity while decreasing labor costs.

- Reliable

HellermannTyton's automatic cable tie systems have been tested to perform extremely consistently without interruption to work flow.

- Ergonomic

The ergonomic design of the automatic cable tie tool systems feature a comfortable grip, low weight, and easy trigger depression to reduce installer effort and strain while installing cable ties.

- Easy to Use - Providing Valuable Operator Feedback

Equipped with a self-diagnostic LED information panel, the automatic cable tie systems easily guide the user through the cycles of cable tie installations.

- Automation

The automatic cable tie systems can be implemented into fully automated applications to further increase productivity and decrease labor costs.

- Flexible Manufacturing/Versatility

HellermannTyton's automatic cable tie tool systems support principles of flexible manufacturing requirements and environments. The systems can be used in handheld, bench mount and overhead assembly configurations. The versatile overhead assembly option provides the ultimate integration to the customer's manufacturing area. HellermannTyton's automatic tools are powered by a standard 110 AC 24V (AT2000) and 110 AC 27 V (AT2060) electrical outlet that converts to a low DC voltage to the tool. All power systems offer the installer the mobility needed to tackle different harnessing requirements.

- Uniform Fastening Quality

HellermannTyton's automatic cable tie systems feature adjustable tension control to deliver consistent levels of cable tie fastening.

- Range

HellermannTyton offers the widest range of automatic cable tie tool systems which cover cable tie tensile strengths of 18, 30, and 50 pounds with bundle diameters between 1/16" to over 3".



ATS3080



An LED panel shows the status of the tool.

Product Selection		
Article No.	Part No.	Max. Ø Bundle
120-00000	AT2000	.75" (20 mm)
103-00000	AT2060	1.25" (31 mm)
102-00000	ATS3080	3.14" (80 mm)

Automatic Cable Tie Tool Systems

AT2000**For bundles up to 3/4"**

HellermannTyton's AT2000 completely installs cables ties on bundles up to 3/4" in diameter. This automatic cable tie tool is highly reliable and offers ergonomic benefits including low weight, easy trigger depression, a comfortable hand grip and correct balance—all which reduce operator strain. The AT2000 possesses an LED panel which makes it easier to maintain and operate the tool.



AT2000 Technical Specifications

Power Supply	Electrical, with Power Pack or Battery Pack
Cycle Time	0.8 s
Weight	2.6lbs
Installation	Handheld, bench mount or overhead
Tension Force	Adjustable

AT2000 Cable Tie Specifications

Operating Temperature	
Natural Polyamide 6.6	-40 °F to +185 °F (-40 °C to +85 °C) continuous
Heat stabilized, black Polyamide 6.6	-40 °F to +221 °F (-40 °C to +105 °C) continuous
Natural, Stanyl Polyamide 4.6	-40 °F to +275 °F (-40 °C to +135 °C) continuous
Reel Diameter	17.7 " (450)
Reel Width	5.20 " (132)

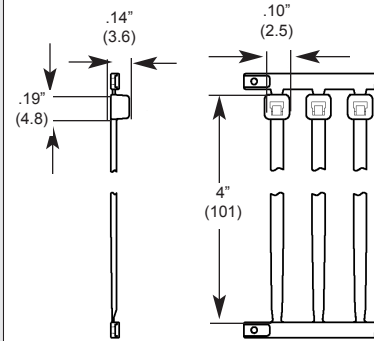

AT2000 Cable Ties



File# E64139

Product Selection

Article No.	Part No.	Type	Description	Min. Tensile Strength	Max. Ø Bundle	Pkg. Qty.
				lbs. (N)	in. (mm)	
120-00000	AT2000	Autotool 2000	Includes AT2000 tool, power supply, power cord, tool cord, and manual			1
120-00060	120-00060	Control Box	Control Box for linking AT2000 to automation			1

Natural Cable Ties

120-40009	T18RA50	T18RA50-N66-NA	Cable ties on bandolier for use with the AT2000	18 lbs (80)	.75" (20)	20,000 per carton includes: 50 per bandolier 500 per package
120-46009	T18RA3500	T18RA3500-N66-NA	Cable ties on reel for use with the AT2000	18 lbs (80)	.75" (20)	14,000 per carton includes: 3,500 per reel 4 reels per carton
120-05009	T18RA5000	T18RA5000-N66-NA	Cable ties on reel for use with the AT2000	18 lbs (80)	.75" (20)	10,000 per carton includes: 5,000 per reel 2 reels per carton

Black, Heat Stabilized Cable Ties

120-40010	T18RA50HSW	T18RA50-HSW-BK	Cable ties on bandolier for use with the AT2000	18 lbs (80)	.75" (20)	20,000 per carton includes: 50 per bandolier 500 per package
120-05010	T18RA5000HSW	T18RA5000-HSW-BK	Cable ties on reel for use with the AT2000	18 lbs (80)	.75" (20)	10,000 per carton includes: 5,000 per reel 2 reels per carton

Natural, Stanyl Cable Ties

120-04609	T18RA5000HR	T18RA5000HR-N46	Cable ties on reel for use with the AT2000	18 lbs (80)	.75" (20)	10,000 per carton includes: 5,000 per reel 2 reels per carton
-----------	--------------------	-----------------	--	-------------	-----------	---

V/O rated ties can be made available for the AT2000. Various tie colors available upon request (Contact HellermannTyton for lead time). Dimensions are approximate and subject to technical changes. Use **Part No.** for ordering and **Type** for specification purposes.

For information on AT2000's Bench Mount System and Overhead Suspension Assembly see page 7-8.

For information on Wire Retainers for Harness Boards and AT2000's battery pack see page 9.

Automatic Cable Tie Tool Systems

AT2060

HellermannTyton's AT2060 automatically installs cable ties for bundles up to 1-1/4". The many ergonomic benefits include easy trigger depression and low weight that reduces operator effort and strain. Operation and maintenance of the tool are enhanced by the self-diagnostic LED panel located on the AT2060.



AT2060 Technical Specifications	
Power Supply	Electrical
Cycle Time	1.2 seconds
Weight	3.9lbs
Pawl Travel	1.25"
Stroke	(3.175 cm)
Tension Force	Adjustable

AT2060 Cable Tie Specifications	
Operating Temperature	
Natural Polyamide 6.6	-40 °F to +185 °F (-40 °C to +85 °C)
Heat stabilized, black, Polyamide 6.6	-40 °F to +221 °F (-40 °C to +105 °C)
Reel Diameter	17.7 " (450)
Reel Width	7.197 " (182.8)
Reel Weight	7 lbs

RoHS

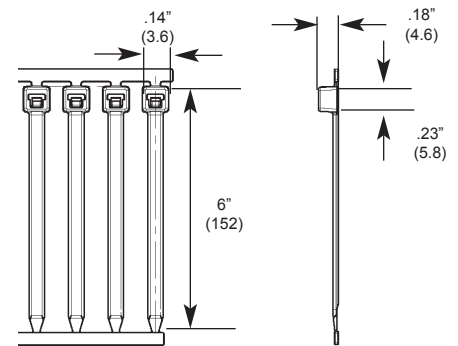

Product Selection						
Article No.	Part No.	Type	Description	Min. Tensile Strength	Max. Ø Bundle	Pkg. Qty.
				lbs. (N)	in. (mm)	
103-00000	AT2060	AT2060	Includes AT2060 tool, power supply, power cord, tool cord, and maintenance and operation manual.			1

Natural Cable Ties

103-00002	T30RA30	T30RA	Cable ties on a bandolier for use with the AT2060 tool	30 lbs (133.44)	1.25" (31)	6,000 per carton includes: 30 per bandolier 600 per bag
103-00001	T30RA3000	T30RA3000	Cable ties on a reel for use with the AT2060 tool	30 lbs (133.44)	1.25" (31)	6,000 per carton includes: 3,000 per reel 2 reels per carton

Black, Heat Stabilized Cable Ties

103-00003	T30RA300HS	T30RA	Cable ties on a bandolier for use with the AT2060 tool	30 lbs (133.44)	1.25" (31)	6,000 per carton includes: 30 per bandolier 600 per bag
103-00004	T30RA3000HS	T30RA	Cable ties on a reel for use with the AT2060 tool	30 lbs (133.44)	1.25" (31)	6,000 per carton includes: 3,000 per reel 2 reels per carton

Dimensions are approximate and subject to technical changes. Use **Part No.** for ordering and **Type** for specification purposes. V/O rated ties and 4/6 ties for high temperatures can be made available for the AT2060. Various colors available upon request (Contact HellermannTyton for lead time).

For information on AT2060's Bench Mount System and Overhead Suspension Assembly see page 7-8

For information on Wire Retainers for Harness Boards see page 9

AT2000 & AT2060 Bench Mount System

HellermannTyton offers a portable bench mount system which works with the AT2000 and AT2060 tool systems. It is extremely easy to set up and use. Within seconds, the AT2000 or the AT2060 can be converted from a handheld tool to a bench mount system. With the touch of the foot pedal, the cable tie is applied.



AT2000 and AT2060 Bench Mount System

Product Selection				
Article No.	Part No.	Type	Description	Pkg. Qty.
120-00040	AT2BENCHMOUNT	Bench Mount Kit	Includes foot pedal, tie reel stand and tool mounting stand	1

Use **Part No.** for ordering and **Type** for specification purposes.

Automatic Cable Tie Tool Systems

AT2000 or AT2060 Overhead Suspension Assembly

HellermannTyton's overhead suspension assembly system holds the AT2000 or AT2060, reel of cable ties, and power source. The overhead assembly is available in several configurations in a variety of mounting options and is easily integrated into various manufacturing environments. The modular design allows for easy additions or modifications of the system design.

The overhead assembly system provides additional ergonomic advantages to the AT2000 and AT2060. The system features overhead hanging, a trolley slide which allows for mobility within the frame, and an adjustable counter balance. These features allow for low operator strain and easy use. Since the assembly integrates the automatic cable tie systems and reel of ties, continuous feed is achieved. Reloading of cable ties is greatly reduced, further optimizing efficiencies.



The picture shows just one configuration of an overhead assembly.

The HellermannTyton team of tool systems specialists will assist in the custom design of a system to specially accommodate individual manufacturing sites and production needs. The modular features and inherent ergonomic benefits improve production and make operation more efficient.

Contact HellermannTyton for more information. Fasteners for unit assembly are included. Permanent mounting fasteners are not included.



Mobile Trolley Unit Configuration

AT2000 Battery Pack

HellermannTyton's battery pack powers the AT2000 and is worn by the operator, allowing for complete mobility.



Product Selection				
Article No.	Part No.	Type	Description	Pkg. Qty.
120-00030	AT06500030	Battery Pack	Battery with belt clip and connector cord	1
120-00010	AT06500020	Battery Charger	Charging unit for battery	1

Dimensions are approximate and subject to technical changes. Use **Part No.** for ordering and **Type** for specification purposes.

Wire Retainer for Harness Boards

Designed for use in harness board assemblies, these wire retainers stand-off wire and cable bundles for easier cable tie application. Wires are individually inserted, and bundles are preformed, making harnessing easier.

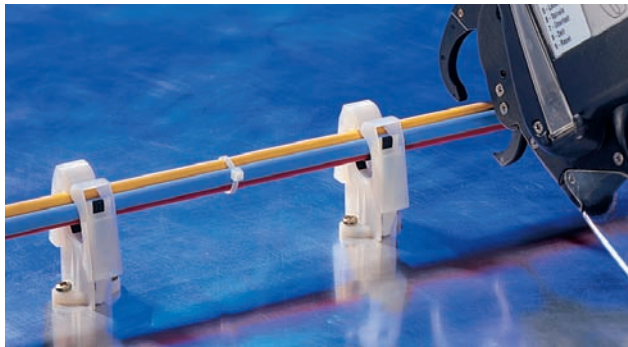

Wire Retainer for Harness Boards

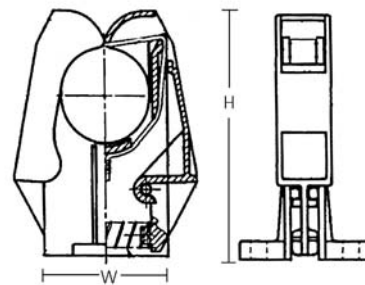

Product Selection					Height (H)	Width (W)	Max. Ø Bundle	Pkg. Qty.
Article No.	Part No.	Type	Description	in. (mm)	in. (mm)	in. (mm)		
120-00080	HH-20	HH20	Harness Board Assembly	2.12" (54)	1.22" (31)	.83" (20)	25	

Dimensions are approximate and subject to technical changes. Use **Part No.** for ordering and **Type** for specification purposes.

Automatic Cable Tie Tool Systems

AutoTool System 3080

For bundles up to 3.14"

HellermannTyton's ATS3080 automatically installs cable ties for bundles up to 3.14" in diameter with one trigger depression. This innovative system utilizes strap and closures (ordered separately) to achieve a waste free system. The ATS3080 uses only the required strap length required for the diameter. The strap is outside serrated so that it will not damage sensitive wire and cable bundles.

This well balanced tool has ergonomic benefits that include low weight and a comfortable hand grip which reduces operator strain and injury while installing cable ties. The ATS3080 possesses a LED panel that provides critical operational feedback that makes it easier to maintain and operate the tool.

The ATS3080 has three jaw diameters available; 1.18" (30mm), 1.96" (50mm), and 3.14" (80mm). The jaws are easily interchanged and further tool adjustment between the three jaw diameters is unnecessary.



ATS3080 Technical Specifications

Power Supply	Electrical
Cycle Time	approx. 1.3 sec. (50 mm jaw)
Weight	3.2lbs
Installation	Mobile, bench mount or overhead
Tension Force	Adjustable



Closures and strap for ATS3080



ATS3080 Cable Tie Specifications

Material	Polyamide 6.6 high impact modified, heat and UV stabilized (PA66HIRHSUV)
Operating Temperature	-40 °C to +95 °C continuous, (+105 °C for 5000 h)
Flammability	UL94 HB
Strap Reel Dimensions	
Reel Diameter	15.25" (387 mm)
Reel Width	3.5" (88.9 mm)
Reel Weight	6lbs (2.72 kg)
Closure Reel Dimensions	
Reel Diameter	15.25" (387 mm)
Reel Width	3.5" (88.9 mm)
Reel Weight	3.5lbs (1.58 kg)



Automatic Cable Tie Tool Systems



ATS3080 with mobile trolley unit



ATS3080 with overhead



ATS3080 with bench mount

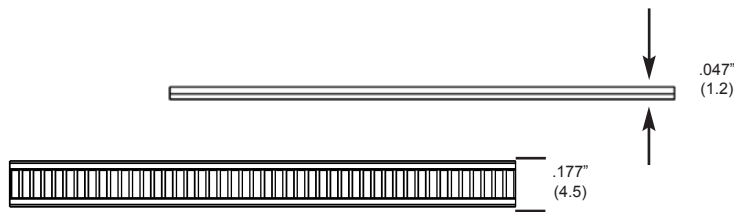

Strap ATS3080

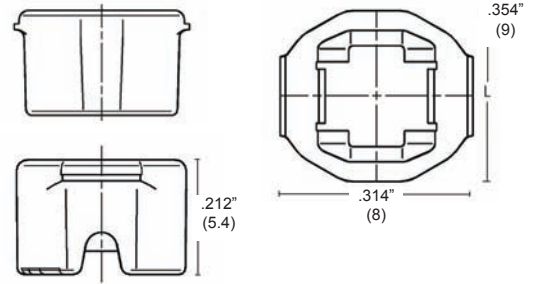

Closures ATS3080

Product Selection					
Article No.	Part No.	Type	Description	Min Tensile Unlocking Strength (lbs)	Pkg. Qty. ft. (m)
102-00000	ATS3080	ATS3080	Includes ATS3080 tool, power cord, tool cord, and maintenance and operation manual. Does not include power supply.		1
102-00010	ATS10200010	Power Pack ATS3080	Power Supply Unit for ATS3080 Input: 230/115 VAC, 50-60 Hz Output: 48 VDC, max. 50W		1
Natural Strap and Closures					
102-66109	ATS10266109	Strap Natural ATS3080	ATS3080 Strap	50 lbs	1640 ft. (500)
102-66209	ATS10266209	Closures Natural ATS3080	ATS3080 Closure	50 lbs	5000 pcs
Black Strap and Closures					
102-66110	ATS10266110	Strap Black ATS3080	ATS3080 Strap	50 lbs	1640 ft. (500)
102-66210	ATS10266210	Closures Black ATS3080	ATS3080 Closures	50 lbs	5000 pcs
102-00040	ATS10200040	Bench Mount Kit	Bench Mount Kit for ATS 3080 Integrated pneumatic system that coordinates tool and reels. Foot pedal application, other actuation options available		1
102-00050	ATS10200050	Overhead Suspender	Overhead Suspender ATS 3080		1
102-00030	ATSTROLLEY	Trolley ATS 3080	Trolley		1

Dimensions are approximate and subject to technical changes. Use **Part No.** for ordering and **Type** for specification purposes.

Automatic Cable Tie Tool Systems

Quick Tool

HellermannTyton's Quick Tool is an automatic bench mount system suited for high volume cable tie applications. This air powered tool accommodates a reel of 5,000 ties and, like HellermannTyton's other automated systems, can be integrated into further automation as well as fully incorporated into conveyor or assembly line applications.

Product Features

- The system is a one piece, bench top unit which increases efficiency through quick and reliable fastening.
- It can be installed where a 110 VAC electrical outlet and pneumatic air source are available.
- Provides consistent fastening tension.
- Controls fastening tension.
- Ties are available in two styles: standard and heat stabilized.
- Custom colors for Quick Tool ties are also available. Contact HellermannTyton for more information.



QS101 Cable Tie Specifications

Operating Temperature	
Natural	-40 °F to +185 °F (-40 °C to +85 °C)
Polyamide 6.6	
Heat stabilized, black, Polyamide 6.6	-40 °F to +221 °F (-40 °C to +105 °C)
Reel Diameter	18" (457 mm)
Reel Width	5.20" (132 mm)
Reel Weight	4.8 lbs (2.18 kg)



QS101 Technical Specifications

Max. Ø Bundle	0.630" (16.00 mm)
Wattage	70W
Power Supply	Electrical/Pneumatic Power
Cycle Time	1.2 Seconds
Weight	40 lbs.
Installation	Bench
Tension Force	Adjustable (9.92 lbs - 19.84 lbs)

Product Selection

Article No.	Part No.	Type	Description	Min Tensile Unlocking Strength (lbs)	Max. Ø Bundle	Width (W)	Length (L)	Pkg. Qty.
					in. (mm)	in. (mm)	in. (mm)	
105-00000	QS101	QS101	Includes Quick Tool, power cord, maintenance and operation manual and foot pedal.					1

Natural Cable Ties

105-00006	QTTIE9	QTTIE9	Cable ties on reel for use with the Quick Tool.	18	.63" (16)	.10" (2.5)	4.0" (101)	10,000 per carton: 5,000 per reel 2 reels per carton
-----------	---------------	--------	---	----	-----------	------------	------------	---

Black Heat Stabilized Cable Ties

105-00001	QTTIEOHS	QTTIEOHS	Cable ties on reel for use with the Quick Tool.	18	.63" (16)	.10" (2.5)	4.0" (101)	10,000 per carton: 5,000 per reel 2 reels per carton
-----------	-----------------	----------	---	----	-----------	------------	------------	---

Dimensions are approximate and subject to technical changes. Use **Part No.** for ordering and **Type** for specification purposes.

Various colored cable ties available upon request. Contact HellermannTyton for more information and lead times.

Power Assisted Cable Tie Tools

HellermannTyton's Mark 7 and Mark 9 power assisted (MK7P & MK9P) tools utilize pneumatic power to tension and cut-off HellermannTyton cable ties. The MK7P and MK9P tools feature an ergonomic design while offering time/labor savings and ease of use benefits derived from pneumatic power. These tools feature a non-slip, comfortable grip, soft touch trigger, and one touch tensioning/cut-off capability. HellermannTyton's pneumatic cable tie tools are lightweight, high performance, and suited for extended use.

Product Features

- Ergonomic

The ergonomic design of the pneumatic cable tie tools incorporates a comfortable grip, low weight, and easy trigger depression to reduce installer effort and strain while installing cable ties.

- Operation

MK7P & MK9P speed assembly. Just one pulse of the soft touch trigger assembly actuates an immediate tension and cut-off of the cable tie.

- Cable tie waste is ejected to the side after the cable tie is applied, ensuring smooth operation of the tool.
- Uses dry or lubricated air.
- Operates between 90 PSI and 105 PSI maximum.
- Supplied with a 6 inch lead which comes with a male quick connect fitting with a female coupler for 1/8" flow.

- Design

HellermannTyton's pneumatic tools are manufactured with tough, chromium steel components and high impact, glass reinforced nylon housings for maximum durability.

- Tensioning

An easy to read indicator verifies tension settings. The tools feature an easy dial-in tension adjustment, along with a lock-out capability. The tension adjustment on the MK7P and the MK9P is designed with an operator friendly, positive "click" design for easy use. The tension can readily be locked out to allow the tension adjustment to remain at a constant setting that can only be changed by approved personnel. The fine adjust tension knob has a unique lever feature used to reduce adjustment torque.



MK9P

Power-Assisted Cable Tie Tools

Mark 7 Pneumatic

The Mark 7 Pneumatic (MK7P) is built to perform in demanding production and manufacturing environments. Heavy duty precision parts ensure repeatability in the tensioning process. The MK7P fits comfortably in the operator's hand, reducing hand, arm and wrist fatigue. Due to its ergonomic features, HellermannTyton's MK7P makes it easier for the installer to consistently apply cable ties while maintaining correct tension and flush cut-off. Safety is enhanced, as the MK7P can eliminate sharp edges of a cut-off cable tie.



MK7P

Material Data	
Power Supply	Dry or lubricated air
Cycle Time	4 strokes per second
Weight	16oz
Pawl Travel Stroke	1.0" (2.54 cm)
Tension Force	60 to 170 N, adjustable

Product Selection					
Article No.	Part No.	Type	Description	Cable Tie Series	Pkg. Qty.
110-07101	MK7P	MK7P	Includes Mark 7 Pneumatic tool and quick connect fittings. Ergonomic tool uses pneumatic power and accomplishes rapid tension and cut-off with one trigger depression.	T18 thru T50 Series CTT20 thru CTT60 Series	1
110-07111	MK7P-342	Replacement Blade	MK7P Replacement Blade		1

Dimensions are approximate and subject to technical changes. Use **Part No.** for ordering and **Type** for specification purposes.

Minimum order quantity for MK7P-342 is 5.

MK9 Pneumatic

The Mark 9 Pneumatic (MK9P) is constructed with heavy duty parts to ensure that it performs optimally in demanding environments. It is ideally designed to apply heavy-duty ties (T50-T250), clamp and button head ties.

Like the MK7P, HellermannTyton's MK9P incorporates the next level of ergonomic improvement with its low weight, comfortable grip and easy trigger depression. Very durable, the pneumatic MK9P features adjustable, easy to read tension settings. Lock-out features are available.

The MK9P is available with lower air attachment (standard) or can be ordered with an upper air attachment.

Material Data	
Power Supply	Dry or Lubricated Air
Cycle Time	2 strokes per second
Weight	32oz
Pawl Travel Stroke	1.25" (3.175 cm)
Tension Force	60 to 170 N, adjustable



MK9PUA (Upper Air)



MK9P

Product Selection

Article No.	Part No.	Type	Description	Cable Tie Series	Pkg. Qty.
110-09101	MK9P	MK9P	Includes Mark 9 Pneumatic tool and quick connect fittings. Included is a 1/8" flow quick disconnect fitting and a 10" whip and 1/8" make fitting. Ergonomic tool uses pneumatic power and accomplishes rapid tension and cut-off with one trigger depression.	T50 thru T250 Series CTT20 thru CTT175 Series EL-TY Series Button Head Ties	1
110-09112	MK9PUA	MK9P	Includes Mark 9 Pneumatic tool with upper air option for top air connection. Supplied with a 1/8" flow quick disconnect fitting and a 10" whip and 1/8" quick disconnect fitting. Includes a hanger for an optional overhead tool balancer (not included). Ergonomic tool uses pneumatic power and accomplishes rapid tension and cut-off with one trigger depression.	T50 thru T250 Series CTT20 thru CTT175 Series EL-TY Series Button Head Ties	1
110-09111	MK9P-109	MK9P-109	MK9P Replacement Blade		1**

Dimensions are approximate and subject to technical changes. Use **Part No.** for ordering and **Type** for specification purposes.

**Minimum order quantity of MK9P-109 is 5.

Common Accessories for MK7P and MK9P

HellermannTyton offers a portable kit that incorporates carbon dioxide (CO₂) as the primary air source. This unique feature will allow for greater flexibility and the elimination of air line to the tool.

Product Selection

Article No.	Part No.	Type	Description	Pkg. Qty.
110-09002	MKPCOKIT	MKPCOKIT	MKPCOKIT is a complete kit that includes the belt, holster, hose/regulator, pouch and 16oz air tank.	1
110-09003	MKPCOTANK	MKPCOTANK	Standard 16oz air tank for CO ₂ air supply to tool.	1
110-09004	MKPCOTANK20	MKPCOTANK20	Special 20oz canister tank for CO ₂ feature.	1
110-09005	MKPCOHOSE	MKPCOHOSE	Hose attachment from air tank to the tool with regulator.	1
110-09006	MKPCOBELT	MKPCOBELT	Adjustable belt for air tank and pouch and tool holster for MK7P or MK9P tools.	1

Dimensions are approximate and subject to technical changes. Use **Part No.** for ordering and **Type** for specification purposes.

Mechanical Cable Tie Tools

Mechanical Cable Tie Tools



Ranging from the high performance Mark 7 and Mark 9 series tools to pocket-sized twist tools, HellermannTyton offers a range of mechanical tools which can be used with any HellermannTyton cable tie. When using these tools, the cable tie is hand applied and then manually tensioned and cut-off, without the use of an extraneous power source.

MARK 7 AND MARK 9 TOOLS

Specifically developed for maximum ergonomic and performance values, the Mark 7 and Mark 9 series tools combine reduced hand effort and durable components to ensure efficient assembly and a longer life cycle. The Mark 7 tools are used with T18 through T50 series HellermannTyton cable ties. The Mark 9 tools can be used with nearly every HellermannTyton cable tie. Able to accommodate ties to .530" in width, the Mark 9 is used with HellermannTyton's T18 series cable ties to the heavy duty ties, including the T250 series, Wide Strap series and EL-TY. High tension versions of both the Mark 7 and Mark 9 tools (MK7HT and MK79HT) offer the same design features as their standard counterparts but with higher cut-off tension capabilities. The Mark 9 and Mark 7 high tension tools both offer a 5/8" stroke.



MK7 & MK9

Mark 7 and Mark 9 Features

- An easy to read display speeds adjustment and verification.
- Thumb tab on larger tension knob for easy adjustment.
- On the Mark 7, a larger knob sets the three variable tension levels (minimum, intermediate, and standard). The smaller knob fine tunes within the tension range.
- The larger knob on the Mark 9 sets to two variable tension levels (standard and heavy). The smaller knob fine tunes the tension setting.
- Housings are manufactured from a high impact, glass reinforced nylon.
- A double wall linkage adds more strength.
- Tough chromium steel components ensure longevity.
- MK7 & MK9 are military specified.
- Single and dual lock-out features available for tensioning ranges.
- Cable tie tension and cut-off tools reduce operator fatigue and speed assembly.
- The Mark 7 features a one inch stroke, while the Mark 9 has a 5/8 inch stroke. Both reduce trigger cycles required to install cable ties.
- Ergonomic design on both tools ideally fit the operator's hand. Removable padded hand grips further reduce impact to the hand.
- Low friction bearing mechanisms reduce hand effort and provide a smooth stroke.
- Extremely light, the Mark 7 weighs only 10 ounces. The Mark 9 weighs just 13 ounces.
- Quick tension adjustability for flush cut-off.



MK7

Mark 7 Tool

Product Selection					
Article No.	Part No.	Type	Description	Cable Tie Series	Pkg. Qty.
110-07500	MK7	MK7	Durable and lightweight, the Mark 7 tool is user friendly and adjustable, with top-of-the-line design features.	T18 thru T50 Series CTT20 thru CTT60 Series	1
110-07000	MK7HT	MK7HT	The Mark 7 High Tension tool has the same design features as the MK7, although this tool offers an increased tension range.	T30 thru T50 Series CTT20 thru CTT60 Series	1
110-08000	MK7LK	MK7LK	The Mark 7 Lock-Out tool has the same design features as the MK7, although this tool offers complete lock-out of tension settings.	T30 thru T50 Series CTT20 thru CTT60 Series	1
110-00448	MK7BLADEKIT	MK7BLADEKIT	Service kit for MK7 tool includes replacement blade, screw for nose piece, and instruction card.		1
110-00449	MK7-449	MK7-449	Replacement blade for MK7 series tools.		1

Dimensions are approximate and subject to technical changes. Use **Part No.** for ordering and **Type** for specification purposes. Minimum order quantity for the MK7-449 is 5.

Mechanical Cable Tie Tools

Mark 9 Tool



MK9



MK9SST

Product Selection					
Article No.	Part No.	Type	Description	Cable Tie Series	Pkg. Qty.
110-09500	MK9	MK9	The Mark 9 tool has the same design features as the MK7 series tools. The MK9 accommodates heavy duty cable ties.	T18* thru T250 Series CTT20 thru CTT175 Series EL-TY Series Wide Strap Series	1
110-09000	MK9HT	MK9HT	The Mark 9 High Tension tool has the same design features as the MK9, but offers an increased tension range.	T18* thru T250 Series CTT20 thru CTT175 Series EL-TY Series Wide Strap Series	1
110-09700	MK9RE	MK9RE	The MK9 Rounded Edge tool has the same design features as the MK9 although it has a special nose piece that leaves a 2mm round tail.	T18* thru T250 Series CTT20 thru CTT175 Series EL-TY Series Wide Strap Series	1
110-09600	MK9REF	MK9REF	The Mark 9 Reduced Effort tool has a reduced effort trigger mechanism for operators with small hands. It has a shorter pawl stroke.	T18* thru T250 Series CTT20 thru CTT175 Series EL-TY Series Wide Strap Series	1
110-95000	MK9SST	MK9SST	Adapted for use with stainless steel ties, the MK9 Stainless Steel tool retains the same design features as the MK9 series. The MK9SST accommodates all HellermannTyton stainless steel ties.	All MBT Series for both 304 and 316 materials	1
110-00220	MK9BLADEKIT	MK9BLADEKIT	Service kit for the MK9 tool includes replacement blade, screw for nose piece, and instruction card.		1
110-00221	MK9-221	MK9-221	Replacement blade for MK9 series		1
110-05114	MK9SS-114	MK9SS-114	Replacement blade for MK9SST series tools		1

Dimensions are approximate and subject to technical changes. Use **Part No.** for ordering and **Type** for specification purposes. * Does not include T18S series ties .08" wide.

Other Mechanical Cable Tie Tools

Product Selection					
Article No.	Part No.	Type	Description	Cable Tie Series	Pkg. Qty.
110-21000	TWT1	TWT	The TytonTwyster is a lightweight and economical twist tool. Offers speed and efficiency. Fits into a pocket. (Color Orange)	T18 thru T50 Series CTT20 thru CTT60 Series	1
110-22000	TWT2	TWT	The TytonTwyster is a lightweight and economical twist tool. Offers speed and efficiency. Fits into a pocket. (Color Blue)	T120 thru T150 Series CTT175 Series	1
110-11150	T150	T150	The T150 Tool is a heavy duty installer controlled tool for use in the field. Pliers action provides mechanical advantage. Padded foam grip handles provide comfort and control.	T150 Series CTT175 Series	1
110-11250	T250	T250	The T250 has the same design features as the T150 Tool, but can tension and cutoff a wider tie.	T150 thru T250 Series CTT175 Series	1

Dimensions are approximate and subject to technical changes. Use **Part No.** for ordering and **Type** for specification purposes.

SwiftMark Automatic Label Printer and Applicator

HellermannTyton's SwiftMark prints and applies labels automatically to wire and cable. With the largest wire range in the industry, the SwiftMark has uncompromising application speed and easily meets standards for application in relation to the end of the wire.

Features

- Fast cycle time
- Print on demand (label printed is the label applied)
- Reprint on demand (reprint labels for sequences or other critical applications)
- Ribbon save feature - less waste
- Faster text changes
- Allows variability in printed text
- High reliability
- Marks to within .5" of the end of a cable or connector
- Accommodates pre-terminated wire and cable, and can even wrap cable bundles and twisted cables
- Touch screen LCD
- Ribbon save feature
- Adjustable wire grippers to secure the wire as close as possible to the label
- Print "repeat" button to repeat any missing labels when printing sequences and random data
- 300 d.p.i. printhead
- Uses self-laminating adhesive labels printed using an internal thermal transfer ribbon
- Foot pedal, touch screen, and 24V wrap initiation options

SwiftMark Includes

- 1 SwiftMark
- 1 Foot pedal
- 1 External power supply
- 1 Manual
- 1 Tagprint Pro V2.0 label printing software.
- 1 Driver disk



Specifications	
Width	20"
Height	15"
Depth	31"
Weight	60 lbs.
Wire Range	.060" - .75"
Label Widths	.5" - 2"
Power	Electric universal power supply
Storage Temperature	-30 °F to +160 °F (-34 °C to +71 °C)
Connections	USB, RS-232, Serial, Parallel, SD/MMC secure digital card interface, Ethernet

Product Selection				
Article No.	Part No.	Type	Description	Pkg. Qty.
558-00060	556-00022	SMLA1	SwiftMark Automatic Label Printer and Applicator	1

Contact HellermannTyton for details and label information. Use **Part No.** for ordering and **Type** for specification purposes.

TagPrint™ Pro Professional Label Creation Software

TagPrint™ Pro label creation and printing software is powerful, multi-functional and extremely easy to use. Used to provide solutions for industrial identification, TagPrint™ Pro speeds production and offers many options for a wide variety of labeling requirements. "What You See Is What You Get" (WYSIWYG) label creation, bar coding, serialization, label sets, wire lists, graphics and text choices are just some capabilities of TagPrint™ Pro software. TagPrint™ Pro can be utilized with HellermannTyton's wide array of label options including laser, ink jet, dot matrix and thermal transfer printable labels.

New Features for Version 2.0

- Alphanumeric sequences
- Print to multiple printers at one time
- Print later feature allows user to save jobs in queue and print all at one time
- Print faster
- Connect or import directly from other databases including Excel, Access, text files
- More bar code types
- Inverse, flip, and mirror image options for graphic images
- Multi-lingual
- Print log available
- Manually adjust font size to 1/10 of a point
- Customize height and width of characters
- Customize line spacing
- Compatible with all TagPrint Pro version 1.0 files
- And much more!

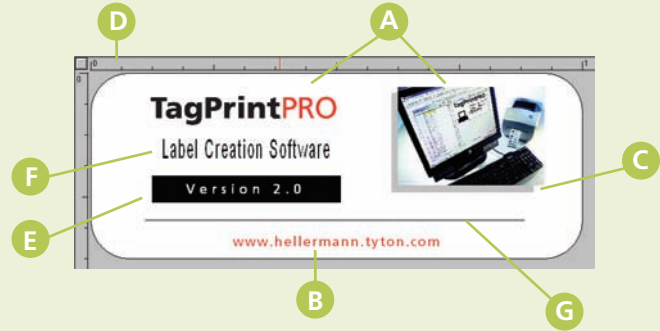

- A** Easily import a variety of image types into the label design
- B** Use any Windows based font in the label design for complete customization
- C** Layer objects like professional page layout programs
- D** Rulers on top and side allow for exact placement of objects
- E** Easily change text color, fill color and border color to make text stand out and accomplish "full reverse" printing
- F** Allow text characters to be stretched or compressed to almost any height or width
- G** Draw lines, circles and boxes on the label as a simple way of making the label look more professional

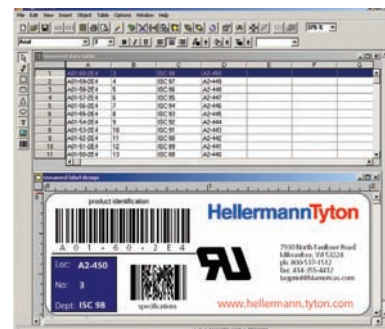

Product Selection				
Article No.	Part No.	Type	System Requirements	Pkg. Qty.
556-00022	556-00022	TAGPRINTPRO Version 2.0 - Full	Windows 98se, ME, NT4.0, 2000 or XP	1
556-00024	556-00024*	TAGPRINTPRO Version 2.0 - Upgrade	Windows 98se, ME, NT4.0, 2000 or XP	1

*Existing owners of previous versions of TagPrint can qualify for an upgrade at a reduced cost with proof of purchase and a valid serial number. Contact HellermannTyton for details. Use **Part No.** for ordering and **Type** for specification purposes.

Spirit® 2100 Portable Printing System



The Spirit 2100 provides fast, high quality, thermal transfer printing for permanent and highly legible label printing. The Spirit 2100 prints on many different types of label materials for wire, cable, and component marking. Self-laminating, white and metalized polyester, and tamper evident materials for calibration and security labeling are available for use with the Spirit system.

Product Features

- "What You See Is What You Get" label design and creation.
- Choose from normal or bold fonts to complete the label design
- Easily change text sizes: tiny, normal or large text
- And much more! Contact HellermannTyton for more details

Product Selection				
Article No.	Part No.	Type	Description	Pkg. Qty.
557-00085	HT2100	HT2100	Portable Printing System includes: Spirit 2100 printer, HT2100 rechargeable battery and charger, ribbon cartridge, TAGH73-336, printer manual, CD-Rom tutorial, hard shell case, cleaning card, cleaning pen and Spiritlink computer interface software (interface software cable sold separately)	1

Use **Part No.** for ordering and **Type** for specification purposes.

Spirit 2100 Accessories

Product Selection				
Article No.	Part No.	Type	Description	Pkg. Qty.
591-00076	BC10	BC10	Battery Charger	1
557-00002	2100CASE	2100CASE	Spirit Carrying Case	1
557-00004	2100CABLE	2100CABLE	SpiritLink interface cable.	1
557-00003	RBP1	RBP1	Battery Pack	1
557-00005	2100PEN	2100PEN	Cleaning Pen	1
557-00006	TS3003039	TS3003039	Spirit label Spindle Roll	1
557-00007	TS3003040	TS3003040	Spirit label Spindle cap	1
557-00008	2100CARD	2100CARD	Printhead cleaning card	1
591-00003	2100AC	2100AC	AC Adaptor	1

Use **Part No.** for ordering and **Type** for specification purposes.

Ribbon

The ribbon is supplied in a self-contained cartridge for easy loading. *One ribbon per package.*

Product Selection								
Article No.	Part No.	Type	Description	Width (W)		Height (H)		Pkg. Qty.
				In.	(mm)	In.	(mm)	
557-00009*	HHIGR	HHIGR	Replacement ribbon cartridge	2.0	(50.8)	2.50	(63.5)	131 ft (40 m)
557-00092	HHHST	HHHST	Ribbon cartridge	2.0	(50.8)	2.50	(63.5)	131 ft (40 m)
557-00075**	HHDTH	HHDTH	Replacement Durattach ribbon	2.0	(50.8)	2.50	(63.5)	131 ft (40 m)

Dimensions are approximate and subject to technical changes. Use **Part No.** for ordering and **Type** for specification purposes.

* HHIGR works on all materials

** HHDTHT can only be used with label materials that have the DTH extension. This provides superior performance to most chemicals and solvents.

TT320SM Printer

The HellermannTyton TT320SM printer is a thermal transfer printing system designed for medium to low volume users of HellermannTyton thermal transfer labels and ShrinkTrak.



Product Features

- 300 dots per inch thermal transfer printer
- Print speed of 1" to 2" per second. (print speeds of up to 4" per second are possible when using the TT320SM printer with HellermannTyton's new Tagprint V2.0 label printing software)
- Prints label lengths up to 11" & 10" with standard memory
- 512K SRAM / 1 MB Flash RAM standard - Upgradable to 1MB SRAM
- Easy-to-load label and ribbon path
- Sturdy metal enclosure
- Internal rewriter standard
- Printer is not supplied with ribbons. Order ribbons separately.
- HellermannTyton labels must be fed through a slot in rear panel of printer from CADDY5.0

Product Selection				
Article No.	Part No.	Type	Description	Pkg. Qty.
556-00320	TT320SM	TT320SM	TT320SM Printer	1
556-03022	CADDY5.0	Label Caddy 5.0	Label Caddy	1
556-03018	105910-155	Printhead TT320SM	Printhead	1

Use **Part No.** for ordering and **Type** for specification purposes.

TT320SM Thermal Transfer Ribbons

Due to various settings in printers, the different label types and variations in ribbons, each material must have its own specific ribbon. For instance, when ordering HellermannTyton 822 material labels, please specify and use the ribbon that is configured for the 822 stock. In this case, it would be the TT822 ribbon. In addition, this ribbon must be used to have the Underwriters Laboratories recognized mark on the 822 material.*

Product Selection															
Article No.	Part No.	Type	Color	Label Material									Width (W)		Length (L)
				Paper	100	250	795	822	822C	900	DTH	ShrinkTrak	In. (mm)	Ft. (M)	
556-00145	TT822OUTSM	TT822	Black	•		•	• (1,2)	•	•				• (4)	4.33 (110)	242 (74)
556-00146*	TT822OUTSM10	TT822	White					• (1,2)	• (1,2)				•	4.33 (110)	242 (74)
556-00147**	TT822OUTSM2	TT822	Red	•	•	•	•							4.33 (110)	242 (74)
556-00148**	TT822OUTSM3	TT822	Orange	•	•	•	•	•	•					4.33 (110)	242 (74)
556-00149**	TT822OUTSM4	TT822	Yellow	•	•	•	•	•	•					4.33 (110)	242 (74)
556-00150**	TT822OUTSM5	TT822	Green	•	•	•	•	•	•					4.33 (110)	242 (74)
556-00151**	TT822OUTSM6	TT822	Blue	•	•	•	•	•	•					4.33 (110)	242 (74)
556-00152**	TT822OUTSM7	TT822	Purple	•	•	•	•	•	•					4.33 (110)	242 (74)
556-00153* **	TT822OUTSM8	TT822	Silver Gray										•	4.33 (110)	242 (74)
556-00163	TTHSTOUTSM	TTHST	Black		°	°							• (4)	4.33 (110)	242 (74)
556-00143	TTDTHOUTSM	TTDTH	Black									• (5)	• (5)	4.33 (110)	242 (74)

Use **Part No.** for ordering and **Type** for specification purposes.

• =Recommended ribbon

° =Acceptable ribbon alternative

(1) UL Recognized material / ribbon combination with HellermannTyton thermal transfer printers

(2) CSA Normal Use approved material / ribbon combination with HellermannTyton thermal transfer printers

(3) CSA Heavy Duty Use approved material / ribbon combination with HellermannTyton thermal transfer printers

(4) Meets ASM-DTL-23053/5 Class I & III, SAE-AS81531 for print performance





(5) Outstanding chemical, abrasion and solvent resistance where UL and CSA requirements are not needed

* Call HellermannTyton for assistance when using this ribbon.

** 10 ribbon minimum order

Wire Diameter Guide to HellermannTyton Labels

This guide can be used to determine which labels will work best with the wire diameter selected. Simply place the end of the wire over the appropriate circle to select the best label size.

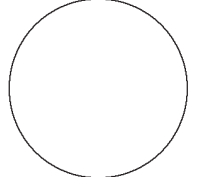
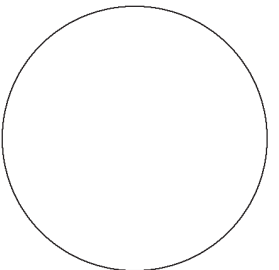
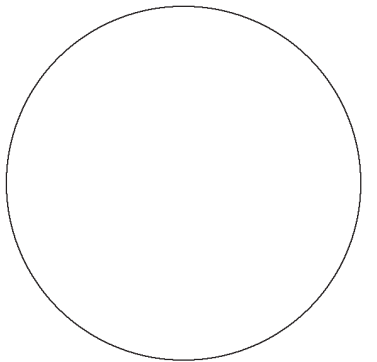
If your wire or cable diameter is less than or equal to below, use:	Spirit 2100 Labels	Thermal Transfer Labels	ShrinkTrak Markers	Laser Labels	Ink Jet Labels	Dot Matrix Labels
.10" 	TAGH26-100 TAGH51-100	TAG26T6-100B TAG21T6-250 TAG51T3-100B	553-50001 to 553-50014 553-50063 553-50067 to 553-50081	TAG26L-105	TAG26L-994 TAG51J-994	TAG26-100
.20" 	TAGH22-100 TAGH2-100	TAG2T5-100B TAG22T3-100B TAG51T3-100B	553-50015 to 553-50022 553-50065	TAG63L-105 TAG49L-105 TAG51L-105	TAG5J-994 TAG22J-994	TAG2-100 TAG5-100 TAG22-100
.28" 	TAGH2-100 TAGH22-100 TAGH24-100 TAGH25-100	TAG2T5-100B TAG22T3-100B TAG28T4-250 TAG24T1-100B TAG53T2-100B	553-50023 to 553-50027	TAG2L-105 TAG5L-105 TAG63L-105 TAG52L-105	TAG22J-994	TAG2-100 TAG5-100 TAG22-100 TAG24-100 TAG25-100
.54" 	TAGH9-100 TAGH10-100	TAG9T3-100B TAG1T1-100B TAG10T2-100B	553-50028 to 553-50037	TAG9L-105 TAG1L-105 TAG10L-105 TAG65L-105	TAG9J-994	TAG9-100 TAG10-100
.94" 	TAGH3-100 TAGH6-100 TAGH95-100	TAG3T3-100B TAG6T1-100B	553-50038 to 553-50042	TAG50L-105 TAG64L-105	TAG64J-994	TAG3-100 TAG6-100
1.40" 	TAGH4-100	TAG7T1-100B				TAG4-100 TAG8-100
1.90" 		TAG7T1-100B TAG38T4-100B				TAG7-100 TAG8-100 TAG23-100 TAG38-100

TipTags Cable Markers

HellermannTyton's TipTags are non-adhesive, cross laminated polyolefin tags with die cut cable tie slots for mechanical fastening. These cable markers are designed to mark wire bundles or large cables. TipTags are ideal for applications where exceptional print performance and long term service life are critical. TipTags consist of a thin, strong material which allows the tags to be lightweight, very strong, tear resistant, and work well in thermal transfer printers.



- Thermal transfer printable for high print contrast
- Halogen free for low smoke and low fire hazard applications
- White front and yellow back for versatility
- Superior strength and tear resistance for long lasting identification
- Pre-cut slots to secure the TipTag using HellermannTyton cable ties
- Printable on both sides
- Printable with Durattach ribbon on white side for the most durable mark in the industry
- Pre-cut sensor slot which ensures the markers will work in any thermal transfer printer
- Perforated in a bandolier for easy knitting and access to individual markers
- Thin profile to take up less space and eliminate any chance of the marker damaging wire insulation
- Lightweight design for applications that require long-term fuel and weight considerations

Material:	Polyolefin cross laminated with clear polyester laminate Polyolefin base: 6.5 mil Clear polyester laminate: 1.0 mil
Properties:	Halogen-free (low smoke and low fire hazard) Superior print performance, especially with Durattach ribbons Unaffected by most chemicals Wide service temperature range Non-toxic, odorless, and can be recycled or incinerated
Service Temperature Range:	-58°F to +221°F (-50°F to +105°C) Can withstand spikes up to 135°C (275°F) for short periods of time
Approvals:	SAE-AS81531 and Mil-Std 202G, Method 215J



TipTags Cable Markers *continued*

Material Data	
Material	Polyolefin, cross laminated
Operating Temperature	-58 °F to +221 °F (-50 °C to +105 °C) continuous
Certification	Meets SAE-AS81531, Mil-Std 202G Method 215J, and BS 4G 198-3, Type 11a



Product Selection							
Article No.	Part No.	Type	Marker Size		Printable Area		Pkg. Qty.
			in.	(mm)	in.	(mm)	
556-26008	556-26008	TIPTAGVA15X65YEW	2.59" X .68"	(65 X 17.4)	2.58" X .59"	(65 X 15)	500
556-26006	556-26006	TIPTAGVA10X65YEW	2.59" X .50"	(65 X 12.7)	2.58" X .39"	(65 X 10)	500
556-26007	556-26007	TIPTAGVA10X90YEW	3.54" X .50"	(90 X 12.7)	3.54" X .40"	(90 X 10)	500
556-26009	556-26009	TIPTAGVA15X90YEW	3.54" X .68"	(90 X 17.4)	3.54" X .59"	(90 X 15)	500

Dimensions are approximate and subject to technical changes. Use **Part No.** for ordering and **Type** for specification purposes.

T18 - T30 Series Cable Ties - Natural and Black

Material Data	
Material	Polyamide 6.6 (PA66)
Operating Temperature	-40 °F to +185 °F (-40 °C to +85 °C) continuous



File# E64139

File# E64139

Product Selection													
Article No.	Part No.	Type	US Gov. Designation	Min. Tensile Strength		Length (L)		Max. Ø Bundle		Width (W)	Color	Pkg. Qty.	
				lbs.	(N)	in.	(mm)	in.	(mm)				in.
111-02809	T18S9M4	T18S	MS3367-4-9	18 lbs	(80)	3.27"	(83)	.63"	(16)	.09"	(2.3)	Natural	1000
111-02811	T18S0M4	T18S	*	18 lbs	(80)	3.27"	(83)	.63"	(16)	.09"	(2.3)	Black	1000
111-01872	T18R9M4	T18R	MS3367-4-9	18 lbs	(80)	4"	(100)	.87"	(22)	.10"	(2.5)	Natural	1000
111-01841	T18R0M4	T18R	*	18 lbs	(80)	4"	(100)	.87"	(22)	.10"	(2.5)	Black	1000
111-02322	T18I9M4	T18I	-	18 lbs	(80)	5.51"	(140)	1.38"	(35)	.10"	(2.5)	Natural	1000
111-02315	T18I0M4	T18I	-	18 lbs	(80)	5.51"	(140)	1.38"	(35)	.10"	(2.5)	Black	1000
111-02026	T18L9M4	T18L	-	18 lbs	(80)	8.0"	(205)	2.17"	(55)	.10"	(2.5)	Natural	1000
111-02015	T18L0M4	T18L	-	18 lbs	(80)	8.0"	(205)	2.17"	(55)	.10"	(2.5)	Black	1000
111-03047	T30R9M4	T30R	MS3367-5-9	30 lbs	(135)	5.9"	(150)	1.38"	(35)	.14"	(3.5)	Natural	1000
111-03034	T30R0M4	T30R	*	30 lbs	(135)	5.9"	(150)	1.38"	(35)	.14"	(3.5)	Black	1000
111-03327	T30L9M4	T30L	-	30 lbs	(135)	7.48"	(190)	1.97"	(50)	.14"	(3.5)	Natural	1000
111-03315	T30L0M4	T30L	-	30 lbs	(135)	7.48"	(190)	1.97"	(50)	.14"	(3.5)	Black	1000
111-03517	T30LL9M4	T30LL	-	30 lbs	(135)	11.42"	(290)	3.15"	(80)	.14"	(3.5)	Natural	1000
111-03511	T30LL0M4	T30LL	-	30 lbs	(135)	11.42"	(290)	3.15"	(80)	.14"	(3.5)	Black	1000
111-02907	T30XL9M4	T30XL	MS3367-5-9	30 lbs	(135)	14.37"	(365)	4.13"	(105)	.14"	(3.5)	Natural	1000
111-02903	T30XL0M4	T30XL	*	30 lbs	(135)	14.37"	(365)	4.13"	(105)	.14"	(3.5)	Black	1000

Dimensions are approximate and subject to technical changes. Use **Part No.** for ordering and **Type** for specification purposes.

* Military black available. Contact HellermannTyton for more information.

ShrinkTrak™ Heat Shrinkable Markers

HellermannTyton's ShrinkTrak™ heat shrinkable markers make it easy to mark wire, cable, and other components. These ladder-style markers are designed with side slits for easier application. All ShrinkTrak™ markers are military specified. They also reduce printer jams with their efficient and high performance design. For seamless labeling, ShrinkTrak™ can be printed using HellermannTyton's TagPrint™ Pro professional label creation software, thermal transfer printers and ribbons to create a permanent and solvent resistant print when shrunk and applied.

Versatile

- Flexible, flame retardant, heat shrinkable polyolefin tubing meets all military specifications
- 3:1 shrink ratio
- Standard colors - yellow, white and black
- Larger packaging options result in less box changes

High Performance Design

- Center slit versions reduce or eliminate hand cutting
- Non-slip, printable liner allows additional marker data to be printed on the reverse side for records and placement instructions
- Utilize HellermannTyton's Durattach ribbon system for the highest print performance on the market

Reduce Printer Jams

- Markers dispense directly into HellermannTyton thermal transfer printers with custom box opening
- Dispense markers faster and easier with waxed core dispenser

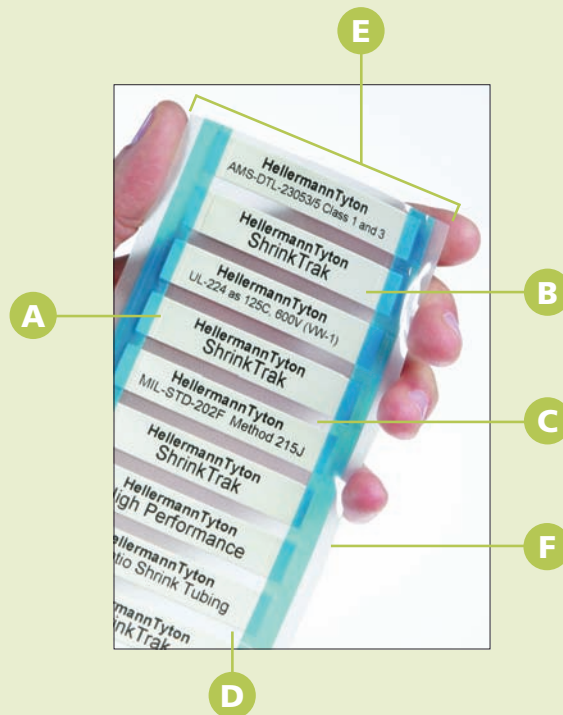

- A. Side slit for easy insertion and removal from liner
- B. Smooth, flat surface allows for consistent printing
- C. Reduced spacing between markers for more efficient use of ribbon material
- D. Markers firmly secured on anti-static liner to reduce static build-up in printers
- E. Standard width to fit almost all thermal transfer printers
- F. Pin-feed system not required

Ease of Use - Step by Step Guide



Step 1
Print with thermal transfer printer



Step 2
Bend liner at side slit



Step 3
Insert wire into marker



Step 4
Pull-up on wire - the marker will pull away from liner



ShrinkTrak Applied!

ShrinkTrak™ Heat Shrinkable Markers *continued*

Material Data	
Material	Polyolefin, cross-linked (POX)
Product Thickness	3 mil total thickness
Shrink Temperature (nominal)	+194 °F (+90 °C)
Operating Temperature	-67 °F to +275 °F (-55 °C to +135 °C)
Flame Retardant	Yes
Flammability	UL224 VW1
Flexibility	flexible
Abrasion Resistance	Good
Solvent Resistance	Good
Standard Colors	White, Yellow & Black
*For other colors, contact HellermannTyton	
UL Rating	Meets UL-224 as +257 °F (+125 °C), 600V (VW-1)
Certification	AMS-DTL-23053/5 Class 1 and 3, SAE-AS81531, MIL-STD-202G Method 215K



Recommended Thermal Transfer Ribbons

TT320SM Printer

TTDTHOUTSM
T822OUTSM
TTHSTOUTSM
TT900OUTSM

TT1210 or other thermal transfer printer

TTDTHOUT
TT822OUT
TTHSTOUT
TT900OUT



ShrinkTrak Specifications

Diameter Size	0.125"	0.187"	0.25"	0.375"	0.50"	0.75"	1.0"
Wire Size Range (AWG/MCM)	18-22 (.044 - 1)	12-18 (.063 - .17)	10-16 (.083 - .230)	8-14 (.122 - .340)	2-10 (.166 - .470)	6-0000 (.25 - .725)	1-400 (.330 - .876)
Inside Diameter as Supplied In. (mm)*	0.118 +/- 0.024 (3.0 +/- 0.6)	0.177 +/- 0.032 (4.5 +/- 0.8)	0.236 +/- 0.040 (6.0 +/- 1.0)	0.354 +/- 0.040 (9.0 +/- 1.0)	0.470 +/- 0.024 (12.0 +/- 1.0)	0.732 +/- 0.040 (18.6 +/- 1.0)	1.024 +/- 0.040 (26.0 +/- 1.0)
Inside Diameter After Recovery In. (mm)	0.043 (1.0)	0.063 (1.6)	0.083 (2.1)	0.122 (3.1)	0.166 (4.2)	0.25 (6.35)	0.33 (8.3)
Wall Thickness After Recovery In. (mm)	0.0209 +/- 0.040 (.53 +/- 0.10)	0.026 +/- 0.004 (.65 +/- 0.10)	0.028 +/- 0.004 (.71 +/- 0.10)	0.031 +/- 0.006 (0.78 +/- 0.15)	0.033 +/- 0.006 (0.83 +/- 0.15)	0.036 +/- 0.006 (0.91 +/- 0.15)	0.039 +/- 0.006 (.99 +/- 1.6)
Overall Width In. (mm)	0.209 +/- 0.040 (5.3 +/- 1.0)	0.303 +/- 0.052 (7.7 +/- 1.3)	0.398 +/- 0.063 (10.1 +/- 1.6)	0.587 +/- 0.063 (14.9 +/- 1.6)	0.776 +/- 0.063 (19.7 +/- 1.6)	1.21 +/- 0.063 (30.8 +/- 1.6)	1.63 +/- 0.063 (41.38 +/- 1.6)
Overall Height In. (mm)	0.020 (0.508)	0.020 (0.508)	0.020 (0.508)	0.022 (0.558)	0.023 (0.582)	0.025 (0.63)	0.03 (0.76)
Dimensional Reference (if the wire or cable diameter is less than or equal to)							



*As supplied



**Recovered

* Contact HellermannTyton for custom color options.

** Meets printer performance requirements of SAE-AS81531 using the ribbons listed above in any thermal transfer printer, including HellermannTyton's TT320SM and TT1210

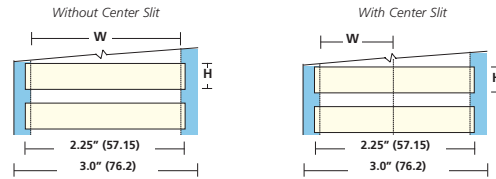
ShrinkTrak™ Heat Shrinkable Markers *continued*

Product Selection								Width (W)	Height (H)	Pkg. Qty.
Article No.	Part No.	Type	Cross Ref to Former Part No.	Color	Center Slit	In. (mm.)	In. (mm.)			
0.125" (3.17mm) - Outside Diameter										
553-50001	553-50001	HST3-1BK	THS-610BM	Black	-	1.9" (48.26)	.235" (5.97)	250		
553-50002	553-50002	HST3-1WH	THS-610W	White	-	1.9" (48.26)	.235" (5.97)	250		
553-50003	553-50003	HST3-1WH	THS-610W10C	White	-	1.9" (48.26)	.235" (5.97)	1000		
553-50078	553-50078	HST3-1WH	THS-610W25C	White	-	1.9" (48.26)	.235" (5.97)	2500		
553-50004	553-50004	HST3-1WH-S	THS-610WP	White	Single	.95" (24.1)	.235" (5.97)	500		
553-50074	553-50074	HST3-1WH-S	THS-610WP10C	White	Single	.95" (24.1)	.235" (5.97)	2000		
553-50067	553-50067	HST3-1WH-S	THS-610WP25C	White	Single	.95" (24.1)	.235" (5.97)	5000		
553-50070	553-50070	HST3-1WH-2S	THS-610W2P	White	Double	.63" (16.08)	.235" (5.97)	750		
553-50075	553-50075	HST3-1WH-2S	THS-610W2P10C	White	Double	.63" (16.08)	.235" (5.97)	3000		
553-50063	553-50063	HST3-1WH-3S	THS-610W3P	White	Triple	.475" (12.07)	.235" (5.97)	1000		
553-50088	553-50088	HST-32WH3S10C	THS-610W3P10C	White	Triple	.475" (12.07)	.235" (5.97)	4000		
553-50006	553-50006	HST3-1YE	THS-610Y10C	Yellow	-	1.9" (48.26)	.235" (5.97)	1000		
553-50005	553-50005	HST3-1YE	THS-610Y	Yellow	-	1.9" (48.26)	.235" (5.97)	250		
553-50007	553-50007	HST3-1YE-S	THS-610YP	Yellow	Single	.95" (24.1)	.235" (5.97)	500		
553-50076	553-50076	HST3-1YE-S	THS-610YP10C	Yellow	Single	.95" (24.1)	.235" (5.97)	2000		
553-50071	553-50071	HST3-1WH-2S	THS-610Y2P	Yellow	Double	.63" (16.08)	.235" (5.97)	750		
553-50077	553-50077	HST3-1YE-2S	THS-610Y2P10C	Yellow	Double	.63" (16.08)	.235" (5.97)	3000		
0.187" (4.74 mm) - Outside Diameter										
553-50008	553-50008	HST4.8-16BK	THS-615BM	Black	-	1.9" (48.26)	.312" (7.92)	250		
553-50009	553-50009	HST4.8-16WH	THS-615W	White	-	1.9" (48.26)	.312" (7.92)	250		
553-50010	553-50010	HST4.8-16WH	THS-615W10C	White	-	1.9" (48.26)	.312" (7.92)	1000		
553-50177	553-50177	HST4.8-1WH	THS-615W30C	White	-	1.9" (48.26)	.312" (7.92)	3000		
553-50079	553-50079	HST4.8-1WH	THS-615W50C	White	-	1.9" (48.26)	.312" (7.92)	5000		
553-50011	553-50011	HST4.8-16WH-S	THS-615WP	White	Single	.95" (24.1)	.312" (7.92)	500		
553-50080	553-50080	HST4.8-1WH-2S	THS-615WP10C	White	Single	.95" (24.1)	.312" (7.92)	2000		
553-50068	553-50068	HST4.8-1WH-2S	THS-615W2P	White	Double	.633" (16.08)	.312" (7.92)	750		
553-50072	553-50072	HST4.8-1WH-2S	THS-615W2P10C	White	Double	.633" (16.08)	.312" (7.92)	3000		
553-50064	553-50064	HST4.8-1WH-3S	THS-615W3P	White	Triple	.475" (12.07)	.312" (7.92)	1000		
553-50081	553-50081	HST4.8-1WH-3S	THS-615W3P10C	White	Triple	.475" (12.07)	.312" (7.92)	4000		
553-50013	553-50013	HST4.8-1.6YE	THS-615Y10C	Yellow	-	1.9" (48.26)	.312" (7.92)	1000		
553-50012	553-50012	HST4.8-1.6YE	THS-615Y	Yellow	-	1.9" (48.26)	.312" (7.92)	250		
553-50014	553-50014	HST4.8-1.6YE-S	THS-615WP	Yellow	Single	.95" (24.1)	.312" (7.92)	500		
553-50069	553-50069	HST4.8-1YE-2S	THS-615Y2P	Yellow	Double	.633" (16.08)	.312" (7.92)	750		
553-50073	553-50073	HST4.8-1YE-2S	THS-615Y2P10C	Yellow	Double	.633" (16.08)	.312" (7.92)	3000		

Dimensions are approximate and subject to technical changes. Use **Part No.** for ordering and **Type** for specification purposes.

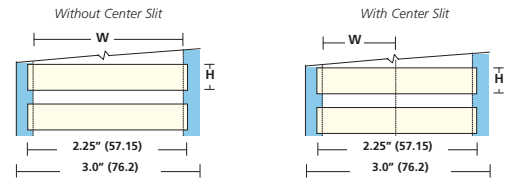
ShrinkTrak™ Heat Shrinkable Markers *continued*

Product Selection								
Article No.	Part No.	Type	Cross Ref to Former Part No.	Color	Center Slit	Width (W)	Height (H)	Pkg. Qty.
						In. (mm.)	In. (mm.)	
0.25" (6.35mm) - Outside Diameter								
553-50015	553-50015	HST6-2BK	THS-620BM	Black	-	1.9" (48.26)	.420" (10.67)	250
553-50016	553-50016	HST6-2WH	THS-620W	White	-	1.9" (48.26)	.420" (10.67)	250
553-50017	553-50017	HST6-2WH	THS-620W10C	White	-	1.9" (48.26)	.420" (10.67)	1000
553-50018	553-50018	HST6-2WH	THS-620W50C	White	-	1.9" (48.26)	.420" (10.67)	5000
553-50019	553-50019	HST6-2WH-S	THS-620WP	White	Single	.95" (24.1)	.420" (10.67)	500
553-50084	553-50084	HST6-2WH-S	THS-620WP10C	White	Single	.95" (24.1)	.420" (10.67)	2000
553-50082	553-50082	HST6-2WH-2S	THS-620W2P	White	Double	.633" (16.08)	.420" (10.67)	750
553-50065	553-50065	HST6-2WH-3S	THS-620W3P	White	Triple	.475" (12.07)	.420" (10.67)	1000
553-50089	553-50089	HST6-2WH-3S	THS-620W3P10C	White	Triple	.475" (12.07)	.420" (10.67)	4000
553-50020	553-50020	HST6-2YE	THS-620Y	Yellow	-	1.9" (48.26)	.420" (10.67)	250
553-50021	553-50021	HST6-2YE	THS-620Y10C	Yellow	-	1.9" (48.26)	.420" (10.67)	1000
553-50022	553-50022	HST6-2YE-S	THS-620YP	Yellow	Single	.95" (24.1)	.420" (10.67)	500
553-50085	553-50085	HST6-2YE-S	THS-620YP10C	Yellow	Single	.95" (24.1)	.420" (10.67)	2000
553-50083	553-50083	HST6-2YE-2S	THS-620Y2P	Yellow	Double	.633" (16.08)	.420" (10.67)	750
0.375" (9.52 mm) - Outside Diameter								
553-50023	553-50023	HST9-3BK	THS-625BM	Black	-	1.9" (48.26)	.597" (15.16)	250
553-50024	553-50024	HST9-3WH	THS-625W	White	-	1.9" (48.26)	.597" (15.16)	250
553-50025	553-50025	HST9-3WH-S	THS-625WP	White	Single	.95" (24.1)	.597" (15.16)	500
553-50066	553-50066	HST9-3WH-3S	THS-625W3P	White	Triple	.475" (12.07)	.597" (15.16)	1000
553-50026	553-50026	HST9-3YE	THS-625Y	Yellow	-	1.9" (48.26)	.597" (15.16)	250
553-50027	553-50027	HST9-3YE-S	THS-625YP	Yellow	Single	.95" (24.1)	.597" (15.16)	500
0.50" (12.7 mm) - Outside Diameter								
553-50028	553-50028	HST12-4BK	THS-630BM	Black	-	1.9" (48.26)	.77" (19.55)	250
553-50029	553-50029	HST12-4WH	THS-630W	White	-	1.9" (48.26)	.77" (19.55)	250
553-50030	553-50030	HST12-4WH-S	THS-630WP	White	Single	.95" (24.1)	.77" (19.55)	500
553-50086	553-50086	HST12-4WH-3S	THS-630W3P	White	Triple	.475" (12.07)	.77" (19.55)	1000
553-50031	553-50031	HST12-4YE	THS-630Y	Yellow	-	1.9" (48.26)	.77" (19.55)	250
553-50032	553-50032	HST12-4YE-S	THS-630YP	Yellow	Single	.95" (24.1)	.77" (19.55)	500
553-50087	553-50087	HST12-4YE-3S	THS-630Y3P	Yellow	Triple	.475" (12.07)	.77" (19.55)	1000
0.75" (19.05 mm) - Outside Diameter								
553-50033	553-50033	HST18-6BK	THS-635BM	Black	-	1.9" (48.26)	1.2" (30.48)	250
553-50034	553-50034	HST18-6WH	THS-635W	White	-	1.9" (48.26)	1.2" (30.48)	250
553-50035	553-50035	HST18-6WH-S	THS-635WP	White	Single	.95" (24.1)	1.2" (30.48)	500
553-50036	553-50036	HST18-6YE	THS-635Y	Yellow	-	1.9" (48.26)	1.2" (30.48)	250
553-50037	553-50037	HST18-6YE-S	THS-635YP	Yellow	Single	.95" (24.1)	1.2" (30.48)	500
1.0" (25.4mm) - Outside Diameter								
553-50038	553-50038	HST24-8BK	THS-640BM	Black	-	1.9" (48.26)	1.69" (42.93)	250
553-50039	553-50039	HST24-8WH	THS-640W	White	-	1.9" (48.26)	1.69" (42.93)	250
553-50040	553-50040	HST24-8WH-S	THS-640WP	White	Single	.95" (24.1)	1.69" (42.93)	500
553-50041	553-50041	HST24-8YE	THS-640Y	Yellow	-	1.9" (48.26)	1.69" (42.93)	250
553-50042	553-50042	HST24-8YE-S	THS-640YP	Yellow	Single	.95" (24.1)	1.69" (42.93)	500

Dimensions are approximate and subject to technical changes. Use **Part No.** for ordering and **Type** for specification purposes.

Thermal Transfer Self-Laminating Labels

HellermannTyton's self-laminating labels are used for marking wire and cable. The clear overlap protects printed information.

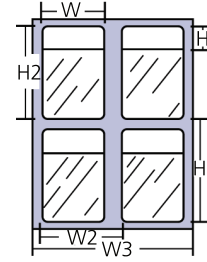

Product Selection											
Article No.	Part No.	Type	Drawing Reference	Width (W)	Height of Printable Area (H)	Height of Label (H2)	Vertical Repeat (H3)	Horizontal Repeat (W2)	Width of Liner (W3)	Labels per Row	Pkg. Qty.
			(page 35)	In. (mm)	In. (mm)	In. (mm)	In. (mm)	In. (mm)	In. (mm)		
100B Material											
596-00009	TAG26T6-100B	TAG26T6	A	.5" (12.7)	.375" (9.52)	.75" (19.05)	1.0" (25.4)	.5" (12.7)	3.35" (85.09)	6	10000
596-00010	TAG2T5-100B	TAG2T5	B	.5" (12.7)	.5" (12.7)	1.43" (36.5)	1.62" (41.28)	.66" (16.81)	3.35" (85.09)	5	10000
596-00014	TAG51T3-100B	TAG51T3	C	1.0" (25.4)	.35" (8.8)	.75" (19.05)	.937" (23.7)	1.075" (27.3)	3.35" (85.09)	3	10000
596-00006	TAG22T2-100B	TAG22T2	D	1.0" (25.4)	.5" (12.7)	1.43" (36.5)	1.62" (41.28)	1.075" (27.3)	2.25" (57.1)	2	5000
596-00007	TAG22T3-100B	TAG22T3	E	1.0" (25.4)	.5" (12.7)	1.43" (36.5)	1.62" (41.28)	1.075" (27.3)	3.35" (85.09)	3	5000
596-00027	TAG9T3-100B	TAG9T3	F	1.0" (25.4)	.75" (19.05)	2.25" (57.1)	2.5" (63.5)	1.0" (25.4)	3.35" (85.09)	3	5000
596-00013	TAG3T3-100B	TAG3T3	G	1.0" (25.4)	1.0" (25.4)	3.75" (95.25)	4.0" (101.6)	1.075" (27.3)	3.35" (85.09)	3	3000
596-00011	TAG38T4-100B*	TAG38T4	H	1.0" (25.4)	1.5" (38.1)	7.347" (188.89)	7.75" (196.80)	1.0" (25.4)	4.10" (104.14)	4	1000
596-00045	TAG53T2-100B	TAG53T2	I	3.35" (85.09)	.7" (17.78)	1.437" (36.49)	1.62" (41.28)	1.5" (38.1)	3.35" (85.09)	2	2500
596-00005	TAG1T1-100B	TAG1T1	J	1.9" (48.2)	.75" (19.05)	3.12" (79.2)	3.42" (86.8)	1.9" (48.2)	3.875" (98.42)	2	2500
596-00008	TAG24T1-100B	TAG24T1	K	2.0" (50.8)	.5" (12.7)	1.437" (36.49)	1.68" (42.6)	2.0" (50.8)	2.2" (55.9)	1	1000
596-00002	TAG10T2-100B	TAG10T2	L	2.0" (50.8)	.75" (19.05)	2.25" (57.1)	2.5" (63.5)	2.0" (50.8)	3.875" (98.42)	2	2500
596-00021	TAG7T1-100B*	TAG7T1	M	2.0" (50.8)	1.5" (38.1)	7.347" (188.89)	7.75" (196.80)	2.0" (50.8)	4.10" (104.14)	2	1000
596-00016	TAG6T1-100B	TAG6T1	N	2.0" (50.8)	1.5" (38.1)	3.75" (95.25)	4.0" (101.6)	2.0" (50.8)	2.20" (55.88)	1	1000

Dimensions are approximate and subject to technical changes. Use **Part No.** for ordering and **Type** for specification purposes.

* TAG38T4-100B and TAG7T1-100B require that 256K of memory be installed in the TT1000 printer and 384K of memory in the TT300SM printer

Thermal Transfer Self-Laminating Labels *continued*

(Not shown to scale)

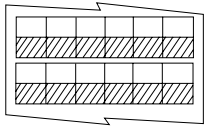

TAG26T6-100B

A

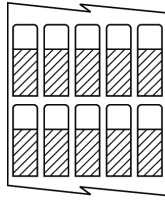

TAG2T5-100B

B

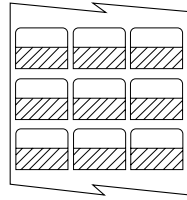

TAG51T3-100B

C

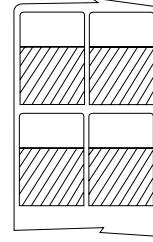

TAG22T2-100B

D

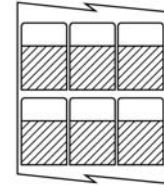

TAG22T3-100B

E

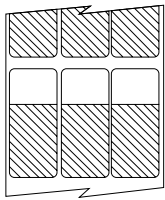

TAG9T3-100B

F

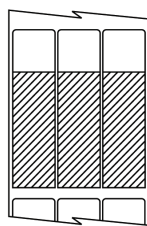

TAG3T3-100B

G

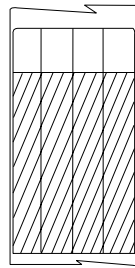

TAG38T4-100B

H

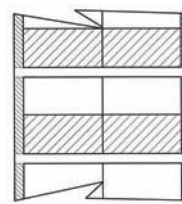

TAG53T2-100B

I

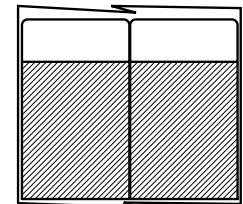

TAG1T1-100B

J

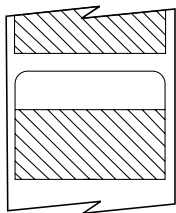

TAG24T1-100B

K

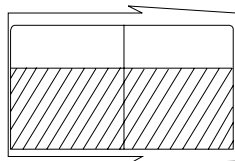

TAG10T2-100B

L

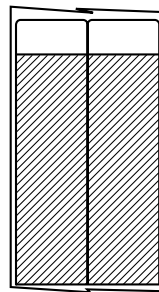

TAG7T1-100B

M

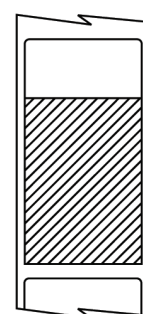

TAG6T1-100B

N

Self-Laminating Laser Tags

HellermannTyton self-laminating Laser Tags are durable, yet conformable to compound surfaces like wires and cables. These labels can be wrapped onto wires without fear of flagging or popping off the wires. The clear overlap protects printed information. Self-laminating Laser Tags are made of 1.0 MIL polyester (105 material).

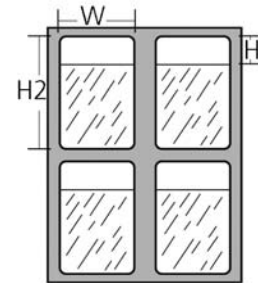

Product Selection

Article No.	Part No.	Type	Drawing References (page 37)	Width (W)		Height of Printable Area (H)		Height of Label (H2)		Labels per Row	Labels per Column	Labels per Sheet	Pkg. Qty.
				In.	(mm.)	In.	(mm.)	In.	(mm.)				
105 Material													
594-26105	TAG26L-105	TAG26L	A	.5"	(12.70)	.375"	(9.5)	.75"	(19.0)	16	16	156	5000
594-02105	TAG2L-105	TAG2L	B	.5"	(12.70)	.5"	(12.7)	1.43"	(36.5)	16	7	112	5000
594-05105	TAG5L-105	TAG5L	C	.8"	(20.30)	.5"	(12.7)	1.43"	(36.4)	8	7	56	5000
594-65105	TAG65L-105	TAG65L	D	.81"	(20.70)	.81"	(20.7)	2.13"	(53.9)	9	4	36	1000
594-51105	TAG51L-105	TAG51L	E	1.0"	(25.40)	.35"	(8.89)	.75"	(19.0)	8	12	84	5000
594-49105	TAG49L-105	TAG49L	F	1.0"	(25.40)	.35"	(8.8)	1.0"	(25.5)	8	8	70	2500
594-63105	TAG63L-105	TAG63L	G	1.0"	(25.40)	.5"	(12.7)	1.33"	(33.78)	8	7	49	2500
594-09105	TAG9L-105	TAG9L	H	1.0"	(25.40)	.75"	(19.00)	2.25"	(57.1)	7	4	28	1000
594-50105	TAG50L-105	TAG50L	I	1.0"	(25.40)	1.0"	(25.4)	3.16"	(80.4)	8	3	21	1000
594-64105	TAG64L-105	TAG64L	J	1.17"	(29.6)	.83"	(21.08)	3.33"	(84.6)	6	3	18	1000
594-01105	TAG1L-105	TAG1L	K	1.9"	(48.20)	.75"	(19.0)	3.25"	(82.5)	4	3	12	1000
594-52105	TAG52L-105	TAG52L	L	2.0"	(50.80)	.47"	(33.70)	1.33"	(33.7)	3	7	21	1000
594-10105	TAG10L-105	TAG10L	M	2.0"	(50.8)	.75"	(19.1)	2.25"	(57.2)	4	4	16	1000

Dimensions are approximate and subject to technical changes. Use **Part No.** for ordering and **Type** for specification purposes.

Self-Laminating LaserTags *continued*

(Not shown to scale)

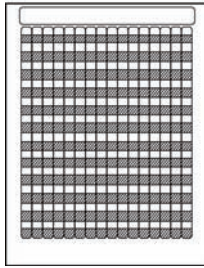

TAG26L-105

A

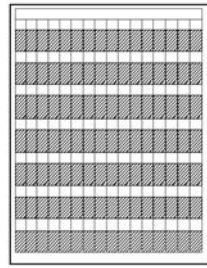

TAG2L-105

B

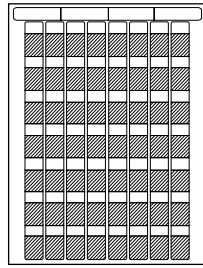

TAG5L-105

C

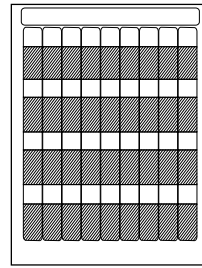

TAG65L-105

D

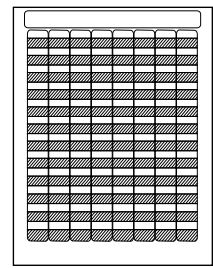

TAG51L-105

E

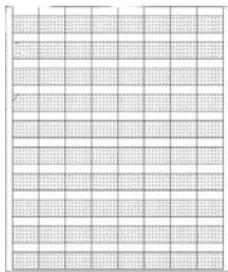

TAG49L-105

F

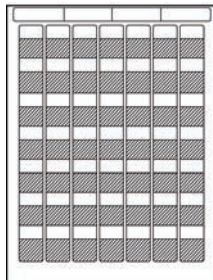

TAG63L-105

G

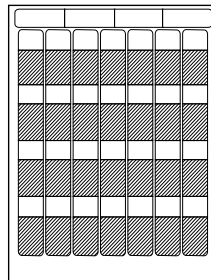

TAG9L-105

H

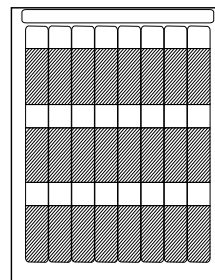

TAG50L-105

I

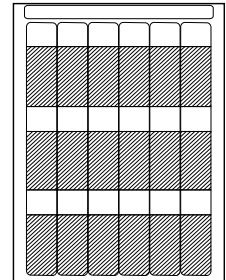

TAG64L-105

J

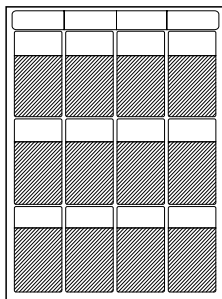

TAG1L-105

K

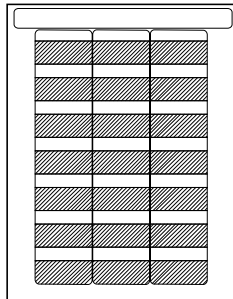

TAG52L-105

L

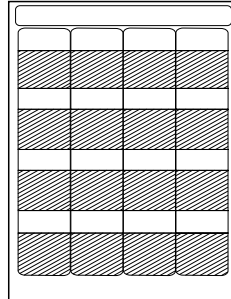

TAG10L-105

M

Index by Part No.

Part No.	Article No.	Page	Part No.	Article No.	Page	Part No.	Article No.	Page	Part No.	Article No.	Page
AT2000	120-00000	5	BC10	591-00076	21	553-50012	553-50012	28	553-50065	553-50065	29
AT2060	103-00000	6	HHDTH	557-00075	21	553-50013	553-50013	28	553-50066	553-50066	29
ATBENCHMOUNT	120-00040	7	HHHST	557-00092	21	553-50014	553-50014	28	553-50082	553-50082	29
AT06500020	120-00020	9	HHIGR	557-00009	21	553-50063	553-50063	28	553-50083	553-50083	29
AT06500030	120-00030	9	RBP1	557-00003	21	553-50064	553-50064	28	553-50084	553-50084	29
HH-20	120-00080	9	105910-155	556-03018	22	553-50067	553-50067	28	553-50085	553-50085	29
ATS10200010	102-00010	11	CADDY5.0	556-03022	22	553-50068	553-50068	28	553-50086	553-50086	29
ATS10200040	102-00040	11	TT320SM	556-00320	22	553-50069	553-50069	28	553-50087	553-50087	29
ATS10200050	102-00050	11	TT822OUTSM	556-00145	22	553-50070	553-50070	28	553-50089	553-50089	29
ATS10266109	102-66109	11	TT822OUTSM10	556-00146	22	553-50071	553-50071	28	TAG10T2-100B	596-00002	30
ATS10266110	102-66110	11	TT822OUTSM2	556-00147	22	553-50072	553-50072	28	TAG11T-100B	596-00005	30
ATS10266209	102-66209	11	TT822OUTSM3	556-00148	22	553-50073	553-50073	28	TAG22T2-100B	596-00006	30
ATS10266210	102-66210	11	TT822OUTSM4	556-00149	22	553-50074	553-50074	28	TAG22T3-100B	596-00007	30
ATS3080	102-00000	11	TT822OUTSM5	556-00150	22	553-50075	553-50075	28	TAG24T1-100B	596-00008	30
ATSTROLLEY	102-00030	11	TT822OUTSM6	556-00151	22	553-50076	553-50076	28	TAG26T6-100B	596-00009	30
QS101	105-00000	12	TT822OUTSM7	556-00152	22	553-50077	553-50077	28	TAG2T5-100B	596-00010	30
QTTIE9	105-00006	12	TT822OUTSM8	556-00153	22	553-50078	553-50078	28	TAG38T4-100B	596-00011	30
QTTIEOHS	105-00001	12	TTDTHOUTSM	556-00143	22	553-50079	553-50079	28	TAG3T3-100B	596-00013	30
MK7P	110-07101	14	TTHSTOUTSM	556-00163	22	553-50080	553-50080	28	TAG51T3-100B	596-00014	30
MK7P-342	110-07111	14	556-26008	556-26008	25	553-50081	553-50081	28	TAG53T2-100B	596-00045	30
MK9P	110-09101	15	556-26006	556-26006	25	553-50088	553-50088	28	TAG6T1-100B	596-00016	30
MK9P-109	110-09111	15	556-26007	556-26007	25	553-50177	553-50177	28	TAG7T1-100B	596-00021	30
MK9PUA	110-09112	15	556-26009	556-26009	25	553-50015	553-50015	29	TAG9T3-100B	596-00027	30
MKPCOBELT	110-09006	15	112-02809	T18S9M4	25	553-50016	553-50016	29	TAG10L-105	594-10105	32
MKPCOHOSE	110-09005	15	111-02811	T18S0M4	25	553-50017	553-50017	29	TAG1L-105	594-01105	32
MKPCOKIT	110-09002	15	111-01872	T18R9M4	25	553-50018	553-50018	29	TAG26L-105	594-26105	32
MKPCOTANK	110-09003	15	111-01841	T18R0M4	25	553-50019	553-50019	29	TAG2L-105	594-02105	32
MKPCOTANK20	110-09004	15	111-02322	T18I9M4	25	553-50020	553-50020	29	TAG49L-105	594-49105	32
MK7	110-07500	17	111-02315	T18I0M4	25	553-50021	553-50021	29	TAG50L-105	594-50105	32
MK7-449	110-00449	17	111-02026	T18L9M4	25	553-50022	553-50022	29	TAG51L-105	594-51105	32
MK7BLADEKIT	110-00448	17	111-02015	T18L0M4	25	553-50023	553-50023	29	TAG52L-105	594-52105	32
MK7HT	110-07000	17	111-03047	T30R9M4	25	553-50024	553-50024	29	TAG5L-105	594-05105	32
MK7LK	110-08000	17	111-03034	T30R0M4	25	553-50025	553-50025	29	TAG63L-105	594-63105	32
MK9	110-09500	18	111-03327	T30L9M4	25	553-50026	553-50026	29	TAG64L-105	594-64105	32
MK9-221	110-00221	18	111-03315	T30L0M4	25	553-50027	553-50027	29	TAG65L-105	594-65105	32
MK9BLADEKIT	110-00220	18	111-03517	T30LL9M4	25	553-50028	553-50028	29	TAG9L-105	594-09105	32
MK9HT	110-09000	18	111-03511	T30LL0M4	25	553-50029	553-50029	29			
MK9RE	110-09700	18	111-02907	T30XL9M4	25	553-50030	553-50030	29			
MK9REF	110-09600	18	111-02903	T30XL0M4	25	553-50031	553-50031	29			
MK9SS-114	110-05114	18	553-50001	553-50001	28	553-50032	553-50032	29			
MK9SST	110-95000	18	553-50002	553-50002	28	553-50033	553-50033	29			
558-00060	558-00060	19	553-50003	553-50003	28	553-50034	553-50034	29			
556-00022	556-00022	20	553-50004	553-50004	28	553-50035	553-50035	29			
556-00024	556-00024	20	553-50005	553-50005	28	553-50036	553-50036	29			
HT2100	557-00085	21	553-50006	553-50006	28	553-50037	553-50037	29			
2100AC	591-00003	21	553-50007	553-50007	28	553-50038	553-50038	29			
2100CABLE	557-00004	21	553-50008	553-50008	28	553-50039	553-50039	29			
2100CARD	557-00008	21	553-50009	553-50009	28	553-50040	553-50040	29			
2100CASE	557-00002	21	553-50010	553-50010	28	553-50041	553-50041	29			
2100PEN	557-00005	21	553-50011	553-50011	28	553-50042	553-50042	29			

Article No.	Part No.	Page	Article No.	Part No.	Page	Article No.	Part No.	Page	Article No.	Part No.	Page
102-00000	ATS3080	11	553-50015	553-50015	29	553-50177	553-50177	28	596-00014	TAG51T3-100B	30
102-00010	ATS10200010	11	553-50016	553-50016	29	556-00022	556-00022	20	596-00016	TAG6T1-100B	30
102-00030	ATSTROLLEY	11	553-50017	553-50017	29	556-00024	556-00024	20	596-00021	TAG7T1-100B	30
102-00040	ATS10200040	11	553-50018	553-50018	29	556-00143	TTDTHOUTSM	22	596-00027	TAG9T3-100B	30
102-00050	ATS10200050	11	553-50019	553-50019	29	556-00145	TT822OUTSM	22	596-00045	TAG53T2-100B	30
102-66109	ATS10266109	11	553-50020	553-50020	29	556-00146	TT822OUTSM10	22	T18I0M4	111-02315	25
102-66110	ATS10266110	11	553-50021	553-50021	29	556-00147	TT822OUTSM2	22	T18I9M4	111-02322	25
102-66209	ATS10266209	11	553-50022	553-50022	29	556-00148	TT822OUTSM3	22	T18L0M4	111-02015	25
102-66210	ATS10266210	11	553-50023	553-50023	29	556-00149	TT822OUTSM4	22	T18L9M4	111-02026	25
103-00000	AT2060	6	553-50024	553-50024	29	556-00150	TT822OUTSM5	22	T18R0M4	111-01841	25
105-00000	QS101	12	553-50025	553-50025	29	556-00151	TT822OUTSM6	22	T18R9M4	111-01872	25
105-00001	QTTIEOHS	12	553-50026	553-50026	29	556-00152	TT822OUTSM7	22	T18S0M4	111-02811	25
105-00006	QTTIE9	12	553-50027	553-50027	29	556-00153	TT822OUTSM8	22	T18S9M4	112-02809	25
110-00220	MK9BLADEKIT	18	553-50028	553-50028	29	556-00163	TTHTSTOUTSM	22	T30L0M4	111-03315	25
110-00221	MK9-221	18	553-50029	553-50029	29	556-00320	TT320SM	22	T30L9M4	111-03327	25
110-00448	MK7BLADEKIT	17	553-50030	553-50030	29	556-03018	105910-155	22	T30LL0M4	111-03511	25
110-00449	MK7-449	17	553-50031	553-50031	29	556-03022	CADDY5.0	22	T30LL9M4	111-03517	25
110-05114	MK9SS-114	18	553-50032	553-50032	29	556-26006	556-26006	25	T30R0M4	111-03034	25
110-07000	MK7HT	17	553-50033	553-50033	29	556-26007	556-26007	25	T30R9M4	111-03047	25
110-07101	MK7P	14	553-50034	553-50034	29	556-26008	556-26008	25	T30XL0M4	111-02903	25
110-07111	MK7P-342	14	553-50035	553-50035	29	556-26009	556-26009	25	T30XL9M4	111-02907	25
110-07500	MK7	17	553-50036	553-50036	29	557-00002	2100CASE	21			
110-08000	MK7LK	17	553-50037	553-50037	29	557-00003	RBP1	21			
110-09000	MK9HT	18	553-50038	553-50038	29	557-00004	2100CABLE	21			
110-09002	MKPCOKIT	15	553-50039	553-50039	29	557-00005	2100PEN	21			
110-09003	MKPCOTANK	15	553-50040	553-50040	29	557-00008	2100CARD	21			
110-09004	MKPCOTANK20	15	553-50041	553-50041	29	557-00009	HHIGR	21			
110-09005	MKPCOHOSE	15	553-50042	553-50042	29	557-00075	HHHST	21			
110-09006	MKPCOBELT	15	553-50063	553-50063	28	557-00085	HT2100	21			
110-09101	MK9P	15	553-50064	553-50064	28	557-00092	HHHST	21			
110-09111	MK9P-109	15	553-50065	553-50065	29	558-00060	558-00060	19			
110-09112	MK9PUA	15	553-50066	553-50066	29	591-00003	2100AC	21			
110-09500	MK9	18	553-50067	553-50067	28	591-00076	BC10	21			
110-09600	MK9REF	18	553-50068	553-50068	28	594-01105	TAG1L-105	32			
110-09700	MK9RE	18	553-50069	553-50069	28	594-02105	TAG2L-105	32			
110-95000	MK9SST	18	553-50070	553-50070	28	594-05105	TAG5L-105	32			
120-00000	AT2000	5	553-50071	553-50071	28	594-09105	TAG9L-105	32			
120-00020	AT06500020	9	553-50072	553-50072	28	594-10105	TAG10L-105	32			
120-00030	AT06500030	9	553-50073	553-50073	28	594-26105	TAG26L-105	32			
120-00040	ATBENCHMOUNT	7	553-50074	553-50074	28	594-49105	TAG49L-105	32			
120-00080	HH-20	9	553-50075	553-50075	28	594-50105	TAG50L-105	32			
553-50001	553-50001	28	553-50076	553-50076	28	594-51105	TAG51L-105	32			
553-50002	553-50002	28	553-50077	553-50077	28	594-52105	TAG52L-105	32			
553-50003	553-50003	28	553-50078	553-50078	28	594-63105	TAG63L-105	32			
553-50004	553-50004	28	553-50079	553-50079	28	594-64105	TAG64L-105	32			
553-50005	553-50005	28	553-50080	553-50080	28	594-65105	TAG65L-105	32			
553-50006	553-50006	28	553-50081	553-50081	28	596-00002	TAG10T2-100B	30			
553-50007	553-50007	28	553-50082	553-50082	29	596-00005	TAG1T1-100B	30			
553-50008	553-50008	28	553-50083	553-50083	29	596-00006	TAG22T2-100B	30			
553-50009	553-50009	28	553-50084	553-50084	29	596-00007	TAG22T3-100B	30			
553-50010	553-50010	28	553-50085	553-50085	29	596-00008	TAG24T1-100B	30			
553-50011	553-50011	28	553-50086	553-50086	29	596-00009	TAG26T6-100B	30			
553-50012	553-50012	28	553-50087	553-50087	29	596-00010	TAG2T5-100B	30			
553-50013	553-50013	28	553-50088	553-50088	28	596-00011	TAG38T4-100B	30			
553-50014	553-50014	28	553-50089	553-50089	29	596-00013	TAG3T3-100B	30			



Corporate Headquarters and Manufacturing

Milwaukee, WI



Distribution

Bolingbrook, IL



Manufacturing

Naples, FL

Sales and Distribution

Tlaquepaque, Jalisco Mexico

Sales and Distribution

Aurora, Ontario Canada

QUALITY CERTIFICATIONS

HellermannTyton is certified to TS 16949, ISO 9001:2000 and ISO 14001

RoHS/WEEE



The scope of the European Union's Restriction of Hazardous Substances (RoHS) and the Waste Electrical and Electronic Equipment (WEEE) directives covers all electrical and electronic equipment (and their components) sold into the European Union. Throughout this catalog, you will see designations where materials are RoHS compliant. If you have specific questions or need compliance information related to the RoHS or WEEE directives, please go to our website link:

www.hellermann.tyton.com/rohs.asp or email us at: rohs@htamericas.com. A HellermannTyton representative will promptly respond to your request.

WARRANTY POLICY

HellermannTyton products are warranted to be free from defects in material and workmanship at the time sold by us; but our obligation under this warranty and that of the seller is limited to the replacement of the product, and neither we nor the seller are bound by any other warranty, expressed, implied or statutory. Under no circumstances are we or the seller liable for any loss, damage, expenses or consequential damages of any kind arising out of the use or inability to use these products. All are sold with the understanding that the user will test them in actual use and determine their adaptability for the intended uses.

The above warranties and remedies are exclusive and in lieu of all other warranties and remedies whatsoever, express or implied, including, but not limited to, any implied warranties of merchantability or fitness for a particular purpose which HellermannTyton expressly disclaims.