

## Ultra low drop and low noise BiCMOS voltage regulators

Datasheet - production data

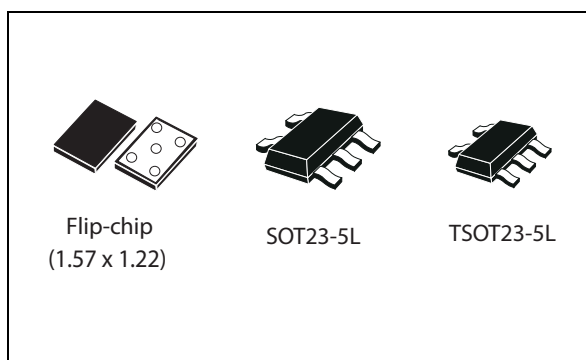

- Internal current and thermal limit
- Output low noise voltage  $30 \mu\text{V}_{\text{RMS}}$  over 10 Hz to 100 kHz
- SVR of 60 dB at 1 kHz, 50 dB at 10 kHz
- Temperature range: - 40 °C to 125 °C

### Description

The LD3985 provides up to 150 mA, from 2.5 V to 6 V input voltage. The ultra low drop voltage, low quiescent current and low noise make it suitable for low power applications and in battery-powered systems. Regulator ground current increases slightly in dropout only, prolonging the battery life. Power supply rejection is better than 60 dB at low frequencies and rolls off at 10 kHz. High power supply rejection is maintained down to low input voltage levels common to battery operated circuits. Shutdown logic control function is available, this means that when the device is used as local regulator, it is possible to put a part of the board in standby, decreasing the total power consumption. The LD3985 is designed to work with low ESR ceramic capacitors. Typical applications are in mobile phones and similar battery-powered wireless systems.

### Features

- Input voltage from 2.5 V to 6 V
- Stable with low ESR ceramic capacitors
- Ultra low-dropout voltage (60 mV typ. at 150 mA load, 0.4 mV typ. at 1 mA load)
- Very low quiescent current (85  $\mu\text{A}$  typ. at no load, 170  $\mu\text{A}$  typ. at 150 mA load; max. 1.5  $\mu\text{A}$  in OFF mode)
- Guaranteed output current up to 150 mA
- Wide range of output voltage: 1.22 V; 1.8 V; 2.5 V; 2.6 V; 2.7 V; 2.8 V; 2.9 V; 3 V; 3.3 V; 4.7 V
- Fast turn-on time: typ. 200  $\mu\text{s}$  [ $C_{\text{O}} = 1 \mu\text{F}$ ,  $C_{\text{BYP}} = 10 \text{ nF}$  and  $I_{\text{O}} = 1 \text{ mA}$ ]
- Logic-controlled electronic shutdown

Table 1. Device summary

Part numbers	
LD3985XX122	LD3985XX28
LD3985XX18	LD3985XX29
LD3985XX25	LD3985XX30
LD3985XX26	LD3985XX33
LD3985XX27	LD3985XX47

# Contents

1	Diagram .....	3
2	Pin configuration .....	4
3	Typical application .....	5
4	Maximum ratings .....	6
5	Electrical characteristics .....	7
6	Typical performance characteristics .....	9
7	Package mechanical data .....	13
8	Packaging mechanical data .....	18
9	Order codes .....	20
10	Revision history .....	21

# 1 Diagram

Figure 1. Schematic diagram

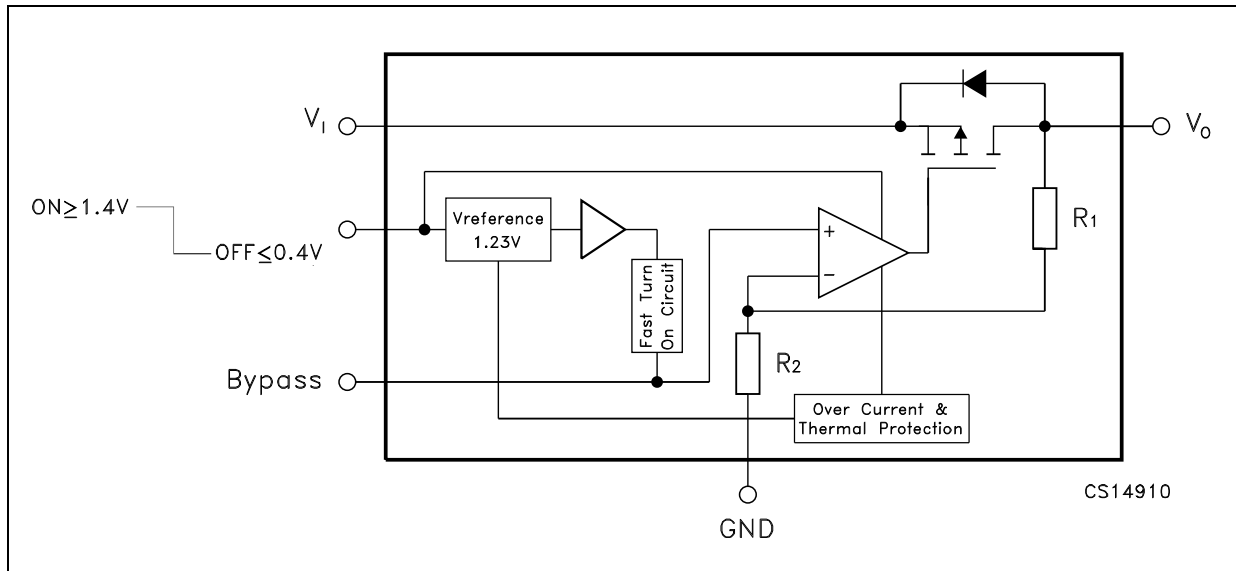

## 2 Pin configuration

Figure 2. Pin connections (SOT and TSOT top view, Flip-chip top view)

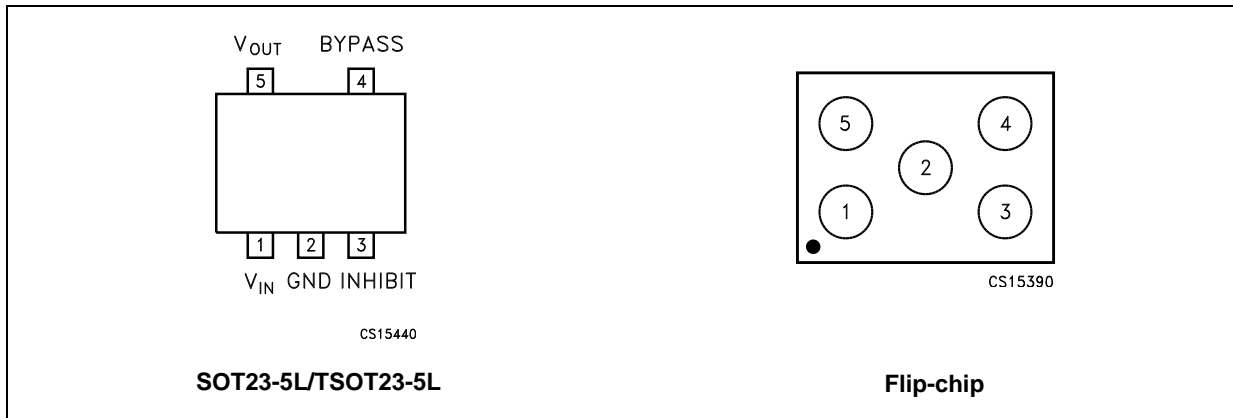
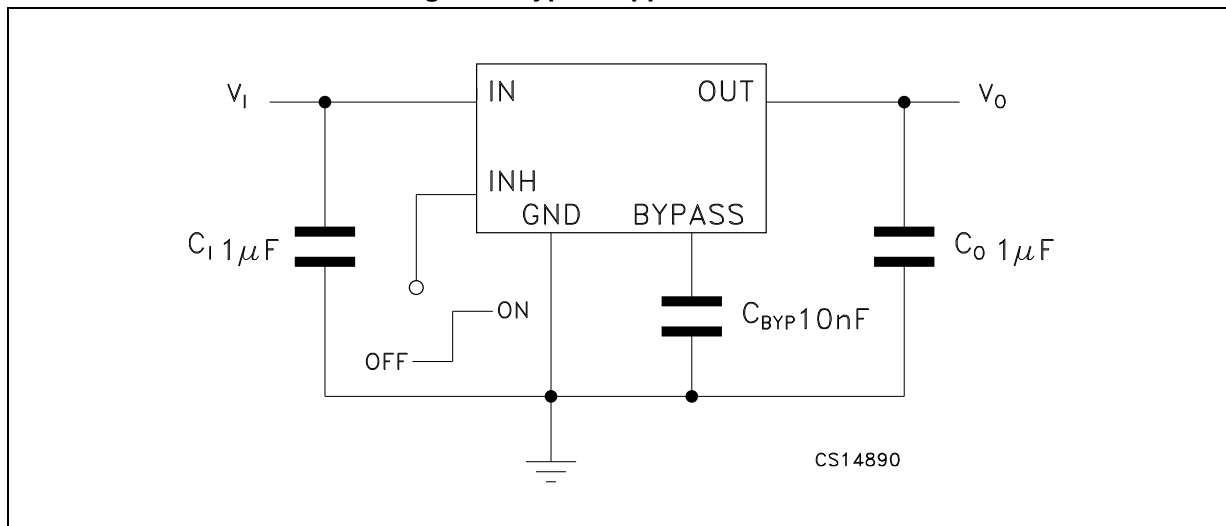

Table 2. Pin description

Pin n° for SOT23-5L/TSOT23-5L	Pin n° for Flip-chip	Symbol	Name and function
1	4	$V_I$	Input voltage of the LDO
2	2	GND	Common ground
3	1	$V_{INH}$	Inhibit input voltage: ON mode when $V_{INH} \geq 1.2$ V, OFF mode when $V_{INH} \leq 0.4$ V (Do not leave it floating, not internally pulled down/up)
4	5	BYPASS	Bypass pin: an external capacitor (usually 10 nF) has to be connected to minimize noise voltage
5	3	$V_O$	Output voltage of the LDO

### 3 Typical application

Figure 3. Typical application circuit



## 4 Maximum ratings

**Table 3. Absolute maximum ratings**

Symbol	Parameter	Value	Unit
$V_I$	DC input voltage	-0.3 to 6 <sup>(1)</sup>	V
$V_O$	DC output voltage	-0.3 to $V_I+0.3$	V
$V_{INH}$	Inhibit input voltage	-0.3 to $V_I+0.3$	V
$I_O$	Output current	Internally limited	
$P_D$	Power dissipation	Internally limited	
$T_{STG}$	Storage temperature range	-65 to 150	°C
$T_{OP}$	Operating junction temperature range	-40 to 125	°C

1. The input pin is able to withstand non repetitive spike of 6.5 V for 200 ms.

*Note: Absolute maximum ratings are those values beyond which damage to the device may occur. Functional operation under these conditions is not implied.*

**Table 4. Thermal data**

Symbol	Parameter	SOT23-5L/ TSOT23	Flip-chip	Unit
$R_{thJC}$	Thermal resistance junction-case	81		°C/W
$R_{thJA}$	Thermal resistance junction-ambient	255	170	°C/W

## 5 Electrical characteristics

$T_J = 25\text{ °C}$ ,  $V_I = V_{O(NOM)} + 0.5\text{ V}$ ,  $C_I = 1\text{ }\mu\text{F}$ ,  $C_{BYP} = 10\text{ nF}$ ,  $I_O = 1\text{ mA}$ ,  $V_{INH} = 1.4\text{ V}$ , unless otherwise specified.

Table 5. LD3985 electrical characteristics

Symbol	Parameter	Test conditions	Min.	Typ.	Max.	Unit
$V_I$	Operating input voltage		2.5		6	V
$V_O$	Output voltage accuracy, $V_{O(NOM)} < 2.5\text{ V}$	$I_O = 1\text{ mA}$	-50		50	mV
		$T_J = -40\text{ to }125\text{ °C}$	-75		75	
$V_O$	Output voltage accuracy, $V_{O(NOM)} \geq 2.5\text{ V}$	$I_O = 1\text{ mA}$	-2		2	% of $V_{O(NOM)}$
		$T_J = -40\text{ to }125\text{ °C}$	-3		3	
$\Delta V_O$	Line regulation <sup>(1)</sup>	$V_I = V_{O(NOM)} + 0.5\text{ to }6\text{ V}$ $T_J = -40\text{ to }125\text{ °C}$	-0.1		0.1	%/ $V$
		$V_{O(NOM)} = 4.7\text{ to }5\text{ V}$	-0.19		0.19	
$\Delta V_O$	Load regulation	$I_O = 1\text{ mA to }150\text{ mA}$ , $V_{O(NOM)} < 2.5\text{ V}$ $T_J = -40\text{ to }125\text{ °C}$		0.002	0.008	%/ $\text{mA}$
$\Delta V_O$	Load regulation	$I_O = 1\text{ mA to }150\text{ mA}$ , $V_{O(NOM)} \geq 2.5\text{ V}$ $T_J = -40\text{ to }125\text{ °C}$ (for flip-chip)		0.0004	0.002	%/ $\text{mA}$
		$I_O = 1\text{ mA to }150\text{ mA}$ , $T_J = -40\text{ to }125\text{ °C}$ (for SOT23-5L/TSOT23-5L), $V_{O(NOM)} \geq 2.5\text{ V}$		0.0025	0.005	
$\Delta V_O$	Output AC line regulation <sup>(2)</sup>	$V_I = V_{O(NOM)} + 1\text{ V}$ , $I_O = 150\text{ mA}$ , $t_R = t_F = 30\text{ }\mu\text{s}$		1.5		$\text{mV}_{PP}$
$I_Q$	Quiescent current ON mode: $V_{INH} = 1.2\text{ V}$	$I_O = 0$		85		$\mu\text{A}$
		$I_O = 0$ , $T_J = -40\text{ to }125\text{ °C}$			150	
		$I_O = 0\text{ to }150\text{ mA}$		170		
		$I_O = 0\text{ to }150\text{ mA}$ , $T_J = -40\text{ to }125\text{ °C}$			250	
OFF mode: $V_{INH} = 0.4\text{ V}$				0.003		
	$T_J = -40\text{ to }125\text{ °C}$				1.5	
$V_{DROP}$	Dropout voltage <sup>(3)</sup>	$I_O = 1\text{ mA}$		0.4		mV
		$I_O = 1\text{ mA}$ , $T_J = -40\text{ to }125\text{ °C}$			2	
		$I_O = 50\text{ mA}$		20		
		$I_O = 50\text{ mA}$ , $T_J = -40\text{ to }125\text{ °C}$			35	
		$I_O = 100\text{ mA}$		45		
		$I_O = 100\text{ mA}$ , $T_J = -40\text{ to }125\text{ °C}$			70	
		$I_O = 150\text{ mA}$		60		
$I_O = 150\text{ mA}$ , $T_J = -40\text{ to }125\text{ °C}$			100			
$I_{SC}$	Short-circuit current	$R_L = 0$		600		$\text{mA}$

Table 5. LD3985 electrical characteristics (continued)

Symbol	Parameter	Test conditions	Min.	Typ.	Max.	Unit
SVR	Supply voltage rejection	$V_I = V_{O(NOM)} + 0.25\text{ V} \pm$ $V_{RIPPLE} = 0.1\text{ V}$ , $I_O = 50\text{ mA}$ $V_{O(NOM)} < 2.5\text{ V}$ , $V_I = 2.55\text{ V}$	$f = 1\text{ kHz}$		60	dB
			$f = 10\text{ kHz}$		50	
$I_{O(PK)}$	Peak output current	$V_O \geq V_{O(NOM)} - 5\%$	300	550		mA
$V_{INH}$	Inhibit input logic low	$V_I = 2.5\text{ V to } 6\text{ V}$ , $T_J = -40\text{ to } 125\text{ }^\circ\text{C}$			0.4	V
	Inhibit input logic high		1.2			
$I_{INH}$	Inhibit input current	$V_{INH} = 0.4\text{ V}$ , $V_I = 6\text{ V}$		$\pm 1$		nA
eN	Output noise voltage	$B_W = 10\text{ Hz to } 100\text{ kHz}$ , $C_O = 1\text{ }\mu\text{F}$		30		$\mu\text{V}_{RMS}$
$t_{ON}$	Turn-on time <sup>(4)</sup>	$C_{BYP} = 10\text{ nF}$		100	250	$\mu\text{s}$
$T_{SHDN}$	Thermal shutdown	<sup>(5)</sup>		160		$^\circ\text{C}$
$C_O$	Output capacitor	Capacitance <sup>(6)</sup>	1		22	$\mu\text{F}$
		ESR	5		5000	m $\Omega$

1. For  $V_{O(NOM)} < 2\text{ V}$ ,  $V_I = 2.5\text{ V}$
2. For  $V_{O(NOM)} = 1.25\text{ V}$ ,  $V_I = 2.5\text{ V}$
3. Dropout voltage is the input-to-output voltage difference at which the output voltage is 100 mV below its nominal value. This specification does not apply to input voltages below 2.5 V
4. Turn-on time is time measured between the enable input just exceeding  $V_{INH}$  high value and the output voltage just reaching 95% of its nominal value
5. Typical thermal protection hysteresis is 20  $^\circ\text{C}$
6. The minimum capacitor value is 1  $\mu\text{F}$ , anyway the LD3985 is still stable if the compensation capacitor has a 30% tolerance in all temperature range



## 6 Typical performance characteristics

$T_J = 25\text{ }^\circ\text{C}$ ,  $V_I = V_{O(NOM)} + 0.5\text{ V}$ ,  $C_I = C_O = 1\text{ }\mu\text{F}$ ,  $C_{BYP} = 10\text{ nF}$ ,  $I_O = 1\text{ mA}$ ,  $V_{INH} = 1.4\text{ V}$ , unless otherwise specified.

**Figure 4. Output voltage vs. temperature**  
( $V_O = 1.35\text{ V}$ )

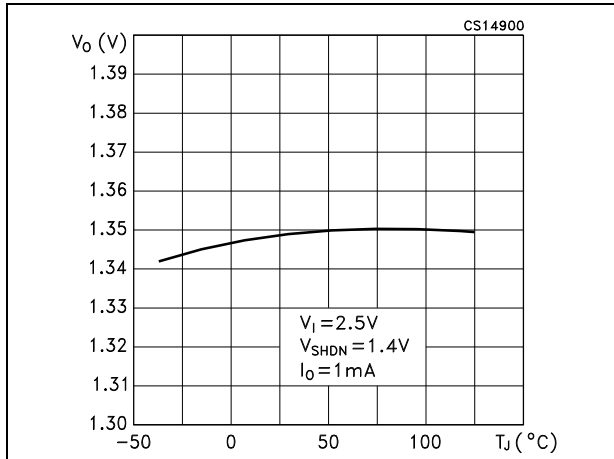

**Figure 5. Output voltage vs. temperature**  
( $V_O = 2.7\text{ V}$ )

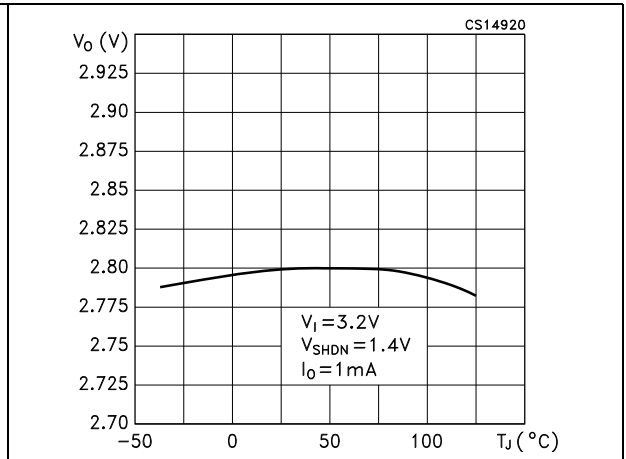

**Figure 6. Output voltage vs. temperature**  
( $V_O = 3.3\text{ V}$ )

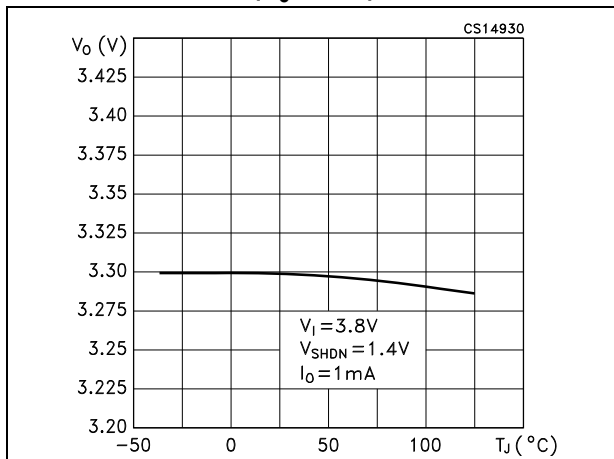

**Figure 7. Shutdown voltage vs. temperature**  
( $V_O = 1.35\text{ V}$ )

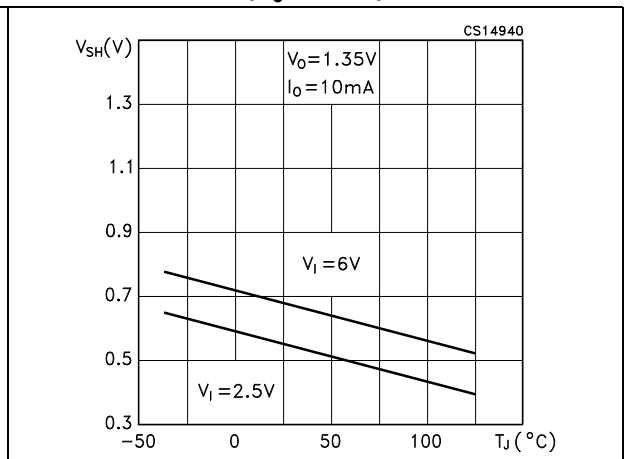

Figure 8. Shutdown voltage vs. temperature  
( $V_0=3.3\text{ V}$ )

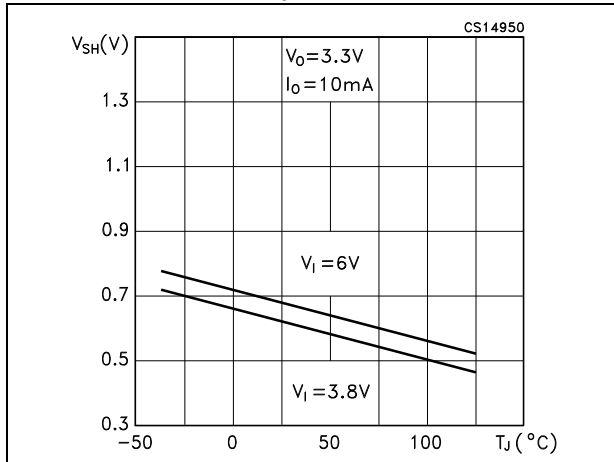

Figure 9. Line regulation vs. temperature  
( $V_0=1.35\text{ V}$ )

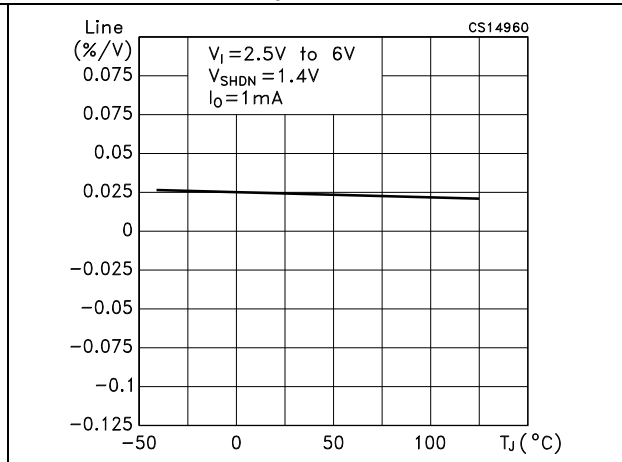

Figure 10. Line regulation vs. temperature  
( $V_0=2.7\text{ V}$ )

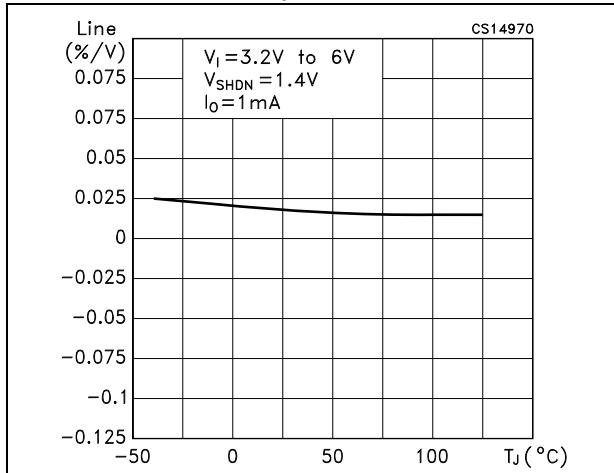

Figure 11. Line regulation vs. temperature  
( $V_0=3.3\text{ V}$ )

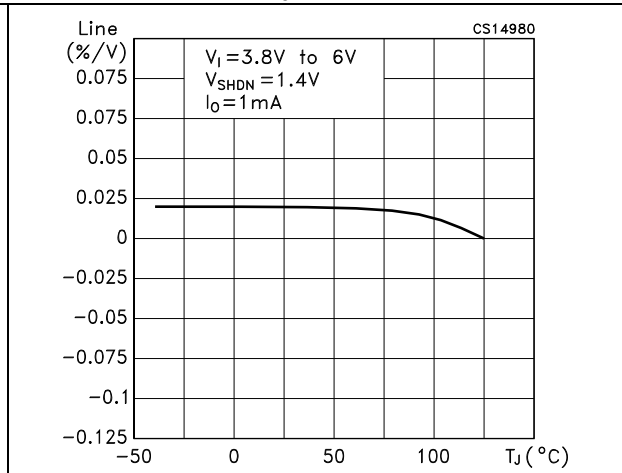

Figure 12. Load regulation vs. temperature  
( $V_0=1.35\text{ V}$ )

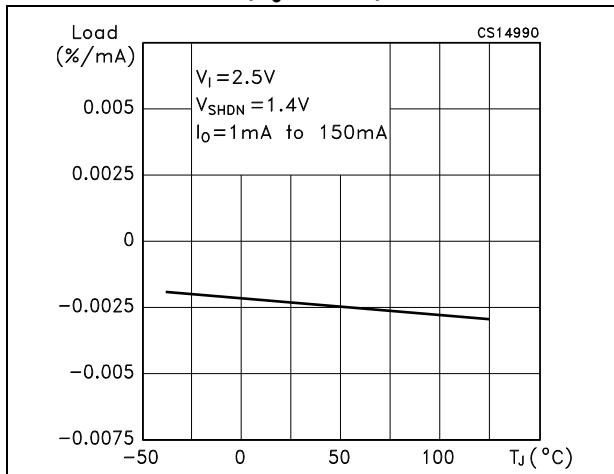

Figure 13. Load regulation vs. temperature  
( $V_0=2.7\text{ V}$ )

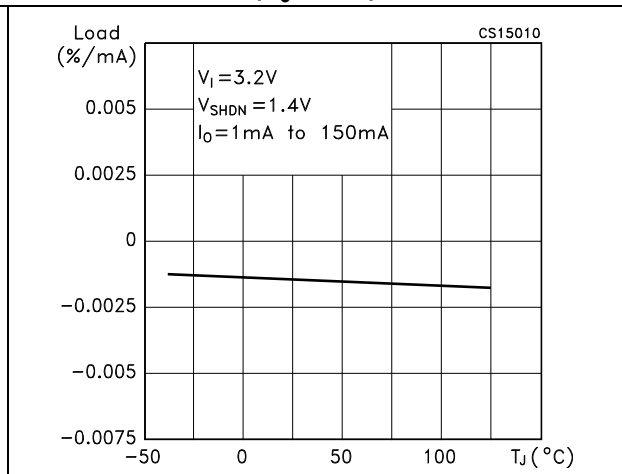

Figure 14. Load regulation vs. temperature ( $V_0=3.3\text{ V}$ )

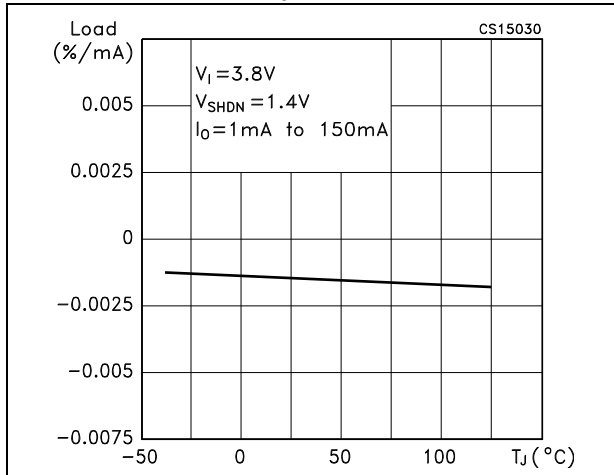

Figure 15. Quiescent current vs. temperature ( $V_I=2.5\text{ V}$ )

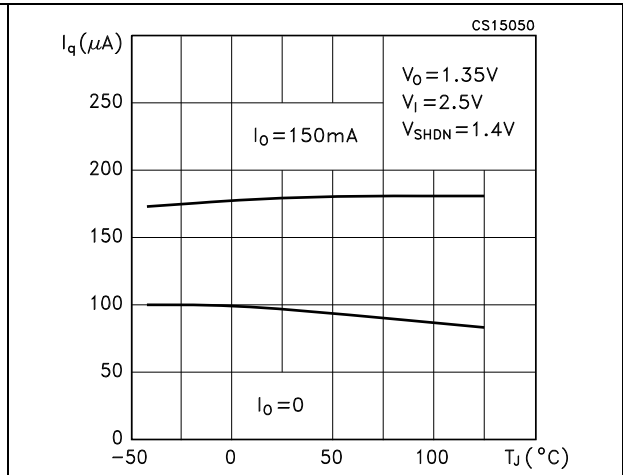

Figure 16. Quiescent current vs. temperature ( $V_I=6\text{ V}$ )

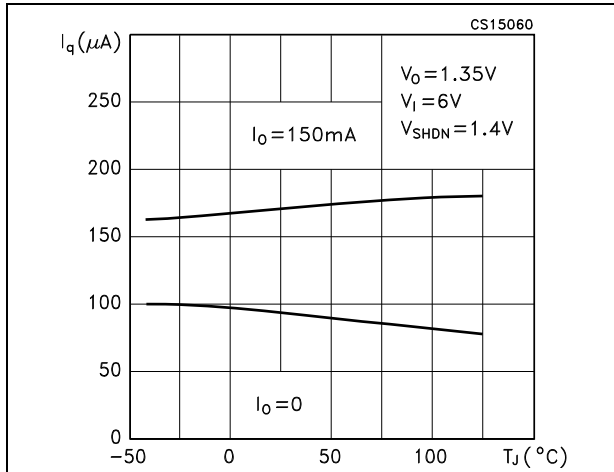

Figure 17. Quiescent current vs. load current

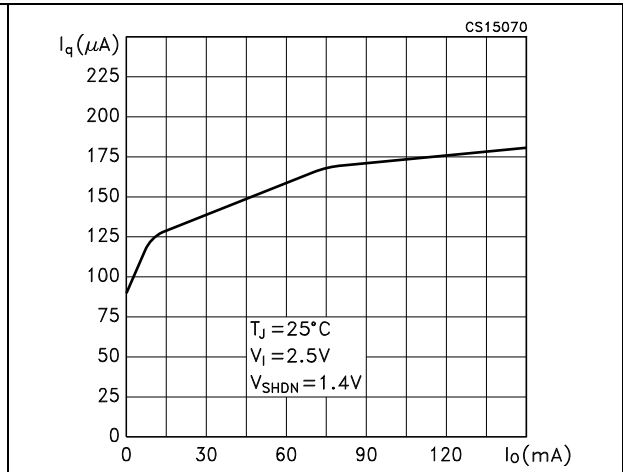

Figure 18. Supply voltage rejection vs. frequency

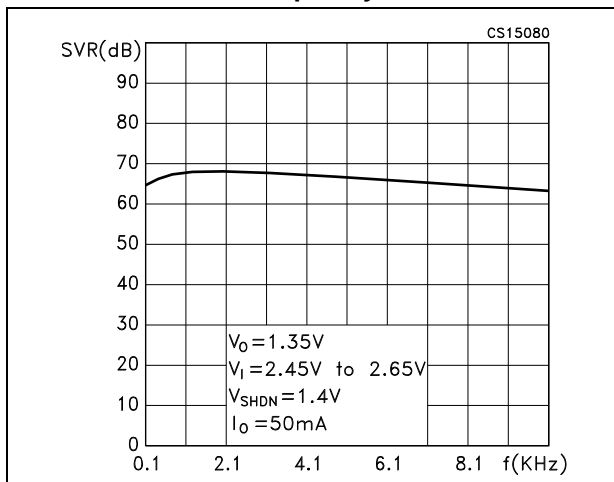

Figure 19. Load transient response

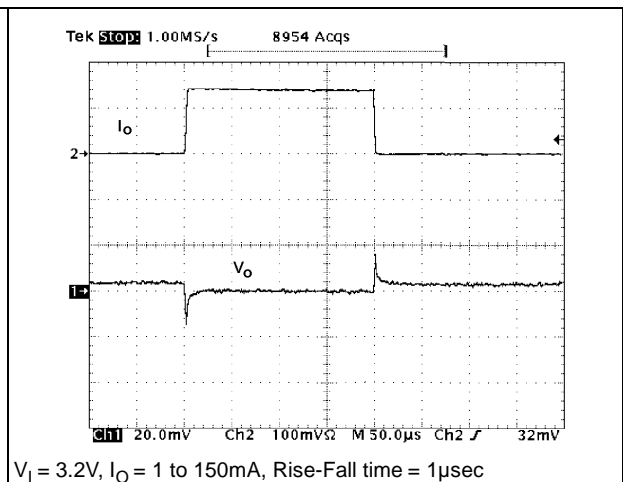

Figure 20. Line transient response

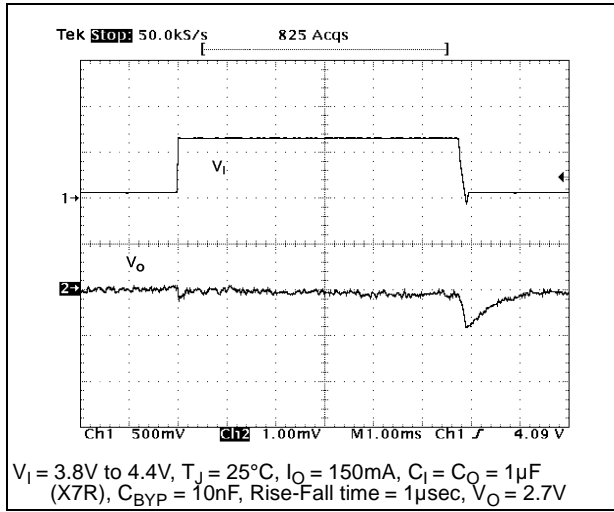

Figure 21. Start-up

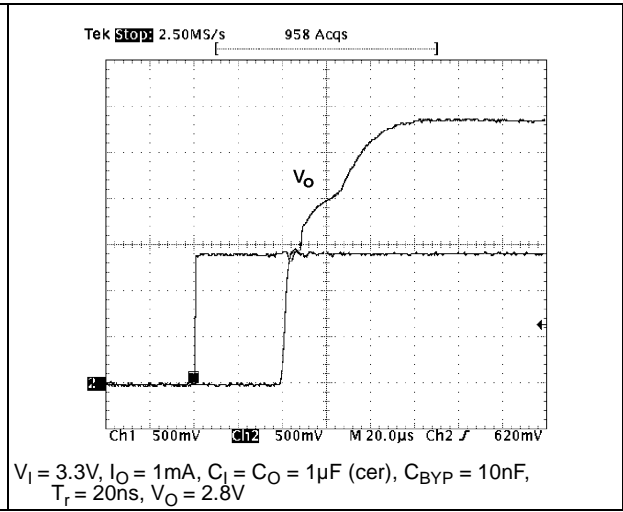
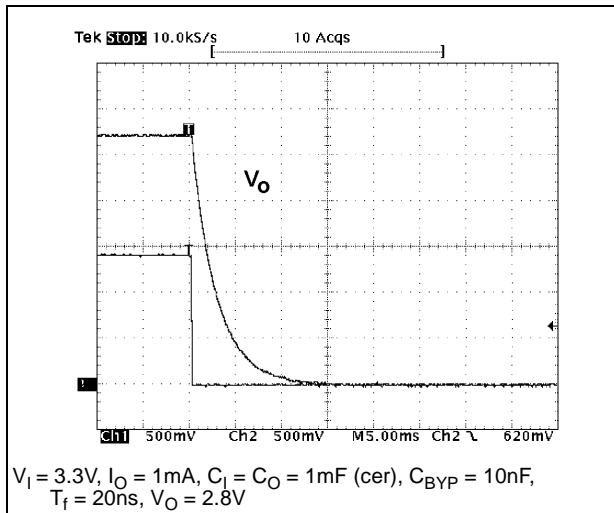

Figure 22. Turn-off



## 7 Package mechanical data

In order to meet environmental requirements, ST offers these devices in different grades of ECOPACK® packages, depending on their level of environmental compliance. ECOPACK® specifications, grade definitions and product status are available at: [www.st.com](http://www.st.com). ECOPACK® is an ST trademark.

Figure 23. Flip-chip 5 drawings

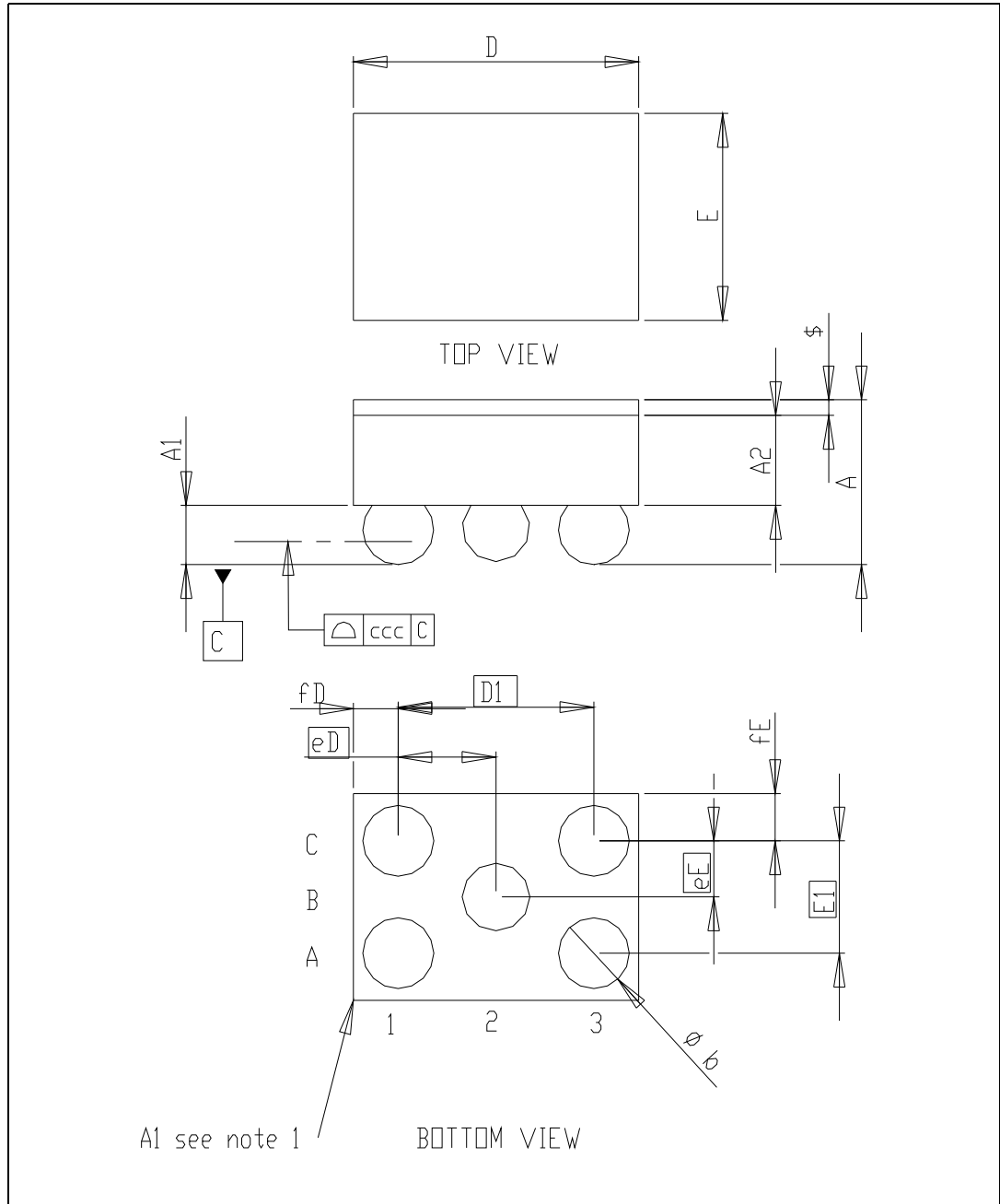
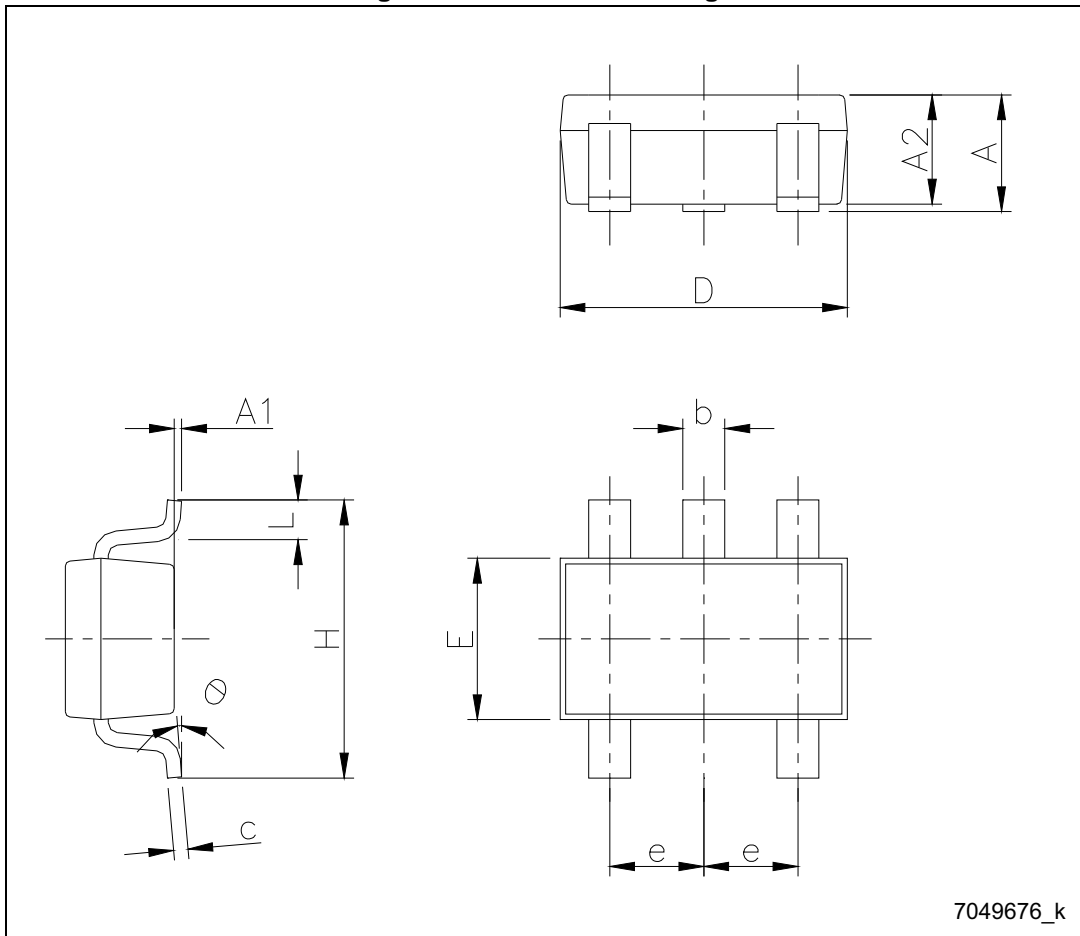

Table 6. Flip-chip 5 mechanical data

mm			
Dim.	Min.	Typ.	Max.
A	0.54	0.65	0.66
A1	0.21	0.25	0.29
A2	0.33	0.35	0.37
b	0.265	0.315	0.365
D	1.54	1.59	1.64
D1	0.83	0.87	0.91
E	1.19	1.24	1.29
E1	0.46	0.5	0.54
eD	0.395	0.435	0.475
eE	0.21	0.25	0.29
fD		0.360	
fE		0.370	
ccc		0.080	
\$		0.05	

Figure 24. SOT23-5L drawings



7049676\_k

Figure 25. SOT23-5L recommended footprint (dimensions in mm)

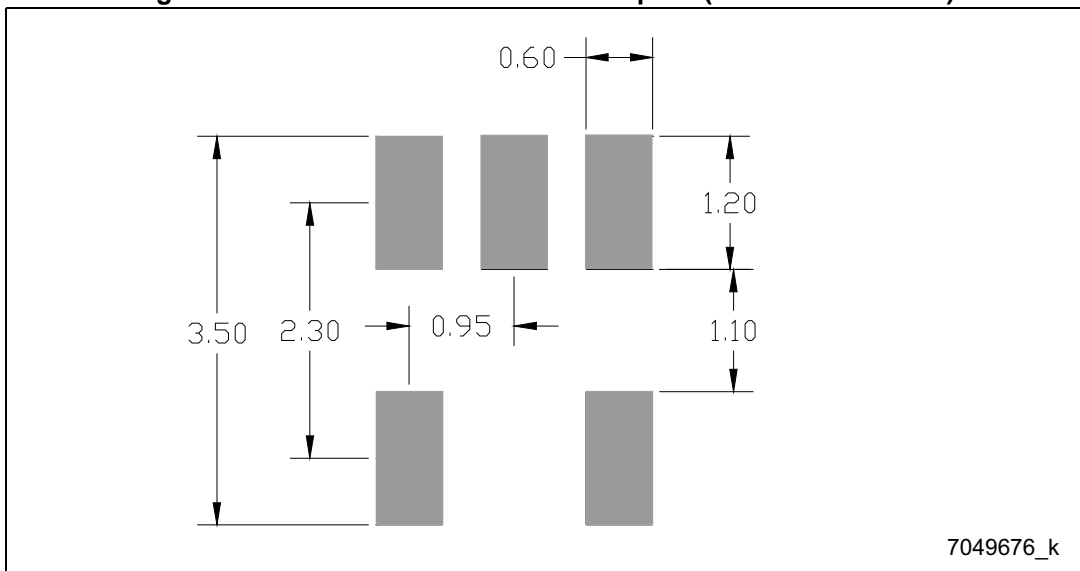

7049676\_k

Table 7. SOT23-5L mechanical data

Dim.	mm		
	Min.	Typ.	Max.
A	0.90		1.45
A1	0		0.15
A2	0.90		1.30
b	0.30		0.50
c	2.09		0.20
D		2.95	
E		1.60	
e		0.95	
H		2.80	
L	0.30		0.60
$\theta$	0		8



Figure 26. TSOT23-5L drawings

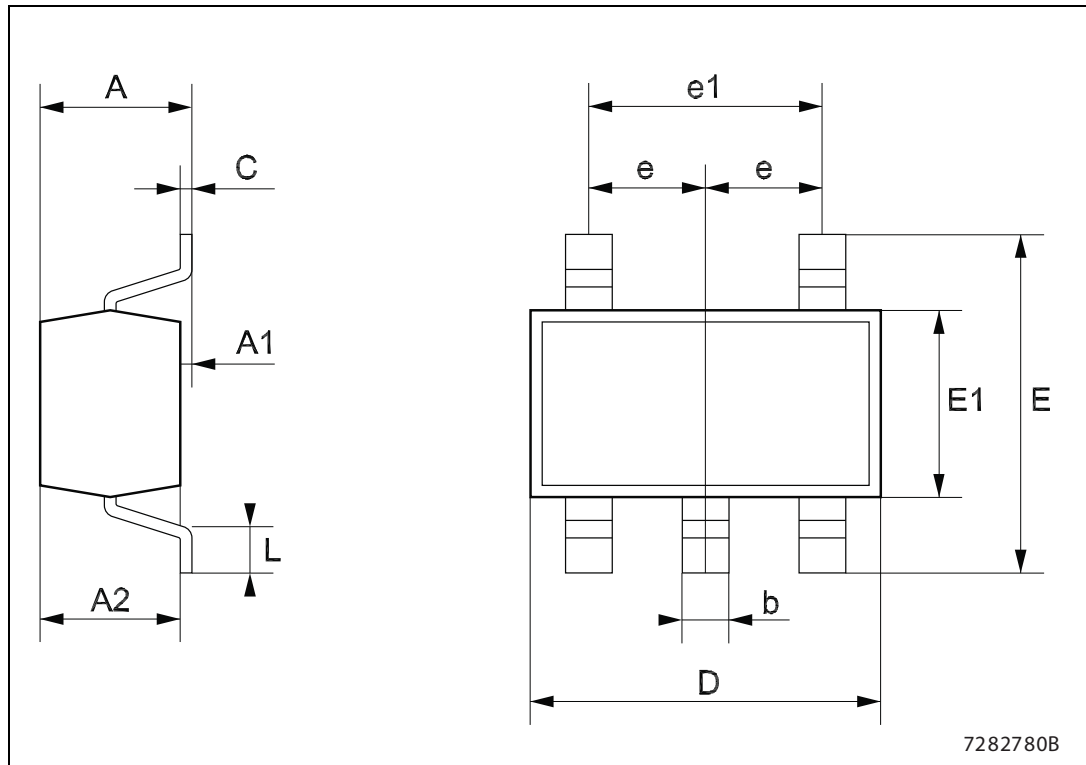

Table 8. TSOT23-5L mechanical data

Dim.	mm		
	Min.	Typ.	Max.
A			1.1
A1	0		0.1
A2	0.7		1.0
b	0.3		0.5
C	0.08		0.2
D		2.9	
E		2.8	
E1		1.6	
e		0.95	
e1		1.9	
L	0.3		0.6

## 8 Packaging mechanical data

Figure 27. TSOT23-5L tape and reel drawings

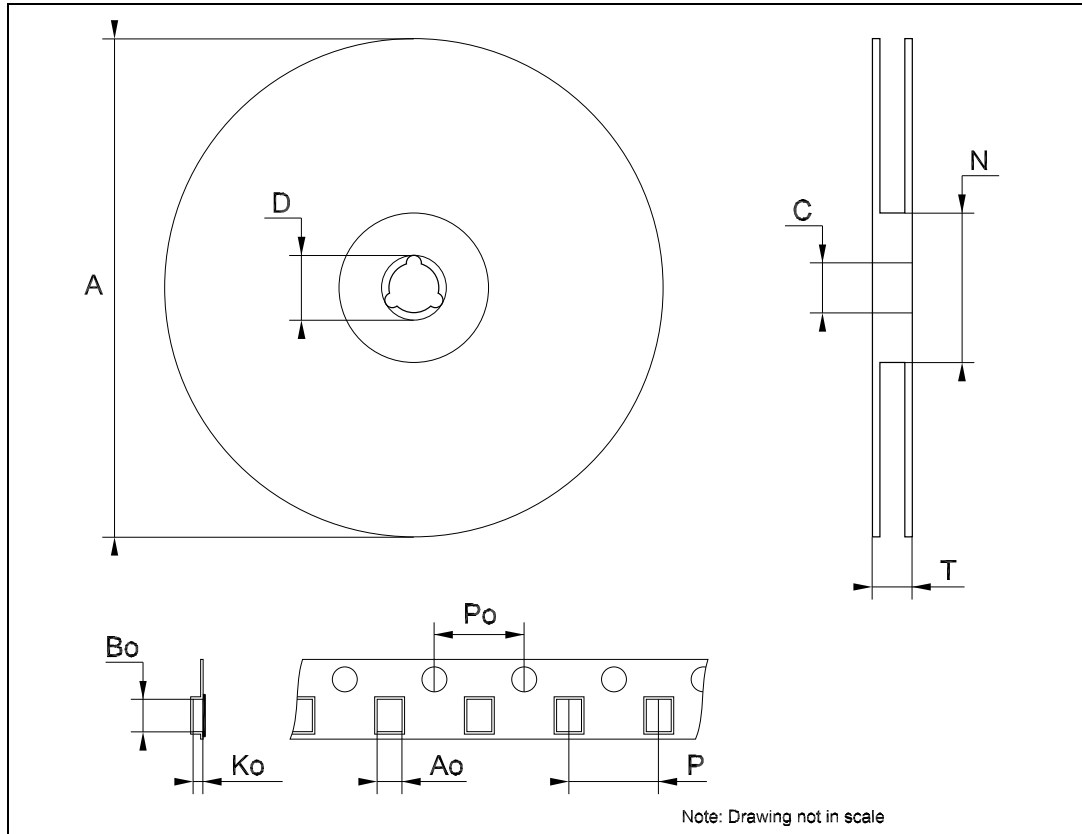

Table 9. Flip-chip 5 tape and reel mechanical data

Dim.	mm		
	Min.	Typ.	Max.
A			178
C	12.8		13.2
D	20.2		
N	49	50	51
T			12.4
Ao	1.60	1.65	1.70
Bo	1.27	1.32	1.37
Ko	0.76	0.81	0.86
Po	3.9	4	4.1
P	3.9	4	4.1

Table 10. SOT23-5L tape and reel mechanical data

Dim.	mm		
	Min.	Typ.	Max.
A			180
C	12.8	13.0	13.2
D	20.2		
N	60		
T			14.4
Ao	3.13	3.23	3.33
Bo	3.07	3.17	3.27
Ko	1.27	1.37	1.47
Po	3.9	4.0	4.1
P	3.9	4.0	4.1

Table 11. TSOT23-5L tape and reel mechanical data

Dim.	mm		
	Min.	Typ.	Max.
A			180
C	12.8	13.0	13.2
D	20.2		
N	60		
T			14.4
Ao	3.13	3.23	3.33
Bo	3.07	3.17	3.27
Ko	1.27	1.37	1.47
Po	3.9	4.0	4.1
P	3.9	4.0	4.1

## 9 Order codes

Table 12. Order codes

Packages			
SOT23-5L	TSOT23-5L	Flip-chip	Output voltage
LD3985M122R	LD3985G122R <sup>(1)</sup>		1.22 V
LD3985M18R	LD3985G18R	LD3985J18R	1.8 V
LD3985M25R	LD3985G25R	LD3985J25R	2.5 V
		LD3985J26R	2.6 V
LD3985M27R	LD3985G27R		2.7 V
LD3985M28R	LD3985G28R	LD3985J28R	2.8 V
LD3985M29R		LD3985J29R	2.9 V
LD3985M30R	LD3985G30R	LD3985J30R	3.0 V
LD3985M33R	LD3985G33R	LD3985J33R	3.3 V
LD3985M47R	LD3985G47R		4.7 V

1. Available on request.

## 10 Revision history

**Table 13. Document revision history**

Date	Revision	Changes
07-May-2004	6	Part number status changed on table 3.
05-Oct-2004	7	$t_{ON}$ values are changed on table 5.
27-Oct-2004	8	Order codes changed - table 3.
17-Mar-2005	9	Improved drawing quality for figures 19 - 20 - 21 - 22.
10-Apr-2007	10	Order codes updated.
08-Jun-2007	11	Order code change.
20-Dec-2007	12	Modified: <a href="#">Table 1</a> , <a href="#">Table 12</a> , mechanical data for Flip-chip.
02-Dec-2008	13	Modified: <a href="#">Table 6 on page 14</a> and <a href="#">Figure 23 on page 17</a> .
03-Jan-2011	14	Modified: <a href="#">Features on page 1</a> and <a href="#">Table 12 on page 20</a> .
08-Jan-2014	15	Part number LD3985XX changed to LD3985. Modified title in cover page. Updated the description and <a href="#">Section 7: Package mechanical data</a> . Added <a href="#">Section 8: Packaging mechanical data</a> . Minor text changes.

**Please Read Carefully:**

Information in this document is provided solely in connection with ST products. STMicroelectronics NV and its subsidiaries ("ST") reserve the right to make changes, corrections, modifications or improvements, to this document, and the products and services described herein at any time, without notice.

All ST products are sold pursuant to ST's terms and conditions of sale.

Purchasers are solely responsible for the choice, selection and use of the ST products and services described herein, and ST assumes no liability whatsoever relating to the choice, selection or use of the ST products and services described herein.

No license, express or implied, by estoppel or otherwise, to any intellectual property rights is granted under this document. If any part of this document refers to any third party products or services it shall not be deemed a license grant by ST for the use of such third party products or services, or any intellectual property contained therein or considered as a warranty covering the use in any manner whatsoever of such third party products or services or any intellectual property contained therein.

**UNLESS OTHERWISE SET FORTH IN ST'S TERMS AND CONDITIONS OF SALE ST DISCLAIMS ANY EXPRESS OR IMPLIED WARRANTY WITH RESPECT TO THE USE AND/OR SALE OF ST PRODUCTS INCLUDING WITHOUT LIMITATION IMPLIED WARRANTIES OF MERCHANTABILITY, FITNESS FOR A PARTICULAR PURPOSE (AND THEIR EQUIVALENTS UNDER THE LAWS OF ANY JURISDICTION), OR INFRINGEMENT OF ANY PATENT, COPYRIGHT OR OTHER INTELLECTUAL PROPERTY RIGHT.**

**ST PRODUCTS ARE NOT DESIGNED OR AUTHORIZED FOR USE IN: (A) SAFETY CRITICAL APPLICATIONS SUCH AS LIFE SUPPORTING, ACTIVE IMPLANTED DEVICES OR SYSTEMS WITH PRODUCT FUNCTIONAL SAFETY REQUIREMENTS; (B) AERONAUTIC APPLICATIONS; (C) AUTOMOTIVE APPLICATIONS OR ENVIRONMENTS, AND/OR (D) AEROSPACE APPLICATIONS OR ENVIRONMENTS. WHERE ST PRODUCTS ARE NOT DESIGNED FOR SUCH USE, THE PURCHASER SHALL USE PRODUCTS AT PURCHASER'S SOLE RISK, EVEN IF ST HAS BEEN INFORMED IN WRITING OF SUCH USAGE, UNLESS A PRODUCT IS EXPRESSLY DESIGNATED BY ST AS BEING INTENDED FOR "AUTOMOTIVE, AUTOMOTIVE SAFETY OR MEDICAL" INDUSTRY DOMAINS ACCORDING TO ST PRODUCT DESIGN SPECIFICATIONS. PRODUCTS FORMALLY ESCC, QML OR JAN QUALIFIED ARE DEEMED SUITABLE FOR USE IN AEROSPACE BY THE CORRESPONDING GOVERNMENTAL AGENCY.**

Resale of ST products with provisions different from the statements and/or technical features set forth in this document shall immediately void any warranty granted by ST for the ST product or service described herein and shall not create or extend in any manner whatsoever, any liability of ST.

ST and the ST logo are trademarks or registered trademarks of ST in various countries.

Information in this document supersedes and replaces all information previously supplied.

The ST logo is a registered trademark of STMicroelectronics. All other names are the property of their respective owners.

© 2014 STMicroelectronics - All rights reserved

STMicroelectronics group of companies

Australia - Belgium - Brazil - Canada - China - Czech Republic - Finland - France - Germany - Hong Kong - India - Israel - Italy - Japan - Malaysia - Malta - Morocco - Philippines - Singapore - Spain - Sweden - Switzerland - United Kingdom - United States of America

[www.st.com](http://www.st.com)