

TÜV Rheinland

# COMMAND SWITCHES

AR22•DR22/AR30•DR30  
AH164•AH165•AH165-2

16mm/22mm/30mm Diameter



## Preface

Fuji Electric manufactures FUJI COMMAND SWITCHES-pushbutton, illuminated pushbutton, and selector switches, and pilot lights.

FUJI COMMAND SWITCHES are used in machine tools, industrial machines, control panels, distribution panels, and instrumentation panels both in Japan and overseas.

COMMAND SWITCHES improve interfacing with better layout and wiring, easier installation, and increased safety.

Reliability is of course, built in to handle complex multifunctional control.

## Table of Contents

Page

	Command Series General Information.....	1
AR22 and DR22 series	General Information.....	2
	Quick Reference Guide.....	3
	Part Number System.....	7
	Ratings and Specifications.....	12
	Illuminated Pushbuttons.....	17
	Pushbuttons.....	20
	Emergency Stop Pushbuttons.....	23
	Emergency Stop Illuminated Pushbuttons.....	24
	Selector Switches.....	25
	Illuminated Selector Switches.....	32
	Pilot Lights.....	34
	Joy Stick Selector Switches.....	38
	Buzzers.....	39
	Dimensions.....	40
AR30 and DR30 series	Notes on Use.....	50
	General Information.....	55
	Quick Reference Guide.....	56
	Part Number System.....	60
	Ratings and Specifications.....	65
	Illuminated Pushbuttons.....	71
	Pushbuttons.....	73
	Emergency Stop Pushbuttons.....	76
	Emergency Stop Illuminated Pushbuttons.....	77
	Selector Switches.....	78
	Illuminated Selector Switches.....	85
	Pilot Lights.....	87
	Joy Stick Selector Switches.....	90
	Buzzers.....	91
Dimensions.....	92	
AH164, AH165 and AH165-2	Notes on Use.....	103
	Accessories.....	106
	Special Products.....	119
	Mass.....	122
	General Information.....	126
	Quick Reference Guide.....	127
	Part Number System (AH164, AH165).....	132
	Ratings and Specifications.....	134
	Illuminated Pushbuttons.....	136
	Pushbuttons.....	141
	Selector Switches.....	143
	Pilot Lights.....	148
	Buzzers.....	150
	Mounting Space.....	151
Terms and Conditions of Sale	Part Number System (AH165-2).....	152
	Ratings and Specifications.....	154
	Illuminated Pushbutton Switches.....	155
	Pushbutton Switches.....	158
	Selector Switches.....	160
	Pilot Lights.....	164
	Mounting Space.....	165
	Notes on Use (AH164, AH165 and AH165-2).....	166
	Accessories (AH164, AH165).....	169
	Accessories (AH165-2).....	171
	Accessories.....	173
	Mass.....	175
	AH-series Pushbutton Cross to AR-series Pushbutton.....	177
	Terms and Conditions of Sale.....	184

## ■ Command series

### AR22/DR22



AF94-320

- 22mm diameter hole
- Mountable even on panel cutout 25mm in diameter.
- Provided with newly developed release arm
- Provided with terminal cover for safety and security
- UL, CSA, TÜV and CCC approved



AF94-310



AF98-88

### AH164, 165



SK-1103

- 16mm diameter hole, finger-sized button
- Incandescent, neon and LED lamps are available.
- Block type contact
- AH165 series is oil-tight
- UL, CSA, TÜV and CCC approved



SK-1138

### AR30/DR30



AF95-4

- 30mm diameter hole
- Provided with terminal cover for safety and security
- UL, CSA, TÜV and CCC approved



AF95-6



AF98-195

### AH165-2



AF87-211

- 16mm diameter hole
- AH165-2 series are about twice as large as the AH165 series
- Incandescent, neon and LED lamps are available.
- Block type contact
- AH165-2 series is oil-tight
- UL, CSA, TÜV and CCC approved



AF87-208

# Pushbuttons/Selectors/Pilot Lights/Buzzers

## AR22 and DR22

### General information

The AR22 now uses a release arm with a wedge mechanism developed by Fuji Electric FA. This enables you to mount or remove the operator and contact block without using any tools. When fitting the switch to a panel, you can ignore the panel thickness. You have only to secure the operator with a locking nut from behind the panel without any need for adjustment. The improved locking nut is capable of mounting the operator in both 22.3mm and 25.5mm dia. panel cutout holes.

#### ■ Features

##### Facilitated mounting

- No adjusting of panel thickness is necessary.
- The button and lens can be mounted on a panel while the operator is engaged.
- Mountable even on a panel cutout 25.5mm in diameter.

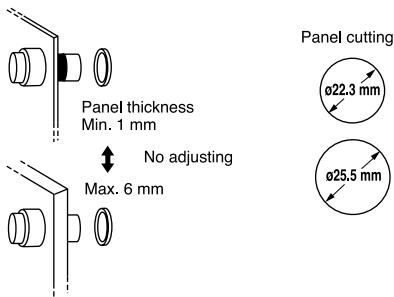

#### Miniaturization

- Pushbuttons and selector switches with 1NO+1NC: 41mm deep
- Pilot lights: 37mm deep
- The transformer now occupies far less space.

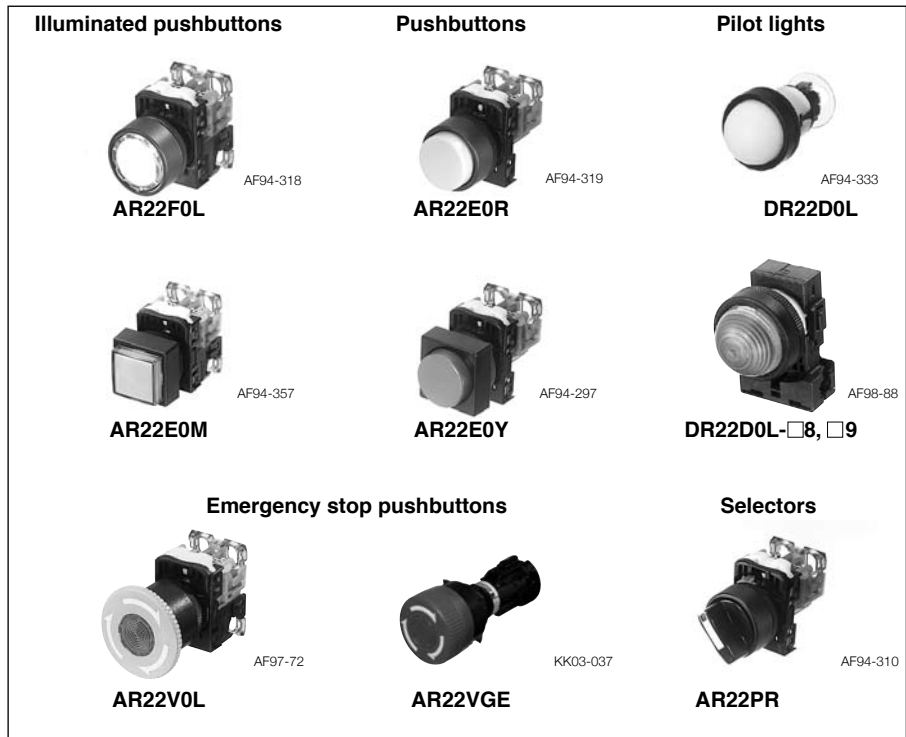
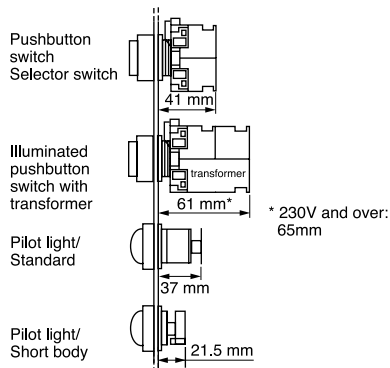

#### Easy replacing contact block and transformer

- Because of a snap-on mounting, replacement or addition of the contact block and transformer unit is very simple.
- The contact block is common to all the pushbuttons of this series.
- Contact block is easily replaced even when the pushbuttons are mounted closely together.
- Replacement of the contact block can be done with a screwdriver, without the need for any special tool.

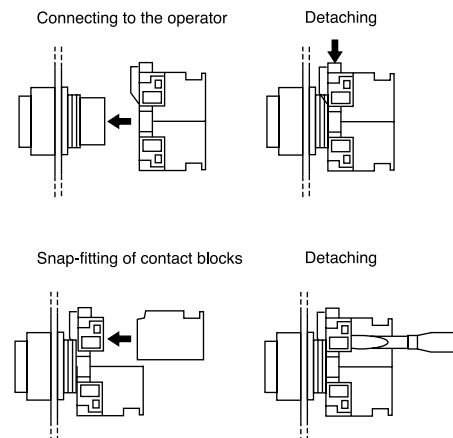

#### Wiring

- Wiring from two directions is possible.
- Wiring in both vertical and lateral directions facilitates wiring in narrow spaces.
- Color coding of contact blocks makes wiring easy.  
1NO: Blue, 1NC: Red  
Lamp terminal and transformer unit: Black

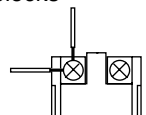

#### Safety

- A terminal cover is provided, assuring safety and security.
- FUJI's original Trigger Action mechanism is used in the emergency stop pushbuttons. They are suitable for emergency stop and safety. This mechanism prevents the contacts from moving until the button is pushed and locked.
- Reliability of safety functions increased by integrated operator and contact block construction. (AR22VG)

#### Protection

- Excellent oil-tight construction (IP65) of the operator.
- Closure of the contact block has been improved.

#### ■ Approvals



# Pushbuttons/Selectors/Pilot Lights/Buzzers







## AR22 and DR22

### Quick reference guide

#### ■ Illuminated pushbutton switches

Operator	Type	Operator	Type	Operator	Type
Flush round head	<b>AR22F0L, F5L</b>  AF94-318	Extended with full guard (24mm dia. with openings)	<b>AR22G2L, G7L</b>  AF99-319	Flush round head with square bezel	<b>AR22F0P, F5P</b>  AF94-315
Extended round head	<b>AR22E0L, E5L</b>  AF94-317	Extended with full guard (24mm dia.)	<b>AR22G1L, G6L</b>  AF02-70	Extended round head with square bezel	<b>AR22E0P, E5P</b>  AF94-314
Mushroom head (40mm dia.)	<b>AR22M0L, M5L</b>  AF94-367	Push-lock, turn-reset (40mm dia. with white arrow)	<b>AR22V5L</b>  AF97-72	Mushroom head with square bezel (29mm dia.)	<b>AR22M4P</b>  AF94-440
Mushroom head (29mm dia.)	<b>AR22M4L, M9L</b>  AF94-369	Flush square head	<b>AR22F0M, F5M</b>  AF97-68		
Extended with transparent full guard (24mm dia.)	<b>AR22G4L, G9L</b>  AF94-294	Extended square head	<b>AR22E0M, E5M</b>  AF94-357		

#### ■ Pushbutton switches

Operator	Type	Operator	Type	Operator	Type
Flush round head	<b>AR22F0R, F5R</b>  AF94-320	Flush round head Symbol mark type	<b>AR22FAR, FBR</b>  AF98-193	Mushroom head (40mm dia.)	<b>AR22M0R, M5R</b>  AF94-293
Extended round head	<b>AR22E0R, E5R</b>  AF94-319	Extended round head Symbol mark type	<b>AR22EAR, EBR</b>  AF98-192	Mushroom head (29mm dia.)	<b>AR22M4R, M9R</b>  AF94-321

# Pushbuttons/Selectors/Pilot Lights/Buzzers

## AR22 and DR22



### Quick reference guide

#### ■ Pushbutton switches

Operator	Type	Operator	Type	Operator	Type
Extended with full guard (24mm dia.)	<b>AR22G3R, G8R</b>  AF94-292	Pushbutton with selector ring (2-position)	<b>AR22S1R, S2R, S3R, S6R</b>  AF97-507	Flush round head with square bezel	<b>AR22F0Y, F5Y</b>  AF94-295
Flush with full guard (24mm dia.)	<b>AR22G2R, G7R</b>  AF02-68	Push-lock, turn-reset (40mm dia. with white arrow)	<b>AR22V5R</b>  AF97-70	Extended round head with square bezel	<b>AR22E0Y, E5Y</b>  AF94-297
Extended with half guard	<b>AR22G0R, G5R</b>  AF96-236	Flush square head	<b>AR22F0S, F5S</b>  AF94-316	Mushroom head with square bezel (29mm dia.)	<b>AR22M4Y</b>  AF94-298
Mushroom head with full guard (40mm dia.)	<b>AR22M3R, M8R</b>  AF94-372	Extended square head	<b>AR22E0S, E5S</b>  AF94-296		

Note: AR22M8R: Not approved standard

#### ■ Emergency stop pushbutton switches (conform to EN418)

Operator	Type	Operator	Type	Operator	Type
Push-lock, turn-reset (Soft-touch 40mm dia. with white arrow)	<b>AR22V0R</b>  AF97-70	Push-lock, turn-reset (29mm dia.)	<b>AR22V4R</b>  AF95-53	Unibody push-lock, turn-reset (Soft-touch 40mm dia. with white arrow)	<b>AR22VGE</b>  KK03-037
Push-lock, turn-reset (40mm dia.)	<b>AR22V2R</b>  AF94-432	Key release push-lock, turn-reset (40mm dia.)	<b>AR22V7R</b>  AF98-37		
Push-lock, turn-reset (Soft-touch 29mm dia. with white arrow)	<b>AR22VSR</b>  AF99-317	Push-lock, pull-reset (35mm dia.)	<b>AR22Q2R</b>  AF95-52		













Notes: Provided with the  (Direct opening action)

# Pushbuttons/Selectors/Pilot Lights/Buzzers

## AR22 and DR22

### Quick reference guide

#### ■ Emergency stop illuminated pushbutton switches (conform to EN418)





Operator	Type	Operator	Type	Operator	Type
Push-lock, turn-reset (Soft-touch 40mm dia. with white arrow)	<b>AR22V0L</b>  AF97-72	Push-lock, turn-reset (Soft-touch 40mm dia. transparent in all colors with white arrow)	<b>AR22VDL</b>  AF97-77	Push-lock, turn-reset (Soft touch 29mm dia. with white arrow)	<b>AR22VSL</b>  AF99-316
					
Push-lock, turn-reset (40mm dia.)	<b>AR22V2L</b>  AF94-307	Push-lock, turn-reset (40mm dia. transparent in all colors)	<b>AR22VAL</b>  AF94-365	Unibody push-lock, turn-reset (Soft-touch 40mm dia. with white arrow)	<b>AR22VGF</b>  KK03-036
					

Note: Provided with the  (Direct opening action)

#### ■ Selector switches

Operator	Type	Operator	Type	Operator	Type
Knob	<b>AR22PR, PCR</b>  AF94-310	Key	<b>AR22JR, JCR</b>  AF94-311	Lever with square bezel	<b>AR22WY, WCY</b>  AF94-323
					
Lever	<b>AR22WR, WCR</b>  AF94-324	Key (Long durability)	<b>AR22JAR</b>  AF94-311	Cylindrical knob with square bezel	<b>AR22RY, RCY</b>  AF94-362
					
Cylindrical knob	<b>AR22RR, RCR</b>  AF94-308	Knob with square bezel	<b>AR22PY, PCY</b>  AF94-309	Key with square bezel	<b>AR22JY, JCY</b>  AF94-322
					

#### ■ Illuminated selector switches

Operator	Type	Operator	Type
Knob	<b>AR22PL</b>  AF94-306	Knob with square bezel	<b>AR22PP</b>  AF94-318
			

# Pushbuttons/Selectors/Pilot Lights/Buzzers

## AR22 and DR22



### Quick reference guide

#### ■ Pilot lights



Lens	Type	Lens	Type	Lens	Type
Dome	<b>DR22D0L</b>  AF94-333	Flush square	<b>DR22F3M</b>  AF94-330	Extended square	<b>DR22E3M</b>  AF94-380
Extended round	<b>DR22E3L</b>  AF94-332	Flush square (Transparent lens)	<b>DR22F4M</b>  AF94-443	Flush rectangular	<b>DR22E3N</b>  AF96-237
Faceted	<b>DR22K0L</b>  AF96-189	Flush square (12mm high frame)	<b>DR22F5M</b>  AF95-658	Extended round with square bezel	<b>DR22E3P</b>  AF94-331

Note: With resistor unit type: Not approved standard

#### ■ Joy stick selector switches



Handle	Type	Handle	Type	Handle	Type
Ball type	<b>AR22A0, A5</b>  AF97-49	Ball type with lock	<b>AR22A1, A6</b>  AF97-45	Rubber cap type	<b>AR22A2, A7</b>  AF97-56

#### ■ Buzzers

Sound	Type	Sound	Type	Sound	Type
Electronic sound	<b>DR22B5 *</b>  AF96-377	Magnetic sound	<b>DR22B3</b>  AF96-376	Electronic sound (IP54)	<b>DR22B8 *</b>  AF96-244

Note: \* 6V AC, 110V DC types: Not approved standard

#### ■ Numerical indicators

Display	Type	Display	Type
One-digit	<b>DR22N1</b>  KK02-548	Two-digit	<b>DR22N2</b>  KK02-16B



# Pushbuttons/Selectors/Pilot Lights/Buzzers

## AR22 and DR22

### Part number system

#### Illuminated pushbuttons

#### AR22 E0L – 10 E3 R

①    ②    ③    ④    ⑤    ⑥

##### ① Product category

AR22: 22mm-dia. illuminated pushbutton  
 22mm-dia. emergency stop illuminated pushbutton

##### ② Operator

- Illuminated pushbutton
- F0L: Flush round head
- F5L: Flush round head (Alternate)
- E0L: Extended round head
- E5L: Extended round head (Alternate)
- M0L: Mushroom head (40mm dia.)
- M5L: Mushroom head (40mm dia. alternate)
- M4L: Mushroom head (29mm dia.)
- M9L: Mushroom head (29mm dia. alternate)
- G4L: Extended with transparent full guard (24mm dia.)
- G9L: Extended with transparent full guard (24mm dia. alternate)
- G2L: Extended with full guard (24mm dia. with openings)
- G7L: Extended with full guard (24mm dia. with openings, alternate)
- G1L: Extended with full guard (24mm dia.)
- G6L: Extended with full guard (24mm dia. alternate)
- V5L: Push-lock, turn-reset (40mm dia. with white arrow) \*1
- F0M: Flush square head
- F5M: Flush square head (Alternate)
- E0M: Extended square head
- E5M: Extended square head (Alternate)
- F0P: Flush round head with square bezel
- F5P: Flush round head with square bezel (Alternate)
- E0P: Extended round head with square bezel
- E5P: Extended round head with square bezel (Alternate)
- M4P: Mushroom head with square bezel (29mm dia.)
- Emergency stop illuminated pushbutton
- V0L: Push-lock, turn-reset (Soft-touch 40mm dia. with white arrow)
- V2L: Push-lock, turn-reset (40mm dia.)
- VDL: Push-lock, turn-reset (Soft-touch 40mm dia. transparent in all colors with white arrow)
- VAL: Push-lock, turn-reset (40mm dia. transparent in all colors)
- VSL: Push-lock, turn-reset (Soft-touch 29mm dia. with white arrow)
- VGf: Unibody push-lock, turn-reset (Soft-touch 40mm dia. with white arrow)

##### ③ Contact arrangement

10: 1NO	30: 3NO
01: 1NC	03: 3NC
11: 1NO+1NC	40: 4NO
20: 2NO	04: 4NC
02: 2NC	50: 5NO
22: 2NO+2NC	05: 5NC

##### ④ Lamp voltage

- Incandescent lamp
- 54: 5.5V AC/DC, without transformer
- C4: 15V AC/DC, without transformer
- D4: 20V AC/DC, without transformer
- E4: 24V AC/DC, without transformer
- H4: 100-110V AC, with transformer
- L4: 115-127V AC, with transformer
- M4: 200-220V AC, with transformer
- Q4: 230-254V AC, with transformer
- S4: 350-380V AC, with transformer
- T4: 400-440V AC, with transformer
- V4: 480V AC, with transformer
- W4: 500-550V AC, with transformer
- LED lamp
- A3: 6V AC, without transformer
- 63: 6V DC, without transformer
- B3: 12V AC/DC, without transformer
- C3: 15V AC/DC, without transformer
- E3: 24V AC/DC, without transformer
- H3: 100-110V AC, with transformer
- L3: 115-127V AC, with transformer
- M3: 200-220V AC, with transformer
- Q3: 230-254V AC, with transformer
- S3: 350-380V AC, with transformer
- T3: 400-440V AC, with transformer
- V3: 480V AC, with transformer
- W3: 500-550V AC, with transformer

- Neon lamp (For AR22VGF)
- H1: 110V AC, without transformer
- K1: 120V AC, without transformer
- M1: 220V AC, without transformer
- P1: 240V AC, without transformer

##### ⑤ Color of lens

G: Green	Y: Yellow
R: Red *2	A: Orange
W: White	S: Blue

##### ⑥ Special product

- Z9: Resisting water-soluble cutting oils and heat
- Z8: With a contact protection cover
- Z4: Resisting sulfuration gas
- ZB: Meeting IP2X finger-protection standards

Notes: \*1 Products with no trigger action mechanism. These products cannot be used as emergency stop switches that comply with EN standards.

\*2 Button color of emergency stop illuminated switches are Red only.

• The manufacturing range varies depending on the model. For details, refer to the contents of this catalog.

# Pushbuttons/Selectors/Pilot Lights/Buzzers

## AR22 and DR22

### Part number system

#### Pushbuttons

**AR22 E0R – 10 R**

① ② ③ ④ ⑤ ⑥

#### ① Product category

AR22: 22mm-dia. pushbutton  
22mm-dia. emergency stop pushbutton

#### ② Operator

- Pushbutton switch
- F0R: Flush round head
- F5R: Flush round head (Alternate)
- E0R: Extended round head
- E5R: Extended round head (Alternate)
- FAR: Flush round head (Symbol mark type)
- FBR: Flush round head (Symbol mark type, alternate)
- EAR: Extended round head (Symbol mark type)
- EBR: Extended round head (Symbol mark type, alternate)
- M0R: Mushroom head (40mm dia.)
- M5R: Mushroom head (40mm dia. Alternate)
- M4R: Mushroom head (29mm dia.)
- M9R: Mushroom head (29mm dia. Alternate)
- G3R: Extended with full guard (24mm dia.)
- G8R: Extended with full guard (24mm dia. Alternate)
- G2R: Flush with full guard (24mm dia.)
- G7R: Flush with full guard (24mm dia. Alternate)
- G0R: Extended with half guard
- G5R: Extended with half guard (Alternate)
- M3R: Mushroom head with full guard (40mm dia.)
- M8R: Mushroom head with full guard (40mm dia. Alternate)
- S1R: Push-button with selector ring (2-position)
- S2R: Push-button with selector ring (2-position)
- S3R: Push-button with selector ring (2-position)
- S6R: Push-button with selector ring (2-position)
- V5R: Push-lock, turn-reset (40mm dia. with white arrow) \*1
- F0S: Flush square head
- F5S: Flush square head (Alternate)
- E0S: Extended square head
- E5S: Extended square head (Alternate)
- F0Y: Flush round head with square bezel
- F5Y: Flush round head with square bezel (Alternate)
- E0Y: Extended round head with square bezel
- E5Y: Extended round head with square bezel (Alternate)
- M4Y: Mushroom head with square bezel (29mm dia.)
- Emergency stop pushbutton switch
- V0R: Push-lock, turn-reset (Soft-touch 40mm dia. with white arrow)
- V2R: Push-lock, turn-reset (40mm dia.)
- VSR: Push-lock, turn-reset (Soft-touch 29mm dia. with white arrow)
- V4R: Push-lock, turn-reset (29mm dia.)
- V7R: Key-release push-lock, turn-reset (40mm dia.)
- Q2R: Push-lock, pull-reset (35mm dia.)
- VGE: Unibody push-lock, turn-reset (Soft-touch 40mm dia. with white arrow)

#### ③ Contact arrangement

10: 1NO	30: 3NO
01: 1NC	03: 3NC
11: 1NO+1NC	33: 3NO+3NC
20: 2NO	40: 4NO
02: 2NC	04: 4NC
22: 2NO+2NC	50: 5NO
	05: 5NC

#### ④ Color of button

G: Green	Y: Yellow
R: Red <sup>2</sup>	A: Orange
B: Black	S: Blue
W: White	C: Clear
T: Green, Red, Black (For AR22F0R)	(For AR22FAR, FBR, EAR, EBR)

#### ⑤ Symbol mark (For AR22FAR, FBR, EAR, EBR)

Symbol mark	○	I	⓪	Ⓛ	Ⓜ	Ⓝ
Color of button	White	Black	White	Black	White	Black
Color of mark	Red		Green		Green	Black
Code	01	02	03	04	11	12
					02B	04B 12B

#### ⑥ Special product

Z9: Resisting water-soluble cutting oils and heat  
Z8: With a contact protection cover  
Z4: Resisting sulfuration gas  
ZB: Meeting IP2X finger-protection standards

Notes: \*1 Products with no trigger action mechanism. These products cannot be used as emergency stop switches that comply with EN standards.

\*2 Button color of emergency stop switches are Red only.

• The manufacturing range varies depending on the model. For details, refer to the contents of this catalog.

**Selector and illuminated selector switches**

**AR22 PL – 2** □ **10 E3 G** □ □

① ② ③ ④ ⑤ ⑥ ⑦ ⑧ ⑨

**① Product category**

AR22: 22mm dia. selector switch and illuminated selector switch

**② Operator**

- Selector switch
- PR: Knob
- PCR: Knob operated control type
- WR: Lever
- WCR: Lever operated control type
- RR: Cylindrical knob
- RCR: Cylindrical knob operated control type
- JR: Key
- JCR: Key operated control type
- JAR: Key (Long durability)
- PY: Knob with square bezel
- PCY: Knob operated control type with square bezel
- WY: Lever with square bezel
- WCY: Lever operated control type with square bezel
- RY: Cylindrical knob with square bezel
- RCY: Cylindrical knob operated control type with square bezel
- JY:Key with square bezel
- JCY: Key operated control type with square bezel
- Illuminated selector switch
- PL: Knob
- PP: Knob with square bezel

**③ Operation**

- 2: 2-position, maintained
- 0: 2-position, spring return
- 3: 3-position, maintained
- 6: 3-position, spring/manual return (Left to center)
- 7: 3-position, spring/manual return (Right to center)
- 1: 3-position, spring return
- 4: 4-position, maintained (For AR22PCR, WCR, RCR)
- 5: 5-position, maintained (For AR22PCR, WCR, RCR)

**④ Key removable position**

- A: Left
- B: Left and right
- C: Left, right and center
- D: Right
- E: Center
- F: Right and center
- G: Left and center

**⑤ Contact arrangement**

- |             |             |
|-------------|-------------|
| 10: 1NO     | 30: 3NO     |
| 01: 1NC     | 03: 3NC     |
| 11: 1NO+1NC | 33: 3NO+3NC |
| 20: 2NO     | 40: 4NO     |
| 02: 2NC     | 04: 4NC     |
| 22: 2NO+2NC | 50: 5NO     |
|             | 05: 5NC     |

**⑥ Lamp voltage**

- Incandescent lamp
- 54: 5.5V AC/DC, without transformer
- C4: 15V AC/DC, without transformer
- D4: 20V AC/DC, without transformer
- E4: 24V AC/DC, without transformer
- H4: 100-110V AC, with transformer
- L4: 115-127V AC, with transformer
- M4: 200-220V AC, with transformer
- Q4: 230-254V AC, with transformer
- S4: 350-380V AC, with transformer
- T4: 400-440V AC, with transformer
- V4: 480V AC, with transformer
- W4: 500-550V AC, with transformer
- LED lamp
- A3: 6V AC, without transformer
- 63: 6V DC, without transformer
- B3: 12V AC/DC, without transformer
- C3: 15V AC/DC, without transformer
- E3: 24V AC/DC, without transformer
- H3: 100-110V AC, with transformer
- L3: 115-127V AC, with transformer
- M3: 200-220V AC, with transformer
- Q3: 230-254V AC, with transformer
- S3: 350-380V AC, with transformer
- T3: 400-440V AC, with transformer
- V3: 480V AC, with transformer
- W3: 500-550V AC, with transformer

**⑦ Color of knob**

- B: Black (Not available for illuminated selector switch)
- G: Green
- R: Red
- W: White (Not available for selector switch)
- Y: Yellow (Not available for selector switch)
- A: Orange (Not available for selector switch)
- S: Blue (Not available for selector switch)

**⑧ Key type No.**

A, B, C, D, E or F  
 ("A" is standard)

**⑨ Special product**

- Z9: Resisting water-soluble cutting oils and heat
- Z8: With a contact protection cover
- Z4: Resisting sulfuration gas
- ZB: Meeting IP2X finger-protection standards

Note: • The manufacturing range varies depending on the model. For details, refer to the contents of this catalog.

# Pushbuttons/Selectors/Pilot Lights/Buzzers

## AR22 and DR22

### Part number system

#### Pilot lights

#### **DR22 D0L – E3 W** □

① ② ③ ④ ⑤

##### ① Product category

DR22: 22mm dia. pilot light

##### ② Lens

D0L: Dome

E3L: Extended round

K0L: Faceted

F3M: Flush square

F4M: Flush square (Transparent lens)

F5M: Flush square (12mm high frame)

E3M: Extended square

E3N: Flush rectangular

E3P: Extended round with square bezel

##### ③ Lamp voltage

•Incandescent lamp

54: 5.5V AC/DC, without transformer

C4: 15V AC/DC, without transformer

D4: 20V AC/DC, without transformer

E4: 24V AC/DC, without transformer

H4: 100-110V AC, with transformer

L4: 115-127V AC, with transformer

M4: 200-220V AC, with transformer

Q4: 230-254V AC, with transformer

S4: 350-380V AC, with transformer

T4: 400-440V AC, with transformer

V4: 480V AC, with transformer

W4: 500-550V AC, with transformer

•LED lamp

A3: 6V AC, without transformer

63: 6V DC, without transformer

B3: 12V AC/DC, without transformer

C3: 15V AC/DC, without transformer

E3: 24V AC/DC, without transformer

H3: 100-110V AC, with transformer

L3: 115-127V AC, with transformer

M3: 200-220V AC, with transformer

Q3: 230-254V AC, with transformer

S3: 350-380V AC, with transformer

T3: 400-440V AC, with transformer

V3: 480V AC, with transformer

W3: 500-550V AC, with transformer

H7: 110V DC, with resistor unit

58: 5.5V AC/DC, short-body without transformer

C8: 15V AC/DC, short-body without transformer

D8: 20V AC/DC, short-body without transformer

E8: 24V AC/DC, short-body without transformer

H8: 100-110V AC, short-body with transformer

L8: 115-127V AC, short-body with transformer

M8: 200-220V AC, short-body with transformer

A9: 6V AC, short-body without transformer

69: 6V DC, short-body without transformer

B9: 12V AC/DC, short-body without transformer

C9: 15V AC/DC, short-body without transformer

E9: 24V AC/DC, short-body without transformer

H9: 100-110V AC, short-body with transformer

L9: 115-127V AC, short-body with transformer

M9: 200-220V AC, short-body with transformer

##### ④ Color of lens

G: Green

Y: Yellow

R: Red

A: Orange

W: White

S: Blue

##### ⑤ Special product

Z9: Resisting water-soluble cutting oils and heat

Z4: Resisting sulfuration gas

ZB: Meeting IP2X finger-protection standards

Note: • The manufacturing range varies depending on the model. For details, refer to the contents of this catalog.

**Joy stick selector switches**

**AR22A 0 N – A0A0 B**

① ②③ ④ ⑤

① **Product category**

AR22A: 22mm-dia. Joy stick selector switch

② **Handle**

- 0: Ball type (without lock, manual return)
- 1: Ball type with lock (manual return)
- 2: Rubber cap type (without lock, manual return)
- 5: Ball type (without lock, spring return)
- 6: Ball type with lock (spring return)
- 7: Rubber cap type (without lock, spring return)

③ **Terminal**

- N: Screw
- H: Solder/tab

④ **Contact arrangement**

Contact arrangement	Blank	1NO	1NC	1NO+1NC	2NO	2NC	2NO+2NC
Code	Screw	0	A	B	1	D	E
	Solder/tab	0	-	-	1	-	2

Operating direction code of contacts

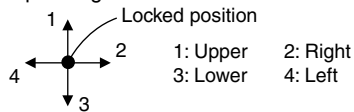

Ex. AR22A0N-A0A0B  
 1 2 3 4

⑤ **Handle color**

- B: Black

■ **Ordering information**

Specify the following:

1. Type number

For the CCC approved product, add the suffix **(CCC)** to the type number

Example: Pushbutton switch **AR22F0R-11B(CCC)**

**Buzzers**

**DR22B 5 – E B**

① ② ③ ④

① **Product category**

DR22B: 22mm-dia. buzzer

② **Sound**

- 5: Electronic sound
- 3: Magnetic sound
- 8: Electronic sound (IP54)

③ **Operating voltage**

- A: 6V AC (Type “5”, “8”)
- 6: 6V DC (Type “5”, “8”)
- E: 12-24V AC/DC (Type “3” : 24V AC/DC)
- F: 35-48V AC/DC (Type “5”, “8”)
- H: 100-110V AC
- M: 200-220V AC
- 1: 100-110V DC (Type “5”, “8”)

④ **Color of head**

- B: Black

# Pushbuttons/Selectors/Pilot Lights/Buzzers

## AR22 and DR22

### Ratings and specifications

#### ■ Standards approved

UL508	File No. E44592
CSA C22.2 No.14	File No. LR20479 cUL File No. E44592 (For AR22VG)
TÜV: EN60947-5-1	Pushbutton, Illuminated pushbutton: R9551062, Selector, Illuminated selector: R9551060 Pilot lights: R9551061 Joy stick selector switch: R2050803 (Lever switch) Buzzer: J9950091
TÜV: EN60947-5-1	Emergency stop pushbutton
EN60947-5-5	Emergency stop illuminated pushbutton : R50028146, R50028137 (For AR22VG)

#### ■ Specifications (Indoor use)

Description	Pushbutton switch Illuminated pushbutton switch Emergency stop pushbutton switch Emergency stop illuminated pushbutton switch Selector switch Illuminated selector switch	Joy stick selector (Lever switch)	Pilot light
Rated insulation voltage	600V AC/DC *1	250V AC/DC	250V AC/DC *2
Mechanical durability	See page 13	250,000 operations	–
Electrical durability	500,000 operations at 220V AC 6A 1 million operations at 220V AC 3A (AR22VG type: 100,000 operations)	100,000 operations at 220V AC 1A (Res. load)	–
Operating frequency	1200 operations/hour (On-load factor: 40%) AR22VG type: 1800 operations/hour (On-load factor: 40%)		–
Dielectric strength	2500V AC, 1 minute *3	2000V AC, 1 minute *4	
Insulation resistance	100MΩ or more (500V DC megger)		
Rated impulse dielectric strength	6kV (AR22VG type: 4kV)	–	6kV
Conditional short-circuit current	1000A	1000A	–
Short-circuit protective device	Fuse 15A	Fuse 1A	–
Pollution degree	3		
Vibration	Resonance: 10 to 55Hz, double amplitude 0.1mm *5 Constant: 16.7Hz, double amplitude 3mm		
Shock	Malfunction durability: 100m/s <sup>2</sup> *6 Mechanical durability: 500m/s <sup>2</sup>		Mechanical durability: 500m/s <sup>2</sup>
Ambient temperature (No condensation or no icing)	-20 to +70°C *7	-5 to +70°C	-20 to +50°C
Storage temperature	-40 to +80°C		
Humidity	45 to 85% RH (within -5 to +40°C)		
Degree of protection	IP65		

Notes: \*1 Illuminated type without transformer and AR22VG type: 250V AC/DC

\*2 Pilot light with transformer: 600V AC

\*3 Illuminated type without transformer: 2000V AC, 1 minute (except AR22VGF type)

\*4 Pilot light with transformer: 2500V AC, 1 minute

\*5 Emergency stop type: 10 to 500Hz, double amplitude 0.7mm (acceleration 50m/s<sup>2</sup>), according to the test condition of EN60947-5-5 (1998)

\*6 Emergency stop type: 150m/s<sup>2</sup>

\*7 AR22VGE type: -20 to +60°C, illuminated type: -20 to +50°C

# Pushbuttons/Selectors/Pilot Lights/Buzzers AR22 and DR22 Ratings and specifications

## ● Mechanical durability

Description		Operations
Pushbutton switch	Momentary action	5 million
Illuminated pushbutton switch	Alternate action	1 million
Emergency stop pushbutton switch	With selector ring	100,000
Emergency stop illuminated pushbutton	Push-lock, turn-reset	100,000
	Push-lock, pull-reset	30,000
Selector switch	Maintained 1, 2, 3, 4-contact	1 million
	Maintained 5, 6-contact	500,000
	Control type, spring return, spring/manual return	200,000
Illuminated selector switch	Maintained	
	Without transformer 1, 2, 3-contact	1 million
	4-contact	500,000
	With transformer 1, 2-contact	1 million
	3-contact	500,000
	Spring return, spring/manual return	200,000

Note: Key insertion/removal durability for selector switch key types

- Key type 10,000
- Key (Long durability) type 20,000

## ● Buzzers

Item	DR22B5	DR22B3	DR22B8
Rated insulation voltage	Without transformer: 60V AC/DC With transformer: 250V AC		
Sound level	90dB (0.1m) 70dB (1m)	80 to 90dB (0.1m) 60 to 70dB (1m)	80dB (0.1m) 60dB (1.0m)
Durability	1000h	200h	1000h
Frequency	2.4 to 3.3kHz		
Intermittent cycle	Approx. 170-cycle/min		
Current consumption	See the table below		
Dielectric strength	Without transformer: 1000V AC 1 minute With transformer: 2000V AC 1 minute		
Insulation resistance	100MΩ or more (500V DC megger)		
Pollution degree	3		
Vibration	Resonance: 10 to 55Hz, double amplitude 0.1mm Constant: 16.7Hz, double amplitude 3.0mm		
Shock	Mechanical durability: 500m/s <sup>2</sup>		
Ambient temperature	-20 to +60°C (No condensation or no icing) (with resistor unit: -20 to +40°C)		
Storage temperature	-30 to +70°C		
Humidity	45 to 85%RH (within -5 to 40°C)		
Degree of protection	IP00		IP54

## •Current consumption

Operational voltage	Current consumption	
	DR22B5, DR22B8	DR22B3
6V AC	70mA AC	—
6V DC	35mA DC	—
24V AC/DC	40mA AC, 25mA DC	30mA AC, 20mA DC
48V AC/DC	65mA AC, 20mA DC	—
110V AC	30mA AC	30mA AC
110V DC	30mA DC	—
220V AC	15mA AC	15mA AC

# Pushbuttons/Selectors/Pilot Lights/Buzzers

## AR22 and DR22

### Ratings and specifications

- Contact ratings
- UL/CSA standards
- AC (COS  $\phi=0.35$ )

Contact rated code	120V		240V		480V		600V	
	Making current	Breaking current	Making current	Breaking current	Making current	Breaking current	Making current	Breaking current
A600	60A	6.0A	30A	3.0A	15A	1.5A	12A	1.2A
B300 (AR22VG)	30A	3.0A	15A	1.5A	–	–	–	–

DC  $T_{0.95} = 6P$  (Max. 300ms)

Description	Contact rated code	Making current · Breaking current		
		125V	250V	301V–600V
Illuminated pushbutton switch Pushbutton (Ring type selector switch: AR22S2R only) Emergency stop pushbutton switch Emergency stop illuminated pushbutton switch (Except the overlap contact types)	P600	1.1A	0.55A	0.2A
	Q300 (AR22VG)	0.55A	0.27A	–
Overlap contact types of products shown above Pushbutton (Ring type selector switch: AR22S1R, S6R only) Selector switch (2-position only, except the overlap contact types) Illuminated selector switch (2-position only, except the overlap contact types)	Q600	0.55A	0.27A	0.1A
Pushbutton (Ring type selector switch: AR22S3R only) Selector switch (2-pos./overlap contact type, 3-, 4-, 5-pos. type) Illuminated selector switch (2-pos./overlap contact type, 3-pos. type)	R300	0.22A	0.11A	–

Note: Joy stick selector switches (Lever switches): 250V AC, 5A (Res. load) 125V DC, 0.2A 24V DC, 1A (Res. load)

#### ● EN standard/TÜV approved

Description	Rated operational current			
	Rated thermal current	Rated operational voltage	AC15 (Ind. load)	DC13 (Ind. load)
			Rated operational current	Rated operational current
Illuminated pushbutton switch Pushbutton (Except the selector ring type) Emergency stop pushbutton switch Emergency stop illuminated pushbutton switch Selector switch (2-position) Illuminated selector switch (2-position)	10A	24V	6.0A	4.0A (AR22VG: 1.5A)
		120V	6.0A (AR22VG: 3A)	–
		125V	–	1.3A (AR22VG: 0.3A)
		240V	6.0A (AR22VG: 3A)	–
		250V	–	0.45A (AR22VG: 0.15A)
		480V	2.5A (AR22VG: –)	–
		600V	2.0A (AR22VG: –)	–
Selector switch (3, 4, 5-position) Illuminated selector switch (3-position) Pushbutton with selector ring	10A	24V	6.0A	2.0A
		120V	6.0A	–
		125V	–	0.65A
		240V	6.0A	–
		250V	–	0.23A
		480V	2.5A	–
		600V	2.0A	–
Joy stick selector switch (Lever switch)	5A	24V	–	0.7A
		120V	0.3A	–
		125V	–	0.15A
		240V	0.3A	–

Lamp rated voltage UL/CSA standards, TÜV approved

	LED lamp	Incandescent lamp	Neon lamp
Full-voltage (without transformer)	Max. 24V AC/DC	Max. 30V AC/DC	Max. 240V AC
With transformer	Max. 550V AC (Short-body type: Max. 220V AC)		–



■ Operating characteristic (1NO+1NC)

Description	Pushbutton	Emergency stop pushbutton		Selector *2		
	Illuminated pushbutton	Emergency stop illuminated pushbutton		Illuminated selector		
		Push-lock type	Push-pull type	Maintained	Spring/manual return	Spring return
Ave. required operating force	9N (Push-lock type: 20N)	30N (AR22VG: 22N)*1	45N	0.15N•m	0.13N•m	0.1N•m
Operating travel	Approx. 6mm  (Push-lock type: Approx. 9mm, operation angle: Approx. 45°)	Approx. 9mm  (AR22VG: Approx. 10mm, operation angle: Approx. 45°)	Approx. 9mm	2-position: Approx. 90° 3-position: Approx. 45° 4-position: Approx. 40° 5-position: Approx. 30°	3-position: Approx. 45°	2-position: Approx. 60° 3-position: Approx. 45°
Required return force	– (Push-lock type: 0.6N•m)	0.6N•m (AR22VG: 0.2N•m)	30N (pull)	0.15N•m	0.13N•m	–

Notes: \*1 AR22V2R, V4R, V7R, VAL types: 45N

\*2 4-position, 5-position: 2NO+2NC

■ Lamp ratings

•Illuminated pushbuttons, illuminated selectors, pilot lights

Transformer	Lamp voltage	LED			Incandescent		
		Type	Rated voltage	Consumption	Type	Rated voltage	Consumption
Without transformer	5.5V AC/DC	–	–	–	AHX135	6.3V AC/DC	0.9W
	6V AC	APX510-6□	6V AC	Green, red, orange, amber: 7mA AC Yellow: 26mA AC Blue: 16mA AC	–	–	–
	6V DC	APX510-D6□	6V DC	Green, red, orange, amber: 11mA DC Yellow: 33mA DC Blue: 22mA DC	–	–	–
	12V AC/DC	APX510-12□	12V AC/DC	14mA AC, 11mA DC	–	–	–
	15V AC/DC	APX510-15□	15V AC/DC	13mA AC, 11mA DC	AHX279	18V AC/DC	0.8W
	20V AC/DC	–	–	–	AHX144	24V AC/DC	0.9W
With transformer (Standard type: AR9T511)	24V AC/DC	APX510-24□	24V AC/DC	12mA AC, 11mA DC	AHX129	30V AC/DC	0.8W
	110V AC	APX510-6□	6V AC	1.5VA	AHX135	6.3V AC/DC	2VA
	127V AC						2VA
	220V AC						2VA
	254V AC	APX510-6□	6V AC	2.5VA	AHX135	6.3V AC/DC	2.5VA
	380V AC						2.5VA
With resistor unit (AR9T519-H)	440V AC						2.5VA
	480V AC						2.5VA
	550V AC						2.5VA
	110V DC	APX510-24□	24V AC/DC	1.2W	–	–	–

Notes: • Short body pilot lights: 110V AC, 127V AC, 220V AC only

• Replace the □ mark by the lamp luminous color code, see page 16

• Except AR22VGF type

•Emergency stop illuminated pushbuttons (AR22VGF type)

Transformer	Lamp	Voltage	Type	Rated voltage	Consumption
Without transformer	LED	24V AC/DC	AR9L002-ER	24V AC/DC	12mA AC 11mA DC
		110V AC	AR9N001-HA	110V AC	0.19VA
	120V AC	AR9N001-KA	120V AC	0.21VA	
	220V AC	AR9N001-MA	220V AC	0.30VA	
	240V AC	AR9N001-PA	240V AC	0.30VA	

Notes: Lamp base: BA9S/13

# Pushbuttons/Selectors/Pilot Lights/Buzzers

## AR22 and DR22

### Ratings and specifications

#### ■ Lamp durability

Lamp	Durability	Judgement criterion
LED	Approx. 30000h	When brightness is less than 50% of initial value
Incandescent	Approx. 5000h (AC)	When the bulb burns out
Neon	Approx. 5000h	When a remarkable blackening appears in the glass bulb and the using becomes improper

Note: The operating voltage for incandescent lamps is set at 80 to 90% of the lamp's rated voltage.

#### Estimated durability for LED lamps

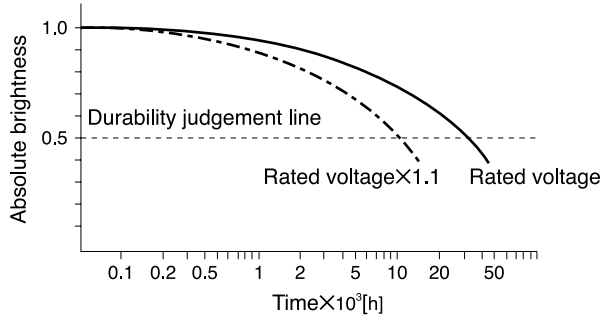

Notes: • Durability at  $T_a=25^{\circ}\text{C}$   
 • Durability is affected by temperature, humidity, and voltage fluctuation.

#### Incandescent lamp voltage characteristics

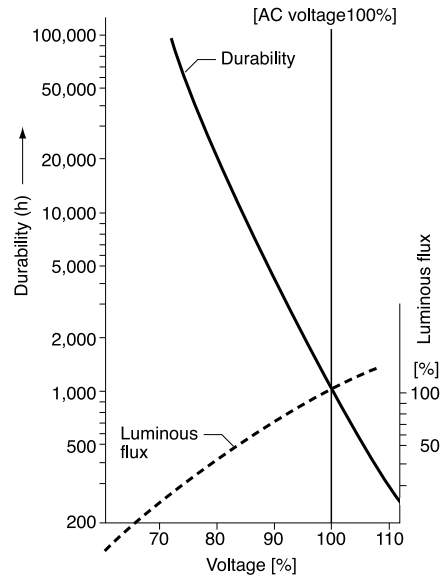







#### ■ Combination of lens color and LED or neon lamp luminous color

Lens Color	Code	LED or neon lamp	
		Luminous color	Type
Green	G	Green	APX510-■G
Red	R	Red	APX510-■R
White	W	Orange	APX510-■O
Yellow	Y	Yellow	APX510-■Y
Orange *	A	Amber	APX510-■A
Blue	S	Blue	APX510-■S
Red (AR22VGF)	R	Red	AR9L002-ER
		Orange (Neon lamp)	AR9N001-■A

Notes: \* DR22F4M: LED lamp color is orange. (APX510-■O)  
 • Replace the ■ mark by the lamp voltage code

## ■ Illuminated pushbutton switches

Operator	Transformer	Contact	LED lamp		Incandescent lamp	
			Momentary action Type	Alternate action Type	Momentary action Type	Alternate action Type
Flush round head  AF94-318	Without	1NO 1NC 1NO+1NC 2NO+2NC	AR22F0L-10■3 □ AR22F0L-01■3 □ AR22F0L-11■3 □ AR22F0L-22■3 □	AR22F5L-10■3 □ AR22F5L-01■3 □ AR22F5L-11■3 □ —	AR22F0L-10■4 □ AR22F0L-01■4 □ AR22F0L-11■4 □ AR22F0L-22■4 □	AR22F5L-10■4 □ AR22F5L-01■4 □ AR22F5L-11■4 □ —
	With	1NO 1NC 1NO+1NC	AR22F0L-10■3 □ AR22F0L-01■3 □ AR22F0L-11■3 □	AR22F5L-10■3 □ AR22F5L-01■3 □ AR22F5L-11■3 □	AR22F0L-10■4 □ AR22F0L-01■4 □ AR22F0L-11■4 □	AR22F5L-10■4 □ AR22F5L-01■4 □ AR22F5L-11■4 □
Extended round head  AF94-317	Without	1NO 1NC 1NO+1NC 2NO+2NC	AR22E0L-10■3 □ AR22E0L-01■3 □ AR22E0L-11■3 □ AR22E0L-22■3 □	AR22E5L-10■3 □ AR22E5L-01■3 □ AR22E5L-11■3 □ —	AR22E0L-10■4 □ AR22E0L-01■4 □ AR22E0L-11■4 □ AR22E0L-22■4 □	AR22E5L-10■4 □ AR22E5L-01■4 □ AR22E5L-11■4 □ —
	With	1NO 1NC 1NO+1NC	AR22E0L-10■3 □ AR22E0L-01■3 □ AR22E0L-11■3 □	AR22E5L-10■3 □ AR22E5L-01■3 □ AR22E5L-11■3 □	AR22E0L-10■4 □ AR22E0L-01■4 □ AR22E0L-11■4 □	AR22E5L-10■4 □ AR22E5L-01■4 □ AR22E5L-11■4 □
Mushroom head (40mm dia.)  AF94-367	Without	1NO 1NC 1NO+1NC 2NO+2NC	AR22M0L-10■3 □ AR22M0L-01■3 □ AR22M0L-11■3 □ AR22M0L-22■3 □	AR22M5L-10■3 □ AR22M5L-01■3 □ AR22M5L-11■3 □ —	AR22M0L-10■4 □ AR22M0L-01■4 □ AR22M0L-11■4 □ AR22M0L-22■4 □	AR22M5L-10■4 □ AR22M5L-01■4 □ AR22M5L-11■4 □ —
	With	1NO 1NC 1NO+1NC	AR22M0L-10■3 □ AR22M0L-01■3 □ AR22M0L-11■3 □	AR22M5L-10■3 □ AR22M5L-01■3 □ AR22M5L-11■3 □	AR22M0L-10■4 □ AR22M0L-01■4 □ AR22M0L-11■4 □	AR22M5L-10■4 □ AR22M5L-01■4 □ AR22M5L-11■4 □
Mushroom head (29mm dia.)  AF94-369	Without	1NO 1NC 1NO+1NC 2NO+2NC	AR22M4L-10■3 □ AR22M4L-01■3 □ AR22M4L-11■3 □ AR22M4L-22■3 □	AR22M9L-10■3 □ AR22M9L-01■3 □ AR22M9L-11■3 □ —	AR22M4L-10■4 □ AR22M4L-01■4 □ AR22M4L-11■4 □ AR22M4L-22■4 □	AR22M9L-10■4 □ AR22M9L-01■4 □ AR22M9L-11■4 □ —
	With	1NO 1NC 1NO+1NC	AR22M4L-10■3 □ AR22M4L-01■3 □ AR22M4L-11■3 □	AR22M9L-10■3 □ AR22M9L-01■3 □ AR22M9L-11■3 □	AR22M4L-10■4 □ AR22M4L-01■4 □ AR22M4L-11■4 □	AR22M9L-10■4 □ AR22M9L-01■4 □ AR22M9L-11■4 □
Extended with transparent full guard (24mm dia.)  AF94-294	Without	1NO 1NC 1NO+1NC 2NO+2NC	AR22G4L-10■3 □ AR22G4L-01■3 □ AR22G4L-11■3 □ AR22G4L-22■3 □	AR22G9L-10■3 □ AR22G9L-01■3 □ AR22G9L-11■3 □ —	AR22G4L-10■4 □ AR22G4L-01■4 □ AR22G4L-11■4 □ AR22G4L-22■4 □	AR22G9L-10■4 □ AR22G9L-01■4 □ AR22G9L-11■4 □ —
	With	1NO 1NC 1NO+1NC	AR22G4L-10■3 □ AR22G4L-01■3 □ AR22G4L-11■3 □	AR22G9L-10■3 □ AR22G9L-01■3 □ AR22G9L-11■3 □	AR22G4L-10■4 □ AR22G4L-01■4 □ AR22G4L-11■4 □	AR22G9L-10■4 □ AR22G9L-01■4 □ AR22G9L-11■4 □
Extended with full guard (24mm dia. with openings)  AF99-319	Without	1NO 1NC 1NO+1NC 2NO+2NC	AR22G2L-10■3 □ AR22G2L-01■3 □ AR22G2L-11■3 □ AR22G2L-22■3 □	AR22G7L-10■3 □ AR22G7L-01■3 □ AR22G7L-11■3 □ —	AR22G2L-10■4 □ AR22G2L-01■4 □ AR22G2L-11■4 □ AR22G2L-22■4 □	AR22G7L-10■4 □ AR22G7L-01■4 □ AR22G7L-11■4 □ —
	With	1NO 1NC 1NO+1NC	AR22G2L-10■3 □ AR22G2L-01■3 □ AR22G2L-11■3 □	AR22G7L-10■3 □ AR22G7L-01■3 □ AR22G7L-11■3 □	AR22G2L-10■4 □ AR22G2L-01■4 □ AR22G2L-11■4 □	AR22G7L-10■4 □ AR22G7L-01■4 □ AR22G7L-11■4 □

Note: ■ □ See page 19

# Illuminated Pushbuttons

## AR22

Operator	Transformer	Contact	LED lamp Momentary action Type	Alternate action Type	Incandescent lamp Momentary action Type	Alternate action Type
Extended with full guard (24mm dia.)  KK02-127A	Without	1NO 1NC 1NO+1NC 2NO+2NC	AR22G1L-10■3□ AR22G1L-01■3□ AR22G1L-11■3□ AR22G1L-22■3□	AR22G6L-10■3□ AR22G6L-01■3□ AR22G6L-11■3□ —	AR22G1L-10■4□ AR22G1L-01■4□ AR22G1L-11■4□ AR22G1L-22■4□	AR22G6L-10■4□ AR22G6L-01■4□ AR22G6L-11■4□ —
	With	1NO 1NC 1NO+1NC	AR22G1L-10■3□ AR22G1L-01■3□ AR22G1L-11■3□	AR22G6L-10■3□ AR22G6L-01■3□ AR22G6L-11■3□	AR22G1L-10■4□ AR22G1L-01■4□ AR22G1L-11■4□	AR22G6L-10■4□ AR22G6L-01■4□ AR22G6L-11■4□
Push-lock, turn-reset (40mm dia. with white arrow)  AF97-72	Without	1NO 1NC 1NO+1NC 3NC	— — — —	AR22V5L-10■3□ AR22V5L-01■3□ AR22V5L-11■3□ AR22V5L-03■3□	— — — —	AR22V5L-10■4□ AR22V5L-01■4□ AR22V5L-11■4□ AR22V5L-03■4□
	With	1NO 1NC 1NO+1NC	— — —	AR22V5L-10■3□ AR22V5L-01■3□ AR22V5L-11■3□	— — —	AR22V5L-10■4□ AR22V5L-01■4□ AR22V5L-11■4□
Flush square head  AF97-68	Without	1NO 1NC 1NO+1NC 2NO+2NC	AR22F0M-10■3□ AR22F0M-01■3□ AR22F0M-11■3□ AR22F0M-22■3□	AR22F5M-10■3□ AR22F5M-01■3□ AR22F5M-11■3□ —	AR22F0M-10■4□ AR22F0M-01■4□ AR22F0M-11■4□ AR22F0M-22■4□	AR22F5M-10■4□ AR22F5M-01■4□ AR22F5M-11■4□ —
	With	1NO 1NC 1NO+1NC	AR22F0M-10■3□ AR22F0M-01■3□ AR22F0M-11■3□	AR22F5M-10■3□ AR22F5M-01■3□ AR22F5M-11■3□	AR22F0M-10■4□ AR22F0M-01■4□ AR22F0M-11■4□	AR22F5M-10■4□ AR22F5M-01■4□ AR22F5M-11■4□
Extended square head  AF94-357	Without	1NO 1NC 1NO+1NC 2NO+2NC	AR22E0M-10■3□ AR22E0M-01■3□ AR22E0M-11■3□ AR22E0M-22■3□	AR22E5M-10■3□ AR22E5M-01■3□ AR22E5M-11■3□ —	AR22E0M-10■4□ AR22E0M-01■4□ AR22E0M-11■4□ AR22E0M-22■4□	AR22E5M-10■4□ AR22E5M-01■4□ AR22E5M-11■4□ —
	With	1NO 1NC 1NO+1NC	AR22E0M-10■3□ AR22E0M-01■3□ AR22E0M-11■3□	AR22E5M-10■3□ AR22E5M-01■3□ AR22E5M-11■3□	AR22E0M-10■4□ AR22E0M-01■4□ AR22E0M-11■4□	AR22E5M-10■4□ AR22E5M-01■4□ AR22E5M-11■4□
Flush round head with square bezel  AF94-315	Without	1NO 1NC 1NO+1NC 2NO+2NC	AR22F0P-10■3□ AR22F0P-01■3□ AR22F0P-11■3□ AR22F0P-22■3□	AR22F5P-10■3□ AR22F5P-01■3□ AR22F5P-11■3□ —	AR22F0P-10■4□ AR22F0P-01■4□ AR22F0P-11■4□ AR22F0P-22■4□	AR22F5P-10■4□ AR22F5P-01■4□ AR22F5P-11■4□ —
	With	1NO 1NC 1NO+1NC	AR22F0P-10■3□ AR22F0P-01■3□ AR22F0P-11■3□	AR22F5P-10■3□ AR22F5P-01■3□ AR22F5P-11■3□	AR22F0P-10■4□ AR22F0P-01■4□ AR22F0P-11■4□	AR22F5P-10■4□ AR22F5P-01■4□ AR22F5P-11■4□
Extended round head with square bezel  AF94-314	Without	1NO 1NC 1NO+1NC 2NO+2NC	AR22E0P-10■3□ AR22E0P-01■3□ AR22E0P-11■3□ AR22E0P-22■3□	AR22E5P-10■3□ AR22E5P-01■3□ AR22E5P-11■3□ —	AR22E0P-10■4□ AR22E0P-01■4□ AR22E0P-11■4□ AR22E0P-22■4□	AR22E5P-10■4□ AR22E5P-01■4□ AR22E5P-11■4□ —
	With	1NO 1NC 1NO+1NC	AR22E0P-10■3□ AR22E0P-01■3□ AR22E0P-11■3□	AR22E5P-10■3□ AR22E5P-01■3□ AR22E5P-11■3□	AR22E0P-10■4□ AR22E0P-01■4□ AR22E0P-11■4□	AR22E5P-10■4□ AR22E5P-01■4□ AR22E5P-11■4□

Note: ■ □ See page 19

Operator	Transformer	Contact	LED lamp		Incandescent lamp	
			Momentary action Type	Alternate action Type	Momentary action Type	Alternate action Type
Mushroom head with square bezel (29mm dia.)  AF94-440	Without	1NO	AR22M4P-10■□	—	AR22M4P-10■□	—
		1NC	AR22M4P-01■□	—	AR22M4P-01■□	—
		1NO+1NC	AR22M4P-11■□	—	AR22M4P-11■□	—
		2NO+2NC	AR22M4P-22■□	—	AR22M4P-22■□	—
With	1NO	AR22M4P-10■□	—	AR22M4P-10■□	—	
	1NC	AR22M4P-01■□	—	AR22M4P-01■□	—	
	1NO+1NC	AR22M4P-11■□	—	AR22M4P-11■□	—	

### •Lens color

Replace the □ mark by the lens color code

Color	Green	Red	White	Blue	Yellow	Orange
Code	G	R	W	S	Y	A

Note: AR22V5L type: Red, yellow only

### •Contact arrangements

Contact arrangements other than above are available

Contact arrangement	1NO	1NC	1NO+1NC	2NO	2NC	3NO
Code	10	01	11	20	02	30

Contact arrangement	3NC	2NO+2NC	4NO	4NC	5NO	5NC
Code	03	22	40	04	50	05

### Available numbers of contact blocks

Operation	Without transformer	With transformer
Momentary action	5-contact block	3-contact block
Alternate action Push-lock, turn-reset	3-contact block	2-contact block

### •Voltage

Replace the ■ mark by the lamp voltage code

Transformer		Code	
		LED	Incandescent
Without transformer	6V DC	6	—
	6V AC	A	—
	5.5V AC/DC	—	5
	12V AC/DC	B	—
	15V AC/DC	C	C
	20V AC/DC 24V AC/DC	— E	D E
With transformer	100-110V AC	H	H
	115-127V AC	L	L
	200-220V AC	M	M
	230-254V AC	Q	Q
	350-380V AC	S	S
	400-440V AC	T	T
	480V AC	V	V
	500-550V AC	W	W

# Pushbuttons

## AR22

### ■ Pushbutton switches

Operator	Contact	Momentary action Type	Alternate action Type
Flush round head  AF94-320	1NO 1NC 1NO+1NC 2NO 2NC 2NO+2NC	<b>AR22F0R-10</b> □ <b>AR22F5R-10</b> □ <b>AR22F0R-01</b> □ <b>AR22F5R-01</b> □ <b>AR22F0R-11</b> □ <b>AR22F5R-11</b> □ <b>AR22F0R-20</b> □ <b>AR22F5R-20</b> □ <b>AR22F0R-02</b> □ <b>AR22F5R-02</b> □ <b>AR22F0R-22</b> □ <b>AR22F5R-22</b> □	
Extended round head  AF94-319	1NO 1NC 1NO+1NC 2NO 2NC 2NO+2NC	<b>AR22E0R-10</b> □ <b>AR22E5R-10</b> □ <b>AR22E0R-01</b> □ <b>AR22E5R-01</b> □ <b>AR22E0R-11</b> □ <b>AR22E5R-11</b> □ <b>AR22E0R-20</b> □ <b>AR22E5R-20</b> □ <b>AR22E0R-02</b> □ <b>AR22E5R-02</b> □ <b>AR22E0R-22</b> □ <b>AR22E5R-22</b> □	
Flush round head symbol mark type  AF98-193	1NO 1NC 1NO+1NC 2NO 2NC 2NO+2NC	<b>AR22FAR-10C</b> ■ <b>AR22FBR-10C</b> ■ <b>AR22FAR-01C</b> ■ <b>AR22FBR-01C</b> ■ <b>AR22FAR-11C</b> ■ <b>AR22FBR-11C</b> ■ <b>AR22FAR-20C</b> ■ <b>AR22FBR-20C</b> ■ <b>AR22FAR-02C</b> ■ <b>AR22FBR-02C</b> ■ <b>AR22FAR-22C</b> ■ <b>AR22FBR-22C</b> ■	
Extended round head symbol mark type  AF98-192	1NO 1NC 1NO+1NC 2NO 2NC 2NO+2NC	<b>AR22EAR-10C</b> ■ <b>AR22EBR-10C</b> ■ <b>AR22EAR-01C</b> ■ <b>AR22EBR-01C</b> ■ <b>AR22EAR-11C</b> ■ <b>AR22EBR-11C</b> ■ <b>AR22EAR-20C</b> ■ <b>AR22EBR-20C</b> ■ <b>AR22EAR-02C</b> ■ <b>AR22EBR-02C</b> ■ <b>AR22EAR-22C</b> ■ <b>AR22EBR-22C</b> ■	
Mushroom head (40mm dia.)  AF94-293	1NO 1NC 1NO+1NC 2NO 2NC 2NO+2NC	<b>AR22M0R-10</b> □ <b>AR22M5R-10</b> □ <b>AR22M0R-01</b> □ <b>AR22M5R-01</b> □ <b>AR22M0R-11</b> □ <b>AR22M5R-11</b> □ <b>AR22M0R-20</b> □ <b>AR22M5R-20</b> □ <b>AR22M0R-02</b> □ <b>AR22M5R-02</b> □ <b>AR22M0R-22</b> □ <b>AR22M5R-22</b> □	
Mushroom head (29mm dia.)  AF94-321	1NO 1NC 1NO+1NC 2NO 2NC 2NO+2NC	<b>AR22M4R-10</b> □ <b>AR22M9R-10</b> □ <b>AR22M4R-01</b> □ <b>AR22M9R-01</b> □ <b>AR22M4R-11</b> □ <b>AR22M9R-11</b> □ <b>AR22M4R-20</b> □ <b>AR22M9R-20</b> □ <b>AR22M4R-02</b> □ <b>AR22M9R-02</b> □ <b>AR22M4R-22</b> □ <b>AR22M9R-22</b> □	
Extended with full guard (24mm dia.)  AF94-292	1NO 1NC 1NO+1NC 2NO 2NC 2NO+2NC	<b>AR22G3R-10</b> □ <b>AR22G8R-10</b> □ <b>AR22G3R-01</b> □ <b>AR22G8R-01</b> □ <b>AR22G3R-11</b> □ <b>AR22G8R-11</b> □ <b>AR22G3R-20</b> □ <b>AR22G8R-20</b> □ <b>AR22G3R-02</b> □ <b>AR22G8R-02</b> □ <b>AR22G3R-22</b> □ <b>AR22G8R-22</b> □	

Operator	Contact	Momentary action Type	Alternate action Type
Flush with full guard (24mm dia.)  AF02-68	1NO 1NC 1NO+1NC 2NO 2NC 2NO+2NC	<b>AR22G2R-10</b> □ <b>AR22G7R-10</b> □ <b>AR22G2R-01</b> □ <b>AR22G7R-01</b> □ <b>AR22G2R-11</b> □ <b>AR22G7R-11</b> □ <b>AR22G2R-20</b> □ <b>AR22G7R-20</b> □ <b>AR22G2R-02</b> □ <b>AR22G7R-02</b> □ <b>AR22G2R-22</b> □ <b>AR22G7R-22</b> □	
Mushroom head with full guard (40mm dia.)  AF94-372	1NO 1NC 1NO+1NC 2NO 2NC 2NO+2NC	<b>AR22M3R-10</b> □ <b>AR22M8R-10</b> □ <b>AR22M3R-01</b> □ <b>AR22M8R-01</b> □ <b>AR22M3R-11</b> □ <b>AR22M8R-11</b> □ <b>AR22M3R-20</b> □ <b>AR22M8R-20</b> □ <b>AR22M3R-02</b> □ <b>AR22M8R-02</b> □ <b>AR22M3R-22</b> □ <b>AR22M8R-22</b> □	
Extended with half guard  AF96-236	1NO 1NC 1NO+1NC 2NO 2NC 2NO+2NC	<b>AR22G0R-10</b> □ <b>AR22G5R-10</b> □ <b>AR22G0R-01</b> □ <b>AR22G5R-01</b> □ <b>AR22G0R-11</b> □ <b>AR22G5R-11</b> □ <b>AR22G0R-20</b> □ <b>AR22G5R-20</b> □ <b>AR22G0R-02</b> □ <b>AR22G5R-02</b> □ <b>AR22G0R-22</b> □ <b>AR22G5R-22</b> □	
Push-lock, turn-reset (40mm dia. with white arrow)  AF97-70	1NO 1NC 1NO+1NC 2NO 2NC 2NO+2NC	— — — — — —	<b>AR22V5R-10</b> □ <b>AR22V5R-01</b> □ <b>AR22V5R-11</b> □ <b>AR22V5R-20</b> □ <b>AR22V5R-02</b> □ <b>AR22V5R-22</b> □
Flush square head  AF94-316	1NO 1NC 1NO+1NC 2NO 2NC 2NO+2NC	<b>AR22F0S-10</b> □ <b>AR22F5S-10</b> □ <b>AR22F0S-01</b> □ <b>AR22F5S-01</b> □ <b>AR22F0S-11</b> □ <b>AR22F5S-11</b> □ <b>AR22F0S-20</b> □ <b>AR22F5S-20</b> □ <b>AR22F0S-02</b> □ <b>AR22F5S-02</b> □ <b>AR22F0S-22</b> □ <b>AR22F5S-22</b> □	
Extended square head  AF94-296	1NO 1NC 1NO+1NC 2NO 2NC 2NO+2NC	<b>AR22E0S-10</b> □ <b>AR22E5S-10</b> □ <b>AR22E0S-01</b> □ <b>AR22E5S-01</b> □ <b>AR22E0S-11</b> □ <b>AR22E5S-11</b> □ <b>AR22E0S-20</b> □ <b>AR22E5S-20</b> □ <b>AR22E0S-02</b> □ <b>AR22E5S-02</b> □ <b>AR22E0S-22</b> □ <b>AR22E5S-22</b> □	
Flush round head with square bezel  AF94-295	1NO 1NC 1NO+1NC 2NO 2NC 2NO+2NC	<b>AR22F0Y-10</b> □ <b>AR22F5Y-10</b> □ <b>AR22F0Y-01</b> □ <b>AR22F5Y-01</b> □ <b>AR22F0Y-11</b> □ <b>AR22F5Y-11</b> □ <b>AR22F0Y-20</b> □ <b>AR22F5Y-20</b> □ <b>AR22F0Y-02</b> □ <b>AR22F5Y-02</b> □ <b>AR22F0Y-22</b> □ <b>AR22F5Y-22</b> □	

Note: ■ □ See page 21

Operator	Contact	Momentary action Type	Alternate action Type
Extended round head with square bezel 	1NO	<b>AR22E0Y-10</b> □	<b>AR22E5Y-10</b> □
	1NC	<b>AR22E0Y-01</b> □	<b>AR22E5Y-01</b> □
	1NO+1NC	<b>AR22E0Y-11</b> □	<b>AR22E5Y-11</b> □
	2NO	<b>AR22E0Y-20</b> □	<b>AR22E5Y-20</b> □
	2NC	<b>AR22E0Y-02</b> □	<b>AR22E5Y-02</b> □
	2NO+2NC	<b>AR22E0Y-22</b> □	<b>AR22E5Y-22</b> □

Operator	Contact	Momentary action Type	Alternate action Type
Mushroom head with square bezel (29mm dia.) 	1NO	<b>AR22M4Y-10</b> □	—
	1NC	<b>AR22M4Y-01</b> □	—
	1NO+1NC	<b>AR22M4Y-11</b> □	—
	2NO	<b>AR22M4Y-20</b> □	—
	2NC	<b>AR22M4Y-02</b> □	—
	2NO+2NC	<b>AR22M4Y-22</b> □	—

### •Button color

Replace the □ mark by the button color code

Color	Green	Red	White	Blue	Yellow	Orange	Black
Code	G	R	W	S	Y	A	B

Note: AR22V5R type: Red, yellow, black only

### •Available numbers of contact blocks

Momentary action	Alternate action Push-lock, turn-reset
6-contact block	4-contact block

### •Contact arrangements

Contact arrangements other than above are available

Contact arrangement	1NO	1NC	1NO+1NC	2NO	2NC	3NO	3NC
Code	10	01	11	20	02	30	03



Contact arrangement	2NO+2NC	4NO	4NC	5NO	5NC	3NO+3NC
Code	22	40	04	50	05	33

### •Symbol mark (For AR22FAR, FBR, EAR, EBR)

Replace the ■ mark by the symbol mark code

Symbol mark	○	I	⊕	⊖	⊕	⊖	⊕	⊖
Color of button	White	Black	White	Black	White	Black	Clear	
Color of mark	Red		Green		Green		Black	
Code	01	02	03	04	11	12	02B	04B 12B

# Pushbuttons AR22

Operator	Contact (The following contact is only available.)	Button color	Type	Contact operation					
				Contact block		Left 		Right 	
				Mounting position	Type	Free	Depressed	Free	Depressed
Pushbutton with selector ring (2-position)  AF94-355	2NO+2NC	Green Red Black White Yellow Orange Blue	<b>AR22S1R-22G</b> <b>AR22S1R-22R</b> <b>AR22S1R-22B</b> <b>AR22S1R-22W</b> <b>AR22S1R-22Y</b> <b>AR22S1R-22A</b> <b>AR22S1R-22S</b>	(1)	NC	—	—	●	—
				(2)	NC	—	—	●	—
				(3)	NO	—	●	—	●
				(4)	NO	—	●	—	●
	2NO	Green Red Black White Yellow Orange Blue	<b>AR22S2R-20G</b> <b>AR22S2R-20R</b> <b>AR22S2R-20B</b> <b>AR22S2R-20W</b> <b>AR22S2R-20Y</b> <b>AR22S2R-20A</b> <b>AR22S2R-20S</b>	(1)	NO	—	●	—	—
				(2)	NO	—	—	—	●
				(3)					
				(4)					
	2NO+2NC	Green Red Black White Yellow Orange Blue	<b>AR22S2R-22G</b> <b>AR22S2R-22R</b> <b>AR22S2R-22B</b> <b>AR22S2R-22W</b> <b>AR22S2R-22Y</b> <b>AR22S2R-22A</b> <b>AR22S2R-22S</b>	(1)	NC	●	—	—————	
				(2)	NC	—————		●	—
				(3)	NO	—	●	—	—
				(4)	NO	—	—	—	●
	2NO+2NC	Green Red Black White Yellow Orange Blue	<b>AR22S3R-22G</b> <b>AR22S3R-22R</b> <b>AR22S3R-22B</b> <b>AR22S3R-22W</b> <b>AR22S3R-22Y</b> <b>AR22S3R-22A</b> <b>AR22S3R-22S</b>	(1)	NC	—	—	—————	
				(2)	NC	—————		—	—
				(3)	NO	—	●	—	—
				(4)	NO	—	—	—	●
	2NO+2NC	Green Red Black White Yellow Orange Blue	<b>AR22S6R-22G</b> <b>AR22S6R-22R</b> <b>AR22S6R-22B</b> <b>AR22S6R-22W</b> <b>AR22S6R-22Y</b> <b>AR22S6R-22A</b> <b>AR22S6R-22S</b>	(1)	NC	●	—	—	Locked
				(2)	NC	●	—	—	
				(3)	NO	—	●	●	
				(4)	NO	—	●	●	

Note: (1) to (4): Contact block mounting position

● Contact closed  
— Contact open



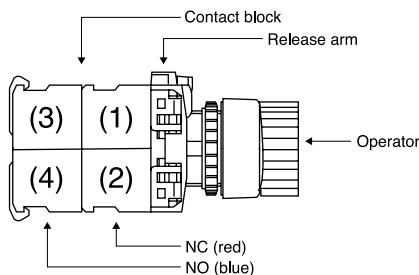

## •Position of contact block





## ■ Emergency stop pushbutton switches

⊙ (Direct opening action), conform to EN418

Operator	Contact	Type
Push-lock, turn-reset (Soft-touch 40mm dia. with white arrow)  <small>AF97-70</small>	1NC 1NO+1NC 2NC 2NO+2NC	<b>AR22V0R-01R</b> <b>AR22V0R-11R</b> <b>AR22V0R-02R</b> <b>AR22V0R-22R</b>
Push-lock, turn-reset (40mm dia.)  <small>AF94-432</small>	1NC 1NO+1NC 2NC 2NO+2NC	<b>AR22V2R-01R</b> <b>AR22V2R-11R</b> <b>AR22V2R-02R</b> <b>AR22V2R-22R</b>
Push-lock, turn-reset (Soft-touch 29mm dia. with white arrow)  <small>AF99-317</small>	1NC 1NO+1NC 2NC 2NO+2NC	<b>AR22VSR-01R</b> <b>AR22VSR-11R</b> <b>AR22VSR-02R</b> <b>AR22VSR-22R</b>
Push-lock, turn-reset (29mm dia.)  <small>AF95-53</small>	1NC 1NO+1NC 2NC 2NO+2NC	<b>AR22V4R-01R</b> <b>AR22V4R-11R</b> <b>AR22V4R-02R</b> <b>AR22V4R-22R</b>



Note: • Button color: Red only

## •Contact arrangements

Contact arrangements other than above are available

Contact arrangement	1NO	1NO+1NC	2NC	3NC	2NO+2NC	4NC
Code	01	11	02	03	22	04

Note: • Except AR22Q2R and AR22VGE  
 • For AR22Q2R and AR22VGE, up to 2-contact block.







Operator	Contact	Type
Key release push-lock, turn-reset (40mm dia.)  <small>AF98-37</small>	1NC 1NO+1NC 2NC 2NO+2NC	<b>AR22V7R-01R</b> <b>AR22V7R-11R</b> <b>AR22V7R-02R</b> <b>AR22V7R-22R</b>
Push-lock, pull-reset (35mm dia.)  <small>AF94-52</small>	1NC 1NO+1NC 2NC	<b>AR22Q2R-01R</b> <b>AR22Q2R-11R</b> <b>AR22Q2R-02R</b>
Unibody push-lock, turn-reset (Soft-touch 40mm dia. with white arrow)  <small>KK03-037</small>	1NC 1NO+1NC 2NC	<b>AR22VGE-01R</b> <b>AR22VGE-11R</b> <b>AR22VGE-02R</b>

# Emergency Stop Illuminated Pushbuttons

## AR22

### ■ Emergency stop illuminated pushbutton switches

⊕ (Direct opening action), conform to EN418

Operator	Transformer	Contact	LED lamp Type	Incandescent lamp Type	Neon lamp Type
Push-lock, turn-reset (Soft-touch 40mm dia. with white arrow)  <small>AF97-76</small>	Without	1NC 1NO+1NC 2NC 3NC	AR22V0L-01■3R AR22V0L-11■3R AR22V0L-02■3R AR22V0L-03■3R	AR22V0L-01■4R AR22V0L-11■4R AR22V0L-02■4R AR22V0L-03■4R	— — — —
	With	1NC 1NO+1NC 2NC	AR22V0L-01■3R AR22V0L-11■3R AR22V0L-02■3R	AR22V0L-01■4R AR22V0L-11■4R AR22V0L-02■4R	— — —
Push-lock, turn-reset (40mm dia.)  <small>AF94-307</small>	Without	1NC 1NO+1NC 2NC 3NC	AR22V2L-01■3R AR22V2L-11■3R AR22V2L-02■3R AR22V2L-03■3R	AR22V2L-01■4R AR22V2L-11■4R AR22V2L-02■4R AR22V2L-03■4R	— — — —
	With	1NC 1NO+1NC 2NC	AR22V2L-01■3R AR22V2L-11■3R AR22V2L-02■3R	AR22V2L-01■4R AR22V2L-11■4R AR22V2L-02■4R	— — —
Push-lock, turn-reset (Soft-touch 40mm dia. transparent in all colors with white arrow)  <small>AF97-76</small>	Without	1NC 1NO+1NC 2NC 3NC	AR22VDL-01■3R AR22VDL-11■3R AR22VDL-02■3R AR22VDL-03■3R	AR22VDL-01■4R AR22VDL-11■4R AR22VDL-02■4R AR22VDL-03■4R	— — — —
	With	1NC 1NO+1NC 2NC	AR22VDL-01■3R AR22VDL-11■3R AR22VDL-02■3R	AR22VDL-01■4R AR22VDL-11■4R AR22VDL-02■4R	— — —
Push-lock, turn-reset (40mm dia. transparent in all colors)  <small>AF94-364</small>	Without	1NC 1NO+1NC 2NC 3NC	AR22VAL-01■3R AR22VAL-11■3R AR22VAL-02■3R AR22VAL-03■3R	AR22VAL-01■4R AR22VAL-11■4R AR22VAL-02■4R AR22VAL-03■4R	— — — —
	With	1NC 1NO+1NC 2NC	AR22VAL-01■3R AR22VAL-11■3R AR22VAL-02■3R	AR22VAL-01■4R AR22VAL-11■4R AR22VAL-02■4R	— — —
Push-lock, turn-reset (Soft-touch 29mm dia. with white arrow)  <small>AF99-316</small>	Without	1NC 1NO+1NC 2NC 3NC	AR22VSL-01■3R AR22VSL-11■3R AR22VSL-02■3R AR22VSL-03■3R	AR22VSL-01■4R AR22VSL-11■4R AR22VSL-02■4R AR22VSL-03■4R	— — — —
	With	1NC 1NO+1NC 2NC	AR22VSL-01■3R AR22VSL-11■3R AR22VSL-02■3R	AR22VSL-01■4R AR22VSL-11■4R AR22VSL-02■4R	— — —
Unibody push-lock, turn-reset (Soft-touch 40mm dia. with white arrow) 	Without	1NC  1NO+1NC  2NC	AR22VGF-01E3R  AR22VGF-11E3R  AR22VGF-02E3R	—  —  —	AR22VGF-01■1R  AR22VGF-11■1R  AR22VGF-02■1R

Notes: • Button color: Red only • AR22VGF type: Lamp circuit contacts are provided, see page 43. • Contact arrangements indicated in the table can be supplied.

### •Voltage









Replace the ■ mark by the lamp voltage code

Transformer	Code	LED		
		LED	Incandescent	Neon
Without	6V DC	6	—	—
	6V AC	A	—	—
	5V AC/DC	—	5	—
	12V AC/DC	B	—	—
	15V AC/DC	C	C	—
	20V AC/DC	—	D	—
	24V AC/DC	E	E	—
	110V AC	—	—	H
	120V AC	—	—	K
	220V AC	—	—	M
	240V AC	—	—	P

Transformer	Code	LED	
		LED	Incandescent
With	100-110V AC	H	H
	115-127V AC	L	L
	200-220V AC	M	M
	230-254V AC	Q	Q
	350-380V AC	S	S
	400-440V AC	T	T
	480V AC	V	V
	500-550V AC	W	W

Notes: AR22VGF: LED 24V AC/DC and neon only

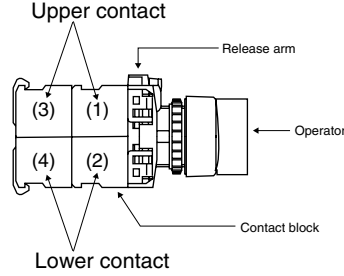
## ■ Selector switches 2-position

Operator	Operation	Knob color or key removable position	Contact	Type		Contact operation (Example)		
				Switch with round bezel	Switch with square bezel	Contact arrangement	Operator position	
							Left	Right
Knob   <small>AF94-310</small>	Maintained	Color code: B: Black (Standard) Color other than above are available (G: Green) (R: Red)	1NO 1NC 1NO+1NC 2NO 2NC 2NO+2NC	<b>AR22PR-210B</b> <b>AR22PR-201B</b> <b>AR22PR-211B</b> <b>AR22PR-220B</b> <b>AR22PR-202B</b> <b>AR22PR-222B</b>	<b>AR22PY-210B</b> <b>AR22PY-201B</b> <b>AR22PY-211B</b> <b>AR22PY-220B</b> <b>AR22PY-202B</b> <b>AR22PY-222B</b>	1NO (1)	Upper contact  	
	each 90°  Spring return  60°		1NO 1NC 1NO+1NC 2NO 2NC 2NO+2NC	<b>AR22PR-010B</b> <b>AR22PR-001B</b> <b>AR22PR-011B</b> <b>AR22PR-020B</b> <b>AR22PR-002B</b> <b>AR22PR-022B</b>	<b>AR22PY-010B</b> <b>AR22PY-001B</b> <b>AR22PY-011B</b> <b>AR22PY-020B</b> <b>AR22PY-002B</b> <b>AR22PY-022B</b>	1NC (1)	Upper contact  	
Lever   <small>AF94-324</small>	Maintained		1NO 1NC 1NO+1NC 2NO 2NC 2NO+2NC	<b>AR22WR-210B</b> <b>AR22WR-201B</b> <b>AR22WR-211B</b> <b>AR22WR-220B</b> <b>AR22WR-202B</b> <b>AR22WR-222B</b>	<b>AR22WY-210B</b> <b>AR22WY-201B</b> <b>AR22WY-211B</b> <b>AR22WY-220B</b> <b>AR22WY-202B</b> <b>AR22WY-222B</b>	(1)	Upper contact  	
	each 90°  Spring return  60°		1NO 1NC 1NO+1NC 2NO 2NC 2NO+2NC	<b>AR22WR-010B</b> <b>AR22WR-001B</b> <b>AR22WR-011B</b> <b>AR22WR-020B</b> <b>AR22WR-002B</b> <b>AR22WR-022B</b>	<b>AR22WY-010B</b> <b>AR22WY-001B</b> <b>AR22WY-011B</b> <b>AR22WY-020B</b> <b>AR22WY-002B</b> <b>AR22WY-022B</b>	2NO+2NC (1)	Upper contact  	
Cylindrical knob   <small>AF94-308</small>	Maintained		1NO 1NC 1NO+1NC 2NO 2NC 2NO+2NC	<b>AR22RR-210B</b> <b>AR22RR-201B</b> <b>AR22RR-211B</b> <b>AR22RR-220B</b> <b>AR22RR-202B</b> <b>AR22RR-222B</b>	<b>AR22RY-210B</b> <b>AR22RY-201B</b> <b>AR22RY-211B</b> <b>AR22RY-220B</b> <b>AR22RY-202B</b> <b>AR22RY-222B</b>	(3)	Upper contact  	
	each 90°  Spring return  60°		1NO 1NC 1NO+1NC 2NO 2NC 2NO+2NC	<b>AR22RR-010B</b> <b>AR22RR-001B</b> <b>AR22RR-011B</b> <b>AR22RR-020B</b> <b>AR22RR-002B</b> <b>AR22RR-022B</b>	<b>AR22RY-010B</b> <b>AR22RY-001B</b> <b>AR22RY-011B</b> <b>AR22RY-020B</b> <b>AR22RY-002B</b> <b>AR22RY-022B</b>	(2) (4)	Lower contact  	
Key   <small>AF94-311</small>	Maintained	■: Key removable position ( ): Key type  <i>See page 27</i>	1NO 1NC 1NO+1NC 2NO 2NC 2NO+2NC	<b>AR22J□R-2■10( )</b> <b>AR22J□R-2■01( )</b> <b>AR22J□R-2■11( )</b> <b>AR22J□R-2■20( )</b> <b>AR22J□R-2■02( )</b> <b>AR22J□R-2■22( )</b>	<b>AR22JY-2■10( )</b> <b>AR22JY-2■01( )</b> <b>AR22JY-2■11( )</b> <b>AR22JY-2■20( )</b> <b>AR22JY-2■02( )</b> <b>AR22JY-2■22( )</b>	(1)		
	each 90°  Spring return  60°		1NO 1NC 1NO+1NC 2NO 2NC 2NO+2NC	<b>AR22J□R-0A10( )</b> <b>AR22J□R-0A01( )</b> <b>AR22J□R-0A11( )</b> <b>AR22J□R-0A20( )</b> <b>AR22J□R-0A02( )</b> <b>AR22J□R-0A22( )</b>	<b>AR22JY-0A10( )</b> <b>AR22JY-0A01( )</b> <b>AR22JY-0A11( )</b> <b>AR22JY-0A20( )</b> <b>AR22JY-0A02( )</b> <b>AR22JY-0A22( )</b>	(2)		Lower contact

Notes: • (1) to (4): Contact block mounting position  
 • ①-②, ③-④: Contact block terminal No.  
 • Contact arrangements: See page 27









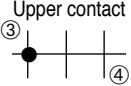
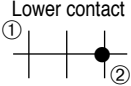

● Contact closed

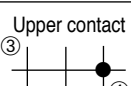
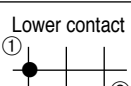
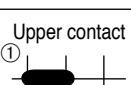
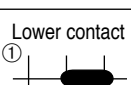

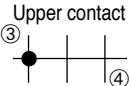
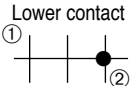
### • Operator

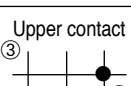
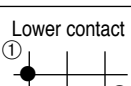
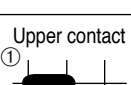
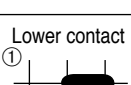
Replace the □ mark by the cylinder key type code  
 Standard type: Blank  
 Long durability type: A

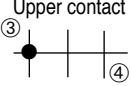
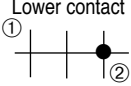
# Selector Switches AR22

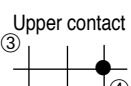
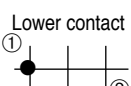
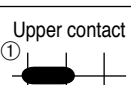
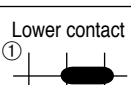
## 3-position

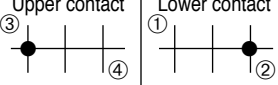
Operator	Operation	Knob color	Contact	Type Switch with round bezel	Switch with square bezel	Contact operation (Example)			
						Contact arrange- ment	Operation position		
							L	C	R
 AF94-310	Maintained each 45°	Color code: B: Black (Standard) Color other than above are available (G: Green) (R: Red)	1NO+1NC 2NO 2NC 2NO+2NC	<b>AR22PR-311B</b> <b>AR22PR-320B</b> <b>AR22PR-302B</b> <b>AR22PR-322B</b>	<b>AR22PY-311B</b> <b>AR22PY-320B</b> <b>AR22PY-302B</b> <b>AR22PY-322B</b>	1NO+1NC (1) (2)	 Upper contact  Lower contact		
	Spring/manual return each 45°		1NO+1NC 2NO 2NC 2NO+2NC	<b>AR22PR-611B</b> <b>AR22PR-620B</b> <b>AR22PR-602B</b> <b>AR22PR-622B</b>	<b>AR22PY-611B</b> <b>AR22PY-620B</b> <b>AR22PY-602B</b> <b>AR22PY-622B</b>	1NO+1NC (1) (2)	 Upper contact  Lower contact		
	Spring/manual return each 45°		1NO+1NC 2NO 2NC 2NO+2NC	<b>AR22PR-711B</b> <b>AR22PR-720B</b> <b>AR22PR-702B</b> <b>AR22PR-722B</b>	<b>AR22PY-711B</b> <b>AR22PY-720B</b> <b>AR22PY-702B</b> <b>AR22PY-722B</b>	1NO+1NC (1) (2)	 Upper contact  Lower contact		
	Spring return each 45°		2NO+2NC	<b>AR22PR-122B</b> <b>AR22PY-122B</b>	2NO+2NC (1) (2)	 Upper contact  Lower contact			
 AF94-324	Maintained each 45°		1NO+1NC 2NO 2NC 2NO+2NC	<b>AR22WR-311B</b> <b>AR22WR-320B</b> <b>AR22WR-302B</b> <b>AR22WR-322B</b>	<b>AR22WY-311B</b> <b>AR22WY-320B</b> <b>AR22WY-302B</b> <b>AR22WY-322B</b>	1NO+1NC (1) (2)	 Upper contact  Lower contact		
	Spring/manual return each 45°		1NO+1NC 2NO 2NC 2NO+2NC	<b>AR22WR-611B</b> <b>AR22WR-620B</b> <b>AR22WR-602B</b> <b>AR22WR-622B</b>	<b>AR22WY-611B</b> <b>AR22WY-620B</b> <b>AR22WY-602B</b> <b>AR22WY-622B</b>	1NO+1NC (1) (2)	 Upper contact  Lower contact		
	Spring/manual return each 45°		1NO+1NC 2NO 2NC 2NO+2NC	<b>AR22WR-711B</b> <b>AR22WR-720B</b> <b>AR22WR-702B</b> <b>AR22WR-722B</b>	<b>AR22WY-711B</b> <b>AR22WY-720B</b> <b>AR22WY-702B</b> <b>AR22WY-722B</b>	1NO+1NC (1) (2)	 Upper contact  Lower contact		
	Spring return each 45°		2NO+2NC	<b>AR22WR-122B</b> <b>AR22WY-122B</b>	2NO+2NC (1) (2)	 Upper contact  Lower contact			
 AF94-308	Maintained each 45°		1NO+1NC 2NO 2NC 2NO+2NC	<b>AR22RR-311B</b> <b>AR22RR-320B</b> <b>AR22RR-302B</b> <b>AR22RR-322B</b>	<b>AR22RY-311B</b> <b>AR22RY-320B</b> <b>AR22RY-302B</b> <b>AR22RY-322B</b>	1NO+1NC (1) (2)	 Upper contact  Lower contact		
	Spring/manual return each 45°		1NO+1NC 2NO 2NC 2NO+2NC	<b>AR22RR-611B</b> <b>AR22RR-620B</b> <b>AR22RR-602B</b> <b>AR22RR-622B</b>	<b>AR22RY-611B</b> <b>AR22RY-620B</b> <b>AR22RY-602B</b> <b>AR22RY-622B</b>	1NO+1NC (1) (2)	 Upper contact  Lower contact		
	Spring/manual return each 45°		1NO+1NC 2NO 2NC 2NO+2NC	<b>AR22RR-711B</b> <b>AR22RR-720B</b> <b>AR22RR-702B</b> <b>AR22RR-722B</b>	<b>AR22RY-711B</b> <b>AR22RY-720B</b> <b>AR22RY-702B</b> <b>AR22RY-722B</b>	1NO+1NC (1) (2)	 Upper contact  Lower contact		
	Spring return each 45°		2NO+2NC	<b>AR22RR-122B</b> <b>AR22RY-122B</b>	2NO+2NC (1) (2)	 Upper contact  Lower contact			

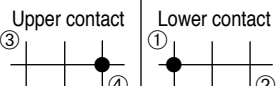
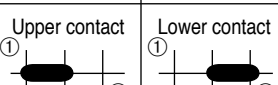
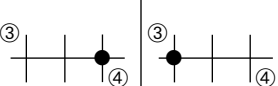
Operator	Operation	Key removable position	Contact	Type Switch with round bezel      Switch with square bezel	Contact operation (Example)						
					Contact arrangement	Operator position			L	C	R
						⊖	⊕	⊗			
 AF94-311	Maintained each 45°	■: Key removable position ( ): Key type	1NO+1NC 2NO 2NC 2NO+2NC	<b>AR22J□R-3■11( )</b> <b>AR22JY-3■11( )</b> <b>AR22J□R-3■20( )</b> <b>AR22JY-3■20( )</b> <b>AR22J□R-3■02( )</b> <b>AR22JY-3■02( )</b> <b>AR22J□R-3■22( )</b> <b>AR22JY-3■22( )</b>	1NO+1NC (1) (2)	Upper contact ③	Lower contact ①				
	Spring/manual return ⊕ each 45°		1NO+1NC 2NO 2NC 2NO+2NC	<b>AR22J□R-6■11( )</b> <b>AR22JY-6■11( )</b> <b>AR22J□R-6■20( )</b> <b>AR22JY-6■20( )</b> <b>AR22J□R-6■02( )</b> <b>AR22JY-6■02( )</b> <b>AR22J□R-6■22( )</b> <b>AR22JY-6■22( )</b>	1NO+1NC (1) (2)	Upper contact ③	Lower contact ①				
	Spring/manual return ⊕ each 45°		1NO+1NC 2NO 2NC 2NO+2NC	<b>AR22J□R-7■11( )</b> <b>AR22JY-7■11( )</b> <b>AR22J□R-7■20( )</b> <b>AR22JY-7■20( )</b> <b>AR22J□R-7■02( )</b> <b>AR22JY-7■02( )</b> <b>AR22J□R-7■22( )</b> <b>AR22JY-7■22( )</b>	1NO+1NC (1) (2)	Upper contact ③	Lower contact ①				
	Spring return ⊖ each 45°		2NO+2NC	<b>AR22J□R-1E22( )</b> <b>AR22JY-1E22( )</b>	2NO+2NC (1) (2)  (3) (4)	Upper contact ①	Lower contact ①	  			

Notes: • Operator position    L:Left, C:Center, R:Right  
 • (1) to (4): Contact block mounting position  
 • ①-②, ③-④: Contact block terminal No.

● Contact closed

### • Contact arrangements

Contact arrangements other than above are available







Contact arrangement	1NO	1NC	1NO+1NC	2NO	2NC	3NO	3NC
Code	10	01	11	20	02	30	03

Contact arrangement	2NO+2NC	4NO	4NC	5NO	5NC	3NO+3NC
Code	22	40	04	50	05	33

### • Available numbers of contact blocks

Mainted	Spring return Spring/manual return
6-contact block	4-contact block

### • Key removable positions

Code	A	B	C	D	E	F	G
Removable position							
AR22J□R-2	●	●	—	●	—	—	—
AR22J□R-0	●	—	—	—	—	—	—
AR22J□R-3	●	●	●	●	●	●	●
AR22J□R-6	—	—	—	●	●	●	—
AR22J□R-7	●	—	—	—	●	—	●
AR22J□R-1	—	—	—	—	●	—	—

●: Available      —: Not available

### • Position of contact block

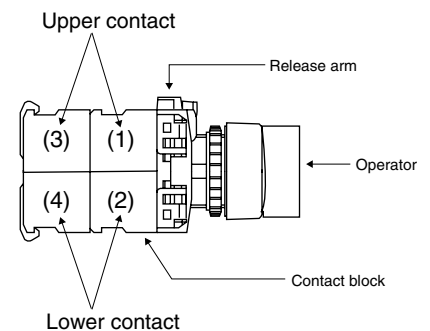

### • Key code No.

Replace the ( ) mark with one of the following key code.  
 A, B, C, D, E and F  
 Standard key code is A.

















### • Operator

Replace the □ mark by the cylinder key type code  
 Standard type: Blank  
 Long durability type: A







# Selector Switches AR22

## ■ Selector switches (control type)

### 3-position

Operator	Operation	Knob color or key removable position	Contact arrangement	Type	
				Switch with round bezel	Switch with square bezel
Knob  <small>AF94-435</small>	Maintained each 45°	Color code: B: Black (Standard) Color other than above are available (G: Green) (R: Red)	Replace the ■ mark by the contact arrangement code (shown on next page).	<b>AR22PCR-3■B</b>	<b>AR22PCY-3■B</b>
	Spring/manual return  each 45°			<b>AR22PCR-6■B</b>	<b>AR22PCY-6■B</b>
	Spring/manual return  each 45°			<b>AR22PCR-7■B</b>	<b>AR22PCY-7■B</b>
	Spring return  each 45°			<b>AR22PCR-1■B</b>	<b>AR22PCY-1■B</b>
Lever  <small>AF94-436</small>	Maintained each 45°	Replace the ■ mark by the contact arrangement code (shown on next page).	Replace the ■ mark by the contact arrangement code (shown on next page).	<b>AR22WCR-3■B</b>	<b>AR22WCY-3■B</b>
	Spring/manual return  each 45°			<b>AR22WCR-6■B</b>	<b>AR22WCY-6■B</b>
	Spring/manual return  each 45°			<b>AR22WCR-7■B</b>	<b>AR22WCY-7■B</b>
	Spring return  each 45°			<b>AR22WCR-1■B</b>	<b>AR22WCY-1■B</b>
Cylindrical knob  <small>AF94-433</small>	Maintained each 45°	Replace the ■ mark by the contact arrangement code (shown on next page).	Replace the ■ mark by the contact arrangement code (shown on next page).	<b>AR22RCR-3■B</b>	<b>AR22RCY-3■B</b>
	Spring/manual return  each 45°			<b>AR22RCR-6■B</b>	<b>AR22RCY-6■B</b>
	Spring/manual return  each 45°			<b>AR22RCR-7■B</b>	<b>AR22RCY-7■B</b>
	Spring return  each 45°			<b>AR22RCR-1■B</b>	<b>AR22RCY-1■B</b>
Key  <small>AF94-434</small>	Maintained each 45°	Replace the □ mark by the key removable position code: A, B, C, D, E, F or G	Replace the ■ mark by the contact arrangement code (shown on next page).	<b>AR22JCR-3□■( )</b>	<b>AR22JCY-3□□( )</b>
	Spring/manual return  each 45°			<b>AR22JCR-6□■( )</b>	<b>AR22JCY-6□□( )</b>
	Spring/manual return  each 45°			<b>AR22JCR-7□■( )</b>	<b>AR22JCY-7□□( )</b>
	Spring return  each 45°			<b>AR22JCR-1E■( )</b>	<b>AR22JCY-1E■( )</b>

### • Key removable positions

Code	A	B	C	D	E	F	G
Removable position							
AR22JCR-3	●	●	●	●	●	●	●
AR22JCR-6	—	—	—	●	●	●	—
AR22JCR-7	●	—	—	—	●	—	●
AR22JCR-1	—	—	—	—	●	—	—

●: Available    —: Not available

### •Key code No.

Replace the ( ) mark with one of the following key code.  
 A, B, C, D, E and F  
 Standard key code is A.

• **Contact arrangement code (Typical example)**

Contact arrangement	Contact arrangement code	Contact operation				
		Contact block		Operator position		
		Mounting position	Type	Left	Center	Right
2NC	01F	(1)	NC			
		(2)	NC			
		-	-	-	-	-
		-	-	-	-	-
2NO+2NC	014	(1)	NC			
		(2)	NC			
		(3)	NO			●
		(4)	NO	●		●
4NC	01J	(1)	NC			
		(2)	NC			
		(3)	NC			
		(4)	NC			
2NO+2NC	024	(1)	NC			
		(2)	NC		●	
		(3)	NO			●
		(4)	NO	●		●
2NO+2NC	03C* (Maintained only)	(1)	NC			
		(2)	NC			●
		(3)	NO			●
		(4)	NO	●		●
2NO+2NC	044*	(1)	NC			
		(2)	NC		●	
		(3)	NO			●
		(4)	NO	●		●
2NO+2NC	054	(1)	NC			
		(2)	NC		●	
		(3)	NO			●
		(4)	NO			●

Notes: ●: Contact closed Blank: Contact open  
\* There may be some overlap in the contact when switching between notches.

• **Position of contact block**

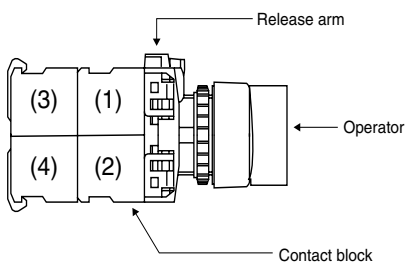

Notes: Contact block color  
NC: red  
NO: blue

Contact arrangement	Contact arrangement code	Contact operation				
		Contact block		Operator position		
		Mounting position	Type	Left	Center	Right
2NO+2NC	064	(1)	NC			
		(2)	NC		●	
		(3)	NO	●		
		(4)	NO	●		●
1NO+1NC	07F	(1)	NC			
		(2)	NO			●
		-	-	-	-	-
		-	-	-	-	-
2NO+2NC	07C* (Maintained only)	(1)	NC			
		(2)	NC			●
		(3)	NO	●		
		(4)	NO	●		
2NO+2NC	084	(1)	NC			
		(2)	NC		●	
		(3)	NO	●		
		(4)	NO	●		
2NO+2NC	094*	(1)	NC			
		(2)	NC		●	
		(3)	NO	●		
		(4)	NO			●
2NO+2NC	104	(1)	NC		●	
		(2)	NC		●	
		(3)	NO	●		●
		(4)	NO	●		●
2NO+2NC	11C* (Maintained only)	(1)	NC		●	
		(2)	NC			●
		(3)	NO	●		●
		(4)	NO	●		

# Selector Switches AR22

## • Contact arrangement code (Typical example)

Contact arrangement	Contact arrangement code	Contact operation				
		Contact block		Operator position		
		Mounting position	Type	Left	Center	Right
2NO+2NC	124*	(1)	NC		●	
		(2)	NC		●	
		(3)	NO	●		●
		(4)	NO	●		
2NO+2NC	134*	(1)	NC		●	
		(2)	NC		●	
		(3)	NO	●		●
		(4)	NO			●
3NO+1NC	14D* (Maintained only)	(1)	NO	●		
		(2)	NC		●	
		(3)	NO	●		
		(4)	NO			●
3NO+1NC	15A*	(1)	NO			●
		(2)	NC		●	
		(3)	NO			●
		(4)	NO	●		
2NO+2NC	164	(1)	NC		●	
		(2)	NC		●	
		(3)	NO	●		
		(4)	NO	●		
2NO+2NC	174*	(1)	NC		●	
		(2)	NC		●	
		(3)	NO	●		
		(4)	NO			●
2NO+2NC	184	(1)	NC		●	
		(2)	NC		●	
		(3)	NO			●
		(4)	NO			●

Notes: ●: Contact closed Blank: Contact open

\* There may be some overlap in the contact when switching between notches.

## • Position of contact block

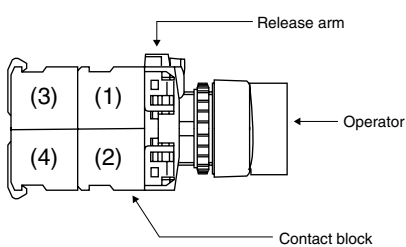



Notes: Contact block color  
NC: red  
NO: blue

Contact arrangement	Contact arrangement code	Contact operation				
		Contact block		Operator position		
		Mounting position	Type	Left	Center	Right
2NO+2NC	194	(1)	NC			●
		(2)	NC		●	
		(3)	NO	●		
		(4)	NO			●
4NO	20B	(1)	NO			●
		(2)	NO	●		
		(3)	NO			●
		(4)	NO	●		



## 4, 5-position

Operator	Contact (The following contact is only available.)	Operation	Knob color	Contact arrangement	Switch with round bezel	Switch with square bezel
					Type	Type
Knob  <small>AF94-435</small>	2NO+2NC	4-position maintained	Color code: B: Black (Standard) Color other than above are available (G: Green) (R: Red)	Replace the ■ mark by the contact arrangement code (shown below)	<b>AR22PCR-4■B</b>	<b>AR22PCY-4■B</b>
		5-position maintained			<b>AR22PCR-5■B</b>	<b>AR22PCY-5■B</b>
Lever  <small>AF94-436</small>	2NO+2NC	4-position maintained			<b>AR22WCR-4■B</b>	<b>AR22WCY-4■B</b>
		5-position maintained			<b>AR22WCR-5■B</b>	<b>AR22WCY-5■B</b>
Cylindrical knob  <small>AF94-433</small>	2NO+2NC	4-position maintained			<b>AR22RCR-4■B</b>	<b>AR22RCY-4■B</b>
		5-position maintained			<b>AR22RCR-5■B</b>	<b>AR22RCY-5■B</b>

### ● Contact arrangement code

Position	Contact arrangement	Contact arrangement code	Contact operation		Operator position
			Contact block		
			Mounting position	Type	
4-position	2NO+2NC	41C* (Maintained only)	(1)	NC	
			(2)	NC	
			(3)	NO	
			(4)	NO	
5-position	2NO+2NC	51C* (Maintained only)	(1)	NC	
			(2)	NC	
			(3)	NO	
			(4)	NO	

Notes: ●: Contact closed

\* There may be some overlap in the contact when switching between notches.

### • Position of contact block

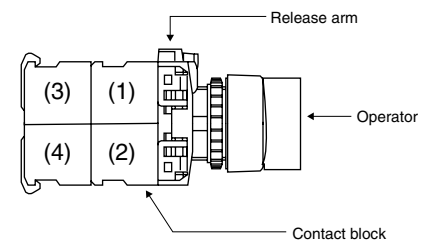

Notes: Contact block color  
 NC: red  
 NO: blue

### Operator position 4-position      5-position

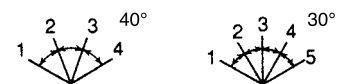





# Illuminated Selector Switches





## AR22

### ■ Illuminated selector switches

#### 2-position

Operator	Operation	Contact	LED lamp		Incandescent lamp	
			Transformer	Type	Transformer	Type
 Knob AF94-306	Maintained	1NO 1NC 1NO+1NC 2NO+2NC	Without	AR22PL-210■3□ AR22PL-201■3□ AR22PL-211■3□ AR22PL-222■3□	Without	AR22PL-210■4□ AR22PL-201■4□ AR22PL-211■4□ AR22PL-222■4□
			With	AR22PL-210■3□ AR22PL-201■3□ AR22PL-211■3□ AR22PL-220■3□	With	AR22PL-210■4□ AR22PL-201■4□ AR22PL-211■4□ AR22PL-220■4□
	 Spring return 60°	1NO 1NC 1NO+1NC 2NO	Without	AR22PL-010■3□ AR22PL-001■3□ AR22PL-011■3□ AR22PL-020■3□	Without	AR22PL-010■4□ AR22PL-001■4□ AR22PL-011■4□ AR22PL-020■4□
			With	AR22PL-010■3□ AR22PL-001■3□ AR22PL-011■3□ AR22PL-020■3□	With	AR22PL-010■4□ AR22PL-001■4□ AR22PL-011■4□ AR22PL-020■4□
 Knob with square bezel AF94-360	Maintained	1NO 1NC 1NO+1NC 2NO+2NC	Without	AR22PP-210■3□ AR22PP-201■3□ AR22PP-211■3□ AR22PP-222■3□	Without	AR22PP-210■4□ AR22PP-201■4□ AR22PP-211■4□ AR22PP-222■4□
			With	AR22PP-210■3□ AR22PP-201■3□ AR22PP-211■3□ AR22PP-220■3□	With	AR22PP-210■4□ AR22PP-201■4□ AR22PP-211■4□ AR22PP-220■4□
	 Spring return 60°	1NO 1NC 1NO+1NC 2NO	Without	AR22PP-010■3□ AR22PP-001■3□ AR22PP-011■3□ AR22PP-020■3□	Without	AR22PP-010■4□ AR22PP-001■4□ AR22PP-011■4□ AR22PP-020■4□
			With	AR22PP-010■3□ AR22PP-001■3□ AR22PP-011■3□ AR22PP-020■3□	With	AR22PP-010■4□ AR22PP-001■4□ AR22PP-011■4□ AR22PP-020■4□

#### 3-position

Operator	Operation	Contact	LED lamp		Incandescent lamp	
			Transformer	Type	Transformer	Type
 Knob AF94-306	Maintained	1NO+1NC 2NO+2NC	Without	AR22PL-311■3□ AR22PL-322■3□	Without	AR22PL-311■4□ AR22PL-322■4□
			1NO+1NC	With	AR22PL-311■3□	With
	 Spring/manual return each 45°	1NO+1NC 1NO+1NC	Without With	AR22PL-611■3□ AR22PL-611■3□	Without With	AR22PL-611■4□ AR22PL-611■4□
 Knob with square bezel AF94-360	Maintained	1NO+1NC 2NO+2NC	Without	AR22PP-311■3□ AR22PP-322■3□	Without	AR22PP-311■4□ AR22PP-322■4□
			1NO+1NC	With	AR22PP-311■3□	With
	 Spring/manual return each 45°	1NO+1NC 1NO+1NC	Without With	AR22PP-611■3□ AR22PP-611■3□	Without With	AR22PP-611■4□ AR22PP-611■4□
	 each 45°	1NO+1NC 1NO+1NC	Without With	AR22PP-711■3□ AR22PP-711■3□	Without With	AR22PP-711■4□ AR22PP-711■4□

Note: □, ■ See page 33

# Illuminated Selector Switches AR22

• Replace the ■ mark by the following lamp voltage code

Transformer	Voltage	Code	
		LED	Incandescent
Without	5V AC/DC	—	5
	6V DC	6	—
	6V AC	A	—
	12V AC/DC	B	—
	15V AC/DC	C	C
	20V AC/DC	—	D
24V AC/DC	E	E	—
With	100-110V AC	H	H
	115-127V AC	L	L
	200-220V AC	M	M
	230-254V AC	Q	Q
	350-380V AC	S	S
	400-440V AC	T	T
	480V AC	V	V
	500-550V AC	W	W

• Replace the □ mark by the following knob color code

Color	Green	Red	White	Blue	Yellow	Orange
Code	G	R	W	S	Y	A

• Up to 4-contact of contact arrangement can be made.  
Available numbers of contacts are as follow.

No. of position	Operation	Without transformer	With transformer
2-position	Maintained	4-contact	3-contact
	Spring return	3-contact	2-contact
3-position	Maintained	4-contact	3-contact
	Spring/manual return	3-contact	2-contact

### ● Contact arrangement and operator position

#### 2-position

Transformer	Contact arrangement	Contact block		Operator position	
		Mounting position	Type	Left	Right
With/without	1NO	(1)	NO	—	●
With/without	1NC	(1)	NC	●	—
Without	1NO+1NC	(1)	NO	—	●
		(2)	NC	●	—
With	1NO+1NC	(1)	NC	●	—
		(2)	NO	—	●
With/without	2NO	(1)	NO	—	●
		(2)	NO	—	●
Without	2NO+2NC *1	(1)	NO	—	●
		(2)	NC	●	—
		(3)	NO	—	●
		(4)	NC	●	—

Notes: \*1: AR22PL-2, AR22PP-2

●: Contact closed, —: Contact open

#### 3-position

Transformer	Contact arrangement	Contact block		Operator position		
		Mounting position	Type	Left	Center	Right
Without	1NO+1NC *1	(1)	NO	●	—	—
		(2)	NC	—	—	●
	1NO+1NC *2	(1)	NO	—	—	●
		(2)	NC	●	—	—
	2NO+2NC *3	(1)	NO	●	—	—
		(2)	NC	—	—	●
(3)	NO	●	—	—	—	
(4)	NC	—	—	—	●	
With	1NO+1NC *1	(1)	NC	—	—	●
		(2)	NO	●	—	—
	1NO+1NC *2	(1)	NC	●	—	—
		(2)	NO	—	—	●

Notes: \*1: AR22PL-3, 6 AR22PP-3, 6 \*3: AR22PL-3 AR22PP-3

\*2: AR22PL-7, AR22PP-7

●: Contact closed, —: Contact open

### ● Position of contact block

Without transformer

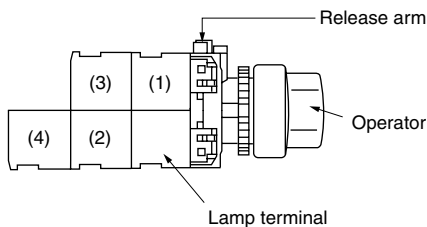

With transformer

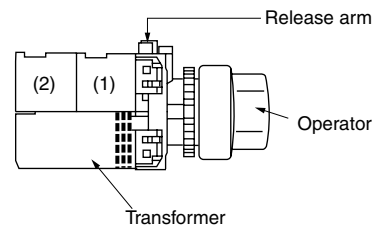

# Pilot Lights DR22

## ■ Pilot lights/standard

Lens	Transformer	LED lamp		Incandescent lamp	
		Lamp voltage	Type	Lamp voltage	Type
Dome  <small>AF94-333</small>	Without	6V AC 6V DC 12V AC/DC 24V AC/DC	DR22D0L-A3□ DR22D0L-63□ DR22D0L-B3□ DR22D0L-E3□	5.5V AC/DC — 15V AC/DC 24V AC/DC	DR22D0L-54□ — DR22D0L-C4□ DR22D0L-E4□
	With	100–110V AC 200–220V AC	DR22D0L-H3□ DR22D0L-M3□	100–110V AC 200–220V AC	DR22D0L-H4□ DR22D0L-M4□
Extended round  <small>AF94-332</small>	Without	6V AC 6V DC 12V AC/DC 24V AC/DC	DR22E3L-A3□ DR22E3L-63□ DR22E3L-B3□ DR22E3L-E3□	5.5V AC/DC — 15V AC/DC 24V AC/DC	DR22E3L-54□ — DR22E3L-C4□ DR22E3L-E4□
	With	100–110V AC 200–220V AC	DR22E3L-H3□ DR22E3L-M3□	100–110V AC 200–220V AC	DR22E3L-H4□ DR22E3L-M4□
Faceted  <small>AF96-189</small>	Without	6V AC 6V DC 12V AC/DC 24V AC/DC	DR22K0L-A3□ DR22K0L-63□ DR22K0L-B3□ DR22K0L-E3□	5.5V AC/DC — 15V AC/DC 24V AC/DC	DR22K0L-54□ — DR22K0L-C4□ DR22K0L-E4□
	With	100–110V AC 200–220V AC	DR22K0L-H3□ DR22K0L-M3□	100–110V AC 200–220V AC	DR22K0L-H4□ DR22K0L-M4□
Flush square  <small>AF94-330</small>	Without	6V AC 6V DC 12V AC/DC 24V AC/DC	DR22F3M-A3□ DR22F3M-63□ DR22F3M-B3□ DR22F3M-E3□	5.5V AC/DC — 15V AC/DC 24V AC/DC	DR22F3M-54□ — DR22F3M-C4□ DR22F3M-E4□
	With	100–110V AC 200–220V AC	DR22F3M-H3□ DR22F3M-M3□	100–110V AC 200–220V AC	DR22F3M-H4□ DR22F3M-M4□
Flush square (Transparent lens)  <small>AF94-443</small>	Without	6V AC 6V DC 12V AC/DC 24V AC/DC	DR22F4M-A3□ DR22F4M-63□ DR22F4M-B3□ DR22F4M-E3□	5.5V AC/DC — 15V AC/DC 24V AC/DC	DR22F4M-54□ — DR22F4M-C4□ DR22F4M-E4□
	With	100–110V AC 200–220V AC	DR22F4M-H3□ DR22F4M-M3□	100–110V AC 200–220V AC	DR22F4M-H4□ DR22F4M-M4□
Flush square (12mm high frame)  <small>AF95-685</small>	Without	6V AC 6V DC 12V AC/DC 24V AC/DC	DR22F5M-A3□ DR22F5M-63□ DR22F5M-B3□ DR22F5M-E3□	5.5V AC/DC — 15V AC/DC 24V AC/DC	DR22F5M-54□ — DR22F5M-C4□ DR22F5M-E4□
	With	100–110V AC 200–220V AC	DR22F5M-H3□ DR22F5M-E3□	100–110V AC 200–220V AC	DR22F5M-H4□ DR22F5M-M4□
Extended square  <small>AF94-380</small>	Without	6V AC 6V DC 12V AC/DC 24V AC/DC	DR22E3M-A3□ DR22E3M-63□ DR22E3M-B3□ DR22E3M-E3□	5.5V AC/DC — 15V AC/DC 24V AC/DC	DR22E3M-54□ — DR22E3M-C4□ DR22E3M-E4□
	With	100–110V AC 200–220V AC	DR22E3M-H3□ DR22E3M-M3□	100–110V AC 200–220V AC	DR22E3M-H4□ DR22E3M-M4□
Flush rectangular  <small>AF96-237</small>	Without	6V AC 6V DC 12V AC/DC 24V AC/DC	DR22E3N-A3□ DR22E3N-63□ DR22E3N-B3□ DR22E3N-E3□	5.5V AC/DC — 15V AC/DC 24V AC/DC	DR22E3N-54□ — DR22E3N-C4□ DR22E3N-E4□
	With	100–110V AC 200–220V AC	DR22E3N-H3□ DR22E3N-M3□	100–110V AC 200–220V AC	DR22E3N-H4□ DR22E3N-M4□
Extended round with square bezel  <small>AF94-331</small>	Without	6V AC 6V DC 12V AC/DC 24V AC/DC	DR22E3P-A3□ DR22E3P-63□ DR22E3P-B3□ DR22E3P-E3□	5.5V AC/DC — 15V AC/DC 24V AC/DC	DR22E3P-54□ — DR22E3P-C4□ DR22E3P-E4□
	With	100–110V AC 200–220V AC	DR22E3P-H3□ DR22E3P-M3□	100–110V AC 200–220V AC	DR22E3P-H4□ DR22E3P-M4□

Note: □ See page 37

■ Pilot lights/short-body without transformer

Lens	LED lamp		Incandescent lamp	
	Lamp voltage	Type	Lamp voltage	Type
 AF98-88	5.5V AC/DC	—	5.5V AC/DC	DR22D0L-58□
	6V AC	DR22D0L-A9□	6V AC	—
	6V DC	DR22D0L-69□	6V DC	—
	12V AC/DC	DR22D0L-B9□	15V AC/DC	DR22D0L-C8□
	24V AC/DC	DR22D0L-E9□	24V AC/DC	DR22D0L-E8□
 AF98-90	5.5V AC/DC	—	5.5V AC/DC	DR22E3L-58□
	6V AC	DR22E3L-A9□	6V AC	—
	6V DC	DR22E3L-69□	6V DC	—
	12V AC/DC	DR22E3L-B9□	15V AC/DC	DR22E3L-C8□
	24V AC/DC	DR22E3L-E9□	24V AC/DC	DR22E3L-E8□
 AF98-89	5.5V AC/DC	—	5.5V AC/DC	DR22K0L-58□
	6V AC	DR22K0L-A9□	6V AC	—
	6V DC	DR22K0L-69□	6V DC	—
	12V AC/DC	DR22K0L-B9□	15V AC/DC	DR22K0L-C8□
	24V AC/DC	DR22K0L-E9□	24V AC/DC	DR22K0L-E8□
 AF98-92	5.5V AC/DC	—	5.5V AC/DC	DR22F3M-58□
	6V AC	DR22F3M-A9□	6V AC	—
	6V DC	DR22F3M-69□	6V DC	—
	12V AC/DC	DR22F3M-B9□	15V AC/DC	DR22F3M-C8□
	24V AC/DC	DR22F3M-E9□	24V AC/DC	DR22F3M-E8□
 AF98-92	5.5V AC/DC	—	5.5V AC/DC	DR22F4M-58□
	6V AC	DR22F4M-A9□	6V AC	—
	6V DC	DR22F4M-69□	6V DC	—
	12V AC/DC	DR22F4M-B9□	15V AC/DC	DR22F4M-C8□
	24V AC/DC	DR22F4M-E9□	24V AC/DC	DR22F4M-E8□
 AF98-94	5.5V AC/DC	—	5.5V AC/DC	DR22F5M-58□
	6V AC	DR22F5M-A9□	6V AC	—
	6V DC	DR22F5M-69□	6V DC	—
	12V AC/DC	DR22F5M-B9□	15V AC/DC	DR22F5M-C8□
	24V AC/DC	DR22F5M-E9□	24V AC/DC	DR22F5M-E8□
 AF98-93	5.5V AC/DC	—	5.5V AC/DC	DR22E3M-58□
	6V AC	DR22E3M-A9□	6V AC	—
	6V DC	DR22E3M-69□	6V DC	—
	12V AC/DC	DR22E3M-B9□	15V AC/DC	DR22E3M-C8□
	24V AC/DC	DR22E3M-E9□	24V AC/DC	DR22E3M-E8□
 KK02-234B	5.5V AC/DC	—	5.5V AC/DC	DR22E3N-58□
	6V AC	DR22E3N-A9□	6V AC	—
	6V DC	DR22E3N-69□	6V DC	—
	12V AC/DC	DR22E3N-B9□	15V AC/DC	DR22E3N-C8□
	24V AC/DC	DR22E3N-E9□	24V AC/DC	DR22E3N-E8□
 AF98-91	5.5V AC/DC	—	5.5V AC/DC	DR22E3P-58□
	6V AC	DR22E3P-A9□	6V AC	—
	6V DC	DR22E3P-69□	6V DC	—
	12V AC/DC	DR22E3P-B9□	15V AC/DC	DR22E3P-C8□
	24V AC/DC	DR22E3P-E9□	24V AC/DC	DR22E3P-E8□

Note: □ See page 37

# Pilot Lights DR22

## ■ Pilot lights/short-body with transformer

Lens	LED lamp		Incandescent lamp	
	Lamp voltage	Type	Lamp voltage	Type
Dome  <small>AF97-137</small>	100–110V AC	<b>DR22D0L-H9</b> □	100–110V AC	<b>DR22D0L-H8</b> □
	200–220V AC	<b>DR22D0L-M9</b> □	200–220V AC	<b>DR22D0L-M8</b> □
Extended round  <small>AF97-138</small>	100–110V AC	<b>DR22E3L-H9</b> □	100–110V AC	<b>DR22E3L-H8</b> □
	200–220V AC	<b>DR22E3L-M9</b> □	200–220V AC	<b>DR22E3L-M8</b> □
Faceted  <small>KK02-130A</small>	100–110V AC	<b>DR22K0L-H9</b> □	100–110V AC	<b>DR22K0L-H8</b> □
	200–220V AC	<b>DR22K0L-M9</b> □	200–220V AC	<b>DR22K0L-M8</b> □
Flush square  <small>AF97-134</small>	100–110V AC	<b>DR22F3M-H9</b> □	100–110V AC	<b>DR22F3M-H8</b> □
	200–220V AC	<b>DR22F3M-M9</b> □	200–220V AC	<b>DR22F3M-M8</b> □
Flush square (Transparent lens)  <small>AF97-133</small>	100–110V AC	<b>DR22F4M-H9</b> □	100–110V AC	<b>DR22F4M-H8</b> □
	200–220V AC	<b>DR22F4M-M9</b> □	200–220V AC	<b>DR22F4M-M8</b> □
Flush square (12mm high frame)  <small>AF97-136</small>	100–110V AC	<b>DR22F5M-H9</b> □	100–110V AC	<b>DR22F5M-H8</b> □
	200–220V AC	<b>DR22F5M-M9</b> □	200–220V AC	<b>DR22F5M-M8</b> □
Extended square  <small>KK02-134A</small>	100–110V AC	<b>DR22E3M-H9</b> □	100–110V AC	<b>DR22E3M-H8</b> □
	200–220V AC	<b>DR22E3M-M9</b> □	200–220V AC	<b>DR22E3M-M8</b> □
Flush rectangular  <small>KK02-235B</small>	100–110V AC	<b>DR22E3N-H9</b> □	100–110V AC	<b>DR22E3N-H8</b> □
	200–220V AC	<b>DR22E3N-M9</b> □	200–220V AC	<b>DR22E3N-M8</b> □
Extended round with square bezel  <small>AF97-135</small>	100–110V AC	<b>DR22E3P-H9</b> □	100–110V AC	<b>DR22E3P-H8</b> □
	200–220V AC	<b>DR22E3P-M9</b> □	200–220V AC	<b>DR22E3P-M8</b> □

Note: □ See page 37

• **Lens color**

Replace the □ mark by the following lens color code

Color	Green	Red	White	Blue	Yellow	Orange
Code	G	R	W	S	Y	A



• **Lamp voltage**

Available lamp voltage are as follow.

Description	Voltage	Code		Short-body type	
		Standard type		LED	Incandescent
Without transformer	5.5V AC/DC	–	54	–	58
	6V AC	A3	–	A9	–
	6V DC	63	–	69	–
	12V AC/DC	B3	–	B9	–
	15V AC/DC	C3	C4	C9	C8
	20V AC/DC	–	D4	–	D8
	24V AC/DC	E3	E4	E9	E8
With transformer	100-110V AC	H3	H4	H9	H8
	115-127V AC	L3	L4	L9	L8
	200-220V AC	M3	M4	M9	M8
	230-254V AC	Q3	Q4	–	–
	350-380V AC	S3	S4	–	–
	400-440V AC	T3	T4	–	–
	480V AC	V3	V4	–	–
500-550V AC	W3	W4	–	–	
With resistor unit	110V DC	H7	–	–	–

# Joy Stick Selector Switches AR22

## ■ Joy stick selector switches

Handle	Terminal	Operating directions	Contact arrangement	Type	
				Manual return	Spring return
Ball type without lock    <small>AF97-49</small>	Screw	↑ ↓	1NO × 2	<b>AR22A0N-A0A0B</b>	<b>AR22A5N-A0A0B</b>
			1NO + 1NC × 2	<b>AR22A0N-1010B</b>	<b>AR22A5N-1010B</b>
		↕	1NO × 4	<b>AR22A0N-AAAAB</b>	<b>AR22A5N-AAAAB</b>
			1NO + 1NC × 4	<b>AR22A0N-1111B</b>	<b>AR22A5N-1111B</b>
	Solder/tab	↑ ↓	1NO + 1NC × 2	<b>AR22A0H-1010B</b>	<b>AR22A5H-1010B</b>
			2NO + 2NC × 2	<b>AR22A0H-2020B</b>	<b>AR22A5H-2020B</b>
↕	↑ ↓	1NO + 1NC × 4	<b>AR22A0H-1111B</b>	<b>AR22A5H-1111B</b>	
		2NO + 2NC × 4	<b>AR22A0H-2222B</b>	<b>AR22A5H-2222B</b>	
Ball type with lock    <small>AF97-45</small>	Screw	↑ ↓	1NO × 2	<b>AR22A1N-A0A0B</b>	<b>AR22A6N-A0A0B</b>
			1NO + 1NC × 2	<b>AR22A1N-1010B</b>	<b>AR22A6N-1010B</b>
		↕	1NO × 4	<b>AR22A1N-AAAAB</b>	<b>AR22A6N-AAAAB</b>
			1NO + 1NC × 4	<b>AR22A1N-1111B</b>	<b>AR22A6N-1111B</b>
	Solder/tab	↑ ↓	1NO + 1NC × 2	<b>AR22A1H-1010B</b>	<b>AR22A6H-1010B</b>
			2NO + 2NC × 2	<b>AR22A1H-2020B</b>	<b>AR22A6H-2020B</b>
↕	↑ ↓	1NO + 1NC × 4	<b>AR22A1H-1111B</b>	<b>AR22A6H-1111B</b>	
		2NO + 2NC × 4	<b>AR22A1H-2222B</b>	<b>AR22A6H-2222B</b>	
Rubber cap type without lock    <small>AF97-56</small>	Screw	↑ ↓	1NO × 2	<b>AR22A2N-A0A0B</b>	<b>AR22A7N-A0A0B</b>
			1NO + 1NC × 2	<b>AR22A2N-1010B</b>	<b>AR22A7N-1010B</b>
		↕	1NO × 4	<b>AR22A2N-AAAAB</b>	<b>AR22A7N-AAAAB</b>
			1NO + 1NC × 4	<b>AR22A2N-1111B</b>	<b>AR22A7N-1111B</b>
	Solder/tab	↑ ↓	1NO + 1NC × 2	<b>AR22A2H-1010B</b>	<b>AR22A7H-1010B</b>
			2NO + 2NC × 2	<b>AR22A2H-2020B</b>	<b>AR22A7H-2020B</b>
↕	↑ ↓	1NO + 1NC × 4	<b>AR22A2H-1111B</b>	<b>AR22A7H-1111B</b>	
		2NO + 2NC × 4	<b>AR22A2H-2222B</b>	<b>AR22A7H-2222B</b>	

### • Operating direction

- Directions other than those shown in the table above can be provided.
- For types AR22A□N-①②③④ B, designate the contact arrangement codes for the necessary operating directions (①: Upper, ②: Right, ③: Lower, ④: Left). Designate "0" for unnecessary directions.

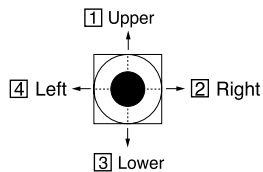



### • Contact arrangement

Contact arrangement		-	1NO	1NC	1NO+1NC	2NO	2NC	2NO+2NC
Manual return	Screw	0	A	B	1	D	E	-
Spring return	Solder/Tab	0	-	-	1	-	-	2

- Spring/manual return are also available, contact FUJI.



### ■ Buzzers

Sound	Description	Transformer	Operating voltage	Type
Electronic sound  AF96-377	<ul style="list-style-type: none"> <li>• LED operation indicator (Red)</li> <li>• Intermittent/continuous sound selection</li> <li>• Sound level: 90dB (0.1m) 70dB (1m)</li> </ul>	Without	6V AC 6V DC 12 to 24V AC/DC 35 to 48V AC/DC	<b>DR22B5-AB</b> <b>DR22B5-6B</b> <b>DR22B5-EB</b> <b>DR22B5-FB</b>
		With	100 to 110V AC 200 to 220V AC	<b>DR22B5-HB</b> <b>DR22B5-MB</b>
		With resistor unit	100 to 110V DC	<b>DR22B5-1B</b>
Magnetic sound  AF96-376	<ul style="list-style-type: none"> <li>• Sound volume adjustment</li> <li>• Sound level: 80 to 90dB (0.1m) 60 to 70dB (1m)</li> </ul>	Without	24V AC/DC	<b>DR22B3-EB</b>
		With	100 to 110V AC 200 to 220V AC	<b>DR22B3-HB</b> <b>DR22B3-MB</b>
Electronic sound (IP54)  AF96-244	<ul style="list-style-type: none"> <li>• Intermittent/continuous sound selection</li> <li>• Sound level: 80dB (0.1m) 60dB (1m)</li> </ul>	Without	6V AC 6V DC 12 to 24V AC/DC 35 to 48V AC/DC	<b>DR22B8-AB</b> <b>DR22B8-6B</b> <b>DR22B8-EB</b> <b>DR22B8-FB</b>
		With	100 to 110V AC 200 to 220V AC	<b>DR22B8-HB</b> <b>DR22B8-MB</b>
		With resistor unit	100 to 110V DC	<b>DR22B8-1B</b>

Notes: • Intermittent/continuous sound selection (DR22B5, B8)  
See the "Short-circuit terminal" in the dimensions diagram on the 49 page, and select as follows:  
• Short-circuit terminal mounted → Intermittent sound  
• Short-circuit terminal not mounted → Continuous sound

• Sound volume adjustment (DR22B3)  
Use a flat-bladed screwdriver with a narrow tip to gently turn "Control knob" shown in the dimensions diagram on the 49 page, as follows.  
• Clockwise → Increase sound pressure  
• Counterclockwise → Decrease sound pressure

# Pushbuttons/Selectors/Pilot Lights/Buzzers

## AR22 and DR22

### Dimensions

#### ■ Dimensions, mm

#### • Illuminated pushbutton switches

#### Flush/Extended

With transformer

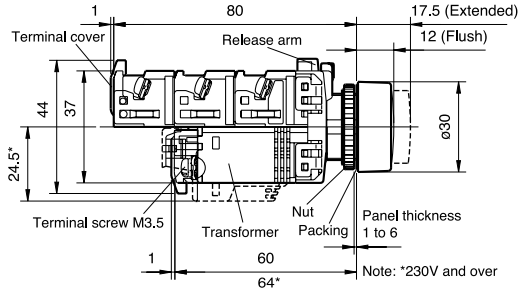

AR22F0L, F5L  
AR22E0L, E5L

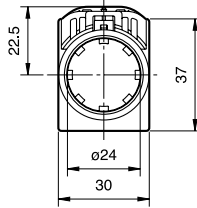

AR22F0M, F5M  
AR22E0M, E5M

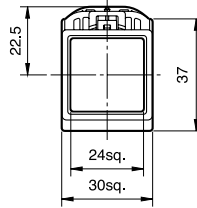

AR22F0P, F5P  
AR22E0P, E5P

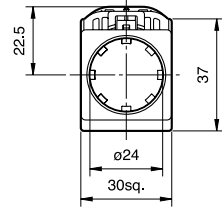

Without transformer

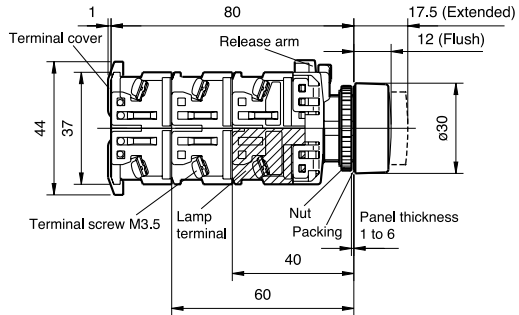

#### Mushroom (40mm dia.)

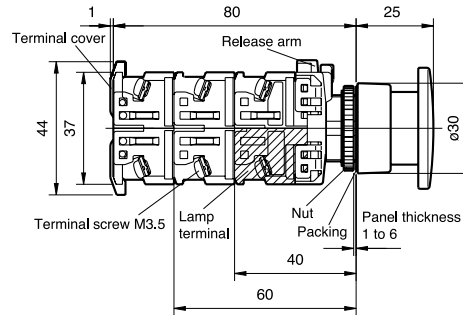

AR22M0L, M5L

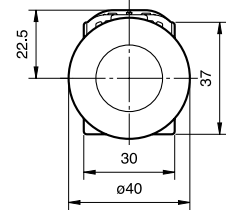

#### Mushroom (29mm dia.)

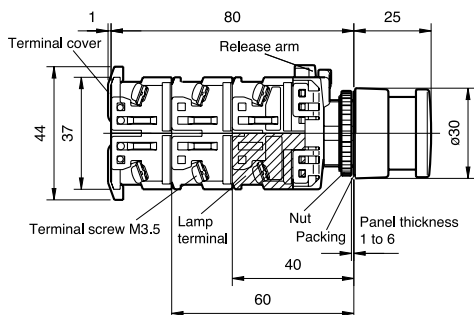

AR22M4L, M9L

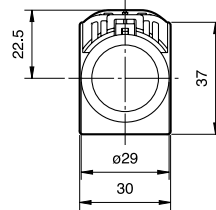

AR22M4P

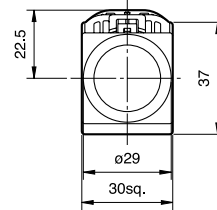

#### Extended with full guard

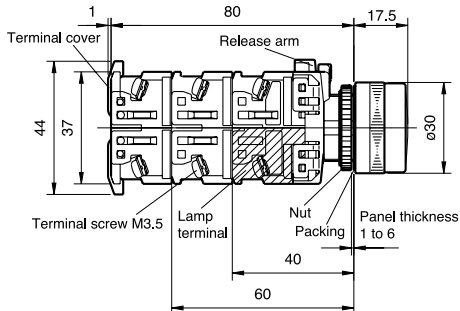

AR22G4L, G9L  
AR22G1L, G6L

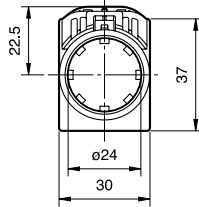

#### Extended with full guard (with openings)

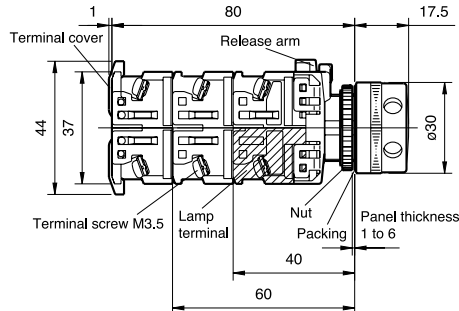

AR22G2L, G7L

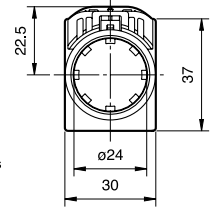

#### Push-lock, turn-reset

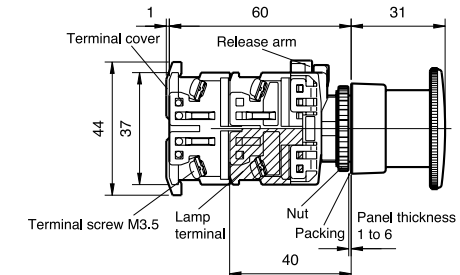

AR22V5L

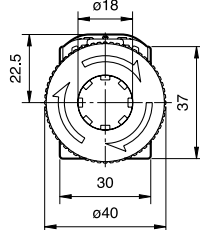

# Pushbuttons/Selectors/Pilot Lights/Buzzers AR22 and DR22 Dimensions

## ■ Dimensions, mm • Pushbutton switches

### Flush/Extended

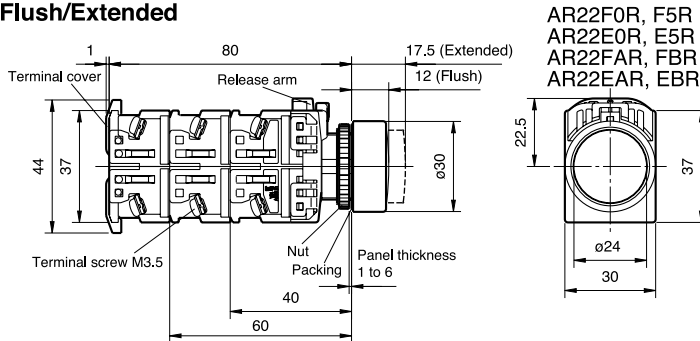

### Mushroom (40mm dia.)

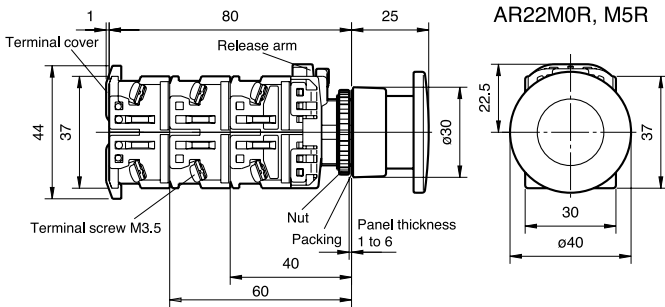

### Flush/Extended with full guard

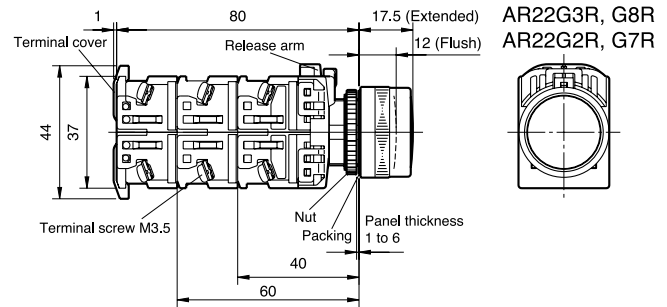

### Mushroom (29mm dia.)

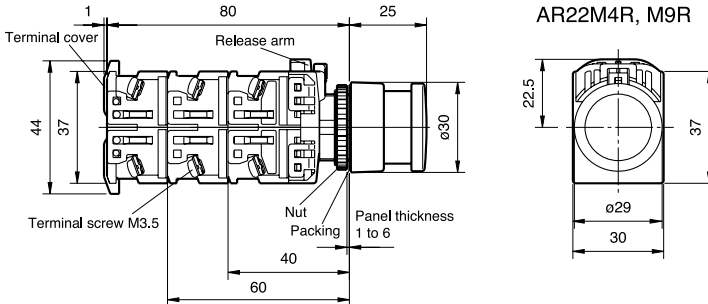

### AR22M4Y

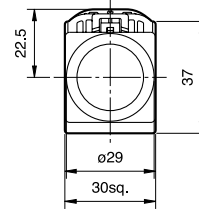

### Extended with half guard

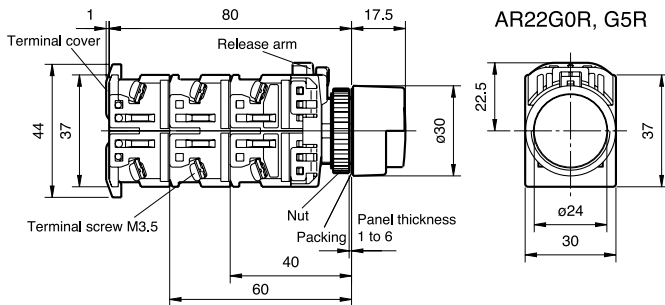

### Mushroom with full guard (40mm dia.)

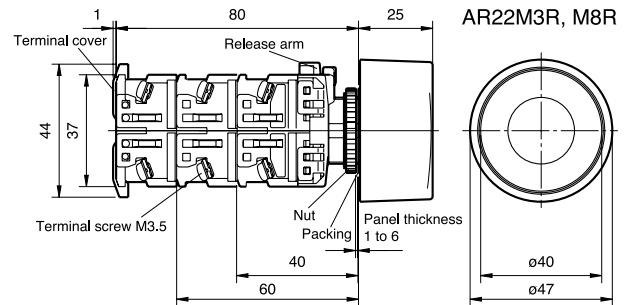

### Pushbutton with selector ring

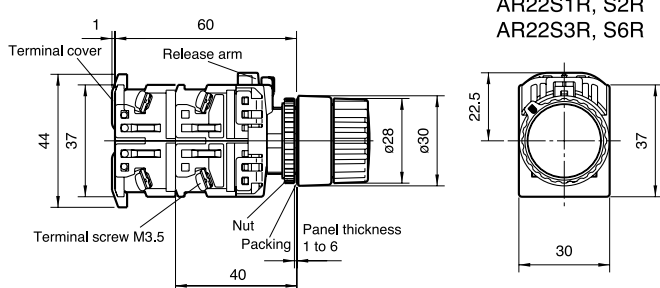

### Push-lock, turn-reset

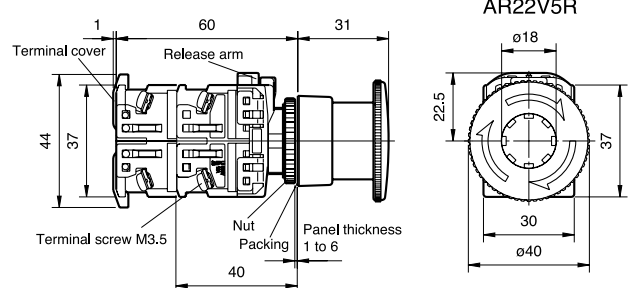

# Pushbuttons/Selectors/Pilot Lights/Buzzers

## AR22 and DR22

### Dimensions

#### ■ Dimensions, mm

#### •Emergency stop pushbutton switches

##### Push-lock, turn-reset (40mm dia.)

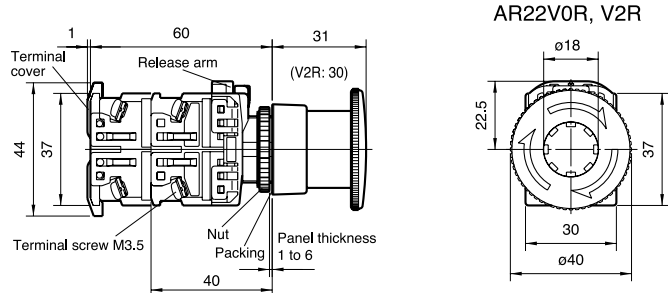

##### Push-lock, turn-reset (29mm dia.)

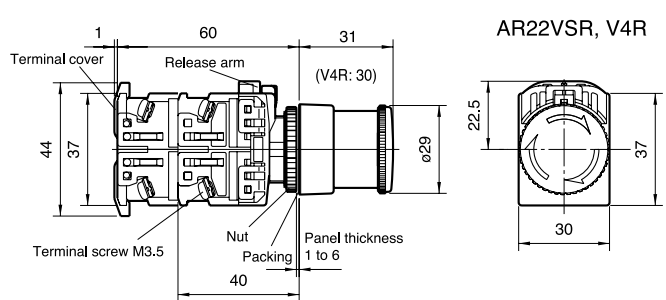

##### Key release push-lock, turn-reset (40mm dia.)

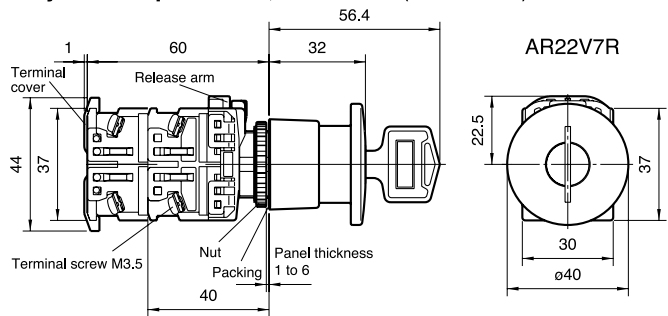

##### Push-lock, pull-reset (35mm dia.)

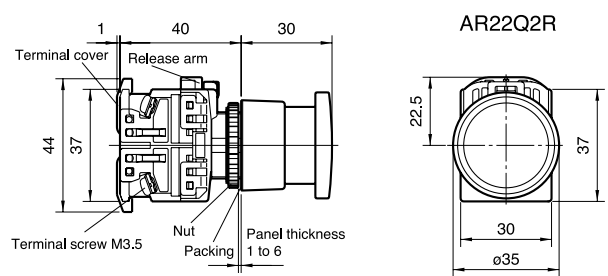

##### Unibody push-lock, turn-reset (40mm dia.)

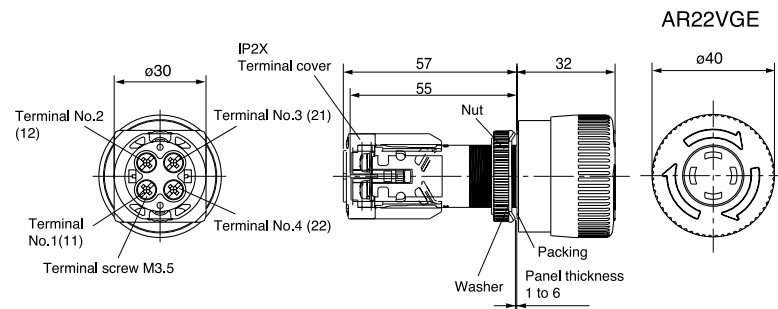

#### Wiring diagrams

1NC

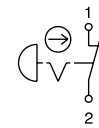

2NC

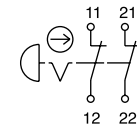

1NO+1NC

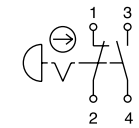

Note: Terminal No. shown in ( ) are for contact arrangement 2NC.

# Pushbuttons/Selectors/Pilot Lights/Buzzers AR22 and DR22 Dimensions

■ Dimensions, mm

•Emergency stop illuminated pushbutton switches

**Push-lock, turn-reset (40mm dia.)**

With transformer

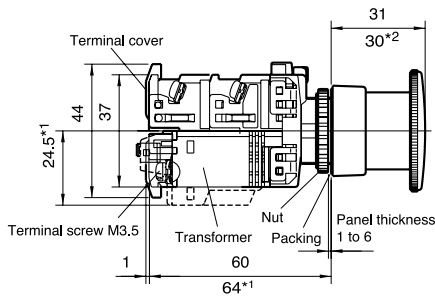

AR22V0L, V2L  
AR22VDL, VAL

Without transformer

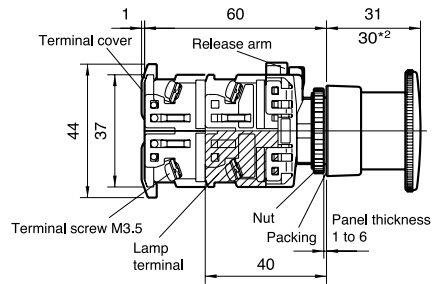

Note: \*1 230V and over  
\*2 AR22V2L and VAL types only

**Push-lock, turn-reset (29mm dia.)**

Without transformer

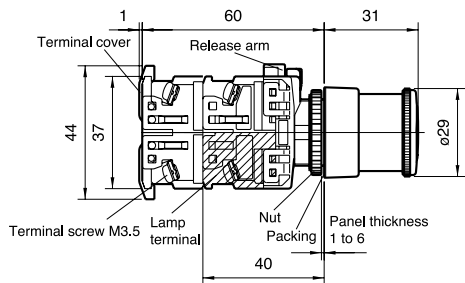

AR22VSL

**Unibody push-lock, turn-reset (40mm dia.)**

Without transformer

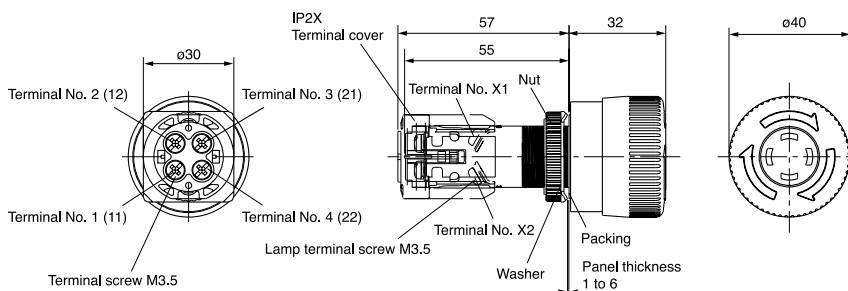

AR22VGF

Wiring diagrams

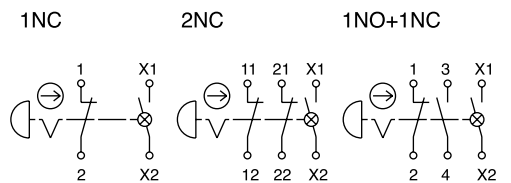

Note: Terminal No. shown in ( ) are for contact arrangement 2NC.

# Pushbuttons/Selectors/Pilot Lights/Buzzers

## AR22 and DR22

### Dimensions

#### ■ Dimensions, mm

#### • Selector switches

#### Knob

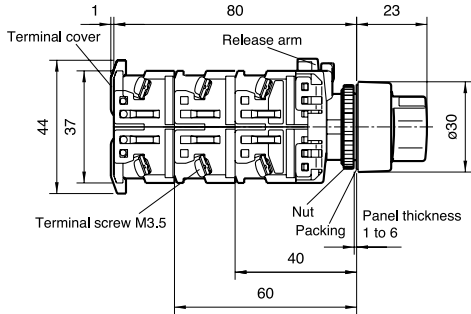

AR22PR, PCR

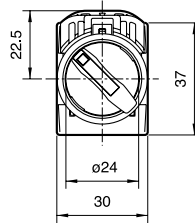

AR22PY, PCY

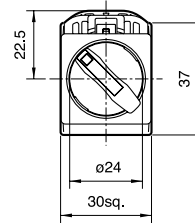

#### Lever

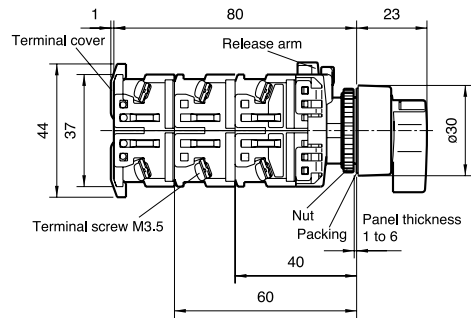

AR22WR, WCR

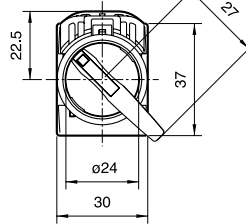

AR22WY, WCY

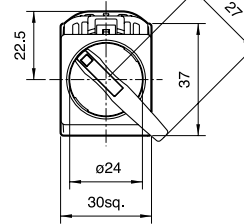

#### Cylindrical knob

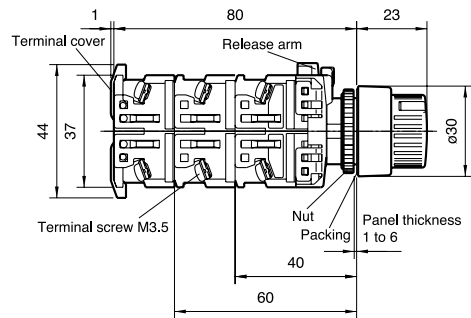

AR22RR, RCR

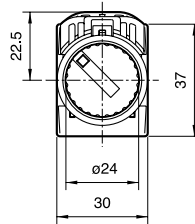

AR22RY, RCY

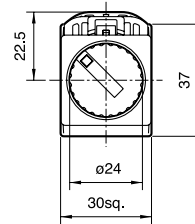

#### Key

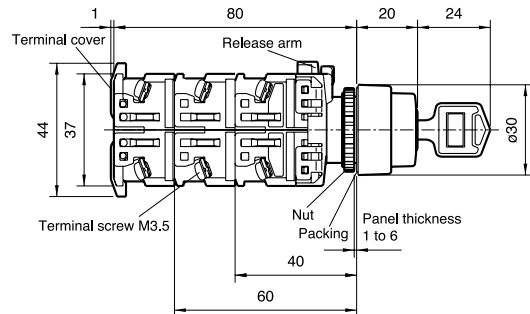

AR22JR, JCR  
AR22JAR

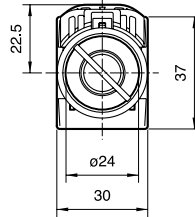

AR22JY, JCY

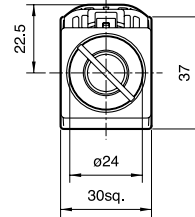

# Pushbuttons/Selectors/Pilot Lights/Buzzers AR22 and DR22 Dimensions

## ■ Dimensions, mm •Illuminated selector switches

With transformer

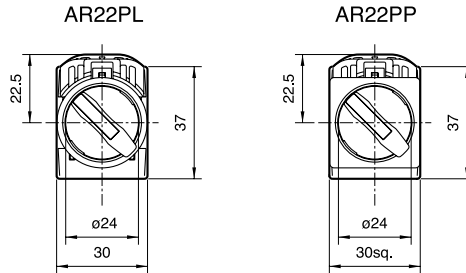
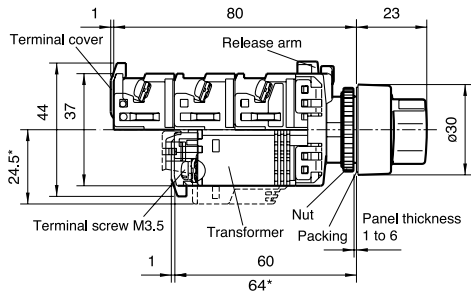

Note: \* 230V and over

Without transformer

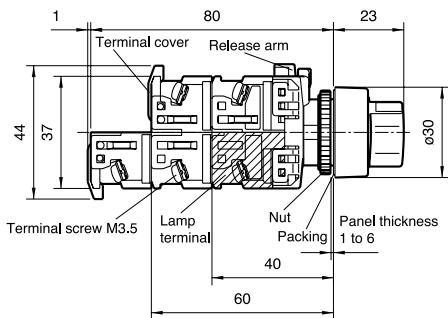

## •Pilot lights

### Dome

With transformer, with resistor unit

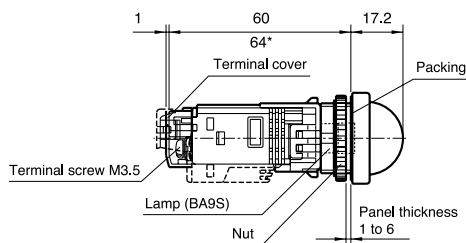

DR22D0L

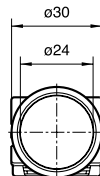

Without transformer

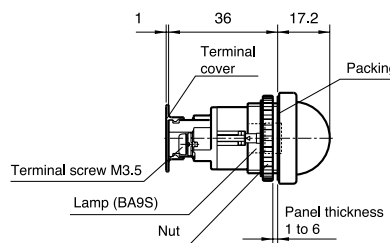

DR22D0L

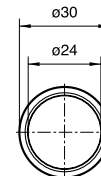

Short body/with transformer

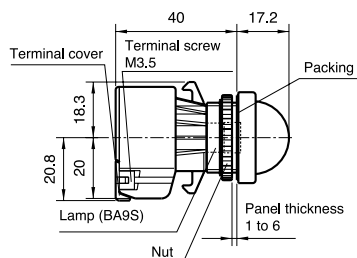

DR22D0L

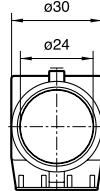

Short body/without transformer

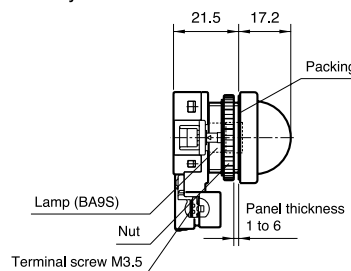

DR22D0L

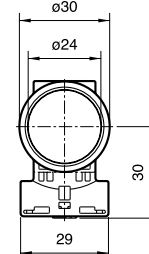

Note: \* Except for the types 110V AC, 127V AC and 220V AC.

# Pushbuttons/Selectors/Pilot Lights/Buzzers

## AR22 and DR22

### Dimensions

#### ■ Dimensions, mm

#### • Pilot lights

##### Extended

With transformer, with resistor unit

Without transformer

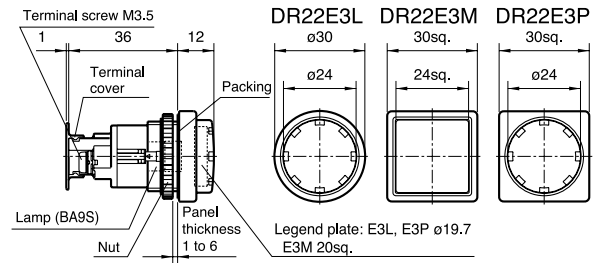
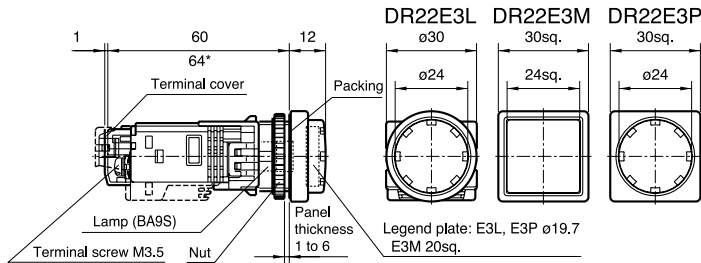

Short body/with transformer

Short body/without transformer

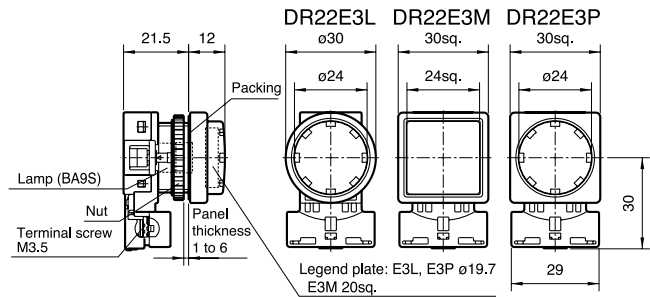
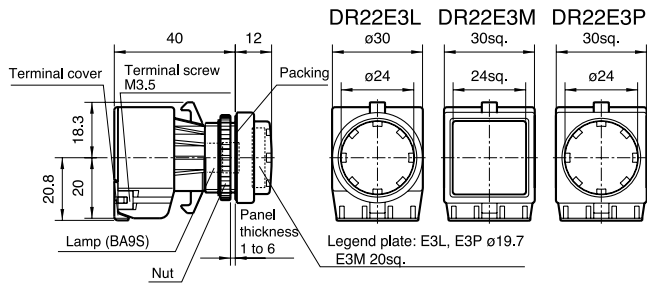

Note: \* Except for the types 110V AC, 127V AC and 220V AC.

##### Faceted

With transformer, with resistor unit

Without transformer

DR22K0L

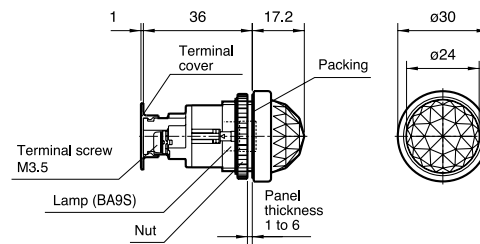
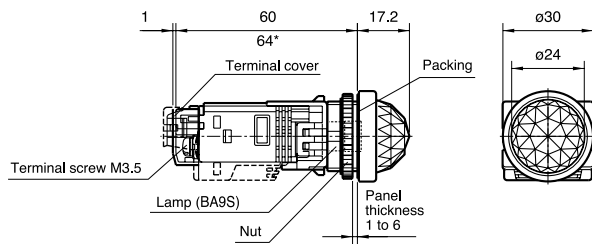

Short body/with transformer

Short body/without transformer

DR22K0L

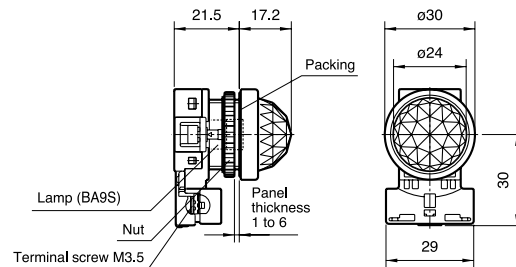
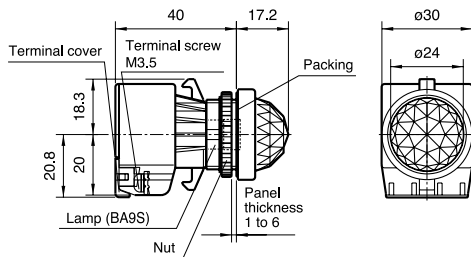

Note: \* Except for the types 110V AC, 127V AC and 220V AC.



# Pushbuttons/Selectors/Pilot Lights/Buzzers AR22 and DR22 Dimensions

## ■ Dimensions, mm •Pilot lights

### Flush

With transformer, with resistor unit DR22F3M, F4M

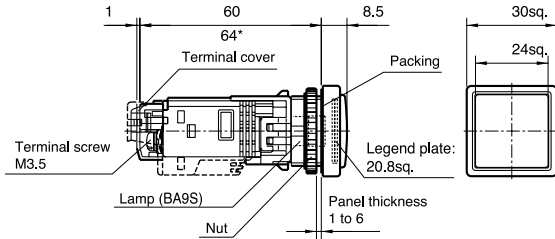

Without transformer DR22F3M, F4M

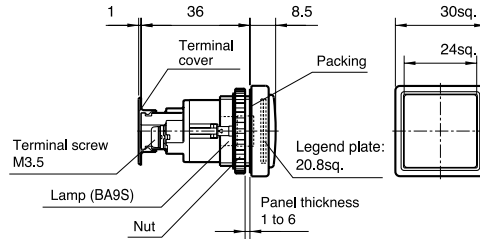

Short body/with transformer DR22F3M, F4M

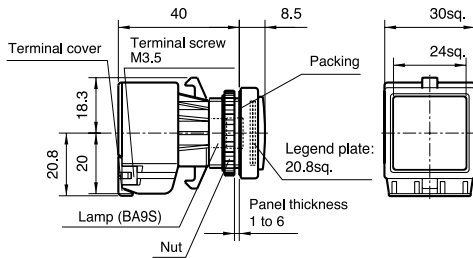

Short body/without transformer DR22F3M, F4M

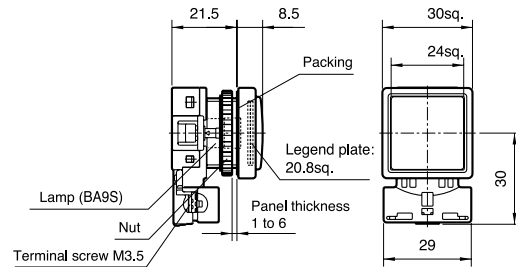

Note: \* Except for the types 110V AC, 127V AC and 220V AC.

### Flush (12mm high frame)

With transformer, with resistor unit DR22F5M

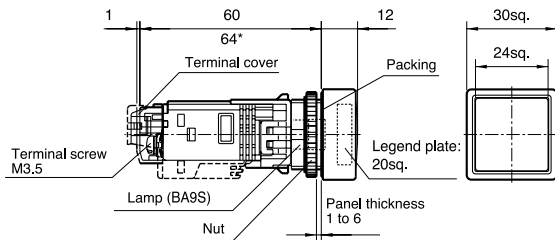

Without transformer DR22F5M

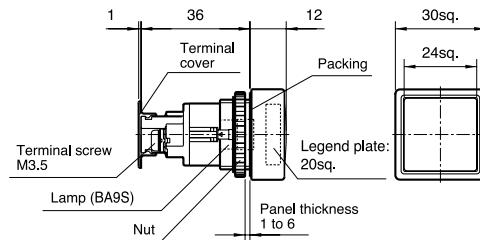

Short body/with transformer DR22F5M

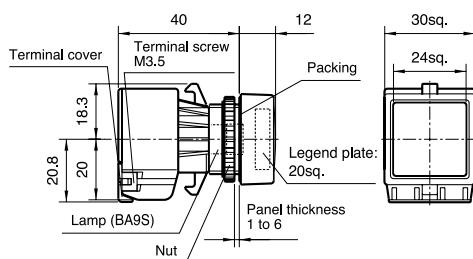

Short body/without transformer DR22F5M

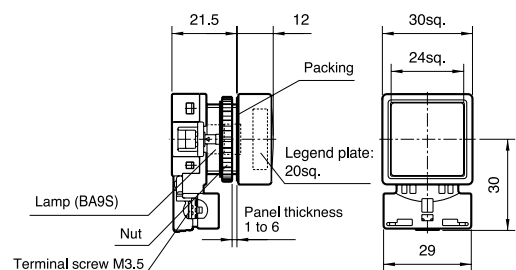

Note: \* Except for the types 110V AC, 127V AC and 220V AC.

# Pushbuttons/Selectors/Pilot Lights/Buzzers

## AR22 and DR22

### Dimensions

#### ■ Dimensions, mm

#### •Pilot lights

##### Flush rectangular

With transformer, with resistor unit

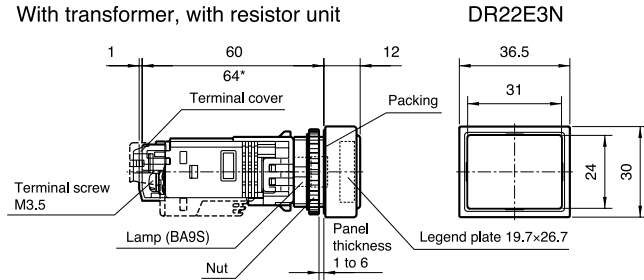

Without transformer

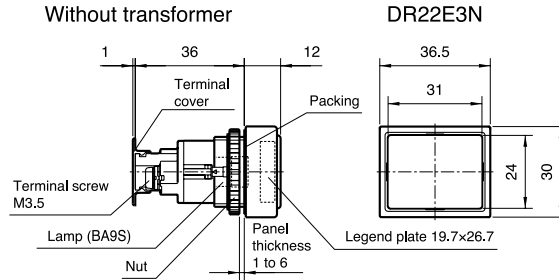

Short body/with transformer

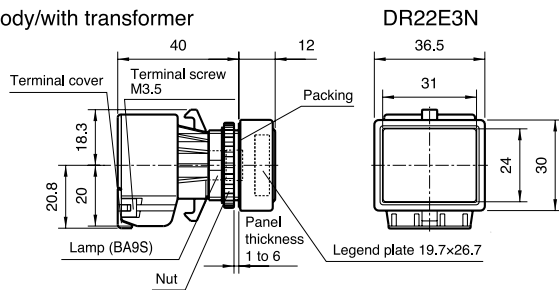

Short body/without transformer

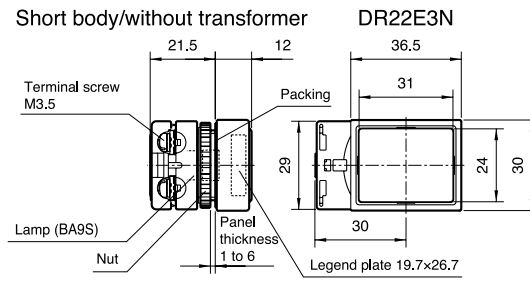

Note: \* Except for the types 110V AC, 127V AC and 220V AC.

#### •Joy stick selector switches

##### Ball type without lock

Screw terminal AR22A0N, A5N

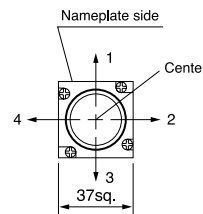
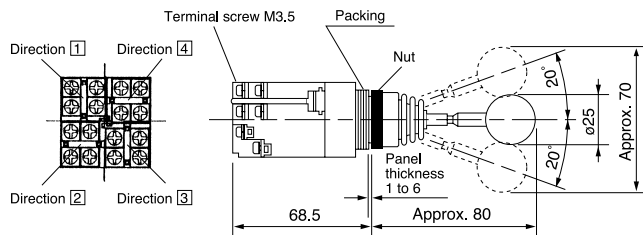

Solder/tab terminal AR22A0H, A5H

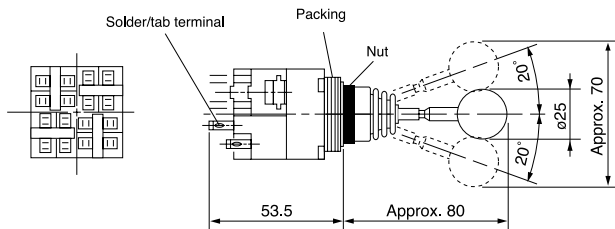

Notes \* The contact arrangement is operable in the designated direction by pulling the lock piece in the central position with the fingers. The lock piece will return automatically and locks when the lock piece is released in the central position. The lock piece locks in the central position only.

##### Ball type with lock

Screw terminal AR22A1N, A6N

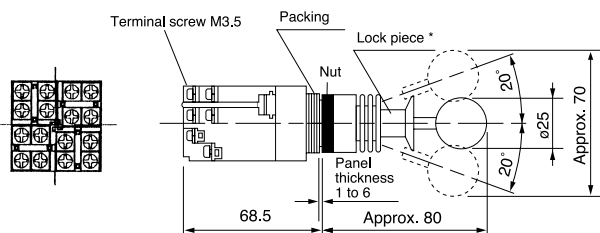

Solder/tab terminal AR22A1H, A6H

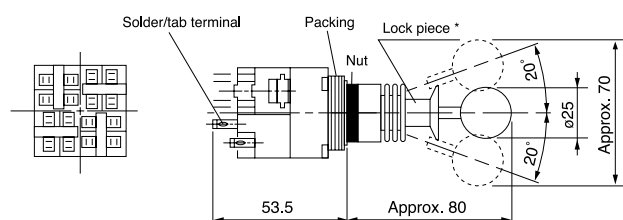

# Pushbuttons/Selectors/Pilot Lights/Buzzers

## AR22 and DR22

### Dimensions

#### ■ Dimensions, mm

#### • Joy stick selector switches

#### Rubber cap type without lock

Screw terminal AR22A2N, A7N

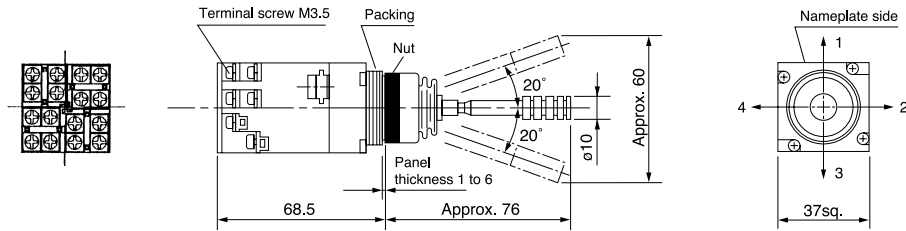

Solder/tab terminal AR22A2H, A7H

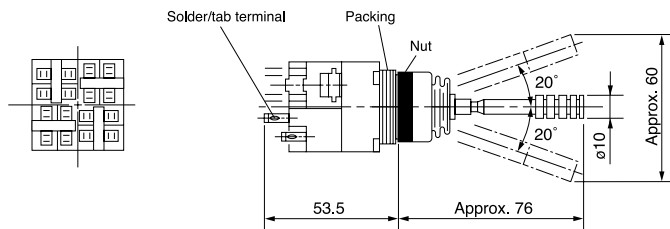

#### • Buzzers

#### Electronic sound

With transformer

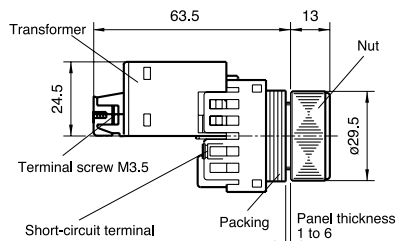

DR22B5

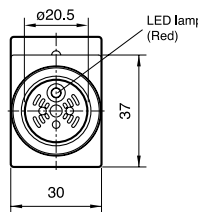

Without transformer

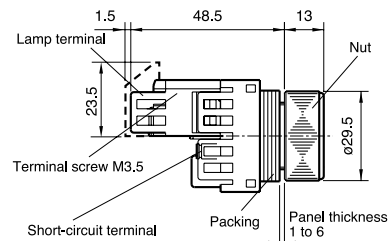

DR22B5

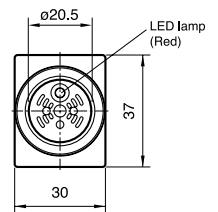

#### Magnetic sound

With transformer

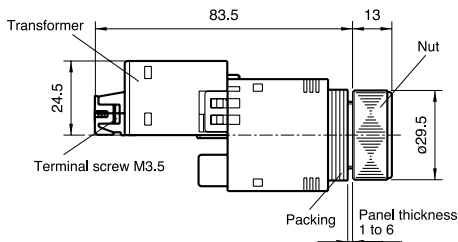

DR22B3

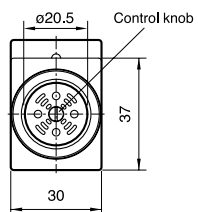

Without transformer

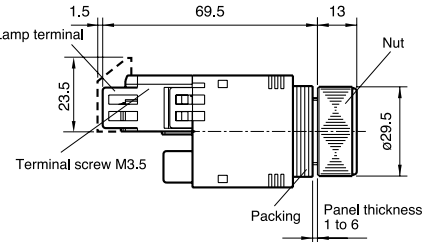

DR22B3

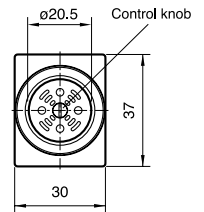

#### Electronic sound (IP54)

With transformer

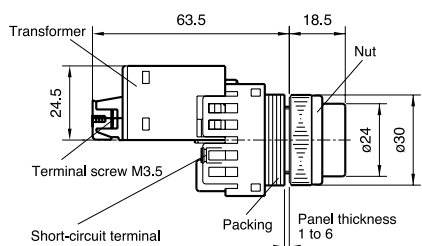

DR22B8

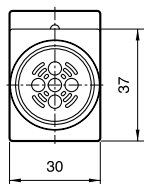

Without transformer

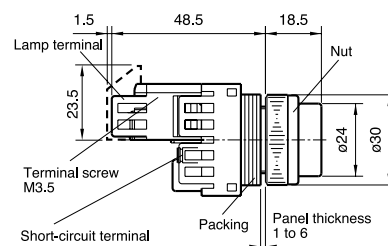

DR22B8

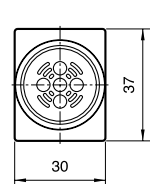

# Pushbuttons/Selectors/Pilot Lights/Buzzers

## AR22 and DR22

### Notes on use

#### Notes on use

##### ■ Fit two sizes of panel cutout holes

\* The unique nut with a step allows switch to be mounted in either 22.3mm- or 25.5mm-dia. holes as shown in Fig. 1 without any extra adapter.

**Fig. 1 Panel cutout**

The switch mounted as a  $\phi 22\text{mm}$  diameter unit.

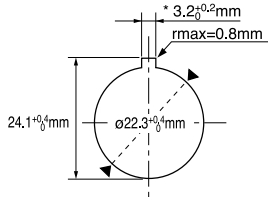

The switch mounted as a  $\phi 25\text{mm}$  diameter unit.

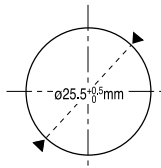

Note: \* If key-washer or legend plate are not used, 3.2mm-wide location holes need not be cutout.

##### ■ Detaching contact block from the operator

While keeping the white release arm pressed with one finger, pull-out the contact block in the direction by the arrow.

**Fig. 2 Detaching contact block from the operator**

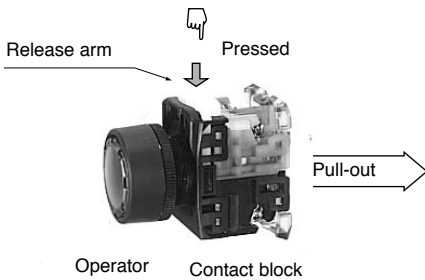

##### ■ Mounting operator to panel

① In a 22.3mm-dia. panel cutout hole  
Insert the operator into the cutout hole from the panel front as shown in the Fig. 3.  
Then, fit section "A" of the AR9A004 wrench from behind the panel and secure the operator with nut. (See page 106 for the wrench)

**Fig. 3 Mounting an operator in a 22.3mm-dia. hole**

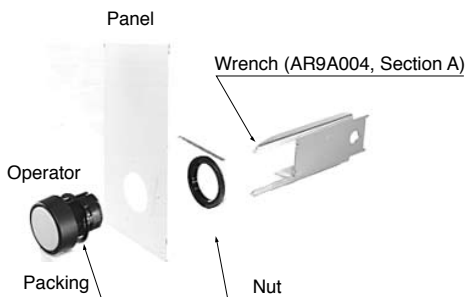

Note: Recommended tightening torque is from 1 to 1.5N·m

② In a 25.5mm-dia. panel cutout hole

As shown in Fig. 4, with the nut step-out side oriented to the panel, use the wrench to tighten the nut and secure the operator.

**Fig. 4 Mounting a operator in a 25.5mm-dia. hole**

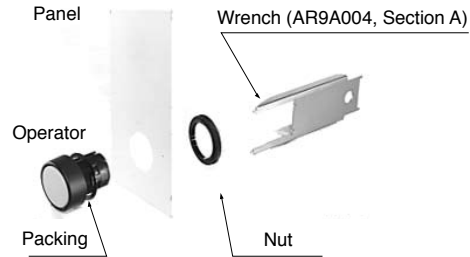

Note: 1. Recommended tightening torque is from 1 to 1.5N·m  
2. Ensure that the step-out portion of the nut is correctly fitted in the cutout hole.

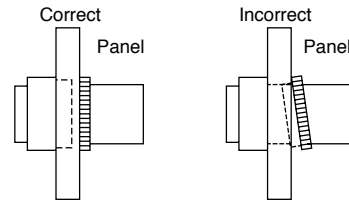

For easier mounting in the 25.5mm-dia. hole, the AR9Y718 adapter is also available separately.

**Fig. 5 Mounting with an adapter and locking nut**

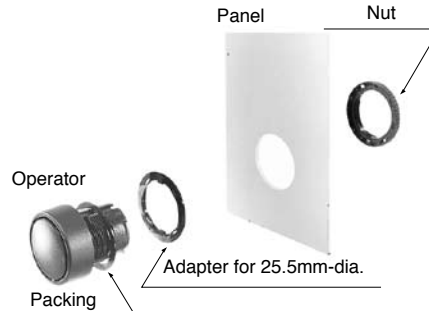

##### ■ Mounting contact block to the operator

As shown in Fig. 6, align the protruding part of the contact block release arm with the operator groove at the  $\nabla$  mark.  
Then, insert the contact block into the operator until it clicks.

**Fig. 6 Mounting the contact block to the operator**

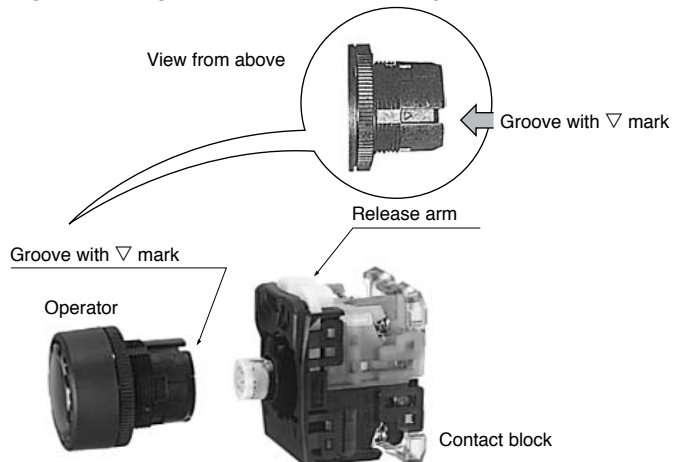

■ **VG type panel mounting**

As shown in the illustration, remove the live section cover, nut, and washer, and insert the main unit into a panel which has been cut from the front side of the panel. Place the type number AR22 facing upward, and secure the main unit with the nut using a wrench AHX701. The appropriate tightening torque is 1 to 1.5N·m.

Fig. 7

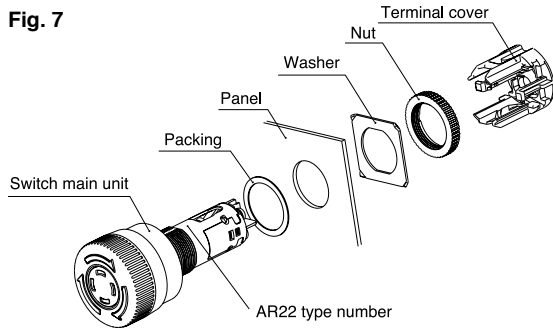

■ **Joy stick selector switch mounting on panel**

- (1) Twist and remove the ball from the operator.
- (2) Loosen the nut and remove the switch if the switch is provided with a lock.
- (3) If no locking nut is provided, loosen the nut and remove the switch after the packing part (A) shown in the illustration is stretched to the lever groove.
- (4) Mount the switch in the order opposite to removal. Set the packing to the notch on the lever as a reference. Do not separate the nut from the packing.
- (5) Use a torque wrench AR9A006 to tighten the nut from the front of the panel.

Note: Recommended tightening a torque is 1 to 1.5N·m.

Fig. 8

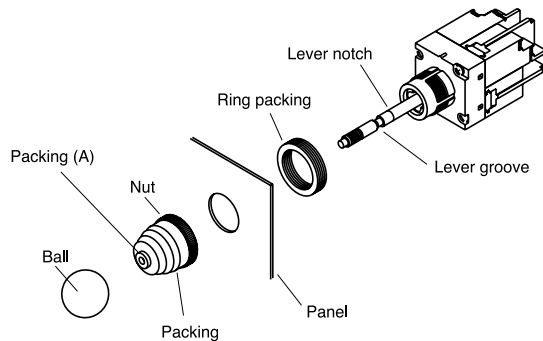

■ **Buzzer mounting on panel**

- (1) Remove the nut, and insert the main unit into the mounting hole from the back of the panel.
- (2) Tighten the buzzer using a wrench AR9A006 from the front side of the panel.

Note:

- Recommended tightening torque is 1 to 1.5N·m.
- Electronic sound (IP54) type has a all-in-one unit with nut and cap.

■ **Applicable panel thickness**

The AR22/DR22 series switches are mountable to panels with thickness as given in Table below.

Mounting condition		Applicable panel thickness (mm)	
Without accessories		1 to 6	
With accessories	Protective cover, water-proof cap, legend plate	1 to 4	
	Key washer	without hole	1 to 4
		with hole	1 to 5
	Adapter for a 25.5mm-dia. hole		1 to 5.5

• When using a joy stick selector switch and buzzer

The applicable panel thickness is 1 to 6mm. Five 1.3mm packings (single-piece type) are included as standard equipment. Insert as many as required depending on the panel thickness, using the following table as a guide. When using a key washer, legend plate, or adapter, their thickness will have to be added to the values in the guide.

Panel thickness (mm) (plus key washer, legend plate)	Number of packings (reference)
1.0 to 1.6	5
1.6 to 2.8	4
2.8 to 3.8	3
3.8 to 4.8	2
4.8 to 6.0	1

# Pushbuttons/Selectors/Pilot Lights/Buzzers

## AR22 and DR22

### Notes on use

#### ■ Minimum mounting space, mm

##### (1) Minimum mounting space

Fig. 10

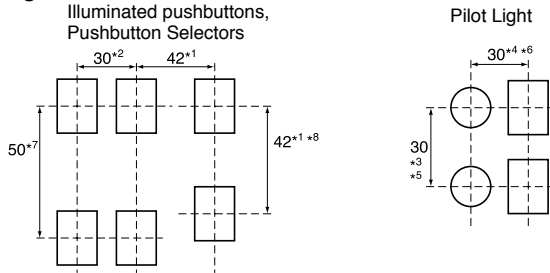

- Notes:
- \*1 AR22M0□, M5□, V5□, V0□, V2□, V7R, VG□: 42mm  
AR22M3R, M8R: 49mm  
AR22Q2R, WR, W0R, WY, WCY: 40mm
  - \*2 When mounting contact blocks at 30mm pitch, use it circuit of 380V or less.
  - \*3 Short body with transformer types: 50mm.
  - \*4 Rectangular types: 36.5mm (except for short body without transformer types).
  - \*5 Short body without transformer types: 60mm.
  - \*6 Rectangular short body without transformer types: 60mm.
  - \*7 This dimension applies when transformer units or contact blocks face each other.
  - \*8 This dimension applies when transformer unit or contact block is mounted on only one side.

When mounting operators on a panel, orient all ▽ marks on the operator upwards.  
(The operator release arms are oriented upwards.) This aligns the terminals of all contact blocks, thus making wiring easy.

##### (2) Detaching contact blocks from operators

As shown in Fig. 9, insert a flat-head screw driver into the groove of the white release arm on the contact block. Then, while inserting the driver in hole A of the operator base, lower the driver grip and take out the contact block.

Fig. 11

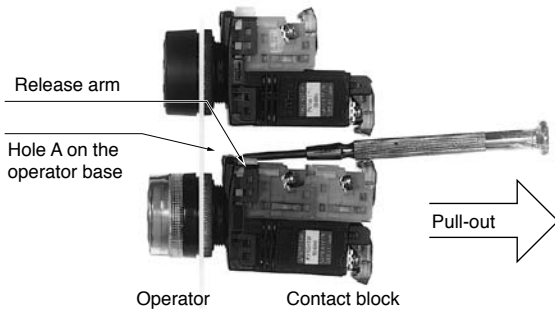

Note: Use a flat head screwdriver as shown at the right.

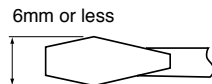

#### ■ Products with blue and green LEDs

The LED devices on products with high-brightness (blue and green) LEDs are very sensitive to static electricity. When replacing LED lamps do not allow static electricity to come into direct contact with the metal frame on the upper side of the LED lamp. The LED device may be damaged if this part is subjected to static electricity. When installing or removing an LED lamp, it is recommended that you use the lamp changer (AHX790).

Fig. 12

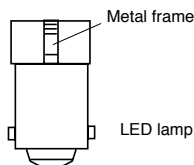

#### ■ Wiring

(1) The terminal screws are M3.5 pan head screws. Solid wires, stranded wires, or crimp terminals can be connected.

Fig. 13

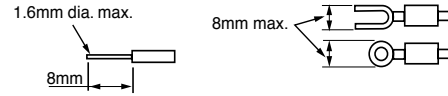

(2) Two crimp terminals can be used by putting one of them on top of the other. If fork-type crimp terminals are used in the horizontal direction, however, use ones as shown in the figure below. (i.e., Toei Tanshi's F2-3.5S or an equivalent).

Fig. 14

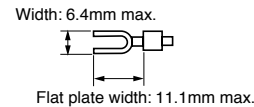

- (3) The terminal washers are a self-lifting type.
- (4) Tighten the terminal screws to a tightening torque of 0.8 to 1N·m.
- (5) Keep the terminals free of external force while wiring or after wiring, or operational failures may result.
- (6) Do not use screws other than the provided terminal screws.

##### Notes:

- If solid wires are connected to the lamp terminals in the horizontal direction (on the side), be sure to insert the solid wires into the square washers.
- Terminal layout., see page 54
- See page 53 for the wiring of the joy stick selector switch and VG type.

#### ■ LED Indicator

##### (1) LED Lamp Malfunctioning

The LED lamp is lit by a very small level of current (approximately 0.01mA). Therefore, it may be erroneously lit by a leaking current from the surge absorption circuit or semiconductor circuit or due to stray capacitance between cables. In that case, provide a countermeasure (e.g., connect a resistor in parallel with the LED lamp).

##### • Countermeasure for Malfunctioning

The LED lamp malfunctions can be prevented by connecting a shunt resistor (R) or CR elements (a capacitor and resistor) in parallel with the LED lamp terminal. The resistance and CR values vary depending on the model and the operating conditions.

Fig. 15

##### Example 1

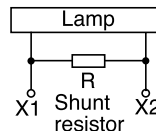

- 24V DC  
R: 10kΩ (0.5W)
- 24V AC  
R: 2kΩ (2W)

##### Example 2

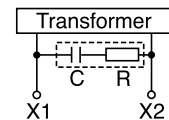

- 100V AC  
C: 0.33μF (250V AC)  
R: 120Ω (0.25W)
- 220V AC  
C: 0.1μF (250V AC)  
R: 120Ω (0.25W)

##### (2) Incoming surge

High luminance LED products use an element sensitive to static electricity. They may not be lit by an abnormal voltage like surge. Please note it.

■ **Joy stick selector switch**

- Screw terminal wiring
- (1) The terminals use M3.5 pan head screws. Use crimp terminals to wire the terminals.

Fig. 16

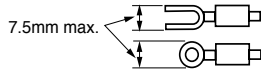

- (2) The terminal washers are a self-lifting type.
- (3) Tighten the terminal screws to a tightening torque of 0.8 to 1.0N·m. Keep the terminals free of external force during and after wiring, or operational failures may result.

- Solder (tab terminal) wiring

- (1) Pay attention to the following items when soldering the terminals.
  - Use a soldering iron with a power consumption of 30W. Use resin-core solder.
  - If a 30W soldering iron is used, finish soldering the terminals within five seconds. If a 20W soldering iron is used, finish soldering the terminals within 10 seconds. Make sure that the soldering iron tip length is at least 20mm long. Do not apply external force to the terminals. Because lead-free solder's melting point is slightly high, soldering work may be difficult. Use a soldering iron whose tip is rather large or whose calorie is rather high.
- (2) When using adjacent terminals, use insulation tubes to prevent the terminals from short-circuiting. Utmost attention must be paid to the solder terminals if especially thick wires are used or if a large quantity of solder is used.
- (3) Connectable wires
  - Solid wire: 2 wires, 0.8mm dia. max.
  - Stranded wire: 1 wire, 0.75mm<sup>2</sup> max.
- (4) Use the 110 (2.8mm) series receptacle for the tab terminals.
- (5) Wire the tab terminals with the contact unit connected to the main unit.

- Operation

Operation shall be made after the joy stick operation lever is surely returned to the center position. Do not apply excessive force to the operation lever. The maximum permissible force is 100N.

- Use of contact blocks

If NO and NC contacts are used in the same contact block, check that there is no difference in potential. Do not connect different type of power source different in type.

■ **Buzzer**

- Noise

If the application circuit is likely to generate excessively strong noise, connect a surge absorber (e.g., FUJI's ENC390D, provided that the switch is a 24V type) in parallel with the buzzer.

- Place of Use

The buzzer does not have a drip-proof construction. Do not use the buzzer in places where oil or water is sprayed or where dust accumulates. If the buzzer is a splash-proof type, it will resist sprays of water.

- Do not use the buzzer in places that are subject to an excessive amount of corrosive gas.
- Note that the buzzer is likely to sound erroneously due to leakage current or the like.

■ **AR22VG type**

- As shown in Fig. 17 (a), engage the tip of the wrench (AHX8003) with the groove in the center to mount or remove the locking unit. The recommended tightening torque is 0.6 to 1N·m.
- As shown in Fig. 17 (b), insert the lamp changer (AHX790) and press the lamp changer to mount or remove the lamp. Turn the lamp changer clockwise when mounting the lamp and counterclockwise when removing it.

Fig. 17

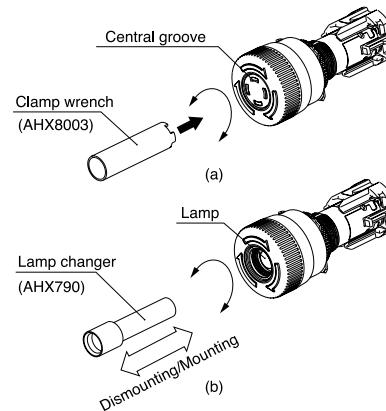

Note: The lamp and neon lamp are special models for the AR22VGF. Use only these special lamps for replacement.

- Wiring

The terminals use M3.5 pan head screws. Use crimp terminals for wiring and cover the crimp terminals with insulation tubes.

Fig. 18

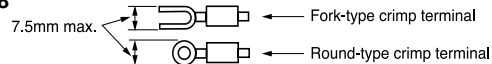

- The terminal washers are a self-lifting type.
- Tighten the terminal screws to a torque of 0.8 to 1N·m. Keep the terminals free of external force during and after wiring, or operational failures may result.
- Wiring precautions
  - (1) Use of round-type crimp terminal
  - Remove the live section cover, and half-tighten to the point parallel with the terminal rib white marks in the direction of the arrows as shown in the illustration below.
  - Mount the live section cover and tighten the terminals securely.

Fig. 19

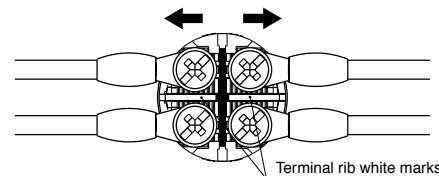

As shown in the illustration below, mount the live section cover so that the mounting legs of the cover engage with the concave parts of the main unit.

Fig. 20

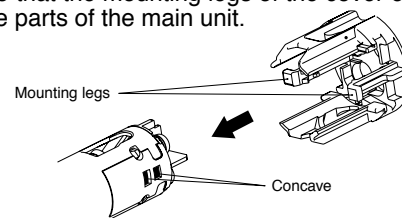

- (2) If fork-type crimp terminals are used, wiring will be possible without removing the live section cover.

# Pushbuttons/Selectors/Pilot Lights/Buzzers

## AR22 and DR22

### Notes on use

#### ■ Operation

- Do not use a hitting or bouncing action to operate the button, or the switch may break. Always operate the switch by hand. Do not pull mushroom head pushbuttons or alternate buttons other than the Q2.
- Do not rotate the selector ring type while the button is pressed, or the mechanism may break.
- The control type incorporates make-before-break contacts.
- The dial of the selector switch rotates with a light force. Do not apply force in excess of 1N·m. Please do not pull out or insert the key forcibly.
- To release the lock of the push-lock type, rotate the button clockwise as shown by the arrow. Do not pull the button, or the latch may break and the lock may fail to work.
- Do not lock the emergency stop pushbutton switch and emergency stop illuminated pushbutton switch in use. Push and lock the switch in case of an emergency only.

#### ■ Terminal layout

Fig. 21

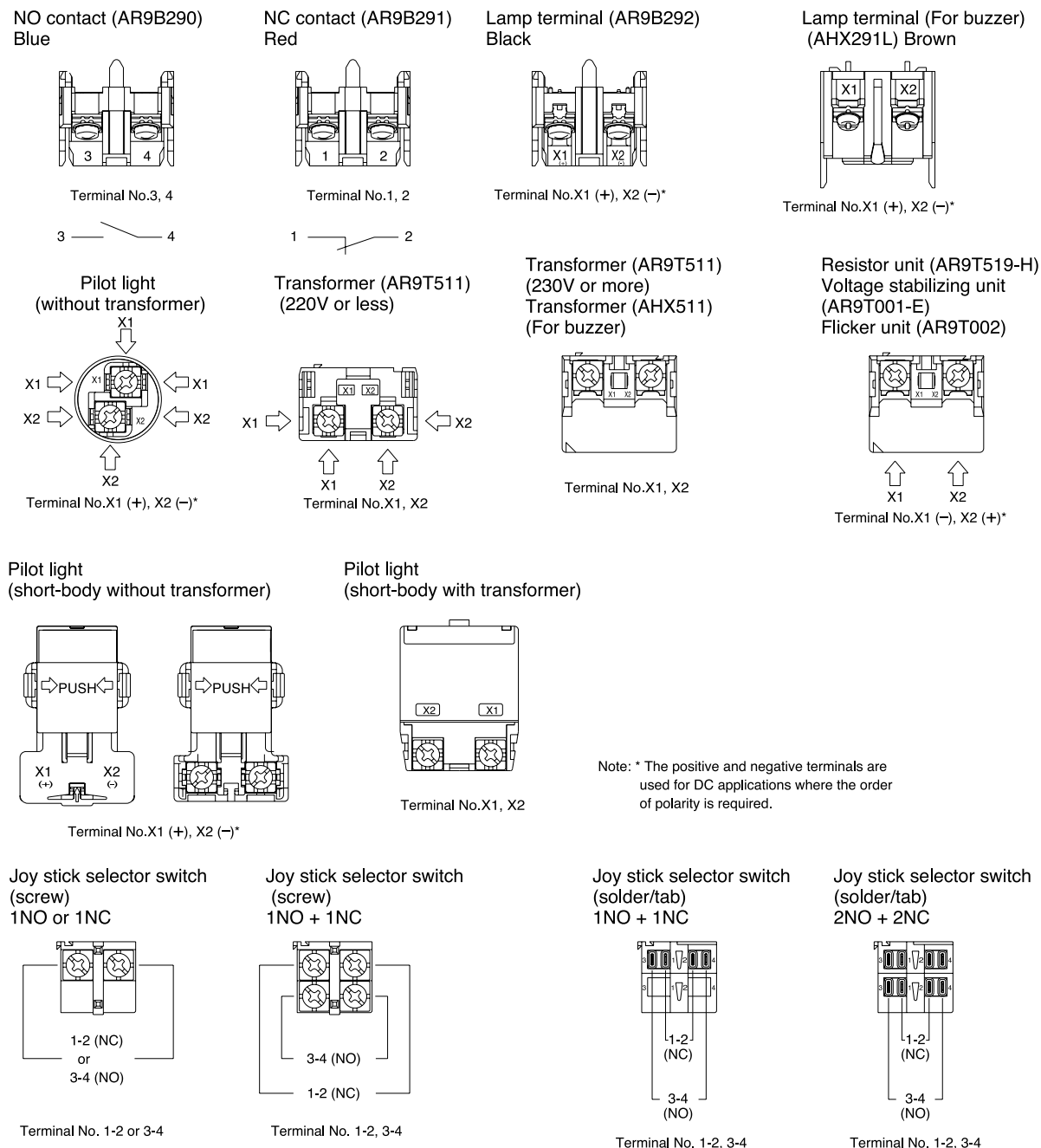



# Pushbuttons/Selectors/Pilot Lights/Buzzers

## AR30 and DR30

### General information

The full range of the contact blocks and transformer units suitable for the AR22 and DR22 series may also be fitted to the AR30 and DR30 series.

#### ■ Features

##### Quick-replacement contact blocks and transformer units

The snap-on construction makes replacement and addition of contact blocks and transformer units very simple and straightforward.

##### Oil-and dust-proof operator module construction

The protection level of the AR30/DR30 operator modules conforms to IEC Standard IP65. The special seals protect the operator modules and switch mechanisms against oil, dust, and grime, thus ensuring high performance in dusty and moist environments.

#### Miniaturization

- Selector switches with 1NO+1NC: 41mm deep
- Pilot lights: 34mm deep
- The transformer now occupies far less space.

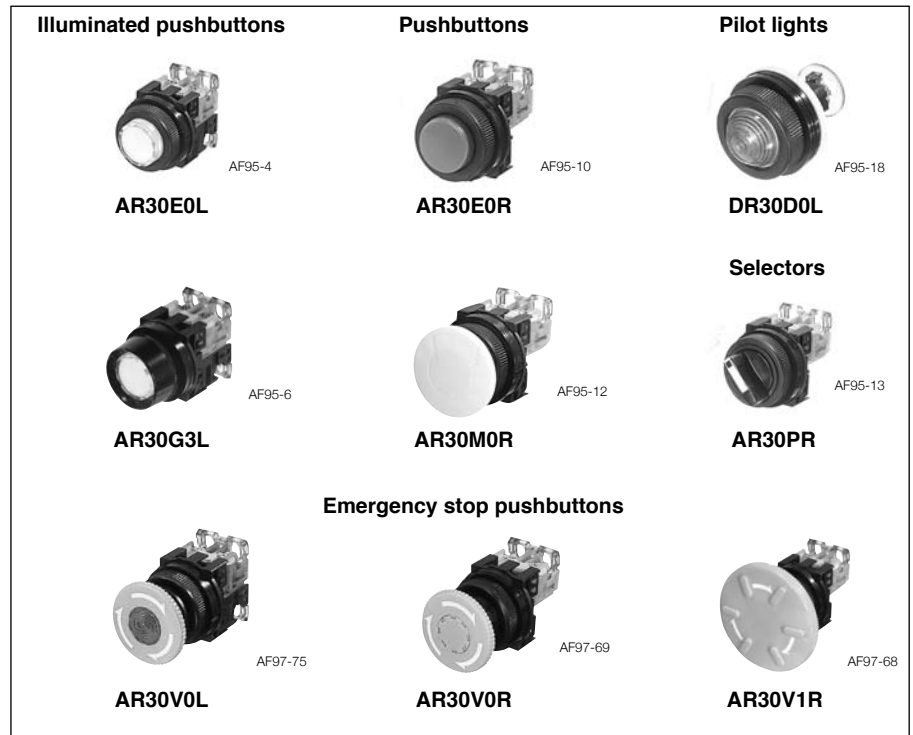
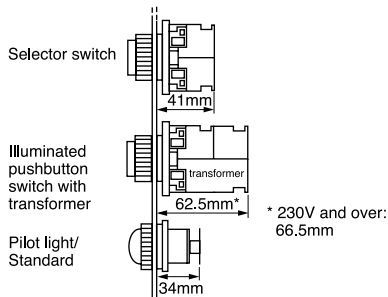

#### Self-cleaning contacts

All the contacts are double break type and feature self-cleaning action. Every time the switch is operated, the contact surfaces are wiped with a sliding movement, thus ensuring high contact reliability even at low voltage and small current levels (5V, 5mA).

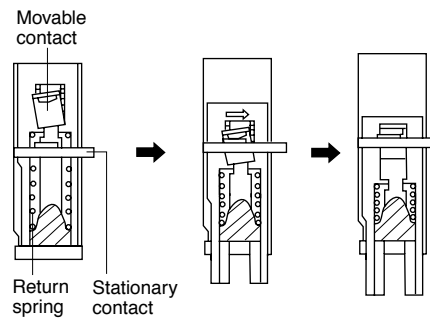

#### Metal nut

Safer model with metal nut is also available



#### Wiring

- Wiring from two directions is possible.
- Wiring in both vertical and lateral directions facilitates wiring in narrow spaces.
- Color coding of contact blocks makes wiring easy.  
1NO: Blue, 1NC: Red  
Lamp terminal and transformer unit: Black

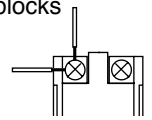

#### Safety

- A terminal cover is provided, assuring safety and security.
- FUJI's original Trigger Action mechanism is used in the emergency stop pushbuttons. They are suitable for emergency stop and safety. This mechanism prevents the contacts from moving until the button is pushed and locked.

#### Protection

- Excellent oil-tight construction (IP65) of the operator.
- Closure of the contact block has been improved.

#### ■ Approvals



# Pushbuttons/Selectors/Pilot Lights/Buzzers

## AR30 and DR30

### Quick reference guide

#### ■ Illuminated pushbutton switches

Operator	Type	Operator	Type	Operator	Type
Extended round head	<b>AR30E0L, E5L</b>  AF95-4	Extended with full guard (24mm dia. with openings)	<b>AR30G2L, G7L</b>  AF99-328	Push-lock, turn-reset (40mm dia. with white arrow)	<b>AR30V5L</b>  AF97-75
Extended with transparent full guard (24mm dia.)	<b>AR30G4L, G9L</b>  KKD05-164	Extended with full guard (24mm dia.)	<b>AR30G3L, G8L</b>  AF95-6	Push-pull	<b>AR30Q7L</b>  AF96-185

#### ■ Pushbutton switches

Operator	Type	Operator	Type	Operator	Type
Flush round head	<b>AR30F0R, F5R</b>  AF95-11	Mushroom head (29mm dia.)	<b>AR30M4R</b>  AF95-8	Mushroom head with full guard (35mm dia. metal nut)	<b>AR30GSR</b>  AF96-239
Extended round head	<b>AR30E0R, E5R</b>  AF95-10	Extended with full guard (24mm dia.)	<b>AR30G1R, G6R</b>  AF95-16	Giant head	<b>AR30B0R</b>  AF95-579
Flush round head Symbol mark type	<b>AR30FAR, FBR</b>  AF98-195	Extended with half guard	<b>AR30G0R, G5R</b>  AF95-9	Giant head with guard	<b>AR30B1R</b>  AF95-582
Extended round head Symbol mark type	<b>AR30EAR, EBR</b>  AF98-194	Pin lock	<b>AR30GPR</b>  AF96-240	Giant head with full guard	<b>AR30B2R</b>  AF95-580
Mushroom head (40mm dia.)	<b>AR30M0R, M5R</b>  AF95-12	Mushroom head with full guard (40mm dia.)	<b>AR30M3R, M8R</b>  AF95-17	Giant head with full guard	<b>AR30B3R</b>  AF95-581









Note: AR30M8R: Not approved standard

# Pushbuttons/Selectors/Pilot Lights/Buzzers









## AR30 and DR30

### Quick reference guide

#### ■ Pushbutton switches





Operator	Type	Operator	Type	Operator	Type
Pushbutton with selector ring (2-position)	<b>AR30S1R, S2R, S3R, S6R</b>  AF97-506	Push-lock, turn-reset (40mm dia. with white arrow)	<b>AR30V5R</b>  AF97-69	Pushbutton with emergency operating cap	<b>AR30FVR</b>  AF96-187
					
Push, turn-lock	<b>AR30N0R</b>  AF95-583				
					

#### ■ Emergency stop pushbutton switches (conform to EN418)

Operator	Type	Operator	Type	Operator	Type
Push-lock, turn-reset (Soft-touch 40mm dia. with white arrow)	<b>AR30V0R</b>  AF97-69	Push-lock, turn-reset (65mm dia. with white arrow)	<b>AR30V1R</b>  AF97-68	Push-lock, pull-reset (35mm dia.)	<b>AR30Q2R</b>  AF95-3
					
Push-lock, turn-reset (40mm dia.)	<b>AR30V2R</b>  AF95-176				
See page 04/79, 04/101					

Notes: Provided with the  (Direct opening action)

#### ■ Emergency stop illuminated pushbutton switches (conform to EN418)

Operator	Type	Operator	Type
Push-lock, turn-reset (Soft-touch 40mm dia. with white arrow)	<b>AR30V0L</b>  AF97-75	Push-lock, turn-reset (40mm dia.)	<b>AR30V2L</b>  AF95-2
			





Note: Provided with the  (Direct opening action)

# Pushbuttons/Selectors/Pilot Lights/Buzzers

## AR30 and DR30

### Quick reference guide

#### ■ Selector switches

Operator	Type	Operator	Type	Operator	Type
Knob	<b>AR30PR, PCR</b>  AF95-13	Key	<b>AR30JR, JCR</b>  AF95-15	Key (Long durability)	<b>AR30JAR</b>  AF95-15
Lever	<b>AR30WR, WCR</b>  AF95-14				

#### ■ Illuminated selector switches

Operator	Type
Knob	<b>AR30PL</b>  AF95-5

#### ■ Pilot lights

Lens	Type	Lens	Type	Lens	Type
Dome	<b>DR30D0L</b>  AF95-18	Dome with dimmer control	<b>DR30D1L</b>  AF02-63	Flush square (40mm sq. transparent lens)	<b>DR30M4M *</b>  AF97-63
Extended round	<b>DR30E3L</b>  AF95-20	Flush square (34mm sq. transparent lens)	<b>DR30F4M *</b>  AF97-65		
Faceted	<b>DR30K0L</b>  AF95-19	Flush rectangular (Transparent lens)	<b>DR30F4N *</b>  AF97-64		







Note: With resistor unit and resistor types: Not approved standard  
\* LED 12V AC type: Not approved standard

# Pushbuttons/Selectors/Pilot Lights/Buzzers



## AR30 and DR30

### Quick reference guide

#### ■ Joy stick selector switches



Handle	Type	Handle	Type	Handle	Type
Ball type	<b>AR30A0, A5</b>  AF97-48	Ball type with lock	<b>AR30A1, A6</b>  AF97-44	Rubber cap type	<b>AR30A2, A7</b>  AF97-57
					

#### ■ Buzzers

Sound	Type	Sound	Type	Sound	Type
Electronic sound	<b>DR30B5*</b>  AF96-381	Magnetic sound	<b>DR30B0</b>  AF96-378	Electronic sound (IP54)	<b>DR30B8 *</b>  AF96-245
					
Electronic sound (economy)	<b>DR30B6</b>  KK02-17				
					

Note: \* 6V AC, 110V DC types: Not approved standard

#### ■ Numerical indicators

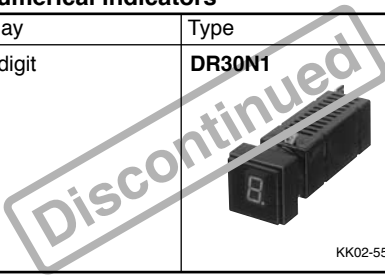
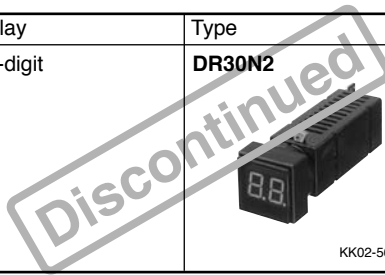
Display	Type	Display	Type
One-digit	<b>DR30N1</b>  KK02-55B	Two-digit	<b>DR30N2</b>  KK02-56B
			

# Pushbuttons/Selectors/Pilot Lights/Buzzers

## AR30 and DR30

### Part number system

#### Illuminated pushbuttons

**AR30 E0L – 10 E3 R □**

① ② ③ ④ ⑤ ⑥

#### ① Product category

AR30: 30mm-dia. illuminated pushbutton  
 30mm-dia. emergency stop illuminated pushbutton

#### ② Operator

- Illuminated pushbutton
- E0L: Extended round head
- E5L: Extended round head (Alternate)
- G4L: Extended with transparent full guard (24mm dia.)
- G9L: Extended with transparent full guard (24mm dia. alternate)
- G2L: Extended with full guard (24mm dia. with openings)
- G7L: Extended with full guard (24mm dia. with openings, alternate)
- G3L: Extended with full guard (24mm dia.)
- G8L: Extended with full guard (24mm dia. alternate)
- V5L: Push-lock, turn-reset (40mm dia. with white arrow) \*1
- Q7L: Push-pull
- Emergency stop illuminated pushbutton
- V0L: Push-lock, turn-reset (Soft-touch 40mm dia. with white arrow)
- V2L: Push-lock, turn-reset (40mm dia.)

#### ③ Contact arrangement

10: 1NO	30: 3NO
01: 1NC	03: 3NC
11: 1NO+1NC	33: 3NO+3NC
20: 2NO	40: 4NO
02: 2NC	04: 4NC
22: 2NO+2NC	50: 5NO
	05: 5NC

#### ④ Lamp voltage

- Incandescent lamp
- 54: 5.5V AC/DC, without transformer
- C4: 15V AC/DC, without transformer
- D4: 20V AC/DC, without transformer
- E4: 24V AC/DC, without transformer
- H4: 100-110V AC, with transformer
- L4: 115-127V AC, with transformer
- M4: 200-220V AC, with transformer
- Q4: 230-254V AC, with transformer
- S4: 350-380V AC, with transformer
- T4: 400-440V AC, with transformer
- V4: 480V AC, with transformer
- W4: 500-550V AC, with transformer
- LED lamp
- A3: 6V AC, without transformer
- 63: 6V DC, without transformer
- B3: 12V AC/DC, without transformer
- C3: 15V AC/DC, without transformer
- E3: 24V AC/DC, without transformer
- H3: 100-110V AC, with transformer
- L3: 115-127V AC, with transformer
- M3: 200-220V AC, with transformer
- Q3: 230-254V AC, with transformer
- S3: 350-380V AC, with transformer
- T3: 400-440V AC, with transformer
- V3: 480V AC, with transformer
- W3: 500-550V AC, with transformer

#### ⑤ Color of lens

G: Green	Y: Yellow
R: Red *2	A: Orange
W: White	S: Blue

#### ⑥ Special product

- Z9: Resisting water-soluble cutting oils and heat
- Z8: With a contact protection cover
- Z4: Resisting sulfuration gas
- ZB: Meeting IP2X finger-protection standards
- ZM: Metal nut

Notes: \*1 Products with no trigger action mechanism. These products cannot be used as emergency stop switches that comply with EN standards.

\*2 Button color of emergency stop illuminated switches are Red only.

- The manufacturing range varies depending on the model. For details, refer to the contents of this catalog.

# Pushbuttons/Selectors/Pilot Lights/Buzzers

## AR30 and DR30

### Part number system

#### Pushbuttons

#### AR30 E0R – 10 R

① ② ③ ④ ⑤ ⑥

##### ① Product category

AR30: 30mm-dia. pushbutton  
30mm-dia. emergency stop pushbutton

##### ② Operator

- Pushbutton switch
- F0R: Flush round head
- F5R: Flush round head (Alternate)
- E0R: Extended round head
- E5R: Extended round head (Alternate)
- FAR: Flush round head (Symbol mark type)
- FBR: Flush round head (Symbol mark type, alternate)
- EAR: Extended round head (Symbol mark type)
- EBR: Extended round head (Symbol mark type, alternate)
- M0R: Mushroom head (40mm dia.)
- M5R: Mushroom head (40mm dia. Alternate)
- M4R: Mushroom head (29mm dia.)
- G1R: Extended with full guard (24mm dia.)
- G6R: Extended with full guard (24mm dia. Alternate)
- GPR: Pin lock
- G0R: Extended with half guard
- G5R: Extended with half guard (Alternate)
- M3R: Mushroom head with full guard (40mm dia.)
- M8R: Mushroom head with full guard (40mm dia. Alternate)
- GSR: Mushroom head with full guard (35mm dia. metal nut)
- B0R: Giant head
- B1R: Giant head with guard
- B2R: Giant head with full guard
- B3R: Giant head with full guard
- S1R: Pushbutton with selector ring (2-position)
- S2R: Pushbutton with selector ring (2-position)
- S3R: Pushbutton with selector ring (2-position)
- S6R: Pushbutton with selector ring (2-position)
- N0R: Push, turn-lock
- V5R: Push-lock, turn-reset (40mm dia. with white arrow) \*1
- FVR: Pushbutton with emergency operating cap
  - Emergency stop pushbutton switch
- V0R: Push-lock, turn-reset (Soft-touch 40mm dia. with white arrow)
- V2R: Push-lock, turn-reset (40mm dia.)
- V1R: Push-lock, turn-reset (Soft-touch 65mm dia. with white arrow)
- Q2R: Push-lock, pull-reset (35mm dia.)

##### ③ Contact arrangement

10: 1NO	30: 3NO
01: 1NC	03: 3NC
11: 1NO+1NC	33: 3NO+3NC
20: 2NO	40: 4NO
02: 2NC	04: 4NC
22: 2NO+2NC	44: 4NO+4NC
	50: 5NO
	05: 5NC

##### ④ Color of button

G: Green	Y: Yellow
R: Red <sup>2</sup>	A: Orange
B: Black	S: Blue
W: White	C: Clear
T: Green, Red, Black (For AR30F0R)	(For AR30FAR, FBR, EAR, EBR)

##### ⑤ Symbol mark (For AR30FAR, FBR, EAR, EBR)

Symbol mark	○	I	⊕	○	I	⊕
Color of button	White	Black	White	Black	White	Black
Color of mark	Red	Green	Green	Black		
Code	01	02	03	04	11	12
					02B	04B
						12B

##### ⑥ Special product

- Z9: Resisting water-soluble cutting oils and heat
- Z8: With a contact protection cover
- Z4: Resisting sulfuration gas
- ZB: Meeting IP2X finger-protection standards
- ZM: Metal nut

Notes: \*1 Products with no trigger action mechanism. These products cannot be used as emergency stop switches that comply with EN standards.  
\*2 Button color of emergency stop switches are Red only.  
• The manufacturing range varies depending on the model. For details, refer to the contents of this catalog.

# Pushbuttons/Selectors/Pilot Lights/Buzzers

## AR30 and DR30

### Part number system

#### Selector and illuminated selector switches

**AR30 PL – 2**  **10 E3 G**

① ② ③ ④ ⑤ ⑥ ⑦ ⑧ ⑨

#### ① Product category

AR30: 30mm dia. selector switch and illuminated selector switch

#### ② Operator

•Selector switch

PR: Knob

PCR: Knob operated control type

WR: Lever

WCR: Lever operated control type

JR: Key

JCR: Key operated control type

JAR: Key (Long durability)

•Illuminated selector switch

PL: Knob

#### ③ Operation

2: 2-position, maintained

0: 2-position, spring return

3: 3-position, maintained

6: 3-position, spring/manual return (Left to center)

7: 3-position, spring/manual return (Right to center)

1: 3-position, spring return

4: 4-position, maintained (For AR30PCR, WCR)

5: 5-position, maintained (For AR30PCR, WCR)

#### ④ Key removable position

A: Left

B: Left and right

C: Left, right and center

D: Right

E: Center

F: Right and center

G: Left and center

#### ⑤ Contact arrangement

10: 1NO 30: 3NO

01: 1NC 03: 3NC

11: 1NO+1NC 33: 3NO+3NC

20: 2NO 40: 4NO

02: 2NC 04: 4NC

22: 2NO+2NC 44: 4NO+4NC

50: 5NO

05: 5NC

Note: Control type: See page 04/85 to 04/87

#### ⑥ Lamp voltage

•Incandescent lamp

54: 5.5V AC/DC, without transformer

C4: 15V AC/DC, without transformer

D4: 20V AC/DC, without transformer

E4: 24V AC/DC, without transformer

H4: 100-110V AC, with transformer

L4: 115-127V AC, with transformer

M4: 200-220V AC, with transformer

Q4: 230-254V AC, with transformer

S4: 350-380V AC, with transformer

T4: 400-440V AC, with transformer

V4: 480V AC, with transformer

W4: 500-550V AC, with transformer

•LED lamp

A3: 6V AC, without transformer

63: 6V DC, without transformer

B3: 12V AC/DC, without transformer

C3: 15V AC/DC, without transformer

E3: 24V AC/DC, without transformer

H3: 100-110V AC, with transformer

L3: 115-127V AC, with transformer

M3: 200-220V AC, with transformer

Q3: 230-254V AC, with transformer

S3: 350-380V AC, with transformer

T3: 400-440V AC, with transformer

V3: 480V AC, with transformer

W3: 500-550V AC, with transformer

#### ⑦ Color of knob

B: Black (Not available for illuminated selector switch)

G: Green

R: Red

W: White (Not available for selector switch)

Y: Yellow (Not available for selector switch)

A: Orange (Not available for selector switch)

S: Blue (Not available for selector switch)

#### ⑧ Key type No.

A, B, C, D, E or F

("A" is standard)

#### ⑨ Special product

Z9: Resisting water-soluble cutting oils and heat

Z8: With a contact protection cover

Z4: Resisting sulfuration gas

ZB: Meeting IP2X finger-protection standards

ZM: Metal nut

Note: • The manufacturing range varies depending on the model. For details, refer to the contents of this catalog.



# Pushbuttons/Selectors/Pilot Lights/Buzzers

## AR30 and DR30

### Part number system

#### Pilot lights

**DR30 D0L – E3 W**

①      ②      ③      ④      ⑤

#### ① Product category

DR30: 30mm dia. pilot light

#### ② Lens

D0L: Dome

E3L: Extended round

K0L: Faceted

D1L: Dome with dimmer control

F4M: Flush square (34mm sq. transparent lens)

F4N: Flush rectangular (Transparent lens)

M4M: Flush square (40mm sq. transparent lens)

#### ③ Lamp voltage

•Incandescent lamp

54: 5.5V AC/DC, without transformer

C4: 15V AC/DC, without transformer

D4: 20V AC/DC, without transformer

E4: 24V AC/DC, without transformer

H4: 100-110V AC, with transformer

L4: 115-127V AC, with transformer

M4: 200-220V AC, with transformer

Q4: 230-254V AC, with transformer

S4: 350-380V AC, with transformer

T4: 400-440V AC, with transformer

V4: 480V AC, with transformer

W4: 500-550V AC, with transformer

FQ: 50V DC, with resistor\*

HQ: 110V DC, with resistor\*

MQ: 220V DC, with resistor\*

•LED lamp

A3: 6V AC, without transformer

63: 6V DC, without transformer

B3: 12V AC/DC, without transformer

C3: 15V AC/DC, without transformer

E3: 24V AC/DC, without transformer

H3: 100-110V AC, with transformer

L3: 115-127V AC, with transformer

M3: 200-220V AC, with transformer

Q3: 230-254V AC, with transformer

S3: 350-380V AC, with transformer

T3: 400-440V AC, with transformer

V3: 480V AC, with transformer

W3: 500-550V AC, with transformer

H7: 110V DC, with resistor unit

FR: 50V DC, with resistor\*

HR: 110V DC, with resistor\*

MR: 220V DC, with resistor\*

•LED unit

(For DR30F4M, F4N, M4M type)

65: 6V DC, without transformer

25: 12V AC, without transformer

B5: 12V AC/DC, without transformer

E5: 24V AC/DC, without transformer

H5: 100-110V AC, with transformer

L5: 115-127V AC, with transformer

M5: 200-220V AC, with transformer

Q5: 230-254V AC, with transformer

S5: 350-380V AC, with transformer

T5: 400-440V AC, with transformer

V5: 480V AC, with transformer

W5: 500-550V AC, with transformer

HE: 110V DC, with resistor unit

Note: \* DR30D0L, K0L type only

#### ④ Color of lens or color plate

G: Green

Y: Yellow

R: Red

A: Orange

W: White

S: Blue

#### ⑤ Special product

Z9: Resisting water-soluble cutting oils and heat

Z4: Resisting sulfuration gas

ZB: Meeting IP2X finger-protection standards

ZM: Metal nut

Note: \* The manufacturing range varies depending on the model. For details, refer to the contents of this catalog.

# Pushbuttons/Selectors/Pilot Lights/Buzzers

## AR30 and DR30

### Part number system

#### Joy stick selector switches

#### AR30A 0 N – A0A0 B

① ②③ ④ ⑤

##### ① Product category

AR30A: 30mm-dia. Joy stick selector switch

##### ② Handle

- 0: Ball type (without lock, manual return)
- 1: Ball type with lock (manual return)
- 2: Rubber cap type (without lock, manual return)
- 5: Ball type (without lock, spring return)
- 6: Ball type with lock (spring return)
- 7: Rubber cap type (without lock, spring return)

##### ③ Terminal

- N: Screw
- H: Solder/tab

##### ④ Contact arrangement

Contact arrangement	Blank	1NO	1NC	1NO+1NC	2NO	2NC	2NO+2NC	
Code	Screw	0	A	B	1	D	E	–
	Solder/tab	0	–	–	1	–	–	2

Operating direction code of contacts

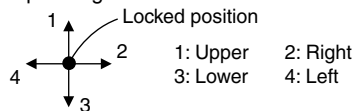

Ex. AR30A0N-A 0 A 0 B  
                  1 2 3 4

##### ⑤ Handle color

- B: Black

#### ■ Ordering information

Specify the following:

##### 1. Type number

For the CCC approved product, add the suffix **(CCC)** to the part number

Example: Pushbutton switch AR30F0R-11B**(CCC)**

#### Buzzers

#### DR30B 5 – E B

① ② ③ ④

##### ① Product category

DR30B: 30mm-dia. buzzer

##### ② Sound

- 5: Electronic sound
- 6: Electronic sound (economy)
- 0: Magnetic sound
- 8: Electronic sound (IP54)

##### ③ Operating voltage

- A: 6V AC (Type “5”, “8”)
- 6: 6V DC (Type “5”, “8”)
- E: 12-24V AC/DC (Type “6” : 24V DC)
- F: 35-48V AC/DC (Type “5”, “8”)
- G: 24V AC (Type “6”)
- H: 100-110V AC
- M: 200-220V AC
- 1: 100-110V DC (Type “5”, “8”)

##### ④ Color of head

- B: Black

# Pushbuttons/Selectors/Pilot Lights/Buzzers AR30 and DR30 Ratings and specifications

## ■ Standards approved

UL508	File No. E44592
CSA C22.2 No.14	File No. LR20479
TÜV: EN60947-5-1	Pushbutton, Illuminated pushbutton: R9551062 Selector, Illuminated selector: R9551060 Pilot lights: R9551061 Joy stick selector switch: R2050803 (Lever switch) Buzzer: J9950091
TÜV: EN60947-5-1	Emergency stop pushbutton
EN60947-5-5	Emergency stop illuminated pushbutton : R50028146

## ■ Specifications (Indoor use)

Description	Pushbutton switch Illuminated pushbutton switch Emergency stop pushbutton switch Emergency stop illuminated pushbutton switch Selector switch Illuminated selector switch	Joy stick selector (Lever switch)	Pilot light
Rated insulation voltage	600V AC/DC *1	250V AC/DC	250V AC/DC *2
Mechanical durability	See page 66	250,000 operations	–
Electrical durability	500,000 operations at 220V AC 6A 1 million operations at 220V AC 3A	100,000 operations at 220V AC 1A (Res. load)	–
Operating frequency	1200 operations/hour (On-load factor: 40%)		–
Dielectric strength	2500V AC, 1 minute *3	2000V AC, 1 minute *4	
Insulation resistance	100MΩ or more (500V DC megger)		100MΩ or more (500V DC megger)
Rated impulse dielectric strength	6kV	–	6kV
Conditional short-circuit current	1000A	1000A	–
Short-circuit protective device	Fuse 15A	Fuse 1A	–
Pollution degree	3		
Vibration	Resonance: 10 to 55Hz, double amplitude 0.1mm *5 Constant: 16.7Hz, double amplitude 3mm		
Shock	Malfunction durability: 100m/s <sup>2</sup> *6 Mechanical durability: 500m/s <sup>2</sup>		Mechanical durability: 500m/s <sup>2</sup>
Ambient temperature (No condensation or no icing)	-20 to +70°C	-5 to +70°C	-20 to +50°C
Storage temperature	-40 to +80°C		
Humidity	45 to 85% RH (within -5 to +40°C)		
Degree of protection	IP65 *7		

Notes: \*1 Illuminated type without transformer: 250V AC/DC

\*2 Pilot light with transformer: 600V AC

\*3 Illuminated type without transformer: 2000V AC, 1 minute

\*4 Pilot light with transformer: 2500V AC, 1 minute

\*5 Emergency stop type: 10 to 500Hz, double amplitude 0.7mm (acceleration 50m/s<sup>2</sup>), according to the test condition of EN60947-5-5 (1998)

\*6 Emergency stop type: 150m/s<sup>2</sup>

\*7 AR30Q7L and DR30D1L type: IP40

# Pushbuttons/Selectors/Pilot Lights/Buzzers

## AR30 and DR30

### Ratings and specifications

#### ● Mechanical durability

Description		Operations
Pushbutton switch	Momentary action	5 million
Illuminated pushbutton switch	Alternate action	1 million
Emergency stop pushbutton switch	With selector ring	100,000
Emergency stop illuminated pushbutton	Push-lock, turn-reset	100,000
	Push-lock, pull-reset	30,000
Selector switch	Maintained 1, 2, 3, 4-contact	1 million
	Maintained 5, 6, 7, 8-contact	500,000
	Control type, spring return, spring/manual return	200,000
Illuminated selector switch	Maintained	
	Without transformer 1, 2, 3-contact	1 million
	4-contact	500,000
	With transformer 1, 2-contact	1 million
	3-contact	500,000
	Spring return, spring/manual return	200,000

Note: Key insertion/removal durability for selector switch key types

- Key type 10,000
- Key (Long durability) type 20,000

#### ● Buzzers

Item	DR30B5	DR30B6	DR30B0	DR30B8
Rated insulation voltage	Without transformer: 60V AC/DC With transformer: 250V AC *1			
Sound level	90dB (0.1m) 70dB (1m)			80dB (0.1m) 60dB (1.0m)
Durability	1000h		80h	1000h
Frequency	2.4 to 3.3kHz	1.9 to 2.5kHz		2.4 to 3.3kHz
Intermittent cycle	Approx. 170-cycle/min	–	–	Approx. 170-cycle/min
Current consumption	See the table below			
Dielectric strength	Without transformer: 1000V AC 1 minute With transformer: 2000V AC 1 minute *2			
Insulation resistance	100MΩ or more (500V DC megger)			
Pollution degree	3			
Vibration	Resonance: 10 to 55Hz, double amplitude 0.1mm Constant: 16.7Hz, double amplitude 3.0mm			
Shock	Mechanical durability: 500m/s <sup>2</sup>			
Ambient temperature	–20 to +60°C (No condensation or no icing) (with resistor unit: –20 to +40°C)			
Storage temperature	–30 to +70°C			
Humidity	45 to 85%RH (within –5 to 40°C)			
Degree of protection	IP00			IP54

Note: \*1 DR30B0 (without transformer): 250V AC

\*2 DR30B0 (without transformer): 2000V AC 1 minute

#### •Current consumption

Operational voltage	Current consumption		
	DR30B5, DR30B8	DR30B6	DR30B0
6V AC	70mA AC	–	–
6V DC	35mA DC	25mA AC	–
24V AC	–	45mA AC	–
24V DC	–	30mA DC	–
24V AC/DC	40mA AC, 25mA DC	30mA AC, 20mA DC	–
48V AC/DC	65mA AC, 20mA DC	–	–
110V AC	30mA AC	30mA AC	30mA AC
110V DC	30mA DC	–	–
220V AC	15mA AC	15mA AC	20mA AC

# Pushbuttons/Selectors/Pilot Lights/Buzzers AR30 and DR30 Ratings and specifications

■ **Contact ratings**  
 • **UL/CSA standards**  
**AC** (COS  $\phi=0.35$ )

Contact rated code	120V		240V		480V		600V	
	Making current	Breaking current	Making current	Breaking current	Making current	Breaking current	Making current	Breaking current
A600	60A	6.0A	30A	3.0A	15A	1.5A	12A	1.2A

**DC**  $T_{0.95}=6P$  (Max. 300ms)

Description	Contact rated code	Making current · Breaking current		
		125V	250V	301V–600V
Illuminated pushbutton switch Pushbutton (Ring type selector switch: AR30S2R only) Emergency stop pushbutton switch Emergency stop illuminated pushbutton switch (Except the overlap contact types)	P600	1.1A	0.55A	0.2A
Overlap contact types of products shown above Pushbutton (Ring type selector switch: AR30S1R, S6R only) Selector switch (2-position only, except the overlap contact types) Illuminated selector switch (2-position only, except the overlap contact types)	Q600	0.55A	0.27A	0.1A
Pushbutton (Ring type selector switch: AR30S3R only) Selector switch (2-pos./overlap contact type, 3-, 4-, 5-pos. type) Illuminated selector switch (2-pos./overlap contact type, 3-pos. type)	R300	0.22A	0.11A	–

Note: Joy stick selector switches (Lever switches): 250V AC, 5A (Res. load) 125V DC, 0.2A 24V DC, 1A (Res. load)

• **EN standard/TÜV approved**

Description	Rated operational current			
	Rated thermal current	Rated operational voltage	AC15 (Ind. load)	DC13 (Ind. load)
			Rated operational current	Rated operational current
Illuminated pushbutton switch Pushbutton (Except the selector ring type) Emergency stop pushbutton switch Emergency stop illuminated pushbutton switch Selector switch (2-position) Illuminated selector switch (2-position)	10A	24V	6.0A	4.0A
		120V	6.0A	–
		125V	–	1.3A
		240V	6.0A	–
		250V	–	0.45A
		480V	2.5A	–
		600V	2.0A	–
Selector switch (3, 4, 5-position) Illuminated selector switch (3-position) Pushbutton with selector ring	10A	24V	6.0A	2.0A
		120V	6.0A	–
		125V	–	0.65A
		240V	6.0A	–
		250V	–	0.23A
		480V	2.5A	–
		600V	2.0A	–
Joy stick selector switch (Lever switch)	5A	24V	–	0.7A
		120V	0.3A	–
		125V	–	0.15A
		240V	0.3A	–

Lamp rated voltage UL/CSA standards, TÜV approved

	LED lamp	Incandescent lamp
Full-voltage (without transformer)	Max. 24V AC/DC	Max. 30V AC/DC
With transformer	Max. 550V AC (Short-body type: Max. 220V AC)	

# Pushbuttons/Selectors/Pilot Lights/Buzzers

## AR30 and DR30

### Ratings and specifications

#### ■ Operating characteristic (1NO+1NC)

Description	Pushbutton Illuminated pushbutton	Emergency stop pushbutton		Selector *2		
		Emergency stop illuminated pushbutton		Illuminated selector		
		Push-lock type	Push-pull type	Maintained	Spring/manual return	Spring return
Ave. required operating force	9N (Push-lock type: 20N)	30N *1	45N	0.15N•m	0.13N•m	0.1N•m
Operating travel	Approx. 6mm  (Push-lock type: Approx. 9mm, operation angle: Approx. 45°)	Approx. 9mm  (Operation angle: Approx. 45°)	Approx. 9mm	2-position: Approx. 90° 3-position: Approx. 45° 4-position: Approx. 40° 5-position: Approx. 30°	3-position: Approx. 45°	2-position: Approx. 60° 3-position: Approx. 45°
Required return force	– (Push-lock type: 0.6N•m)	0.6N•m	30N (pull)	0.15N•m	0.13N•m	–

Notes: \*1 AR30V2R type: 45N  
\*2 4-position, 5-position: 2NO+2NC

#### ■ Lamp ratings

##### •Illuminated pushbuttons, illuminated selectors, pilot lights (round type)

Transformer	Lamp voltage	LED (lamp base: BA9S/13)			Incandescent (lamp base: BA9S/13)		
		Type	Rated voltage	Consumption	Type	Rated voltage	Consumption
Without transformer	5.5V AC/DC	–	–	–	AHX135	6.3V AC/DC	0.9W
	6V AC	APX510-6□	6V AC	Green, red, orange, amber: 7mA AC Yellow: 26mA AC Blue: 16mA AC	–	–	–
	6V DC	APX510-D6□	6V DC	Green, red, orange, amber: 11mA DC Yellow: 33mA DC Blue: 22mA DC	–	–	–
	12V AC/DC	APX510-12□	12V AC/DC	14mA AC, 11mA DC	–	–	–
	15V AC/DC	APX510-15□	15V AC/DC	13mA AC, 11mA DC	AHX279	18V AC/DC	0.8W
Without transformer	20V AC/DC	–	–	–	AHX144	24V AC/DC	0.9W
	24V AC/DC	APX510-24□	24V AC/DC	12mA AC, 11mA DC	AHX129	30V AC/DC	0.8W
With transformer (Standard type: AR9T511)	110V AC	APX510-6□	6V AC	1.5VA	AHX135	6.3V AC/DC	2VA
	127V AC						2VA
	220V AC						2VA
	254V AC	APX510-6□	6V AC	2.5VA	AHX135	6.3V AC/DC	2.5VA
	380V AC						2.5VA
With transformer (Standard type: AR9T511)	440V AC						2.5VA
	480V AC						2.5VA
	550V AC						2.5VA
With resistor unit (AR9T519-H)	110V DC	APX510-24□	24V AC/DC	1.2W	–	–	–

Notes: • Short body pilot lights: 110V AC, 127V AC, 220V AC only  
• Replace the □ mark by the lamp luminous color code, see page 70

#### •Pilot lights with resistor

Lamp Voltage	LED (lamp base: E12/15)			Incandescent (lamp base: E12/15)		
	Type	Rated voltage	Consumption	Type	Rated voltage	Consumption
50V DC	APX507-24□ *	24V AC/DC	0.8W	AHX130	18V AC/DC	5W
110V DC			1.7W			10W
220V DC			3.3W			20W

Notes: \* White: APX509-24O  
• Replace the □ mark by the lamp luminous color code, see page 70

# Pushbuttons/Selectors/Pilot Lights/Buzzers

## AR30 and DR30

### Ratings and specifications

#### •Pilot lights (DR30F4M, F4N, M4M types)

Transformer	Lamp voltage	LED (lamp base: BA9S/13)			Incandescent (lamp base: BA9S/13)		
		Type*	Rated voltage	Consumption	Type	Rated voltage	Consumption
Without transformer	5.5V AC/DC	–	–	–	AHX135	6.3V AC/DC	0.9W
	6V DC	DR9Q001-6□ DR9Q002-6□ DR9Q003-6□	6V DC	Yellow, orange, amber: 120mA DC Red: 48mA DC	–	–	–
	12V AC	DR9Q001-2□ DR9Q002-2□ DR9Q003-2□	12V AC	Yellow, orange, amber: 90mA AC Red: 25mA AC	–	–	–
	12V AC/DC	DR9Q001-B□ DR9Q002-B□ DR9Q003-B□	12V AC/DC	Yellow, orange, amber: 84mA AC, 60mA DC Red: 27mA AC, 24mA DC	–	–	–
	15V AC/DC	–	–	–	AHX279	20V AC/DC	0.8W
	20V AC/DC	–	–	–	AHX144	24V AC/DC	0.9W
	24V AC/DC	DR9Q001-E□ DR9Q002-E□ DR9Q003-E□	24V AC/DC	Yellow, orange, amber: 42mA AC, 30mA DC Red: 16mA AC, 12mA DC	AHX129	30V AC/DC	0.8W
With transformer unit (LED: AR9T557) (Incandescent: AR9T511)	110V AC	DR9Q001-2□ DR9Q002-2□ DR9Q003-2□	12V AC	3VA	AHX135	6.3V AC/DC	2VA
	127V AC						2VA
	220V AC						2VA
	254V AC						2.5VA
	380V AC						2.5VA
	440V AC						2.5VA
	480V AC						2.5VA
	550V AC						2.5VA
With resistor unit (AR9T519-H)	110V DC	DR9Q001-E□ DR9Q002-E□ DR9Q003-E□	24V AC/DC	1.4W	–	–	–

Notes: \* DR9Q001: For DR30M4M type  
 DR9Q002: For DR30F4N type  
 DR9Q003: For DR30F4M type  
 • Replace the □ mark by the lamp luminous color code, see page 70

# Pushbuttons/Selectors/Pilot Lights/Buzzers

## AR30 and DR30

### Ratings and specifications

#### ■ Lamp durability

Lamp	Durability	Judgement criterion
LED	Approx. 30000h	When brightness is less than 50% of initial value
Incandescent	Approx. 5000h (AC)	When the bulb burns out

Note: The operating voltage for incandescent lamps is set at 80 to 90% of the lamp's rated voltage.

#### Estimated durability for LED lamps

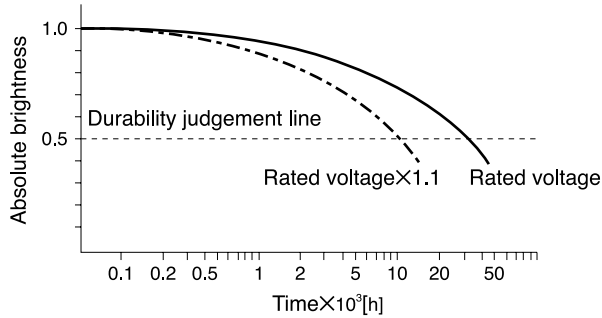

Notes: • Durability at  $T_a=25^{\circ}\text{C}$   
• Durability is affected by temperature, humidity, and voltage fluctuation.

#### Incandescent lamp voltage characteristics

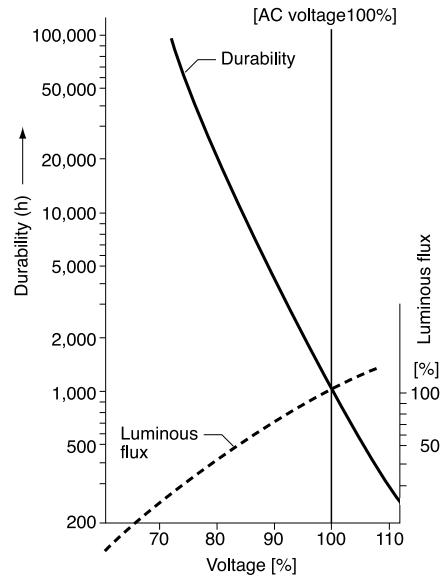





#### ■ Combination of lens color and LED luminous color

Button color (lens or color plate)		LED lamp (high-brightness)			LED unit			
Color	Code	Luminous color	Type	Type *1	Luminous color	Type *2	Type *3	Type *4
Green	G	Green	APX510-■G	APX507-24G	Yellow	DR9Q003-■Y	DR9Q002-■Y	DR9Q001-■Y
Red	R	Red	APX510-■R	APX507-24R	Red	DR9Q003-■R	DR9Q002-■R	DR9Q001-■R
White	W	Orange	APX510-■O	APX509-24O	Orange	DR9Q003-■O	DR9Q002-■O	DR9Q001-■O
Yellow	Y	Yellow	APX510-■Y	APX507-24Y	Yellow	DR9Q003-■Y	DR9Q002-■Y	DR9Q001-■Y
Orange	A	Amber	APX510-■A	APX507-24A	Amber	DR9Q003-■A	DR9Q002-■A	DR9Q001-■A
Blue	S	Blue	APX510-■S	APX507-24S	—	—	—	—

Notes: \*1 For pilot light with resistor  
\*2 For DR30F4M type  
\*3 For DR30F4N type  
\*4 For DR30M4M type  
• Replace the ■ mark by the lamp voltage code, see page 68, 69



## ■ Illuminated pushbutton switches

Operator	Transformer	Contact	LED lamp Momentary action Type	Alternate action Type	Incandescent lamp Momentary action Type	Alternate action Type
Extended round head   AF95-4	Without	1NO 1NC 1NO+1NC 2NO+2NC	AR30E0L-10■3□ AR30E0L-01■3□ AR30E0L-11■3□ AR30E0L-22■3□	AR30E5L-10■3□ AR30E5L-01■3□ AR30E5L-11■3□ —	AR30E0L-10■4□ AR30E0L-01■4□ AR30E0L-11■4□ AR30E0L-22■4□	AR30E5L-10■4□ AR30E5L-01■4□ AR30E5L-11■4□ —
	With	1NO 1NC 1NO+1NC	AR30E0L-10■3□ AR30E0L-01■3□ AR30E0L-11■3□	AR30E5L-10■3□ AR30E5L-01■3□ AR30E5L-11■3□	AR30E0L-10■4□ AR30E0L-01■4□ AR30E0L-11■4□	AR30E5L-10■4□ AR30E5L-01■4□ AR30E5L-11■4□
Extended with transparent full guard (24mm dia.)   KKD05-164	Without	1NO 1NC 1NO+1NC 2NO+2NC	AR30G4L-10■3□ AR30G4L-01■3□ AR30G4L-11■3□ AR30G4L-22■3□	AR30G9L-10■3□ AR30G9L-01■3□ AR30G9L-11■3□ —	AR30G4L-10■4□ AR30G4L-01■4□ AR30G4L-11■4□ AR30G4L-22■4□	AR30G9L-10■4□ AR30G9L-01■4□ AR30G9L-11■4□ —
	With	1NO 1NC 1NO+1NC	AR30G4L-10■3□ AR30G4L-01■3□ AR30G4L-11■3□	AR30G9L-10■3□ AR30G9L-01■3□ AR30G9L-11■3□	AR30G4L-10■4□ AR30G4L-01■4□ AR30G4L-11■4□	AR30G9L-10■4□ AR30G9L-01■4□ AR30G9L-11■4□
Extended with full guard (24mm dia. with openings)   AF99-328	Without	1NO 1NC 1NO+1NC 2NO+2NC	AR30G2L-10■3□ AR30G2L-01■3□ AR30G2L-11■3□ AR30G2L-22■3□	AR30G7L-10■3□ AR30G7L-01■3□ AR30G7L-11■3□ —	AR30G2L-10■4□ AR30G2L-01■4□ AR30G2L-11■4□ AR30G2L-22■4□	AR30G7L-10■4□ AR30G7L-01■4□ AR30G7L-11■4□ —
	With	1NO 1NC 1NO+1NC	AR30G2L-10■3□ AR30G2L-01■3□ AR30G2L-11■3□	AR30G7L-10■3□ AR30G7L-01■3□ AR30G7L-11■3□	AR30G2L-10■4□ AR30G2L-01■4□ AR30G2L-11■4□	AR30G7L-10■4□ AR30G7L-01■4□ AR30G7L-11■4□
Extended with full guard (24mm dia.)   AF95-6	Without	1NO 1NC 1NO+1NC 2NO+2NC	AR30G3L-10■3□ AR30G3L-01■3□ AR30G3L-11■3□ AR30G3L-22■3□	AR30G8L-10■3□ AR30G8L-01■3□ AR30G8L-11■3□ —	AR30G3L-10■4□ AR30G3L-01■4□ AR30G3L-11■4□ AR30G3L-22■4□	AR30G8L-10■4□ AR30G8L-01■4□ AR30G8L-11■4□ —
	With	1NO 1NC 1NO+1NC	AR30G3L-10■3□ AR30G3L-01■3□ AR30G3L-11■3□	AR30G8L-10■3□ AR30G8L-01■3□ AR30G8L-11■3□	AR30G3L-10■4□ AR30G3L-01■4□ AR30G3L-11■4□	AR30G8L-10■4□ AR30G8L-01■4□ AR30G8L-11■4□
Push-lock, turn-reset (40mm dia. with white arrow)   AF97-75	Without	1NO 1NC 1NO+1NC 2NO 2NC 3NC	— — — — — —	AR30V5L-10■3□ AR30V5L-01■3□ AR30V5L-11■3□ AR30V5L-20■3□ AR30V5L-02■3□ AR30V5L-03■3□	— — — — — —	AR30V5L-10■4□ AR30V5L-01■4□ AR30V5L-11■4□ AR30V5L-20■4□ AR30V5L-02■4□ AR30V5L-03■4□
	With	1NO 1NC 1NO+1NC 2NO 2NC	— — — — —	AR30V5L-10■3□ AR30V5L-01■3□ AR30V5L-11■3□ AR30V5L-20■3□ AR30V5L-02■3□	— — — — —	AR30V5L-10■4□ AR30V5L-01■4□ AR30V5L-11■4□ AR30V5L-20■4□ AR30V5L-02■4□
Push-pull (35mm dia.)   AF96-185	Without	1NO+1NC	AR30Q7L-11■3□	—	AR30Q7L-11■4□	—
	With	1NO+1NC	AR30Q7L-11■3□	—	AR30Q7L-11■4□	—

Note: ■ □ See page 72

# Illuminated Pushbuttons

## AR30

### •Lens color

Replace the □ mark by the lens color code

Color	Green	Red	White	Blue	Yellow	Orange
Code	G	R	W	S	Y	A

Note: AR30V5L type: Red, yellow only

### •Contact arrangements

Contact arrangements other than above are available

Contact arrangement	1NO	1NC	1NO+1NC	2NO	2NC	3NO
Code	10	01	11	20	02	30

Contact arrangement	3NC	2NO+2NC	4NO	4NC	5NO	5NC	3NO+3NC
Code	03	22	40	04	50	05	33

Note: AR30Q7L type: 1NO + 1NC only

### Available numbers of contact blocks

Operation	Without transformer	With transformer
Momentary action	6-contact block	4-contact block
Alternate action Push-lock, turn-reset	3-contact block	2-contact block

### •Contact operation (AR30Q7L)

Contact block		Button position		
No.	Type	Pull	Free	Push
(1)	NC	●		
(2)	NC	■		

● Contact closed

### •Voltage

Replace the ■ mark by the lamp voltage code

Transformer		Code	
		LED	Incandescent
Without transformer	6V DC	6	—
	6V AC	A	—
	5.5V AC/DC	—	5
	12V AC/DC	B	—
	15V AC/DC	C	C
	20V AC/DC 24V AC/DC	— E	D E
With transformer	100-110V AC	H	H
	115-127V AC	L	L
	200-220V AC	M	M
	230-254V AC	Q	Q
	350-380V AC	S	S
	400-440V AC	T	T
	480V AC	V	V
	500-550V AC	W	W

### •Position of contact block



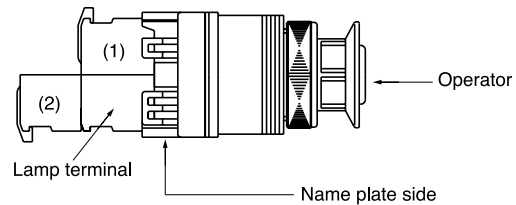

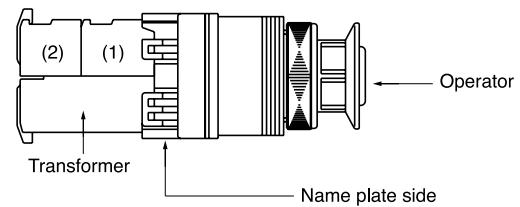

AR30Q7L (without transformer)



AR30Q7L (with transformer)





■ Pushbutton switches



Operator	Contact	Momentary action Type	Alternate action Type
Flush round head  AF95-11	1NO 1NC 1NO+1NC 2NO 2NC 2NO+2NC	<b>AR30F0R-10</b> □ <b>AR30F5R-10</b> □ <b>AR30F0R-01</b> □ <b>AR30F5R-01</b> □ <b>AR30F0R-11</b> □ <b>AR30F5R-11</b> □ <b>AR30F0R-20</b> □ <b>AR30F5R-20</b> □ <b>AR30F0R-02</b> □ <b>AR30F5R-02</b> □ <b>AR30F0R-22</b> □ <b>AR30F5R-22</b> □	
Extended round head  AF95-10	1NO 1NC 1NO+1NC 2NO 2NC 2NO+2NC	<b>AR30E0R-10</b> □ <b>AR30E5R-10</b> □ <b>AR30E0R-01</b> □ <b>AR30E5R-01</b> □ <b>AR30E0R-11</b> □ <b>AR30E5R-11</b> □ <b>AR30E0R-20</b> □ <b>AR30E5R-20</b> □ <b>AR30E0R-02</b> □ <b>AR30E5R-02</b> □ <b>AR30E0R-22</b> □ <b>AR30E5R-22</b> □	
Flush round head symbol mark type  AF98-195	1NO 1NC 1NO+1NC 2NO 2NC 2NO+2NC	<b>AR30FAR-10C</b> ■ <b>AR30FBR-10C</b> ■ <b>AR30FAR-01C</b> ■ <b>AR30FBR-01C</b> ■ <b>AR30FAR-11C</b> ■ <b>AR30FBR-11C</b> ■ <b>AR30FAR-20C</b> ■ <b>AR30FBR-20C</b> ■ <b>AR30FAR-02C</b> ■ <b>AR30FBR-02C</b> ■ <b>AR30FAR-22C</b> ■ <b>AR30FBR-22C</b> ■	
Extended round head symbol mark type  AF98-194	1NO 1NC 1NO+1NC 2NO 2NC 2NO+2NC	<b>AR30EAR-10C</b> ■ <b>AR30EBR-10C</b> ■ <b>AR30EAR-01C</b> ■ <b>AR30EBR-01C</b> ■ <b>AR30EAR-11C</b> ■ <b>AR30EBR-11C</b> ■ <b>AR30EAR-20C</b> ■ <b>AR30EBR-20C</b> ■ <b>AR30EAR-02C</b> ■ <b>AR30EBR-02C</b> ■ <b>AR30EAR-22C</b> ■ <b>AR30EBR-22C</b> ■	
Mushroom head (40mm dia.)  AF95-12	1NO 1NC 1NO+1NC 2NO 2NC 2NO+2NC	<b>AR30M0R-10</b> □ <b>AR30M5R-10</b> □ <b>AR30M0R-01</b> □ <b>AR30M5R-01</b> □ <b>AR30M0R-11</b> □ <b>AR30M5R-11</b> □ <b>AR30M0R-20</b> □ <b>AR30M5R-20</b> □ <b>AR30M0R-02</b> □ <b>AR30M5R-02</b> □ <b>AR30M0R-22</b> □ <b>AR30M5R-22</b> □	
Mushroom head (29mm dia.)  AF95-8	1NO 1NC 1NO+1NC 2NO 2NC 2NO+2NC	<b>AR30M4R-10</b> □ — <b>AR30M4R-01</b> □ — <b>AR30M4R-11</b> □ — <b>AR30M4R-20</b> □ — <b>AR30M4R-02</b> □ — <b>AR30M4R-22</b> □ —	
Extended with full guard (24mm dia.)  AF95-16	1NO 1NC 1NO+1NC 2NO 2NC 2NO+2NC	<b>AR30G1R-10</b> □ <b>AR30G6R-10</b> □ <b>AR30G1R-01</b> □ <b>AR30G6R-01</b> □ <b>AR30G1R-11</b> □ <b>AR30G6R-11</b> □ <b>AR30G1R-20</b> □ <b>AR30G6R-20</b> □ <b>AR30G1R-02</b> □ <b>AR30G6R-02</b> □ <b>AR30G1R-22</b> □ <b>AR30G8R-22</b> □	

Note: ■ □ See page 74

Operator	Contact	Momentary action Type	Alternate action Type
Extended with half guard  AF95-9	1NO 1NC 1NO+1NC 2NO 2NC 2NO+2NC	<b>AR30G0R-10</b> □ <b>AR30G5R-10</b> □ <b>AR30G0R-01</b> □ <b>AR30G5R-01</b> □ <b>AR30G0R-11</b> □ <b>AR30G5R-11</b> □ <b>AR30G0R-20</b> □ <b>AR30G5R-20</b> □ <b>AR30G0R-02</b> □ <b>AR30G5R-02</b> □ <b>AR30G0R-22</b> □ <b>AR30G5R-22</b> □	
Pin lock  AF96-240	1NO 1NC 1NO+1NC 2NO 2NC 2NO+2NC	<b>AR30GPR-10</b> □ — <b>AR30GPR-01</b> □ — <b>AR30GPR-11</b> □ — <b>AR30GPR-20</b> □ — <b>AR30GPR-02</b> □ — <b>AR30GPR-22</b> □ —	
Mushroom head with full guard (40mm dia.)  AF95-17	1NO 1NC 1NO+1NC 2NO 2NC 2NO+2NC	<b>AR30M3R-10</b> □ <b>AR30M8R-10</b> □ <b>AR30M3R-01</b> □ <b>AR30M8R-01</b> □ <b>AR30M3R-11</b> □ <b>AR30M8R-11</b> □ <b>AR30M3R-20</b> □ <b>AR30M8R-20</b> □ <b>AR30M3R-02</b> □ <b>AR30M8R-02</b> □ <b>AR30M3R-22</b> □ <b>AR30M8R-22</b> □	
Mushroom head with full guard (35mm dia. metal nut)  AF96-239	1NO 1NC 1NO+1NC 2NO 2NC 2NO+2NC	<b>AR30GSR-10</b> □ — <b>AR30GSR-01</b> □ — <b>AR30GSR-11</b> □ — <b>AR30GSR-20</b> □ — <b>AR30GSR-02</b> □ — <b>AR30GSR-22</b> □ —	
Giant head  AF95-579	1NO 1NC 1NO+1NC 2NO 2NC 2NO+2NC	<b>AR30B0R-10</b> □ — <b>AR30B0R-01</b> □ — <b>AR30B0R-11</b> □ — <b>AR30B0R-20</b> □ — <b>AR30B0R-02</b> □ — <b>AR30B0R-22</b> □ —	
Giant head with guard  AF95-582	1NO 1NC 1NO+1NC 2NO 2NC 2NO+2NC	<b>AR30B1R-10</b> □ — <b>AR30B1R-01</b> □ — <b>AR30B1R-11</b> □ — <b>AR30B1R-20</b> □ — <b>AR30B1R-02</b> □ — <b>AR30B1R-22</b> □ —	
Giant head with full guard  AF95-580	1NO 1NC 1NO+1NC 2NO 2NC 2NO+2NC	<b>AR30B2R-10</b> □ — <b>AR30B2R-01</b> □ — <b>AR30B2R-11</b> □ — <b>AR30B2R-20</b> □ — <b>AR30B2R-02</b> □ — <b>AR30B2R-22</b> □ —	

# Pushbuttons AR30

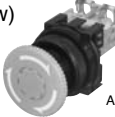
Operator	Contact	Momentary action Type	Alternate action Type
Giant head with full guard  <small>AF95-581</small>	1NO	<b>AR30B3R-10</b> □ —	
	1NC	<b>AR30B3R-01</b> □ —	
	1NO+1NC	<b>AR30B3R-11</b> □ —	
	2NO	<b>AR30B3R-20</b> □ —	
	2NC	<b>AR30B3R-02</b> □ —	
	2NO+2NC	<b>AR30B3R-22</b> □ —	
Push, turn-lock  <small>AF95-583</small>	1NO	<b>AR30N0R-10</b> □ —	
	1NC	<b>AR30N0R-01</b> □ —	
	1NO+1NC	<b>AR30N0R-11</b> □ —	
	2NO	<b>AR30N0R-20</b> □ —	
	2NC	<b>AR30N0R-02</b> □ —	
	2NO+2NC	<b>AR30N0R-22</b> □ —	

Operator	Contact	Momentary action Type	Alternate action Type
Push-lock, turn-reset (40mm dia. with white arrow)  <small>AF97-69</small>	1NO	—	<b>AR30V5R-10</b> □
	1NC	—	<b>AR30V5R-01</b> □
	1NO+1NC	—	<b>AR30V5R-11</b> □
	2NO	—	<b>AR30V5R-20</b> □
	2NC	—	<b>AR30V5R-02</b> □
	2NO+2NC	—	<b>AR30V5R-22</b> □
Pushbutton with emergency operating cap  <small>AF96-187</small>	1NO	<b>AR30FVR-10</b> □ —	
	1NC	<b>AR30FVR-01</b> □ —	
	1NO+1NC	<b>AR30FVR-11</b> □ —	
	2NO	<b>AR30FVR-20</b> □ —	
	2NC	<b>AR30FVR-02</b> □ —	
	2NO+2NC	<b>AR30FVR-22</b> □ —	

### •Button color

Replace the □ mark by the button color code

Color	Green	Red	White	Blue	Yellow	Orange	Black
Code	G	R	W	S	Y	A	B

Note: AR30V5R type: Red, yellow, black only

### •Available numbers of contact blocks

Momentary action	Alternate action Push-lock, turn-reset
8-contact block	4-contact block

### •Contact arrangements

Contact arrangements other than above are available

Contact arrangement	1NO	1NC	1NO+1NC	2NO	2NC	3NO	3NC
Code	10	01	11	20	02	30	03

Contact arrangement	2NO+2NC	4NO	4NC	5NO	5NC	3NO+3NC	4NO+4NC
Code	22	40	04	50	05	33	44

### •Symbol mark (For AR30FAR, FBR, EAR, EBR)

Replace the ■ mark by the symbol mark code

Symbol mark	○	I	⊕	○	I	⊕
Color of button	White   Black	White   Black	White   Black	White   Black	White   Black	Clear
Color of mark	Red	Green	Green	Green	Black	
Code	01   02	03   04	11   12	02B   04B	12B	

Operator	Contact (The following contact is only available.)	Button color	Type	Contact operation					
				Contact block		Left		Right	
				Mounting position	Type	Free	Depressed	Free	Depressed
Pushbutton with selector ring (2-position)   AF97-506	2NO+2NC	Green Red Black White Yellow Orange Blue	<b>AR30S1R-22G</b> <b>AR30S1R-22R</b> <b>AR30S1R-22B</b> <b>AR30S1R-22W</b> <b>AR30S1R-22Y</b> <b>AR30S1R-22A</b> <b>AR30S1R-22S</b>	(1)	NC	—	—	●	—
				(2)	NC	—	—	●	—
				(3)	NO	—	●	—	●
				(4)	NO	—	●	—	●
	2NO	Green Red Black White Yellow Orange Blue	<b>AR30S2R-20G</b> <b>AR30S2R-20R</b> <b>AR30S2R-20B</b> <b>AR30S2R-20W</b> <b>AR30S2R-20Y</b> <b>AR30S2R-20A</b> <b>AR30S2R-20S</b>	(1)	NO	—	●	—	—
				(2)	NO	—	—	—	●
				(3)	NO	—	—	—	—
				(4)	NO	—	—	—	—
	2NO+2NC	Green Red Black White Yellow Orange Blue	<b>AR30S2R-22G</b> <b>AR30S2R-22R</b> <b>AR30S2R-22B</b> <b>AR30S2R-22W</b> <b>AR30S2R-22Y</b> <b>AR30S2R-22A</b> <b>AR30S2R-22S</b>	(1)	NC	●	—	██████████	
				(2)	NC	██████████		●	—
				(3)	NO	—	●	—	—
				(4)	NO	—	—	—	●
	2NO+2NC	Green Red Black White Yellow Orange Blue	<b>AR30S3R-22G</b> <b>AR30S3R-22R</b> <b>AR30S3R-22B</b> <b>AR30S3R-22W</b> <b>AR30S3R-22Y</b> <b>AR30S3R-22A</b> <b>AR30S3R-22S</b>	(1)	NC	—	—	██████████	
				(2)	NC	██████████		—	—
				(3)	NO	—	●	—	—
				(4)	NO	—	—	—	●
	2NO+2NC	Green Red Black White Yellow Orange Blue	<b>AR30S6R-22G</b> <b>AR30S6R-22R</b> <b>AR30S6R-22B</b> <b>AR30S6R-22W</b> <b>AR30S6R-22Y</b> <b>AR30S6R-22A</b> <b>AR30S6R-22S</b>	(1)	NC	●	—	—	Locked
				(2)	NC	●	—	—	
				(3)	NO	—	●	●	
				(4)	NO	—	●	●	

Note: (1) to (4): Contact block mounting position

● Contact closed  
— Contact open

•Position of contact block

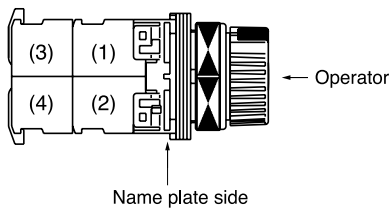





Notes: Contact block color  
NC: red  
NO: blue

# Emergency Stop Pushbuttons

## AR30

### ■ Emergency stop pushbutton switches

⊙ (Direct opening action), conform to EN418

Operator	Contact	Type
Push-lock, turn-reset (Soft-touch 40mm dia. with white arrow)  <small>AF97-69</small>	1NC 1NO+1NC 2NC 1NO+3NC 2NO+2NC	<b>AR30V0R-01R</b> <b>AR30V0R-11R</b> <b>AR30V0R-02R</b> <b>AR30V0R-13R</b> <b>AR30V0R-22R</b>
Push-lock, turn-reset (40mm dia.)  <small>AF95-176</small>	1NC 1NO+1NC 2NC 1NO+3NC 2NO+2NC	<b>AR30V2R-01R</b> <b>AR30V2R-11R</b> <b>AR30V2R-02R</b> <b>AR30V2R-13R</b> <b>AR30V2R-22R</b>
Push-lock, turn-reset (Soft-touch 65mm dia. with white arrow)  <small>AF97-68</small>	1NC 1NO+1NC 2NC 1NO+3NC 2NO+2NC	<b>AR30V1R-01R</b> <b>AR30V1R-11R</b> <b>AR30V1R-02R</b> <b>AR30V1R-13R</b> <b>AR30V1R-22R</b>
Push-lock, pull-reset (35mm dia.)  <small>AF95-3</small>	1NC 1NO+1NC 2NC	<b>AR30Q2R-01R</b> <b>AR30Q2R-11R</b> <b>AR30Q2R-02R</b>

Note: Button color: Red only

### •Contact arrangements



Contact arrangements other than above are available

Contact arrangement	1NO	1NO+1NC	2NC	3NC	2NO+2NC	4NC	1NO+3NC
Code	01	11	02	03	22	04	13

Notes: • Except AR30Q2R  
 • For push-lock, pull-reset type, up to 2-contact block.

## ■ Emergency stop illuminated pushbutton switches

⇒ (Direct opening action), conform to EN418

Operator	Transformer	Contact	LED lamp Type	Incandescent lamp Type
Push-lock, turn-reset (Soft-touch 40mm dia. with white arrow)  <small>AF97-75</small>	Without	1NC 1NO+1NC 2NC 1NO+2NC 3NC	AR30V0L-01■3R AR30V0L-11■3R AR30V0L-02■3R AR30V0L-12■3R AR30V0L-03■3R	AR30V0L-01■4R AR30V0L-11■4R AR30V0L-02■4R AR30V0L-12■4R AR30V0L-03■4R
	With	1NC 1NO+1NC 2NC	AR30V0L-01■3R AR30V0L-11■3R AR30V0L-02■3R	AR30V0L-01■4R AR30V0L-11■4R AR30V0L-02■4R
Push-lock, turn-reset (40mm dia.)  <small>AF95-2</small>	Without	1NC 1NO+1NC 2NC 3NC	AR30V2L-01■3R AR30V2L-11■3R AR30V2L-02■3R AR30V2L-03■3R	AR30V2L-01■4R AR30V2L-11■4R AR30V2L-02■4R AR30V2L-03■4R
	With	1NC 1NO+1NC 2NC	AR30V2L-01■3R AR30V2L-11■3R AR30V2L-02■3R	AR30V2L-01■4R AR30V2L-11■4R AR30V2L-02■4R

Notes: • Button color: Red only  
• Contact arrangements indicated in the table can be supplied.

### •Voltage

Replace the ■ mark by the lamp voltage code











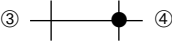

Transformer		Code	
		LED	Incandescent
Without	6V DC	6	—
	6V AC	A	—
	5V AC/DC	—	5
	12V AC/DC	B	—
	15V AC/DC	C	C
	20V AC/DC	—	D
	24V AC/DC	E	E

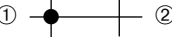
Transformer		Code	
		LED	Incandescent
With	100-110V AC	H	H
	115-127V AC	L	L
	200-220V AC	M	M
	230-254V AC	Q	Q
	350-380V AC	S	S
	400-440V AC	T	T
	480V AC	V	V
	500-550V AC	W	W

# Selector Switches AR30

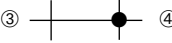
## ■ Selector switches

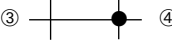
### 2-position

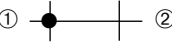
Operator	Operation	Knob color or key removable position	Contact	Type Switch with round bezel	Contact operation (Example)	
					Contact arrangement	Operator position
						Left    Right
				 		
 AF95-13	Maintained  each 90°	Color code: B: Black (Standard) Color other than above are available (G: Green) (R: Red)	1NO 1NC 1NO+1NC 2NO 2NC 2NO+2NC	<b>AR30PR-210B</b> <b>AR30PR-201B</b> <b>AR30PR-211B</b> <b>AR30PR-220B</b> <b>AR30PR-202B</b> <b>AR30PR-222B</b>	1NO (1)	Upper contact  
	Spring return   60°		1NO 1NC 1NO+1NC 2NO 2NC 2NO+2NC	<b>AR30PR-010B</b> <b>AR30PR-001B</b> <b>AR30PR-011B</b> <b>AR30PR-020B</b> <b>AR30PR-002B</b> <b>AR30PR-022B</b>	1NC (1)	Upper contact  
 AF95-14	Maintained  each 90°		1NO 1NC 1NO+1NC 2NO 2NC 2NO+2NC	<b>AR30WR-210B</b> <b>AR30WR-201B</b> <b>AR30WR-211B</b> <b>AR30WR-220B</b> <b>AR30WR-202B</b> <b>AR30WR-222B</b>	(1)	Upper contact  
	Spring return   60°		1NO 1NC 1NO+1NC 2NO 2NC 2NO+2NC	<b>AR30WR-010B</b> <b>AR30WR-001B</b> <b>AR30WR-011B</b> <b>AR30WR-020B</b> <b>AR30WR-002B</b> <b>AR30WR-022B</b>	2NO+2NC	Upper contact  
 AF95-15	Maintained  each 90°	■: Key removable position ( ): Key type  <i>See page 04/83</i>	1NO 1NC 1NO+1NC 2NO 2NC 2NO+2NC	<b>AR30J□R-2■10( )</b> <b>AR30J□R-2■01( )</b> <b>AR30J□R-2■11( )</b> <b>AR30J□R-2■20( )</b> <b>AR30J□R-2■02( )</b> <b>AR30J□R-2■22( )</b>	(3)	Upper contact  
	Spring return   60°		1NO 1NC 1NO+1NC 2NO 2NC 2NO+2NC	<b>AR30J□R-0A10( )</b> <b>AR30J□R-0A01( )</b> <b>AR30J□R-0A11( )</b> <b>AR30J□R-0A20( )</b> <b>AR30J□R-0A02( )</b> <b>AR30J□R-0A22( )</b>	(4)	Lower contact  

Notes: • (1) to (4): Contact block mounting position

• ① – ②, ③ – ④: Contact block terminal No.

• Contact arrangements: *See page 80*

● Contact closed

### • Operator

Replace the □ mark by the cylinder key type code

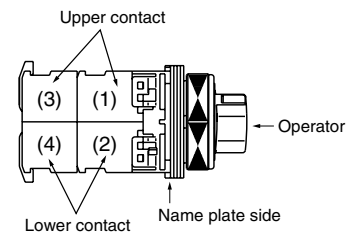

Standard type:    Blank

Long durability type: A





## 3-position

Operator	Operation	Knob color	Contact	Type Switch with round bezel	Contact operation (Example)		
					Contact arrangement	Operation position	
						L C R	L C R
						⤵ ① ⤴	⤵ ① ⤴
 <p>AF95-13</p>	Maintained each 45°	Color code: B: Black (Standard) Color other than above are available (G: Green) (R: Red)	1NO+1NC 2NO 2NC 2NO+2NC	<b>AR30PR-311B</b> <b>AR30PR-320B</b> <b>AR30PR-302B</b> <b>AR30PR-322B</b>	1NO+1NC (1) (2)	Upper contact ③	Lower contact ①
	Spring/manual return ① each 45°		1NO+1NC 2NO 2NC 2NO+2NC			<b>AR30PR-611B</b> <b>AR30PR-620B</b> <b>AR30PR-602B</b> <b>AR30PR-622B</b>	③
	Spring/manual return ① each 45°		1NO+1NC 2NO 2NC 2NO+2NC	<b>AR30PR-711B</b> <b>AR30PR-720B</b> <b>AR30PR-702B</b> <b>AR30PR-722B</b>	③		②
	Spring return ① each 45°		2NO+2NC		<b>AR30PR-122B</b>	①	②
						③	④
 <p>AF95-14</p>	Maintained each 45°		1NO+1NC 2NO 2NC 2NO+2NC	<b>AR30WR-311B</b> <b>AR30WR-320B</b> <b>AR30WR-302B</b> <b>AR30WR-322B</b>	1NO+1NC (1) (2)	Upper contact ③	Lower contact ①
	Spring/manual return ① each 45°		1NO+1NC 2NO 2NC 2NO+2NC			<b>AR30WR-611B</b> <b>AR30WR-620B</b> <b>AR30WR-602B</b> <b>AR30WR-622B</b>	③
	Spring/manual return ① each 45°		1NO+1NC 2NO 2NC 2NO+2NC	<b>AR30WR-711B</b> <b>AR30WR-720B</b> <b>AR30WR-702B</b> <b>AR30WR-722B</b>	③		②
	Spring return ① each 45°		2NO+2NC		<b>AR30WR-122B</b>	①	②
						③	④

Note: • Contact arrangements: See page 80

● Contact closed

# Selector Switches AR30

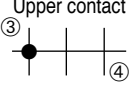
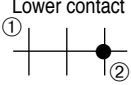
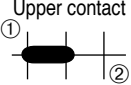
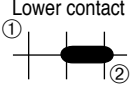
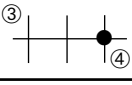
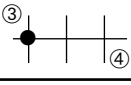
Operator	Operation	Key removable position	Contact	Type Switch with round bezel	Contact operation (Example)			
					Contact arrangement	Operator position		
						L	C	R
 AF95-15	Maintained each 45°	■: Key removable position ( ): Key type	1NO+1NC 2NO 2NC 2NO+2NC	AR30J□R-3■11( ) AR30J□R-3■20( ) AR30J□R-3■02( ) AR30J□R-3■22( )	1NO+1NC (1) (2)	 Upper contact  Lower contact		
	Spring/manual return ① each 45°		1NO+1NC 2NO 2NC 2NO+2NC	AR30J□R-6■11( ) AR30J□R-6■20( ) AR30J□R-6■02( ) AR30J□R-6■22( )				
	Spring/manual return ① each 45°		1NO+1NC 2NO 2NC 2NO+2NC	AR30J□R-7■11( ) AR30J□R-7■20( ) AR30J□R-7■02( ) AR30J□R-7■22( )				
	Spring return ① each 45°		2NO+2NC	AR30J□R-1E22( )	2NO+2NC (1) (2) (3) (4)	 Upper contact  Lower contact  		

Notes: • Operator position L: Left, C: Center, R: Right

• (1) to (4): Contact block mounting position

• ①-②, ③-④: Contact block terminal No.

● Contact closed

### • Contact arrangements

Contact arrangements other than above are available







Contact arrangement	1NO	1NC	1NO+1NC	2NO	2NC	3NO	3NC
Code	10	01	11	20	02	30	03

Contact arrangement	2NO+2NC	4NO	4NC	5NO	5NC	3NO+3NC	4NO+4NC
Code	22	40	04	50	05	33	44

### • Available numbers of contact blocks

Maintained	Spring return Spring/manual return
8-contact block	4-contact block

### • Key removable positions

Code	A	B	C	D	E	F	G
Removable position							
AR30J□R-2	●	●	-	●	-	-	-
AR30J□R-0	●	-	-	-	-	-	-
AR30J□R-3	●	●	●	●	●	●	●
AR30J□R-6	-	-	-	●	●	●	-
AR30J□R-7	●	-	-	-	●	-	●
AR30J□R-1	-	-	-	-	●	-	-

●: Available    -: Not available

### • Position of contact block

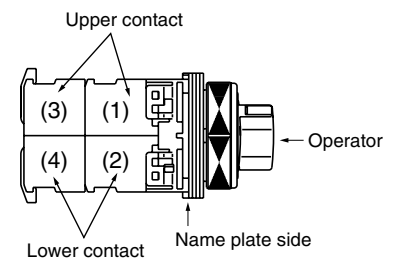

### • Key code No.

Replace the ( ) mark with one of the following key code.

A, B, C, D, E and F

Standard key code is A.

### • Operator













Replace the □ mark by the cylinder key type code

Standard type: Blank







Long durability type: A

## ■ Selector switches (control type)

### 3-position

Operator	Operation	Knob color or key removable position	Contact arrangement	Type Switch with round bezel
Knob  <small>AF95-475</small>	Maintained each 45°	Color code: B: Black (Standard) Color other than above are available (G: Green) (R: Red )	Replace the ■ mark by the contact arrangement code (shown on next page).	<b>AR30PCR-3■B</b>
	Spring/manual return  each 45°			<b>AR30PCR-6■B</b>
	Spring/manual return  each 45°			<b>AR30PCR-7■B</b>
	Spring return  each 45°			<b>AR30PCR-1■B</b>
Lever  <small>KK02-140A</small>	Maintained each 45°		Replace the ■ mark by the contact arrangement code (shown on next page).	<b>AR30WCR-3■B</b>
	Spring/manual return  each 45°			<b>AR30WCR-6■B</b>
	Spring/manual return  each 45°			<b>AR30WCR-7■B</b>
	Spring return  each 45°			<b>AR30WCR-1■B</b>
Key  <small>AF95-474</small>	Maintained each 45°	Replace the □ mark by the key removable position code: A, B, C, D, E F or G	Replace the ■ mark by the contact arrangement code (shown on next page).	<b>AR30JCR-3□■( )</b>
	Spring/manual return  each 45°			<b>AR30JCR-6□■( )</b>
	Spring/manual return  each 45°			<b>AR30JCR-7□■( )</b>
	Spring return  each 45°			<b>AR30JCR-1E■( )</b>

### • Key removable positions

Code	A	B	C	D	E	F	G
Removable position							
AR30JCR-3	●	●	●	●	●	●	●
AR30JCR-6	—	—	—	●	●	●	—
AR30JCR-7	●	—	—	—	●	—	●
AR30JCR-1	—	—	—	—	●	—	—

●: Available    —: Not available

### •Key code No.

Replace the ( ) mark with one of the following key code.  
 A, B, C, D, E and F  
 Standard key code is A.

# Selector Switches AR30

## • Contact arrangement code (Typical example)

Contact arrangement	Contact arrangement code	Contact operation				
		Contact block		Operator position		
		Mounting position	Type	Left	Center	Right
2NC	01F	(1)	NC	[Solid bar]		
		(2)	NC		[Solid bar]	
		-	-	-	-	-
		-	-	-	-	-
2NO+2NC	014	(1)	NC	[Solid bar]		
		(2)	NC		[Solid bar]	
		(3)	NO			●
		(4)	NO	●		
4NC	01J	(1)	NC	[Solid bar]		
		(2)	NC		[Solid bar]	
		(3)	NC	[Solid bar]		
		(4)	NC		[Solid bar]	
2NO+2NC	024	(1)	NC	[Solid bar]		
		(2)	NC		●	
		(3)	NO			●
		(4)	NO	●		●
2NO+2NC	03C* (Maintained only)	(1)	NC	[Solid bar]		
		(2)	NC			●
		(3)	NO			●
		(4)	NO	●		
2NO+2NC	044*	(1)	NC	[Solid bar]		
		(2)	NC		●	
		(3)	NO			●
		(4)	NO	●		
2NO+2NC	054	(1)	NC	[Solid bar]		
		(2)	NC		●	
		(3)	NO			●
		(4)	NO			●

Notes: ●: Contact closed Blank: Contact open  
\* There may be some overlap in the contact when switching between notches.

## • Position of contact block

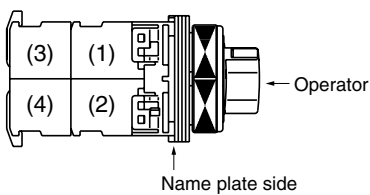

Contact arrangement	Contact arrangement code	Contact operation				
		Contact block		Operator position		
		Mounting position	Type	Left	Center	Right
2NO+2NC	064	(1)	NC		[Solid bar]	
		(2)	NC		●	
		(3)	NO	●		
		(4)	NO	●		●
1NO+1NC	07F	(1)	NC		[Solid bar]	
		(2)	NO			●
		-	-	-	-	-
		-	-	-	-	-
2NO+2NC	07C* (Maintained only)	(1)	NC		[Solid bar]	
		(2)	NC			●
		(3)	NO	●		
		(4)	NO	●		
2NO+2NC	084	(1)	NC		[Solid bar]	
		(2)	NC		●	
		(3)	NO	●		
		(4)	NO	●		
2NO+2NC	094*	(1)	NC		[Solid bar]	
		(2)	NC		●	
		(3)	NO	●		
		(4)	NO			●
2NO+2NC	104	(1)	NC		●	
		(2)	NC		●	
		(3)	NO	●		●
		(4)	NO	●		●
2NO+2NC	11C* (Maintained only)	(1)	NC		●	
		(2)	NC			●
		(3)	NO	●		●
		(4)	NO	●		

• **Contact arrangement code (Typical example)**

Contact arrangement	Contact arrangement code	Contact operation				
		Contact block		Operator position		
		Mounting position	Type	Left	Center	Right
2NO+2NC	124*	(1)	NC		●	
		(2)	NC		●	
		(3)	NO	●		●
		(4)	NO	●		
2NO+2NC	134*	(1)	NC		●	
		(2)	NC		●	
		(3)	NO	●		●
		(4)	NO			●
3NO+1NC	14D* <small>(Maintained only)</small>	(1)	NO	●		
		(2)	NC		●	
		(3)	NO	●		
		(4)	NO			●
3NO+1NC	15A*	(1)	NO			●
		(2)	NC		●	
		(3)	NO			●
		(4)	NO	●		
2NO+2NC	164	(1)	NC		●	
		(2)	NC		●	
		(3)	NO	●		
		(4)	NO	●		
2NO+2NC	174*	(1)	NC		●	
		(2)	NC		●	
		(3)	NO	●		
		(4)	NO			●
2NO+2NC	184	(1)	NC		●	
		(2)	NC		●	
		(3)	NO			●
		(4)	NO			●

Notes: ●: Contact closed    Blank: Contact open  
 \* There may be some overlap in the contact when switching between notches.

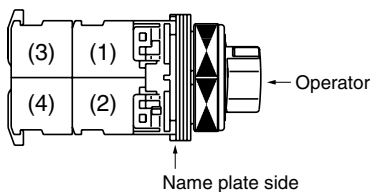

• **Position of contact block**



Contact arrangement	Contact arrangement code	Contact operation				
		Contact block		Operator position		
		Mounting position	Type	Left	Center	Right
2NO+2NC	194	(1)	NC		■■■■■	
		(2)	NC	■■■■■		
		(3)	NO	●		
		(4)	NO			●
4NO	20B	(1)	NO			●
		(2)	NO	●		
		(3)	NO			●
		(4)	NO	●		

# Selector Switches AR30

## 4, 5-position

Operator	Contact (The following contact is only available.)	Operation	Knob color	Contact arrangement	Type Switch with round bezel
Knob  <small>AF95-475</small>	2NO+2NC	4-position maintained	Color code: B: Black (Standard) Color other than above are available (G: Green) (R: Red)	Replace the ■ mark by the contact arrangement code (shown below)	<b>AR30PCR-4■B</b>
		5-position maintained			<b>AR30PCR-5■B</b>
Lever  <small>KK02-140A</small>	2NO+2NC	4-position maintained			<b>AR30WCR-4■B</b>
		5-position maintained			<b>AR30WCR-5■B</b>

### ● Contact arrangement code

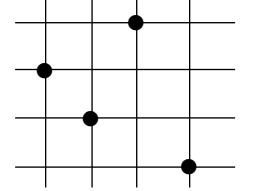
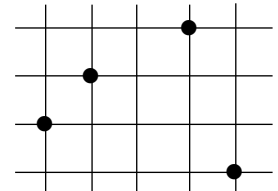
Position	Contact arrangement	Contact arrangement code	Contact operation		Operator position
			Contact block		
			Mounting position	Type	
4-position	2NO+2NC	41C* (Maintained only)	(1)	NC	
			(2)	NC	
			(3)	NO	
			(4)	NO	
5-position	2NO+2NC	51C* (Maintained only)	(1)	NC	
			(2)	NC	
			(3)	NO	
			(4)	NO	

Notes: ●: Contact closed

\* There may be some overlap in the contact when switching between notches.

### • Position of contact block

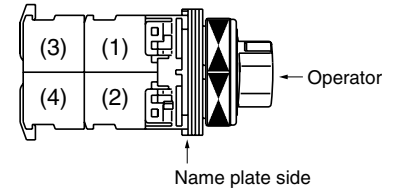

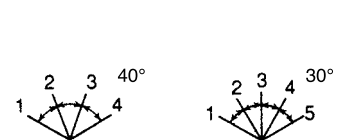

### Operator position







■ Illuminated selector switches

2-position

Operator	Operation	Contact	LED lamp		Incandescent lamp	
			Transformer	Type	Transformer	Type
 AF95-5	Maintained	1NO 1NC 1NO+1NC 2NO+2NC	Without	AR30PL-210■3□	Without	AR30PL-210■4□
				AR30PL-201■3□		AR30PL-201■4□
	each 90°	1NO 1NC 1NO+1NC 2NO	With	AR30PL-211■3□	With	AR30PL-211■4□
				AR30PL-222■3□		AR30PL-222■4□
	 60°	1NO 1NC 1NO+1NC 2NO	Without	AR30PL-010■3□	Without	AR30PL-010■4□
				AR30PL-001■3□		AR30PL-001■4□
 60°	1NO 1NC 1NO+1NC 2NO	With	AR30PL-011■3□	With	AR30PL-011■4□	
			AR30PL-020■3□		AR30PL-020■4□	

3-position

Operator	Operation	Contact	LED lamp		Incandescent lamp	
			Transformer	Type	Transformer	Type
 AF95-5	Maintained	1NO+1NC 2NO+2NC	Without	AR30PL-311■3□	Without	AR30PL-311■4□
				AR30PL-322■3□		AR30PL-322■4□
	 each 45°	1NO+1NC	With	AR30PL-311■3□	With	AR30PL-311■4□
				AR30PL-611■3□		AR30PL-611■4□
	 each 45°	1NO+1NC	Without	AR30PL-611■3□	Without	AR30PL-611■4□
				AR30PL-711■3□		AR30PL-711■4□
 each 45°	1NO+1NC	With	AR30PL-711■3□	With	AR30PL-711■4□	
			AR30PL-711■3□		AR30PL-711■4□	

Note: □, ■ See page 86

# Illuminated Selector Switches AR30

• Replace the ■ mark by the following lamp voltage code

Transformer	Voltage	Code	
		LED	Incandescent
Without	5V AC/DC	—	5
	6V DC	6	—
	6V AC	A	—
	12V AC/DC	B	—
	15V AC/DC	C	C
	20V AC/DC	—	D
	24V AC/DC	E	E
With	100-110V AC	H	H
	115-127V AC	L	L
	200-220V AC	M	M
	230-254V AC	Q	Q
	350-380V AC	S	S
	400-440V AC	T	T
	480V AC	V	V
	500-550V AC	W	W

• Replace the □ mark by the following knob color code

Color	Green	Red	White	Blue	Yellow	Orange
Code	G	R	W	S	Y	A

• Up to 4-contact of contact arrangement can be made.  
Available numbers of contacts are as follow.

No. of position	Operation	Without transformer	With transformer
2-position	Maintained	6-contact	4-contact
	Spring return	3-contact	2-contact
3-position	Maintained	6-contact	4-contact
	Spring/manual return	3-contact	2-contact

## ● Contact arrangement and operator position 2-position

Transformer	Contact arrangement	Contact block		Operator position	
		Mounting position	Type	Left	Right
				⊖	⊕
With/without	1NO	(1)	NO	—	●
With/without	1NC	(1)	NC	●	—
Without	1NO+1NC	(1)	NO	—	●
		(2)	NC	●	—
With	1NO+1NC	(1)	NC	●	—
		(2)	NO	—	●
With/without	2NO	(1)	NO	—	●
		(2)	NO	—	●
Without	2NO+2NC *1	(1)	NO	—	●
		(2)	NC	●	—
		(3)	NO	—	●
		(4)	NC	●	—
With	2NO+2NC *1	(1)	NC	●	—
		(2)	NC	●	—
		(3)	NO	—	●
		(4)	NO	—	●

Notes: \*1 : AR30PL-2

● : Contact closed, — : Contact open

## 3-position

Transformer	Contact arrangement	Contact block		Operator position		
		Mounting position	Type	Left	Center	Right
				⊖	⊕	⊗
Without	1NO+1NC *1	(1)	NO	●	—	—
		(2)	NC	—	—	●
		1NO+1NC *2	(1)	NO	—	—
		(2)	NC	●	—	—
With	2NO+2NC *3	(1)	NO	●	—	—
		(2)	NC	—	—	●
		(3)	NO	●	—	—
		(4)	NC	—	—	●
With	1NO+1NC *1	(1)	NC	—	—	●
		(2)	NO	●	—	—
	1NO+1NC *2	(1)	NC	●	—	—
		(2)	NO	—	—	●
With	2NO+2NC *3	(1)	NC	—	—	●
		(2)	NC	—	—	●
		(3)	NO	●	—	—
		(4)	NO	●	—	—

Notes: \*1 : AR30PL-3, 6 \*3 : AR30PL-3

\*2 : AR30PL-7

● : Contact closed, — : Contact open

## ● Position of contact block

Without transformer

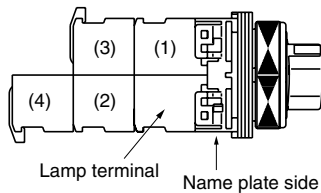



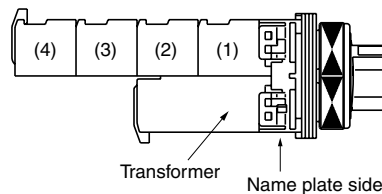



With transformer







■ Pilot lights/standard

Lens	Transformer	LED lamp		Incandescent lamp	
		Lamp voltage	Type	Lamp voltage	Type
 <p>AF95-18</p>	Without	6V AC 6V DC 12V AC/DC 24V AC/DC	DR30D0L-A3□ DR30D0L-63□ DR30D0L-B3□ DR30D0L-E3□	5.5V AC/DC — 15V AC/DC 24V AC/DC	DR30D0L-54□ — DR30D0L-C4□ DR30D0L-E4□
	With	100–110V AC 200–220V AC	DR30D0L-H3□ DR30D0L-M3□	100–110V AC 200–220V AC	DR30D0L-H4□ DR30D0L-M4□
 <p>AF97-674</p>	With resistor	50V DC 110V DC 220V DC	DR30D0L-FR□ DR30D0L-HR□ DR30D0L-MR□	50V DC — —	DR30D0L-FQ□ — —
	With resistor	— —	— —	110V DC 220V DC	DR30D0L-HQ□ DR30D0L-MQ□
 <p>AF95-20</p>	Without	6V AC 6V DC 12V AC/DC 24V AC/DC	DR30E3L-A3□ DR30E3L-63□ DR30E3L-B3□ DR30E3L-E3□	5.5V AC/DC — 15V AC/DC 24V AC/DC	DR30E3L-54□ — DR30E3L-C4□ DR30E3L-E4□
	With	100–110V AC 200–220V AC	DR30E3L-H3□ DR30E3L-M3□	100–110V AC 200–220V AC	DR30E3L-H4□ DR30E3L-M4□
 <p>AF95-19</p>	Without	6V AC 6V DC 12V AC/DC 24V AC/DC	DR30K0L-A3□ DR30K0L-63□ DR30K0L-B3□ DR30K0L-E3□	5.5V AC/DC — 15V AC/DC 24V AC/DC	DR30K0L-54□ — DR30K0L-C4□ DR30K0L-E4□
	With	100–110V AC 200–220V AC	DR30K0L-H3□ DR30K0L-M3□	100–110V AC 200–220V AC	DR30K0L-H4□ DR30K0L-M4□
 <p>AF97-673</p>	With resistor	50V DC 110V DC 220V DC	DR30K0L-FR□ DR30K0L-HR□ DR30K0L-MR□	50V DC — —	DR30K0L-FQ□ — —
	With resistor	— —	— —	110V DC 220V DC	DR30K0L-HQ□ DR30K0L-MQ□
 <p>AF97-671</p>	With resistor	— —	— —	110V DC 220V DC	DR30K0L-HQ□ DR30K0L-MQ□
	Without	6V AC 6V DC 12V AC/DC 15V AC/DC 24V AC/DC	DR30D1L-A3□ DR30D1L-63□ DR30D1L-B3□ DR30D1L-C3□ DR30D1L-E3□	5.5V AC/DC — — 15V AC/DC 24V AC/DC	DR30D1L-54□ — — DR30D1L-C4□ DR30D1L-E4□
 <p>KK02-144A</p>	With	100V–110V AC 200V–220V AC	DR30D1L-H3□ DR30D1L-M3□	100V–110V AC 200V–220V AC	DR30D1L-H4□ DR30D1L-M4□

Note: □ See page 88

# Pilot Lights DR30

## ■ Pilot lights/short-body with transformer

Lens	LED lamp		Incandescent lamp	
	Lamp voltage	Type	Lamp voltage	Type
Dome  <small>KK02-141A</small>	100–110V AC 200–220V AC 115–127V AC	<b>DR30D0L-H9</b> □ <b>DR30D0L-M9</b> □ <b>DR30D0L-L9</b> □	100–110V AC 200–220V AC 115–127V AC	<b>DR30D0L-H8</b> □ <b>DR30D0L-M8</b> □ <b>DR30D0L-L8</b> □
Extended round  <small>KK02-142A</small>	100–110V AC 200–220V AC 115–127V AC	<b>DR30E3L-H9</b> □ <b>DR30E3L-M9</b> □ <b>DR30E0L-L9</b> □	100–110V AC 200–220V AC 115–127V AC	<b>DR30E3L-H8</b> □ <b>DR30E3L-M8</b> □ <b>DR30E0L-L8</b> □
Faceted  <small>KK02-143A</small>	100–110V AC 200–220V AC 115–127V AC	<b>DR30K0L-H9</b> □ <b>DR30K0L-M9</b> □ <b>DR30K0L-L9</b> □	100–110V AC 200–220V AC 115–127V AC	<b>DR30K0L-H8</b> □ <b>DR30K0L-M8</b> □ <b>DR30K0L-L8</b> □

### • Lens color

Replace the □ mark by the following lens color code



Color	Green	Red	White	Blue	Yellow	Orange
Code	G	R	W	S	Y	A

### • Lamp voltage

Available lamp voltage are as follow.

Description	Voltage	Code		Code	
		Standard type		Short-body type	
		LED	Incandescent	LED	Incandescent
Without transformer	5.5V AC/DC	–	54	–	–
	6V AC	A3	–	–	–
	6V DC	63	–	–	–
	12V AC/DC	B3	–	–	–
	15V AC/DC	C3	C4	–	–
	20V AC/DC	–	D4	–	–
	24V AC/DC	E3	E4	–	–
	With transformer	100-110V AC	H3	H4	H9
115-127V AC		L3	L4	L9	L8
200-220V AC		M3	M4	M9	M8
230-254V AC		Q3	Q4	–	–
350-380V AC		S3	S4	–	–
400-440V AC		T3	T4	–	–
480V AC		V3	V4	–	–
500-550V AC		W3	W4	–	–
With resistor unit	110V DC	H7	–	–	–
With resistor	50V DC	FR	FQ	–	–
	110V DC	HR	HQ	–	–
	220V DC	MR	MQ	–	–

■ Pilot lights/standard

Lens	Transformer	LED unit		Incandescent lamp	
		Lamp voltage	Type	Lamp voltage	Type
Flush square (34mm sq. transparent lens) 	Without	6V DC 15V AC/DC 24V AC/DC	DR30F4M-65□ DR30F4M-C5□ DR30F4M-E5□	5.5V AC/DC 15V AC/DC 24V AC/DC	DR30F4M-54□ DR30F4M-C4□ DR30F4M-E4□
	With	100–110V AC 200–220V AC	DR30F4M-H5□ DR30F4M-M5□	100–110V AC 200–220V AC	DR30F4M-H4□ DR30F4M-M4□
Flush rectangular (Transparent lens) 	Without	6V DC 15V AC/DC 24V AC/DC	DR30F4N-65□ DR30F4N-C5□ DR30F4N-E5□	5.5V AC/DC 15V AC/DC 24V AC/DC	DR30F4N-54□ DR30F4N-C4□ DR30F4N-E4□
	With	100–110V AC 200–220V AC	DR30F4N-H5□ DR30F4N-M5□	100–110V AC 200–220V AC	DR30F4N-H4□ DR30F4N-M4□
Flush square (40mm sq. transparent lens) 	Without	6V DC 15V AC/DC 24V AC/DC	DR30M4M-65□ DR30M4M-C5□ DR30M4M-E5□	5.5V AC/DC 15V AC/DC 24V AC/DC	DR30M4M-54□ DR30M4M-C4□ DR30M4M-E4□
	With	100–110V AC 200–220V AC	DR30M4M-H5□ DR30M4M-M5□	100–110V AC 200–220V AC	DR30M4M-H4□ DR30M4M-M4□

• Color plate

Replace the □ mark by the following color plate color code

Color	Green	Red	White	Blue*	Yellow	Orange
Code	G	R	W	S	Y	A

Note: \* Incandescent lamp only















• Lamp voltage

Available lamp voltage are as follow.

Description	Voltage	Code	
		Standard type	
		LED	Incandescent
Without transformer	5.5V AC/DC	–	54
	6V AC	A5	–
	6V DC	65	–
	12V AC	25	–
	12V AC/DC	B5	–
	15V AC/DC	C5	C4
	20V AC/DC	–	D4
	24V AC/DC	E5	E4
With transformer	100-110V AC	H5	H4
	115-127V AC	L5	L4
	200-220V AC	M5	M4
	230-254V AC	Q5	Q4
	350-380V AC	S5	S4
	400-440V AC	T5	T4
	480V AC	V5	V4
	500-550V AC	W5	W4
With resistor unit	110V DC	HE	–

# Joy Stick Selector Switches AR30

## ■ Joy stick selector switches

Handle	Terminal	Operating directions	Contact arrangement	Type	
				Manual return	Spring return
 <small>AF97-48</small>	Screw		1NO × 2	<b>AR30A0N-A0A0B</b>	<b>AR30A5N-A0A0B</b>
			1NO + 1NC × 2	<b>AR30A0N-1010B</b>	<b>AR30A5N-1010B</b>
	Solder/tab		1NO × 4	<b>AR30A0N-AAAAB</b>	<b>AR30A5N-AAAAB</b>
			1NO + 1NC × 4	<b>AR30A0N-1111B</b>	<b>AR30A5N-1111B</b>
	Solder/tab		1NO + 1NC × 2	<b>AR30A0H-1010B</b>	<b>AR30A5H-1010B</b>
			2NO + 2NC × 2	<b>AR30A0H-2020B</b>	<b>AR30A5H-2020B</b>
Solder/tab		1NO + 1NC × 4	<b>AR30A0H-1111B</b>	<b>AR30A5H-1111B</b>	
		2NO + 2NC × 4	<b>AR30A0H-2222B</b>	<b>AR30A5H-2222B</b>	
 <small>AF97-44</small>	Screw		1NO × 2	<b>AR30A1N-A0A0B</b>	<b>AR30A6N-A0A0B</b>
			1NO + 1NC × 2	<b>AR30A1N-1010B</b>	<b>AR30A6N-1010B</b>
	Solder/tab		1NO × 4	<b>AR30A1N-AAAAB</b>	<b>AR30A6N-AAAAB</b>
			1NO + 1NC × 4	<b>AR30A1N-1111B</b>	<b>AR30A6N-1111B</b>
	Solder/tab		1NO + 1NC × 2	<b>AR30A1H-1010B</b>	<b>AR30A6H-1010B</b>
			2NO + 2NC × 2	<b>AR30A1H-2020B</b>	<b>AR30A6H-2020B</b>
Solder/tab		1NO + 1NC × 4	<b>AR30A1H-1111B</b>	<b>AR30A6H-1111B</b>	
		2NO + 2NC × 4	<b>AR30A1H-2222B</b>	<b>AR30A6H-2222B</b>	
 <small>AF97-57</small>	Screw		1NO × 2	<b>AR30A2N-A0A0B</b>	<b>AR30A7N-A0A0B</b>
			1NO + 1NC × 2	<b>AR30A2N-1010B</b>	<b>AR30A7N-1010B</b>
	Solder/tab		1NO × 4	<b>AR30A2N-AAAAB</b>	<b>AR30A7N-AAAAB</b>
			1NO + 1NC × 4	<b>AR30A2N-1111B</b>	<b>AR30A7N-1111B</b>
	Solder/tab		1NO + 1NC × 2	<b>AR30A2H-1010B</b>	<b>AR30A7H-1010B</b>
			2NO + 2NC × 2	<b>AR30A2H-2020B</b>	<b>AR30A7H-2020B</b>
Solder/tab		1NO + 1NC × 4	<b>AR30A2H-1111B</b>	<b>AR30A7H-1111B</b>	
		2NO + 2NC × 4	<b>AR30A2H-2222B</b>	<b>AR30A7H-2222B</b>	

### • Operating direction

- Directions other than those shown in the table above can be provided.
- For types AR30A□N-**1****2****3****4** B, designate the contact arrangement codes for the necessary operating directions (**1**: Upper,**2**: Right, **3**: Lower,**4**: Left). Designate "0" for unnecessary directions.

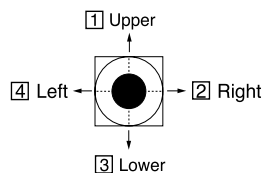



### • Contact arrangement

Contact arrangement		-	1NO	1NC	1NO+1NC	2NO	2NC	2NO+2NC
Manual return	Screw	0	A	B	1	D	E	-
Spring return	Solder/Tab	0	-	-	1	-	-	2

- Spring/manual return are also available, contact FUJI .

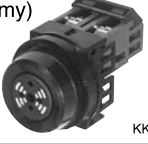
■ Buzzers

Sound	Description	Transformer	Operating voltage	Type
Electronic sound  AF96-381	<ul style="list-style-type: none"> <li>• LED operation indicator (Red)</li> <li>• Intermittent/continuous sound selection</li> <li>• Sound level: 90dB (0.1m) 70dB (1m)</li> </ul>	Without	6V AC 6V DC 12 to 24V AC/DC 35 to 48V AC/DC	<b>DR30B5-AB</b> <b>DR30B5-6B</b> <b>DR30B5-EB</b> <b>DR30B5-FB</b>
		With	100 to 110V AC 200 to 220V AC	<b>DR30B5-HB</b> <b>DR30B5-MB</b>
		With resistor unit	100 to 110V DC	<b>DR30B5-1B</b>
Electronic sound (economy)  KK02-145A	<ul style="list-style-type: none"> <li>• Sound level: 90dB (0.1m) 70dB (1m)</li> </ul>	Without	6V DC 24V AC 24V DC	<b>DR30B6-6B</b> <b>DR30B6-GB</b> <b>DR30B6-EB</b>
		With	100 to 110V AC 200 to 220V AC	<b>DR30B6-HB</b> <b>DR30B6-MB</b>
Magnetic sound  AF96-378	<ul style="list-style-type: none"> <li>• Sound level: 90dB (0.1m) 70dB (1m)</li> </ul>	Without	100 to 110V AC 200 to 220V AC	<b>DR30B0-HB</b> <b>DR30B0-MB</b>
Electronic sound (IP54)  AF96-245	<ul style="list-style-type: none"> <li>• Intermittent/continuous sound selection</li> <li>• Sound level: 80dB (0.1m) 60dB (1m)</li> </ul>	Without	6V AC 6V DC 12 to 24V AC/DC 35 to 48V AC/DC	<b>DR30B8-AB</b> <b>DR30B8-6B</b> <b>DR30B8-EB</b> <b>DR30B8-FB</b>
		With	100 to 110V AC 200 to 220V AC	<b>DR30B8-HB</b> <b>DR30B8-MB</b>
		With resistor unit	100 to 110V DC	<b>DR30B8-1B</b>

Notes: • Intermittent/continuous sound selection (DR30B5, B8)  
 See the "Short-circuit terminal" in the dimensions diagram on the 102. page, and select as follows:  
 • Short-circuit terminal mounted → Intermittent sound  
 • Short-circuit terminal not mounted → Continuous sound

# Pushbuttons/Selectors/Pilot Lights/Buzzers

## AR30 and DR30

### Dimensions

#### ■ Dimensions, mm

#### ● Illuminated pushbuttons

#### Extended

With transformer

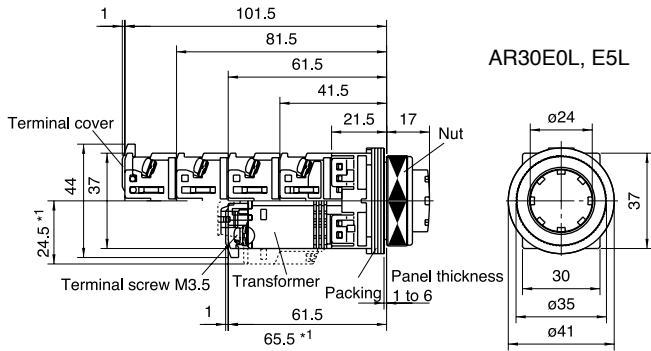

Without transformer

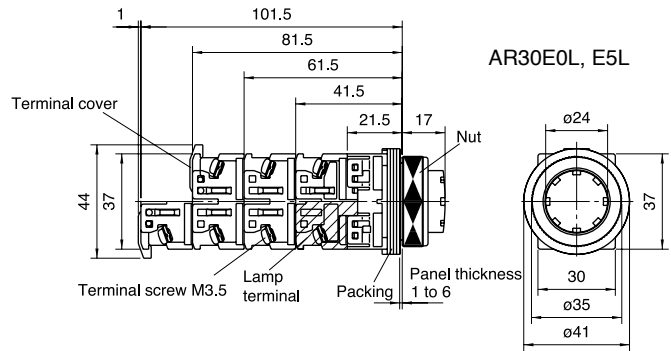

Extended with transparent full guard (24mm dia.)

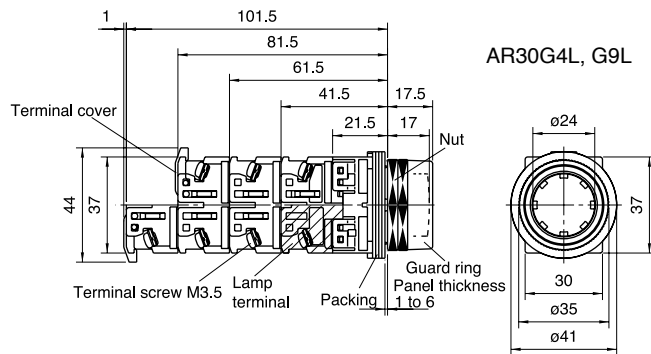

Extended with full guard (24mm dia. with openings)

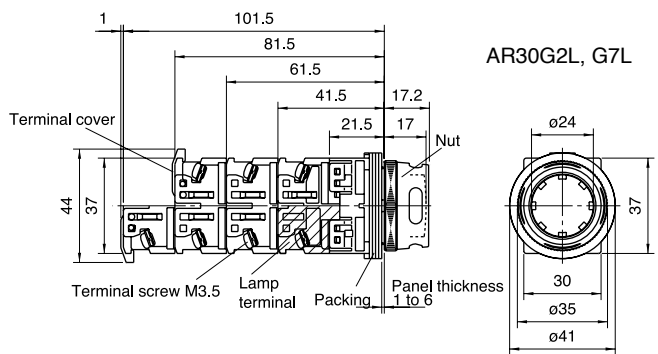

Extended with full guard (24mm dia.)

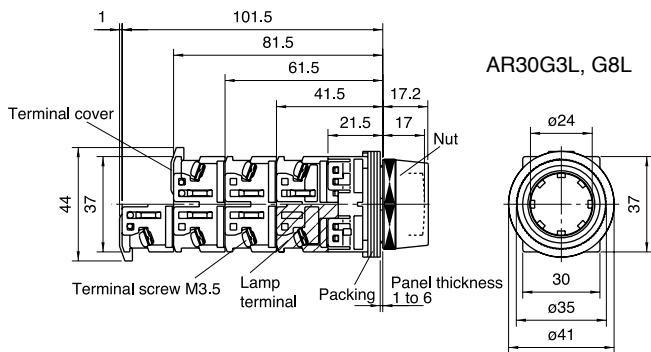

Note: \*1 Except for the types 110V AC, 127V AC and 220V AC.

# Pushbuttons/Selectors/Pilot Lights/Buzzers AR30 and DR30 Dimensions

## ■ Dimensions, mm

### ● Illuminated pushbuttons

**Push-lock, turn-reset (40mm dia. with white arrow)**

With transformer

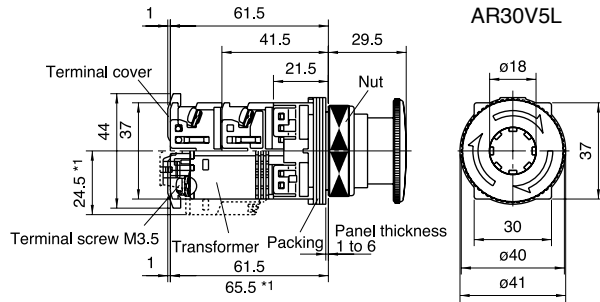

Without transformer

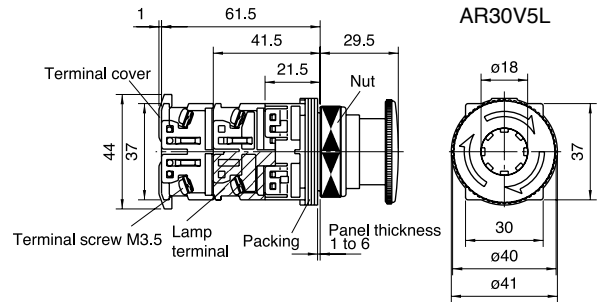

### Push-pull

With transformer

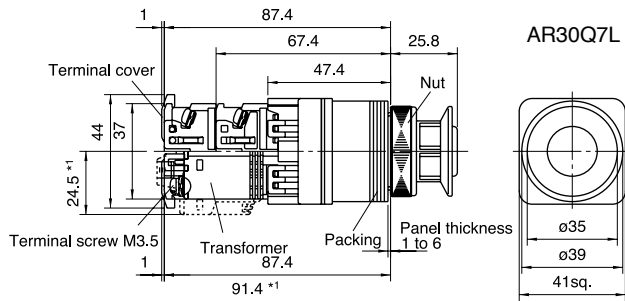

Without transformer

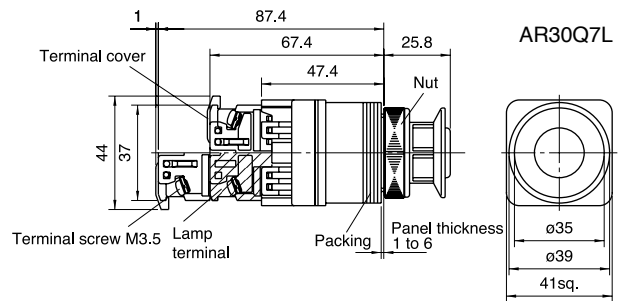

Note: \*1 Except for the types 110V AC, 127V AC and 220V AC.

# Pushbuttons/Selectors/Pilot Lights/Buzzers

## AR30 and DR30

### Dimensions

#### ■ Dimensions, mm

#### ● Pushbuttons

#### Flush/Extended

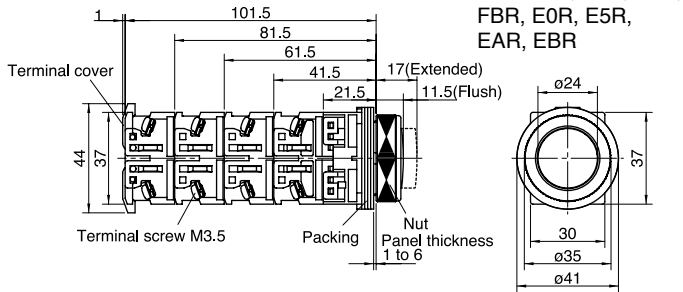

#### Mushroom (40mm dia.)

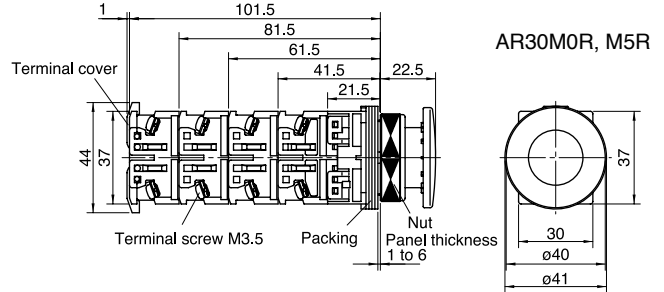

#### Mushroom (29mm dia.)

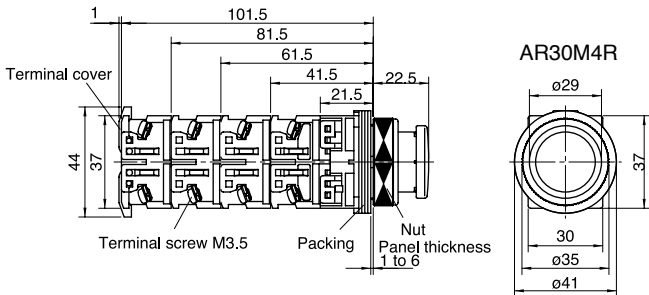

#### Extended with full guard (24mm dia.)

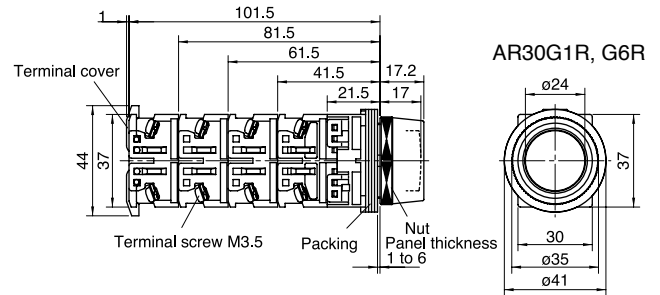

#### Extended with half guard

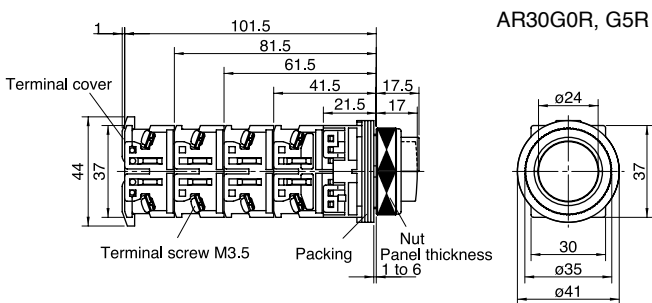

#### Pin lock

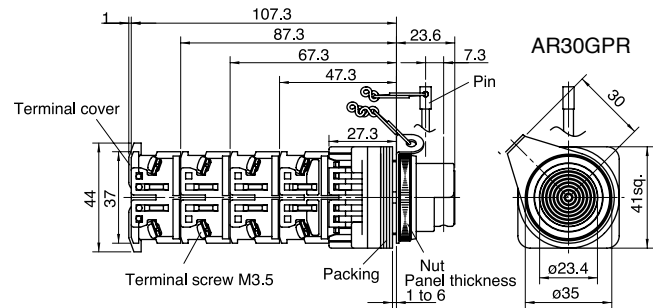

#### Mushroom with full guard (40mm dia.)

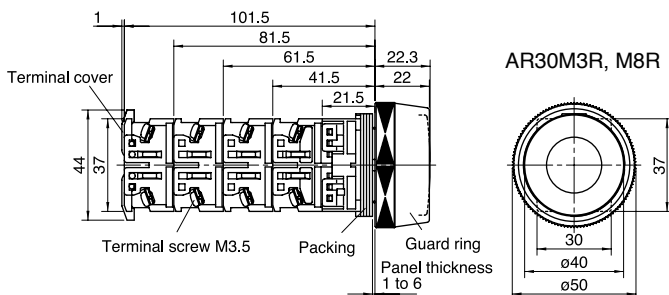

#### Mushroom with full guard (35mm dia. metal nut)

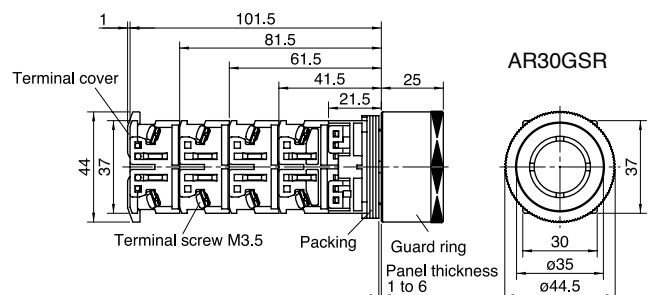



# Pushbuttons/Selectors/Pilot Lights/Buzzers AR30 and DR30 Dimensions

## ■ Dimensions, mm

### ● Pushbuttons

#### Giant

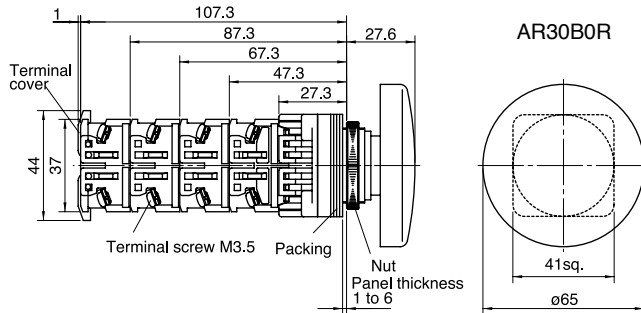

#### Giant with guard

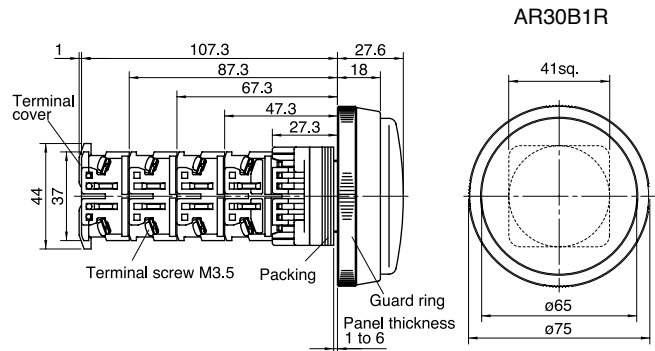

#### Giant with full guard

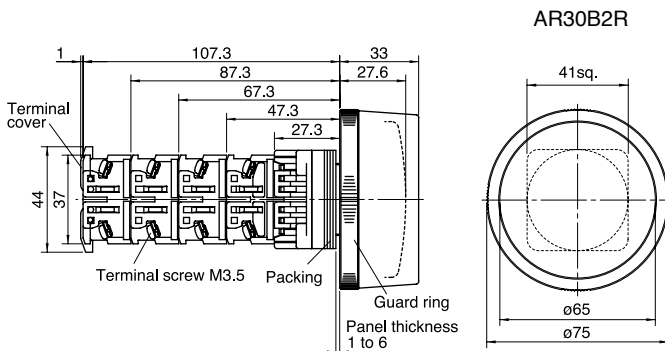

#### Giant with full guard

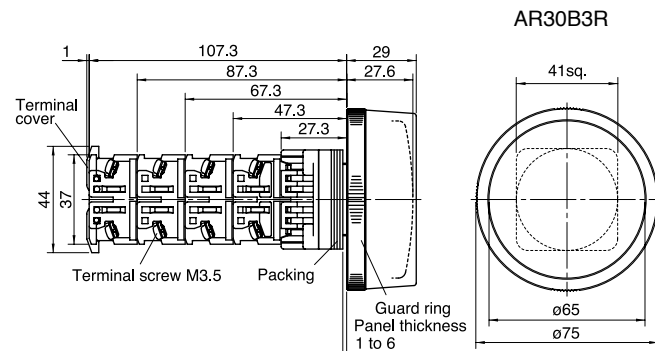

#### Pushbutton with selector ring (2-position)

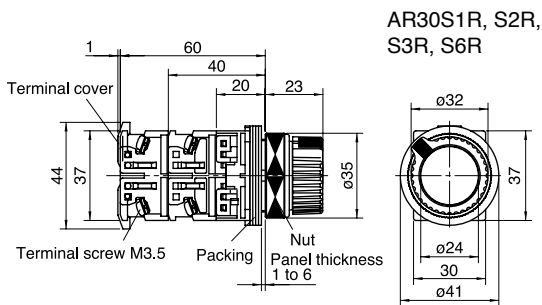

#### Push, turn-lock

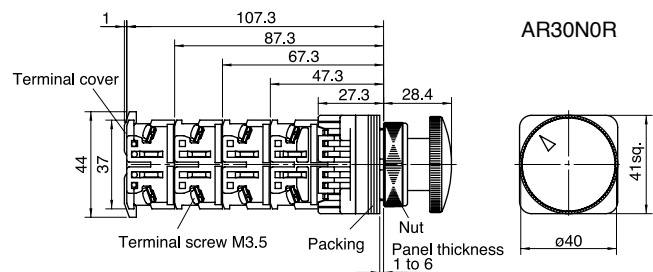

Note:  
When the push button is pressed in the left position, it resets automatically (momentary operation).  
When pressed and turned to the right it locks, and to the left it resets.

#### Push-lock, turn-reset (40mm dia. with white arrow)

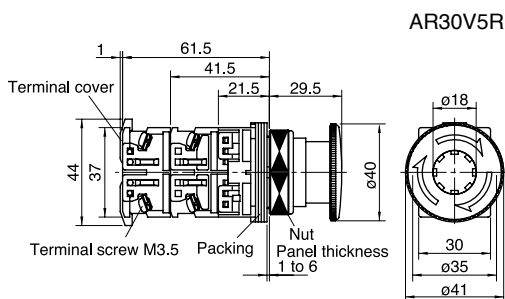

#### Emergency operating cap

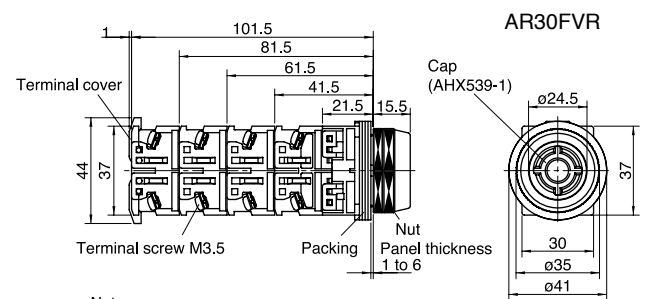

Note:  
This is pushbutton switch is operated while holding the cap with the fingertips. The cap (AHX539-1) can be exchanged.

# Pushbuttons/Selectors/Pilot Lights/Buzzers

## AR30 and DR30

### Dimensions

#### ■ Dimensions, mm

#### ● Emergency stop pushbuttons

#### Push-lock, turn-reset (40mm dia.)

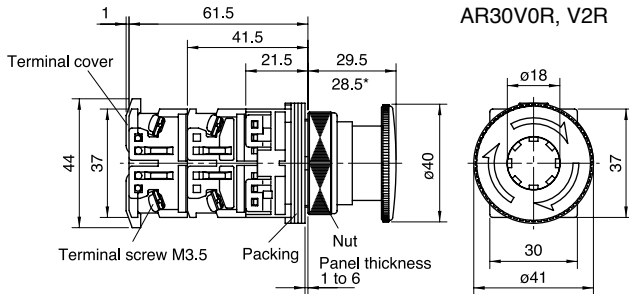

Note: \* AR30V2R type

#### Push-lock, turn-reset (65mm dia. with white allow)

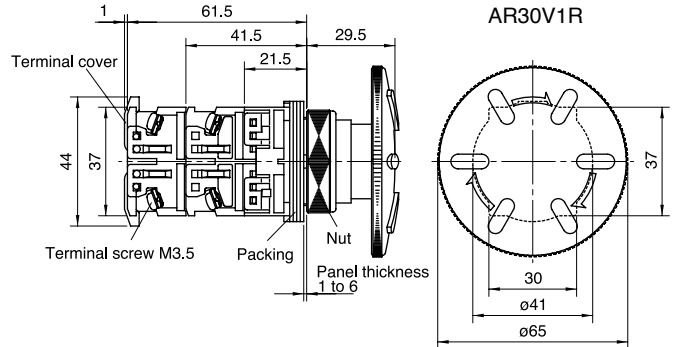

#### Push-lock, pull-reset (35mm dia.)

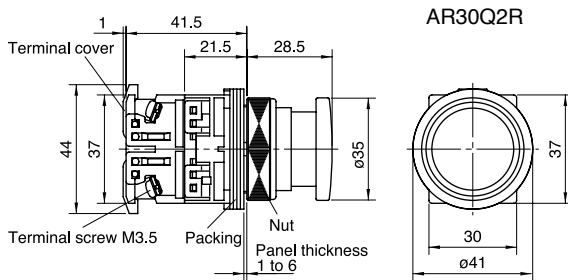

#### ● Emergency stop illuminated pushbuttons

#### Push-lock, turn-reset (40mm dia.)

#### With transformer

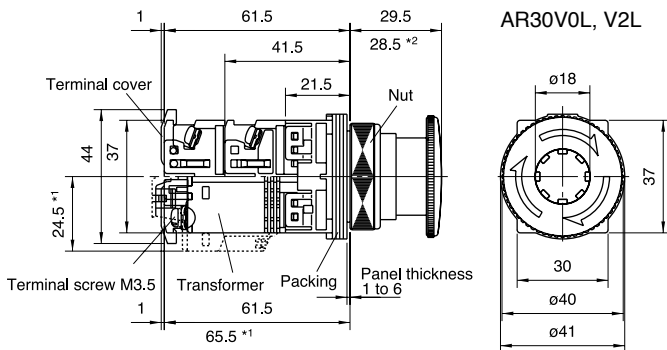

#### Without transformer

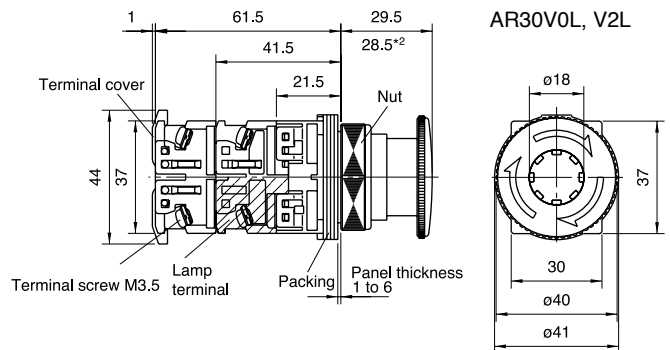

Notes: \*1 Except for the types 110V AC, 127V AC and 220V AC.

\*2 AR30V2L type

# Pushbuttons/Selectors/Pilot Lights/Buzzers AR30 and DR30 Dimensions

## ■ Dimensions, mm

### ● Selector switches

#### Knob

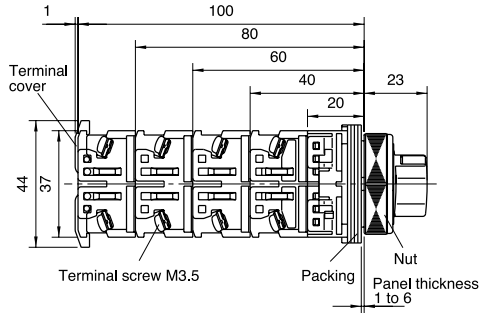

AR30PR, PCR

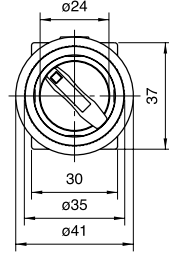

#### Lever

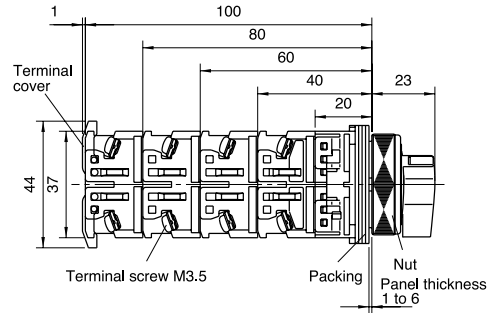

AR30WR, WCR

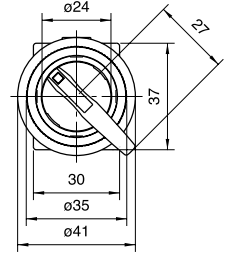

#### Key

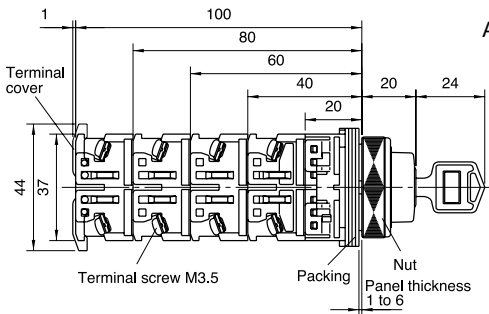

AR30JR, JCR, JAR

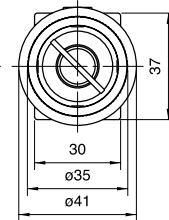

### ● Illuminated selector switches

#### Knob

##### With transformer

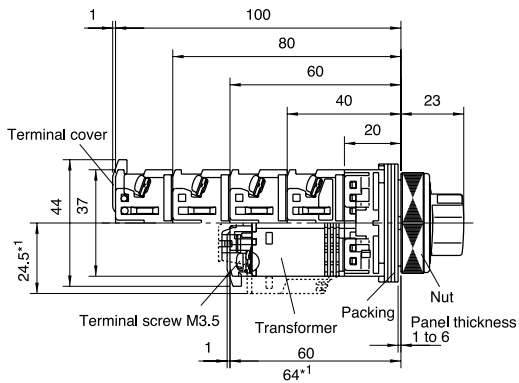

AR30PL

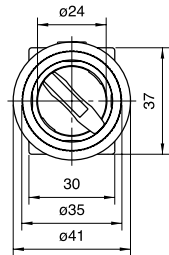

##### Without transformer

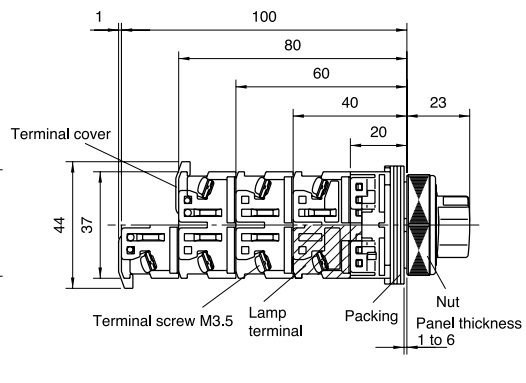

AR30PL

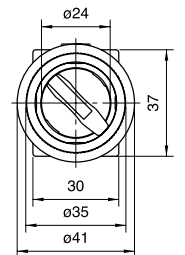

Notes: \*1 Except for the types 110V AC, 127V AC and 220V AC.

# Pushbuttons/Selectors/Pilot Lights/Buzzers

## AR30 and DR30

### Dimensions

#### ■ Dimensions, mm

#### ● Pilot lights

#### Dome

With transformer, with resistor unit

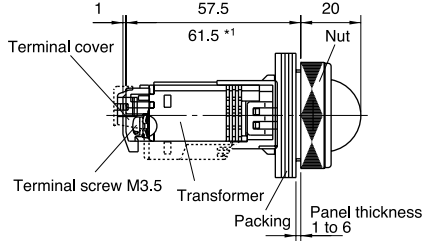

Without transformer

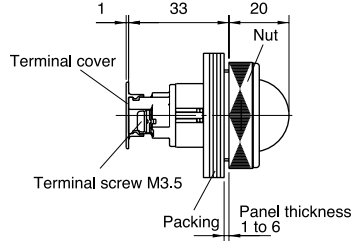

DR30D0L

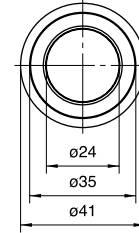

With resistor LED, incandescent (50V DC)

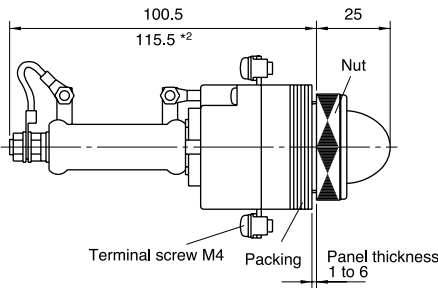

With resistor Incandescent (110, 220V DC)

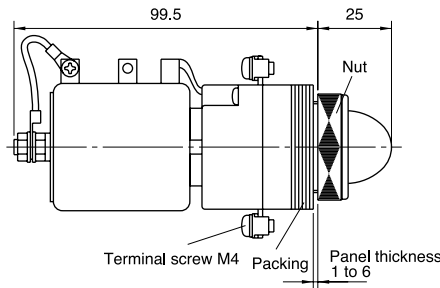

DR30D0L

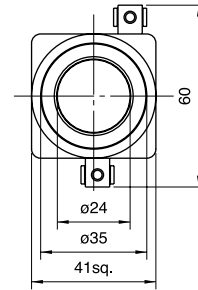

Short-body / with transformer

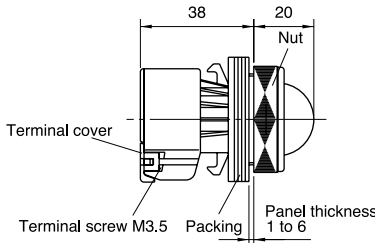

DR30D0L

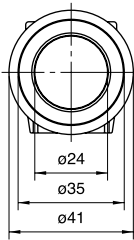

#### Extended

With transformer, with resistor unit

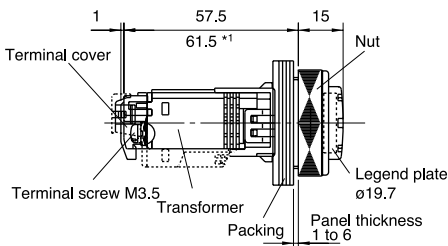

Without transformer

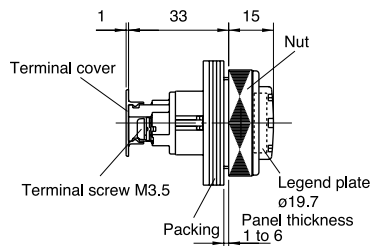

DR30E3L

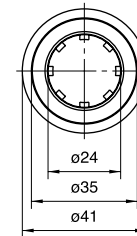

Short-body / with transformer

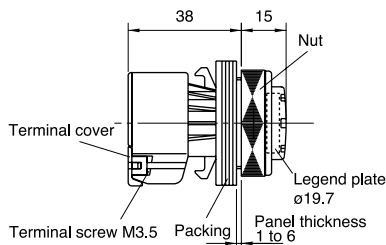

DR30E3L

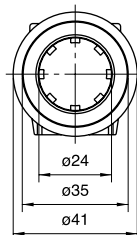

Notes: \*1 Except for the types 110V AC, 127V AC and 220V AC.  
\*2 Incandescent (50V DC) type only

# Pushbuttons/Selectors/Pilot Lights/Buzzers AR30 and DR30 Dimensions

## ■ Dimensions, mm

### ● Pilot lights

#### Faceted

With transformer, with resistor unit

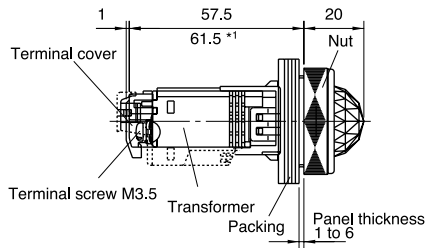

Without transformer

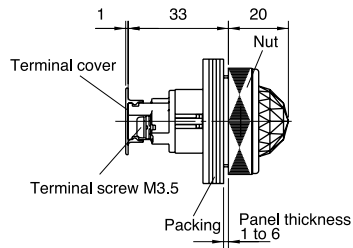

DR30K0L

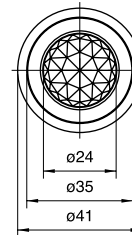

With resistor LED, incandescent (50V DC)

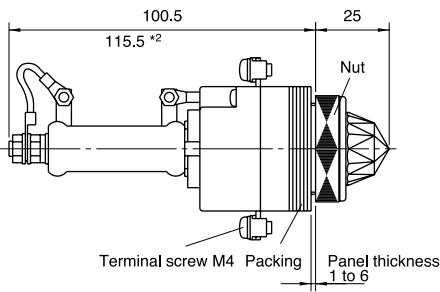

With resistor LED, incandescent (110, 220V DC)

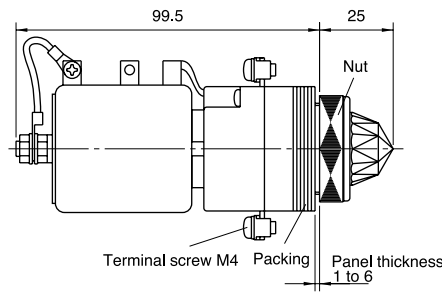

DR30K0L

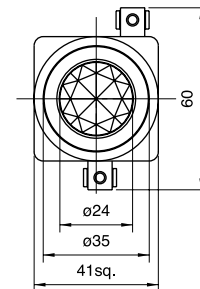

Short-body / with transformer

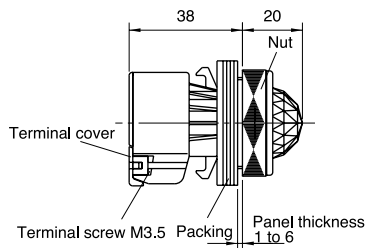

DR30K0L

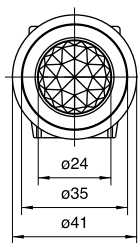

Dome with dimmer control

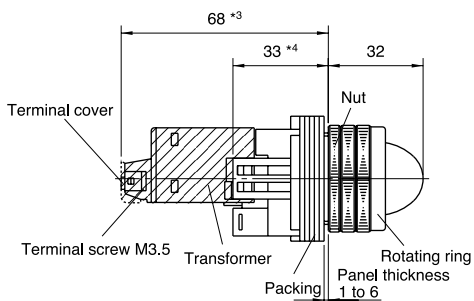

DR30D1L

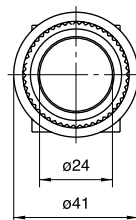

Notes: \*1 Except for the types 110V AC, 127V AC and 220V AC.

\*2 Incandescent (50V DC) type only

\*3 With transformer, with resistor unit type only

\*4 For without transformer types, add 1 mm when mounting the terminal cover.

# Pushbuttons/Selectors/Pilot Lights/Buzzers

## AR30 and DR30

### Dimensions

#### ■ Dimensions, mm

#### ● Pilot lights

#### Flush square (34mm sq. transparent lens)

With transformer, with resistor unit

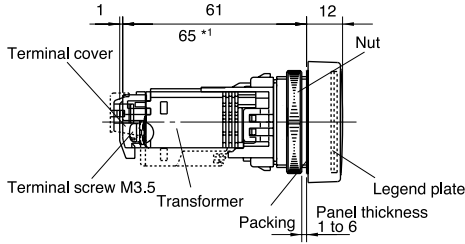

Without transformer

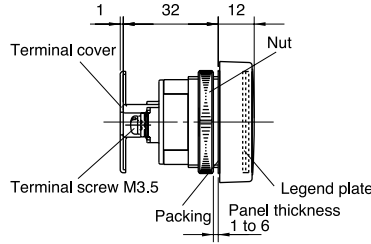

DR30F4M

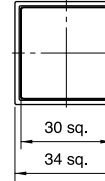

#### Flush rectangular (Transparent lens)

With transformer, with resistor unit

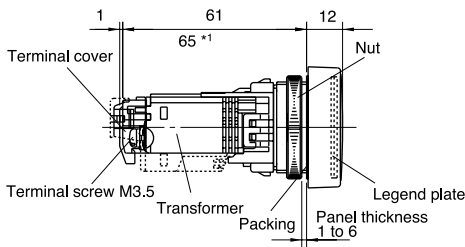

Without transformer

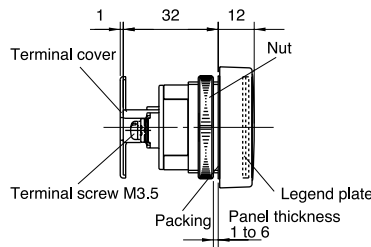

DR30F4N

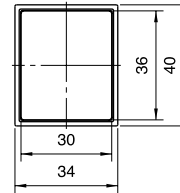

#### Flush square (40mm sq. transparent lens)

With transformer, with resistor unit

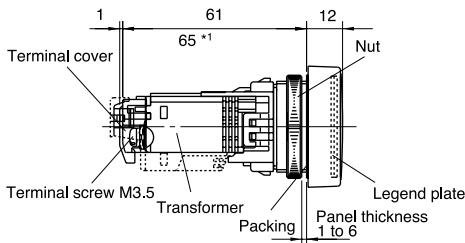

Without transformer

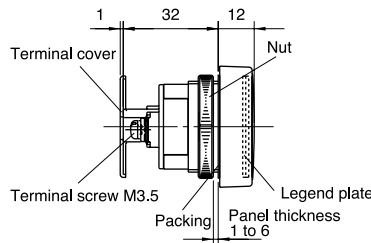

DR30M4M

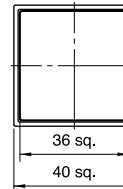

Note: \*1 Except for the types 110V AC, 127V AC and 220V AC.

# Pushbuttons/Selectors/Pilot Lights/Buzzers AR30 and DR30 Dimensions

## ■ Dimensions, mm

### ● Joy stick selector switches

#### Ball type (without lock)

AR30A0N, A5N: Screw terminal

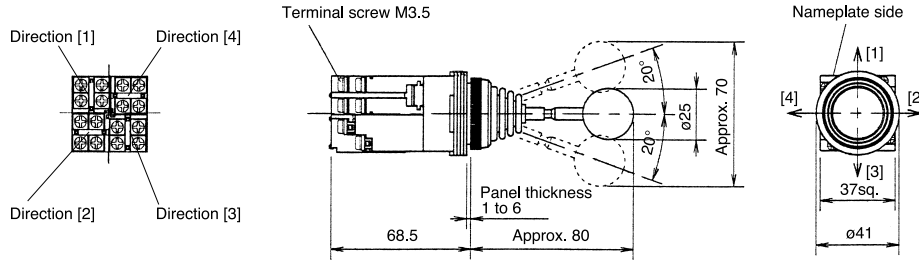

#### Ball type with lock

AR30A1N, A6N: Screw terminal

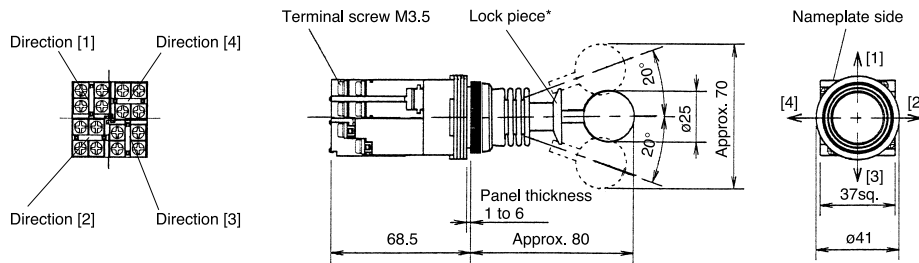

Notes \* The contact arrangement is operable in the designated direction by pulling the lock piece in the central position with the fingers. The lock piece will return automatically and locks when the lock piece is released in the central position. The lock piece locks in the central position only.

#### Rubber cap type (without lock)

AR30A2N, A7N: Screw terminal

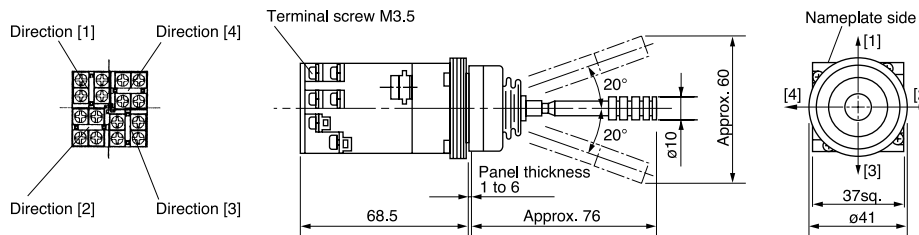

#### Solder/tab terminal: AR30A□H

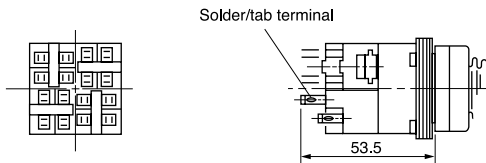

# Pushbuttons/Selectors/Pilot Lights/Buzzers

## AR30 and DR30

### Dimensions

#### ■ Dimensions, mm

#### ● Buzzers

#### Electronic sound

With transformer

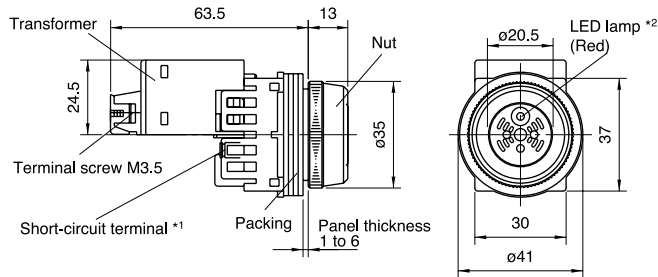

Without transformer

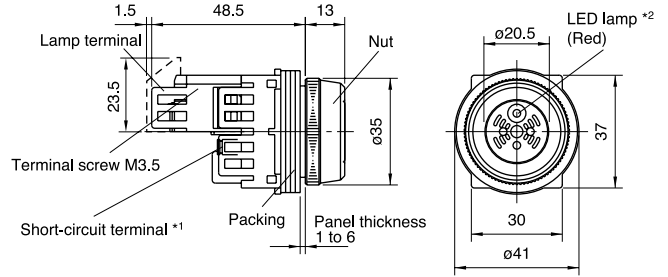

#### Magnetic sound

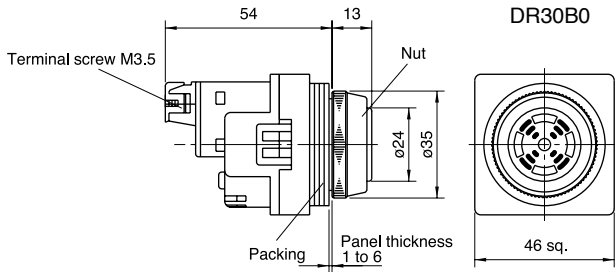

#### Electronic sound (IP54)

With transformer

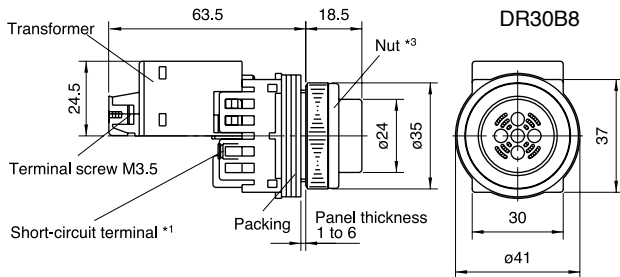

Without transformer

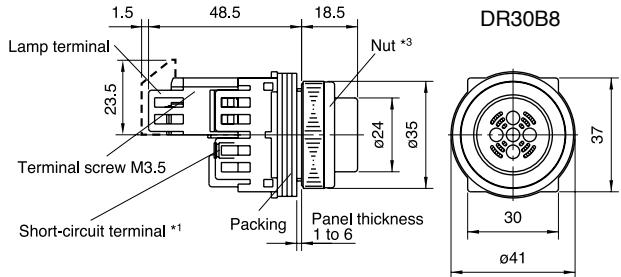

Notes: \*1 There are no short-circuit terminals with DR30B6. (Continuous sound only)

\*2 There are no LED lamps with DR30B6.

\*3 The nut and cap are united with DR30B8.



# Pushbuttons/Selectors/Pilot Lights AR30 and DR30 Notes on use

## Notes on use

### ■ Panel cutout hole

Fig. 1 Panel cutout hole dimensions, mm

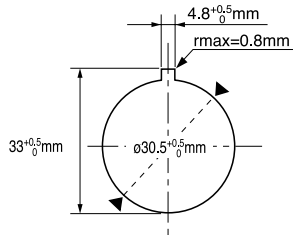

Note : If key-washer or legend plate are not used, 4.8mm-wide, location holes shown in Fig. 1 need not be cutout.

### ■ Mounting operator to panel

#### 1. Pushbutton with a round bezel (ordinary mounting)

Insert the operator into the cutout hole from the back of the panel, and tighten the nut with the AHX001 wrench from the front of the panel to secure the operator as shown in Fig.2.

Fig. 2 Pushbutton with a round bezel

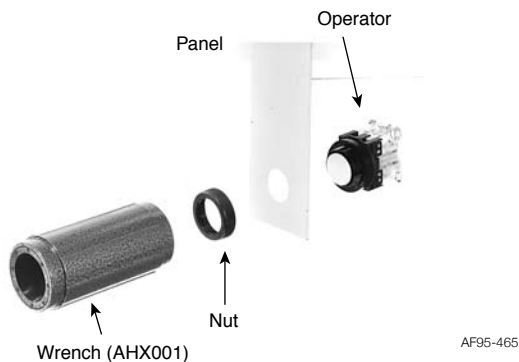

Note : Recommended tightening torque is from 1.5 to 2N·m.

#### 2. AR30V0R, V0L, V2R, V2L, V5R, V5L

- (1) The button is removed after loosening the center button by inserting the end of the AR9A002 tightening wrench or the AR9A005 wrench (enclosed with pushbutton) into the holes in the center button and turning counterclockwise, as shown in Fig.3.
- (2) Attach the operator in the same manner as described in step 1.

Fig. 3

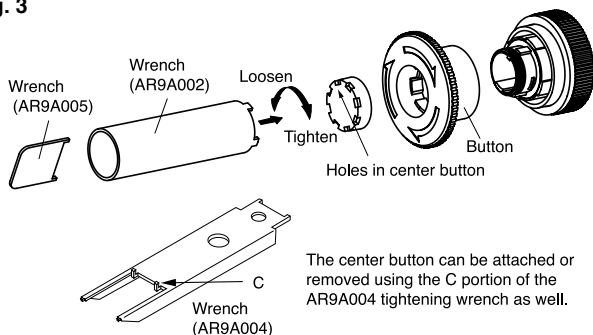

Insert the operator into the cutout hole from the back of the panel, and as shown in Fig.4, insert the pushbutton into the operator cylinder while aligning the grooves inside the pushbutton with the protrusions on the operator.

Fig. 4 Setting pushbutton to operator cylinder

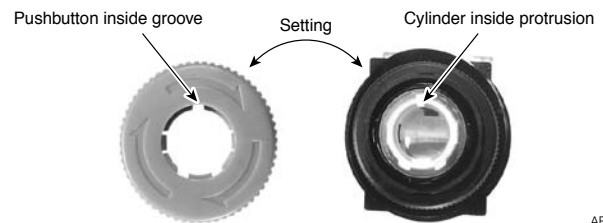

### 3. AR30WR, WCR

- (1) As shown in the following figure, insert the tip of a flathead screwdriver into the selector tip groove. Rotate the screwdriver in the direction indicated by the arrow until the selector tip rises, and draw out the knob.
- (2) Attach the operator in the same manner as described in step 1.
- (3) Insert the knob, with the selector tip in the floated state, into the original position of the rotation tube, and push the selector tip into place.

Fig. 5

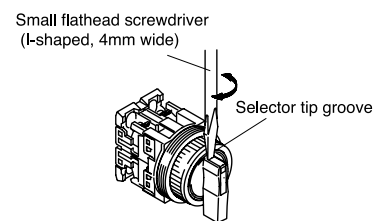

### 4. AR30M0R, M4R, M5R, B0R, Q7L

- (1) Loosen the button by hand.
- (2) Attach the operator in the same manner as described in step 1.
- (3) Screw in the button by hand, making sure that the button is screwed in all the way. (Recommended tightening torque: 0.3 to 0.5 N·m)

Fig. 6

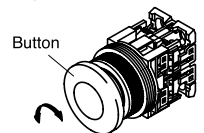

### 5. AR30M3R, M8R, B1R, B2R and B3R

The outer circumference of the nut is threaded, so be careful not to cut your hand on it.

- (1) Loosen and remove the guard ring by hand.
- (2) Loosen and remove the button and nut by hand.
- (3) Insert the operator into the cutout hole from the back of the panel, and tighten the nut to secure it in place. (Recommended tightening torque: 0.3 to 0.5 N·m)
- (4) Screw in the button by hand, making sure that it is screwed in all the way. (Recommended tightening torque: 0.3 to 0.5 N·m)
- (5) Loosen and remove the guard ring by hand. (Recommended tightening torque: 1.5 to 2.5 N·m)

Fig. 7

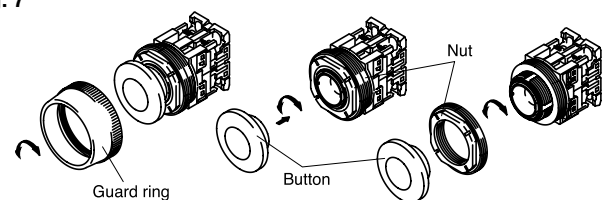

# Pushbuttons/Selectors/Pilot Lights

## AR30 and DR30

### Notes on use

#### 6. AR30N0R, V1R, Q2R

- (1) Loosen and remove the screw on the side of the button, taking care not to loosen the screw.
- (2) Attach the operator in the same manner as described in step 1.
- (3) Attach and secure the button in place with the screw, making sure that the head of the screw does not protrude from the side.
- (4) Recommended tightening torque: N0R 0.5 to 1.0N•m  
V1R 0.5 to 1.0N•m  
Q2R 0.3 to 0.5N•m

Fig. 8

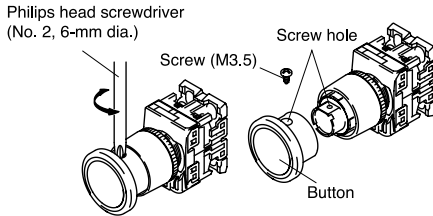

#### 7. AR30GSR

- (1) Insert the tips of the AR9A001 wrench into the indentations around the button center, and turn the wrench to loosen and remove the button.
- (2) Loosen and remove the guard ring by hand.
- (3) Insert the switch operator into the cutout hole from the back of the panel, and secure it with the guard ring from the front of the panel. (Recommended tightening torque: 1.5 to 2.5 N•m)
- (4) Attach and secure the button with the AR9A001 wrench. (Recommended tightening torque: 0.3 to 0.5 N•m)

Fig. 9

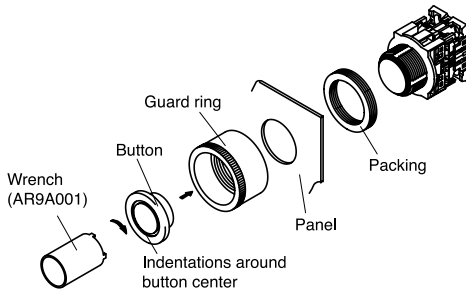

#### 8. DR30F4M, F4N, M4M

Insert the pilot lights from the front of the panel and fix it with the AHX536 tightening wrench from the back of the panel.

- (1) Recommended tightening torque: 1 to 1.5N•m
- (2) For pilot lights with transformers and resistance units, remove the transformer or resistance unit in advance. (Fig.10)

Fig. 10

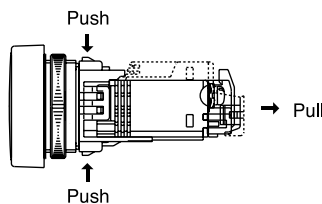

#### 9. Mounting a 22mm-dia. command switch with a square button and a square bezel, or with a round button and a square bezel, to a panel cutout hole for a 30mm-dia. command switch using an adapter

As shown in Fig. 11, mount an adapter and packing onto a 22mm-dia. command switch (AR22, DR22 series) with a square button and a square bezel or one with a round button and a square bezel. Then, insert the switch operator into the panel cutout hole from the front of the panel. Use AR9A004 wrench section A to tighten the locking nut from behind the panel to secure the switch.

Use the adapter accessory nut for this purpose. Do not use the command switch accessory nut.

#### Fig. 11 Command switch with a square button and a square bezel, and command switch with a round button and a square bezel

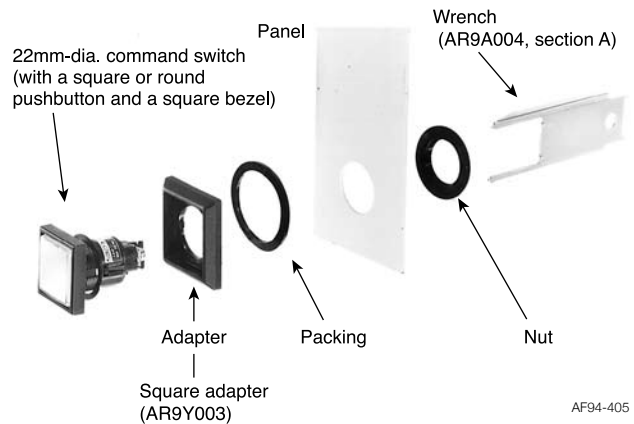

- Note : • Recommended tightening torque is from 1 to 1.5N•m.  
• Panel thickness: 2.5 to 5mm

This adapter can be used with the following 22mm-dia. Command switches :

- AR22F0M, F5M, E0M, E5M, F0P, F5P, E0P, E5P, M4P
- AR22F0S, F5S, E0S, E5S, F0Y, F5Y, E0Y, E5Y, M4Y
- AR22PY, PCY, WY, WCY, RY, RCY, JY, JCY, PP
- DR22F3M, F4M, F5M, E3M, E3P

#### 10. AR30S1R, S2R, S3R, S6R

- (1) Attach the operator in the same manner as described in step 1.
- (2) Attach the rosette assembly to the operator.
- (3) Pressing the rosette from the directions indicated by the arrows, insert the selector tip in the groove.
- (4) Make sure that the selector tip is inserted completely.
- (5) To remove the rosette, use a small flathead screwdriver to remove the selector tip as described in step 3, and then remove the rosette.

Fig. 12

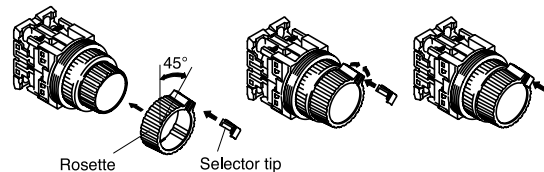

**11. AR30A (joy stick selector)**

- (1) Remove the clamp ring as shown in the following figure.
  - (2) Attach the operator in the same manner as described in step 1.
- Note: Even if a lock type is used, remove the clamp ring in the same manner.

**Fig. 13**

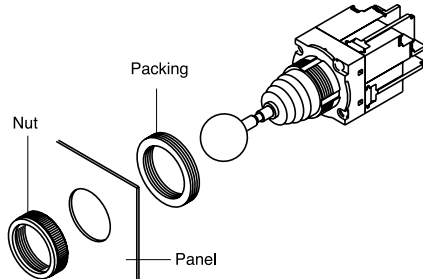

**Water-proof and dust-proof cap**

- Applicable type: Water-proof cap AHX052  
 Dust-proof cap AHX032, 033, 034  
 AHX113  
 AHX157

When attached to the panel in combination with a water-proof or dust-proof cap, the water-proof cap or dust-proof cap may sink downward and prevent the depressed button from returning to its original position.

As shown in the following figure, cut an approximately 5-mm air outlet in the portion of the ring packing touching the panel surface. Also, reduce the number of packing rings by one below the standard number. The clamp ring tightening torque is 1.5 to 2.5 N·m.

**Fig. 14**

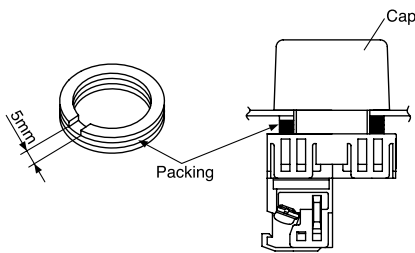

**Degree of protection**

The water-proof cap or dust-proof cap seals the panel surface to provide IP65 protection.

**Applicable panel thickness**

The AR30/DR30 series switches are mountable to panels with the thickness given in the table below.

Switch mounting condition	Applicable panel thickness
Without accessories	1 to 6mm
With accessories   AR9Y003 adapter	2.5 to 5mm

**Using accessory ring-packings**

Use the required number of ring-packings (1.6mm-thick, 4 pieces, resin mold).

Table below is a guideline for using the packings.

If a locking nut or legend plate is used, the thickness must be counted as an additional panel thickness.

**Panel thickness vs. number of packings (reference data)**

Effective panel thickness including lock-ring and legend plate thicknesses	Number of packings
1.0mm to less than 2.0mm	4
2.0mm to less than 3.6mm	3
3.6mm to less than 5.0mm	2
5.0mm to less than 6.0mm	1

**Minimum mounting space, mm**

The minimum mounting spaces required for AR30/DR30 command switches are given below. (Fig. 15)

**Fig. 15**

- Illuminated pushbutton and pushbutton
- Emergency stop illuminated pushbutton and emergency stop pushbutton
- Illuminated and non-illuminated selectors
- Pilot light

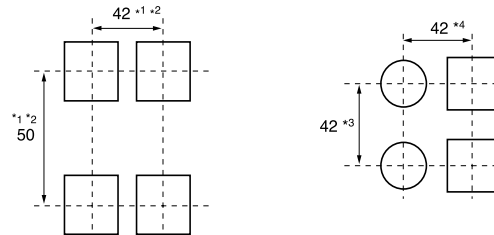

Notes: \*1 AR30M3R, M8R, GSR: 55mm  
 \*2 AR30B□R, GPR, V1R: 80mm

Type	*3	*4
F4M	34	34
F4N (Vertical lengthwise mounting)	40	34
(Horizontal lengthwise mounting)	34	40
M4M	40	40
Pilot lights short-body with transformer	50	42
Pilot lights with resistor	80	42







Other items are the same as for the AR22 and DR22 series, see page 50 to 54.



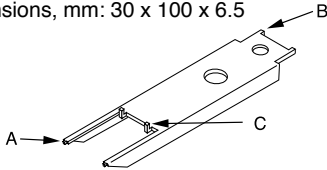



# Pushbuttons/Selectors/Pilot Lights

## AR22/DR22 and AR30/DR30

### Accessories

#### ■ Accessories

Description	Type
Wrench	<p><b>AR9A004</b> Dimensions, mm: 30 x 100 x 6.5</p>  <p>Remarks Section "A" Use this section to tighten the nut for mounting the operator on a panel.</p> <p>Section "B" Use this section to tighten or remove the lens. Applicable type: AR22F0L, F5L, E0L, E5L, F0P, F5P, E0P, E5P AR22G1L, G2L, G4L, G6L, G7L, G9L DR22E3L, E3P AR30E0L, E5L, G2L, G3L, G4L, G7L, G8L, G9L DR30E3L</p> <p>Section "C" Fit the tabs on the section "C" in the center button, and turn the wrench to tighten or remove the button. Applicable type: AR22V (except V4R, VG type) AR30V (except V1R type)</p>  <p>KK02-261</p>
Wrench for AR22, DR22	<p><b>AR9A701</b> Dimensions, mm: <math>\varnothing 28 \times 70</math></p> <p>Application: AR22, DR22 nut tightening</p> 
Wrench	<p><b>AHX536</b> Dimensions, mm: <math>\varnothing 32 \times 76</math></p> <p>Application: DR30F4M, F4N, M4M, N1, N2 nut tightening</p>  <p>KK02-097A</p>
Wrench	<p><b>AR9A001</b> Dimensions, mm: <math>\varnothing 22 \times 35</math></p> <p>Application: AR22, DR22 round-type lens tightening AR22E0M, E5M oil-proof cap tightening AR30, DR30 round-type lens tightening AR30GSR button tightening</p>  <p>KK02-098A</p>
Wrench (for center button)	<p><b>AR9A002</b> Dimensions, mm: <math>\varnothing 18 \times 60</math></p> <p>Application: AR22V center button tightening (except V4R, VG type) AR30V center button tightening (except V1R type)</p> 
Wrench	<p><b>AHX701</b> Dimensions, mm: <math>\varnothing 25 \times 72.5</math></p> <p>Application: DR22N, AR22VG nut tightening</p>  <p>AF03-5</p>

Description	Type
Wrench (for center button)	<p><b>AHX8003</b> Dimensions, mm: <math>\varnothing 14 \times 50</math></p> <p>Attaching and removing the center button of the AR22VGF type.</p>  <p>AF93-6</p>
Wrench for AR22,30 and DR22, 30	<p><b>AR9A006</b> Dimensions, mm: <math>\varnothing 40 \times 100</math></p> <p>To mount an AR22, 30 or DR22, 30 command switch to a panel, use this wrench to tighten the nut securely. It is very easy to fit this wrench onto the nut. The wrench with an inside rubber-lining can be easily used with either your right or left hand.</p> <p>For <math>\varnothing 30</math></p>  <p>For <math>\varnothing 22</math></p> <p>AF96-241</p>
Wrench for AR30, DR30	<p><b>AHX001</b> Dimensions, mm: <math>\varnothing 47 \times 100</math></p> <p>To mount an AR30 or DR30 command switch to a panel, use this wrench to tighten the nut securely.</p>  <p>AF95-467</p>
Special tool	<p><b>AHX321</b> Dimensions, mm: 42 x 130 x 6.5 For all types except pilot lights</p> <p><b>DR9A321-T</b> Dimensions, mm: 57 x 130 x 30 For pilot lights</p> <ul style="list-style-type: none"> <li>This tool is used to remove contact blocks and transformer units.</li> <li>The AHX321 can remove round color lens of switches.</li> </ul>  <p>AHX321</p> <p>SG-873</p>  <p>DR9A321-T</p> <p>AF95-21</p>
Wrench/Lamp changer	<p><b>AHX702</b> Dimensions, mm: <math>\varnothing 36 \times 55</math></p> <p>Use this wrench to tighten or remove the lens and lamp.</p> <p>Used with: Lens of DR22D0L, K0L and DR30D0L, K0L Incandescent lamp of pilot lights and illuminated pushbuttons</p>  <p>SI-1030</p>
Lamp changer	<p><b>AHX790</b> Dimensions, mm: <math>\varnothing 14 \times 55</math></p> <ul style="list-style-type: none"> <li>Use this rubber wrench for mounting or removing lamps from pilot lights and illuminated pushbutton switches.</li> <li>This wrench can be used for both LED and incandescent lamps.</li> <li>One end is for the BA9S/13 lamp, and the other is for the E12/15 lamp (for use with 30mm dia. pilot lights with resistor).</li> <li>For 30mm dia. pilot lights with resistor, this tool can also be used to attach or remove incandescent lamps.</li> </ul> <p>For BA9S/13 lamp</p>  <p>For E12/15 lamp</p> <p>AF95-22</p>

# Pushbuttons/Selectors/Pilot Lights AR22/DR22 and AR30/DR30 Accessories



Description	Type
Protection cover	<p><b>AR9E760</b></p> <p>This cover protects against accidental operation. The cover lid is returned home with a spring force. (Packing is provided)</p> <p>Used with: AR22F0L, F5L, E0L, E5L, F0M, F5M, E0M, E5M, F0P, F5P, E0P, E5P AR22F0R, F5R, E0R, E5R, F0S, F5S, E0S, E5S, E0Y, E5Y, F0Y, F5Y, FAR, FBR, EAR, EBR</p> <p>Dimensions, mm:</p>
Cover for preventing operating errors with 30mm dia. types	<p><b>AR9E538</b></p> <p>Inadvertent operation can be prevented by fitting a transparent cover with chain in the clamp ring.</p> <p>Used with: AR30F0R, F5R, E0R, E5R, E0L, E5L</p> <p>Dimensions, mm:</p>
Cover for preventing operating errors with 30mm dia. types	<p><b>AHX408</b></p> <p>This is a metallic cover for preventing inadvertent operation.</p> <p>Used with: AR30F0R, F5R</p> <p>Dimensions, mm:</p> <p>When attaching the cover to a vertical panel, if you attach it so that the portion indicated by an "A" is at the upper right, the stopper causes the cover to stop above the push button to halt further rotation.</p> <p>The material is steel (zinc plated).</p>

Description	Type
Key washer for AR22, DR22	<p><b>AR9Y715</b></p> <p>Use this metal washer when securing an operator in a 22.3mm dia. panel cutout hole.</p> <p>Dimensions, mm:</p> <ul style="list-style-type: none"> <li>When the periphery of the panel cutout has a hole to stop rotation, use with side A contacting the panel (except for Joy stick selector types).</li> <li>Even when the periphery of the panel cutout does not have a hole to stop rotation, if used with side B contacting the panel it can serve as a washer for eliminating play (except for Joy stick selector types).</li> </ul>
Key washer for ø30	<p><b>AHX082</b></p> <p>Use this metal washer when securing an operator in a 30.5mm dia. panel cutout hole.</p> <p>Dimension, mm:</p>
Operator base cover	<p><b>AR9Y002</b></p> <p>Attach this cover to the operator base of a pushbutton switch with only one contact block (1NO or 1NC) to protect against dust.</p>
Adapter for AR22, DR22	<p><b>AR9Y718</b></p> <p>Use this resin adapter to mount the AR22/DR22 (switch/pilot light) in a 25.5mm dia. cutout hole on a panel.</p> <p>Dimensions, mm:</p>

# Pushbuttons/Selectors/Pilot Lights

## AR22/DR22 and AR30/DR30

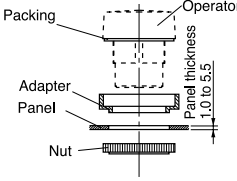
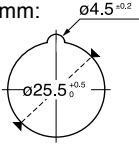
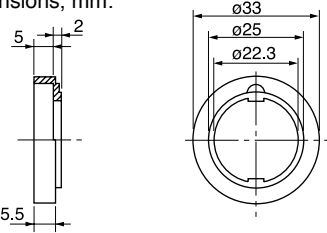
### Accessories

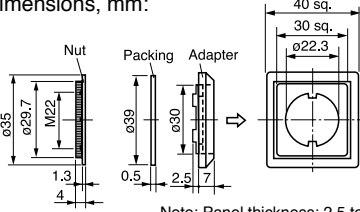
Description	Type
Adapter for AR22 and DR22 	<b>AR9Y008</b> Use this resin adapter to mount the AR22/DR22 (switch/pilot light) in a 25.5mm dia. cutout hole on a panel. Mounting, mm:  Panel cutout, mm:  Equipped with device for stopping rotation Used with: AR22, DR22 round head types (except for M3R, M8R, VG□, joy stick selectors and buzzers) Dimensions, mm: 
Adapter for AR30 and DR30 	<b>AR9Y003</b> Mount this adapter onto a 22mm dia. command switch with a square button and a square bezel to obtain a 30mm dia. command switch with a square/round button and a square bezel. A resin ring-packing and a nut are accessories of the adapter. Dimensions, mm:  Note: Panel thickness: 2.5 to 5mm

AF98-198

AF95-416

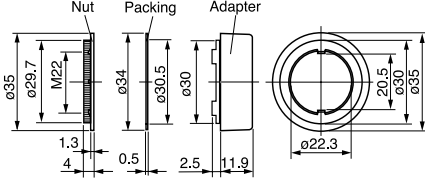
Description	Type
Round-frame adapter for 30mm dia. types 	<b>AR9Y004</b> By using this adapter in combination with the round type 22mm dia. command switch, the 22mm dia. command switch can be used as a 30mm dia. command switch/round frame type. Used with: AR22, DR22 round types (except for M3R, M8R, VG□, Joy stick selectors, buzzers) Dimensions, mm  Note: Panel thickness: 2.5 to 5mm

KK02-100A

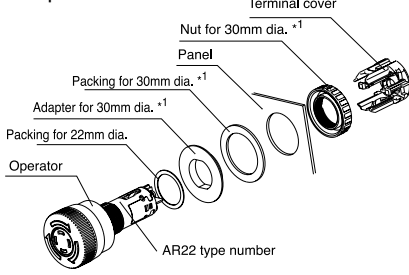
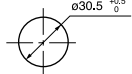
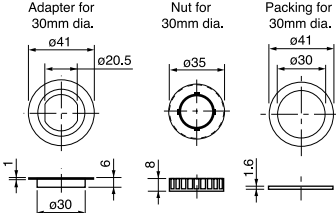
Round-frame adapter for 30mm dia. type VG 	<b>AHX958</b> Using this adapter in combination with model AR22VG (22mm dia.) allows mounting to a 30.5mm panel cutout hole. The attachment method is as follows. <ul style="list-style-type: none"> <li>The washer and nut (22.3mm dia.) originally attached to the operator will not be used, so remove them.</li> <li>Attach the 22mm dia. packing (included), the 30mm dia. adapter and the 30mm dia. packing to the operator in that order, and insert the operator into the cutout hole.</li> <li>From the back of the panel cutout hole, fasten the 30mm-dia. nut using the AHX701 wrench. The correct tightening torque is 1 to 1.5 N·m.</li> </ul>  Panel cutout, mm:  Dimensions, mm:  Note: Panel thickness: 1 to 6mm
---	---

AF93-4

# Pushbuttons/Selectors/Pilot Lights AR22/DR22 and AR30/DR30 Accessories

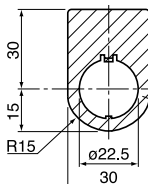
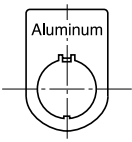
Description	Type																												
Legend plate for AR22  	<b>AR9P711-①②③</b> ① Color B: Black A: Aluminum <hr/> <table border="1" style="width: 100%; border-collapse: collapse;"> <thead> <tr> <th style="width: 15%;">Legend</th> <th style="width: 15%;">Code</th> <th style="width: 15%;">②</th> <th style="width: 15%;">③</th> </tr> </thead> <tbody> <tr><td>Blank</td><td>0</td><td>0</td><td></td></tr> <tr><td>ON</td><td>0</td><td>A</td><td></td></tr> <tr><td>OFF</td><td>0</td><td>B</td><td></td></tr> <tr><td>START</td><td>0</td><td>C</td><td></td></tr> <tr><td>STOP</td><td>0</td><td>D</td><td></td></tr> <tr><td>OFF-ON</td><td>2</td><td>A</td><td></td></tr> </tbody> </table> <hr/> Dimensions, mm: <div style="display: flex; justify-content: space-around; align-items: flex-start;"> <div style="text-align: center;">  <p>AR9P711-B</p> </div> <div style="text-align: center;">  <p>AR9P711-A</p> </div> </div> <p style="text-align: center;">Thickness: 0.8mm</p>	Legend	Code	②	③	Blank	0	0		ON	0	A		OFF	0	B		START	0	C		STOP	0	D		OFF-ON	2	A	
Legend	Code	②	③																										
Blank	0	0																											
ON	0	A																											
OFF	0	B																											
START	0	C																											
STOP	0	D																											
OFF-ON	2	A																											

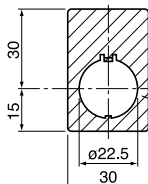
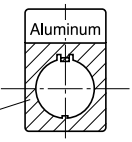
Description	Type																												
Legend plate for AR22  	<b>AR9P712-①②③</b> ① Color B: Black A: Partially black <hr/> <table border="1" style="width: 100%; border-collapse: collapse;"> <thead> <tr> <th style="width: 15%;">Legend</th> <th style="width: 15%;">Code</th> <th style="width: 15%;">②</th> <th style="width: 15%;">③</th> </tr> </thead> <tbody> <tr><td>Blank</td><td>0</td><td>0</td><td></td></tr> <tr><td>ON</td><td>0</td><td>A</td><td></td></tr> <tr><td>OFF</td><td>0</td><td>B</td><td></td></tr> <tr><td>START</td><td>0</td><td>C</td><td></td></tr> <tr><td>STOP</td><td>0</td><td>D</td><td></td></tr> <tr><td>OFF-ON</td><td>2</td><td>A</td><td></td></tr> </tbody> </table> <hr/> Dimensions, mm: <div style="display: flex; justify-content: space-around; align-items: flex-start;"> <div style="text-align: center;">  <p>AR9P712-B</p> </div> <div style="text-align: center;">  <p>AR9P712-A</p> </div> </div> <p style="text-align: center;">Thickness: 0.8mm</p>	Legend	Code	②	③	Blank	0	0		ON	0	A		OFF	0	B		START	0	C		STOP	0	D		OFF-ON	2	A	
Legend	Code	②	③																										
Blank	0	0																											
ON	0	A																											
OFF	0	B																											
START	0	C																											
STOP	0	D																											
OFF-ON	2	A																											

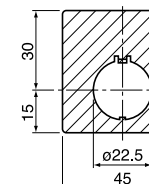
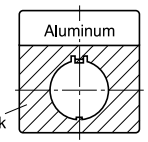
Description	Type																												
Legend plate for AR22  	<b>AR9P713-①②③</b> ① Color B: Black A: Partially black <hr/> <table border="1" style="width: 100%; border-collapse: collapse;"> <thead> <tr> <th style="width: 15%;">Legend</th> <th style="width: 15%;">Code</th> <th style="width: 15%;">②</th> <th style="width: 15%;">③</th> </tr> </thead> <tbody> <tr><td>Blank</td><td>0</td><td>0</td><td></td></tr> <tr><td>ON</td><td>0</td><td>A</td><td></td></tr> <tr><td>OFF</td><td>0</td><td>B</td><td></td></tr> <tr><td>START</td><td>0</td><td>C</td><td></td></tr> <tr><td>STOP</td><td>0</td><td>D</td><td></td></tr> <tr><td>OFF-ON</td><td>2</td><td>A</td><td></td></tr> </tbody> </table> <hr/> Dimensions, mm: <div style="display: flex; justify-content: space-around; align-items: flex-start;"> <div style="text-align: center;">  <p>AR9P713-B</p> </div> <div style="text-align: center;">  <p>AR9P713-A</p> </div> </div> <p style="text-align: center;">Thickness: 0.8mm</p>	Legend	Code	②	③	Blank	0	0		ON	0	A		OFF	0	B		START	0	C		STOP	0	D		OFF-ON	2	A	
Legend	Code	②	③																										
Blank	0	0																											
ON	0	A																											
OFF	0	B																											
START	0	C																											
STOP	0	D																											
OFF-ON	2	A																											

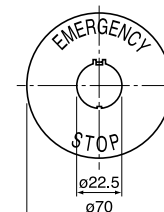
Description	Type																										
Legend plate for AR22 emergency stop  	<b>AR9P719-①②</b> This aluminum legend plate is for a 22.3mm dia. panel cutout hole. (Packing provided) Plate color: Yellow Letter color: Black <hr/> <table border="1" style="width: 100%; border-collapse: collapse;"> <thead> <tr> <th style="width: 15%;">Legend</th> <th style="width: 15%;">Code</th> <th style="width: 15%;">Letter height</th> </tr> <tr> <td></td> <td>①</td> <td>②</td> </tr> </thead> <tbody> <tr><td>Blank</td><td>0</td><td>0</td><td>—</td></tr> <tr><td>EMERGENCY</td><td>5</td><td>A</td><td>7mm</td></tr> <tr><td>STOP</td><td>5</td><td>B</td><td>13mm</td></tr> <tr><td>EMERGENCY</td><td>5</td><td>C</td><td>13mm</td></tr> <tr><td>OFF</td><td></td><td></td><td></td></tr> </tbody> </table> <hr/> Dimensions, mm: <div style="text-align: center;">  <p>AR9P719</p> </div> <p style="text-align: center;">Thickness: 0.8mm</p>	Legend	Code	Letter height		①	②	Blank	0	0	—	EMERGENCY	5	A	7mm	STOP	5	B	13mm	EMERGENCY	5	C	13mm	OFF			
Legend	Code	Letter height																									
	①	②																									
Blank	0	0	—																								
EMERGENCY	5	A	7mm																								
STOP	5	B	13mm																								
EMERGENCY	5	C	13mm																								
OFF																											

Note: Engraving for making letters is not available.

# Pushbuttons/Selectors/Pilot Lights

## AR22/DR22 and AR30/DR30

### Accessories

Description	Type																							
Legend plate for AR22 (width: 34mm)	<p><b>AR9P015-B</b>①② : High 36mm <b>AR9P014-B</b>①② : High 40.3mm</p> <p>Color: black</p> <table border="1"> <thead> <tr> <th rowspan="2">Legend</th> <th colspan="2">code</th> </tr> <tr> <th>①</th> <th>②</th> </tr> </thead> <tbody> <tr> <td>Blank</td> <td>0</td> <td>0</td> </tr> <tr> <td>ON</td> <td>0</td> <td>A</td> </tr> <tr> <td>OFF</td> <td>0</td> <td>B</td> </tr> <tr> <td>START</td> <td>0</td> <td>C</td> </tr> <tr> <td>STOP</td> <td>0</td> <td>D</td> </tr> <tr> <td>OFF-ON</td> <td>2</td> <td>A</td> </tr> </tbody> </table> <p>Optimal for use in combination with a 3-position selector switch. Legend plates are available in two types: short, 36 mm; and long, 40.3mm.</p> <p>Dimensions, mm:</p>	Legend	code		①	②	Blank	0	0	ON	0	A	OFF	0	B	START	0	C	STOP	0	D	OFF-ON	2	A
Legend	code																							
	①	②																						
Blank	0	0																						
ON	0	A																						
OFF	0	B																						
START	0	C																						
STOP	0	D																						
OFF-ON	2	A																						



.AF96-190

Legend plate with name plate for AR22	<p>Legend plate <b>AR9P009-B</b> Name plate <b>AR9P010-B</b> ①② (34 × 8mm)</p> <p>Legend plate <b>AR9P011-B</b> Name plate <b>AR9P012-B</b> ①② (34 × 13mm)</p> <p>Legend plate <b>AR9P007-B</b> Name plate <b>AR9P008-B</b> ①② (27 × 16mm)</p> <table border="1"> <thead> <tr> <th rowspan="2">Name plate</th> <th colspan="2">Code</th> </tr> <tr> <th>①</th> <th>②</th> </tr> </thead> <tbody> <tr> <td>ON</td> <td>0</td> <td>A</td> </tr> <tr> <td>OFF</td> <td>0</td> <td>B</td> </tr> <tr> <td>START</td> <td>0</td> <td>C</td> </tr> <tr> <td>STOP</td> <td>0</td> <td>D</td> </tr> <tr> <td>OFF-ON</td> <td>2</td> <td>A</td> </tr> </tbody> </table> <p>Dimensions, mm:</p>	Name plate	Code		①	②	ON	0	A	OFF	0	B	START	0	C	STOP	0	D	OFF-ON	2	A
Name plate	Code																				
	①	②																			
ON	0	A																			
OFF	0	B																			
START	0	C																			
STOP	0	D																			
OFF-ON	2	A																			



.AF96-190

Description	Type																																			
Legend plate for AR30	<p><b>AHX177-①②③④</b> This legend plate is for a 30.5mm dia. panel cutout hole.</p> <table border="1"> <thead> <tr> <th>Code</th> <th>Material</th> <th>Color</th> </tr> </thead> <tbody> <tr> <td>S</td> <td>Brass</td> <td>Silver</td> </tr> <tr> <td>B</td> <td>Aluminum</td> <td>Black</td> </tr> <tr> <td>A</td> <td></td> <td>Aluminum</td> </tr> </tbody> </table> <p>② Size H: Standard S: Short size</p> <table border="1"> <thead> <tr> <th rowspan="2">Legend</th> <th colspan="2">Code</th> </tr> <tr> <th>③</th> <th>④</th> </tr> </thead> <tbody> <tr> <td>Blank</td> <td>0</td> <td>0</td> </tr> <tr> <td>ON</td> <td>0</td> <td>A</td> </tr> <tr> <td>OFF</td> <td>0</td> <td>B</td> </tr> <tr> <td>START</td> <td>0</td> <td>C</td> </tr> <tr> <td>STOP</td> <td>0</td> <td>D</td> </tr> <tr> <td>OFF-ON</td> <td>2</td> <td>A</td> </tr> </tbody> </table> <p>Dimensions, mm:</p>	Code	Material	Color	S	Brass	Silver	B	Aluminum	Black	A		Aluminum	Legend	Code		③	④	Blank	0	0	ON	0	A	OFF	0	B	START	0	C	STOP	0	D	OFF-ON	2	A
Code	Material	Color																																		
S	Brass	Silver																																		
B	Aluminum	Black																																		
A		Aluminum																																		
Legend	Code																																			
	③	④																																		
Blank	0	0																																		
ON	0	A																																		
OFF	0	B																																		
START	0	C																																		
STOP	0	D																																		
OFF-ON	2	A																																		



Y-1545



AF89-466



AF87-49

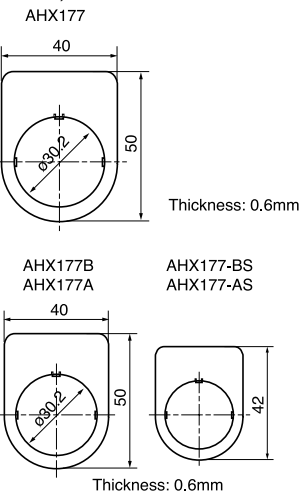

Legend plate for AR30 emergency stop	<p><b>AHX720-①②</b> This aluminum legend plate is for a 30.5mm dia. panel cutout hole.</p> <p>Plate color: Yellow Letter color: Black</p> <table border="1"> <thead> <tr> <th rowspan="2">Legend</th> <th colspan="2">Code</th> <th rowspan="2">Letter height</th> </tr> <tr> <th>①</th> <th>②</th> </tr> </thead> <tbody> <tr> <td>Blank</td> <td>0</td> <td>0</td> <td>—</td> </tr> <tr> <td>EMERGENCY STOP</td> <td>5</td> <td>A</td> <td>7mm</td> </tr> </tbody> </table> <p>Dimensions, mm:</p>	Legend	Code		Letter height	①	②	Blank	0	0	—	EMERGENCY STOP	5	A	7mm
Legend	Code		Letter height												
	①	②													
Blank	0	0	—												
EMERGENCY STOP	5	A	7mm												



SK-598

Note: Engraving for making letters is not available.











# Pushbuttons/Selectors/Pilot Lights

## AR22/DR22 and AR30/DR30

### Accessories





Description	Type																														
Lens for illuminated pushbutton switch and pilot lights  	<table border="1"> <thead> <tr> <th>Type</th> <th>Used with</th> </tr> </thead> <tbody> <tr> <td><b>AR9C011</b>-□*1</td> <td>AR22F0L, F5L, F0P, F5P</td> </tr> <tr> <td><b>AR9C012</b>-□*1</td> <td>AR22E0L, E5L, E0P, E5P AR22G1L, G2L, G4L, G6L, G7L, G9L DR22E3L, E3P AR30E0L, E5L, G2L, G3L, G4L, G7L, G8L, G9L DR30E3L</td> </tr> <tr> <td><b>AR9C013</b>-□*1</td> <td>AR22F0M, F5M</td> </tr> <tr> <td><b>AR9C014</b>-□*1</td> <td>AR22E0M, E5M DR22E3M, F5M</td> </tr> <tr> <td><b>AR9C015</b>-□</td> <td>AR22M4L, M4P</td> </tr> <tr> <td><b>AR9C016</b>-□</td> <td>AR22M0L, M5L</td> </tr> <tr> <td><b>DR9C001</b>-□</td> <td>DR22D0L DR30D0L*2</td> </tr> <tr> <td><b>DR9C002</b>-□</td> <td>DR22K0L DR30K0L*2</td> </tr> <tr> <td><b>DR9C120-C</b></td> <td>DR30M4M</td> </tr> <tr> <td><b>DR9C121-C</b></td> <td>DR30F4N</td> </tr> <tr> <td><b>DR9C122-C</b></td> <td>DR30F4M</td> </tr> <tr> <td><b>DR9C126</b>-□*1</td> <td>DR22F3M</td> </tr> <tr> <td><b>DR9C126-C</b></td> <td>DR22F4M</td> </tr> <tr> <td><b>DR9C127</b>-□*1</td> <td>DR22E3N</td> </tr> </tbody> </table>	Type	Used with	<b>AR9C011</b> -□*1	AR22F0L, F5L, F0P, F5P	<b>AR9C012</b> -□*1	AR22E0L, E5L, E0P, E5P AR22G1L, G2L, G4L, G6L, G7L, G9L DR22E3L, E3P AR30E0L, E5L, G2L, G3L, G4L, G7L, G8L, G9L DR30E3L	<b>AR9C013</b> -□*1	AR22F0M, F5M	<b>AR9C014</b> -□*1	AR22E0M, E5M DR22E3M, F5M	<b>AR9C015</b> -□	AR22M4L, M4P	<b>AR9C016</b> -□	AR22M0L, M5L	<b>DR9C001</b> -□	DR22D0L DR30D0L*2	<b>DR9C002</b> -□	DR22K0L DR30K0L*2	<b>DR9C120-C</b>	DR30M4M	<b>DR9C121-C</b>	DR30F4N	<b>DR9C122-C</b>	DR30F4M	<b>DR9C126</b> -□*1	DR22F3M	<b>DR9C126-C</b>	DR22F4M	<b>DR9C127</b> -□*1	DR22E3N
	Type	Used with																													
	<b>AR9C011</b> -□*1	AR22F0L, F5L, F0P, F5P																													
	<b>AR9C012</b> -□*1	AR22E0L, E5L, E0P, E5P AR22G1L, G2L, G4L, G6L, G7L, G9L DR22E3L, E3P AR30E0L, E5L, G2L, G3L, G4L, G7L, G8L, G9L DR30E3L																													
	<b>AR9C013</b> -□*1	AR22F0M, F5M																													
	<b>AR9C014</b> -□*1	AR22E0M, E5M DR22E3M, F5M																													
	<b>AR9C015</b> -□	AR22M4L, M4P																													
	<b>AR9C016</b> -□	AR22M0L, M5L																													
	<b>DR9C001</b> -□	DR22D0L DR30D0L*2																													
	<b>DR9C002</b> -□	DR22K0L DR30K0L*2																													
	<b>DR9C120-C</b>	DR30M4M																													
	<b>DR9C121-C</b>	DR30F4N																													
	<b>DR9C122-C</b>	DR30F4M																													
	<b>DR9C126</b> -□*1	DR22F3M																													
	<b>DR9C126-C</b>	DR22F4M																													
<b>DR9C127</b> -□*1	DR22E3N																														
	Replace the □ mark by the lens color code <table border="1"> <thead> <tr> <th>Color</th> <th>Green</th> <th>Red</th> <th>Clear</th> <th>Yellow</th> </tr> </thead> <tbody> <tr> <td>Code</td> <td>G</td> <td>R</td> <td>C</td> <td>Y</td> </tr> </tbody> </table> <table border="1"> <thead> <tr> <th>Color</th> <th>Orange</th> <th>Blue</th> <th>White</th> </tr> </thead> <tbody> <tr> <td>Code</td> <td>A</td> <td>S</td> <td>W</td> </tr> </tbody> </table>	Color	Green	Red	Clear	Yellow	Code	G	R	C	Y	Color	Orange	Blue	White	Code	A	S	W												
Color	Green	Red	Clear	Yellow																											
Code	G	R	C	Y																											
Color	Orange	Blue	White																												
Code	A	S	W																												
	Notes: *1 When the main unit code is "W" (white), use a lens of clear color. *2 Except for pilot lights with resistor																														
AF94-458																															
Button for pushbutton switch  	<table border="1"> <thead> <tr> <th>Type</th> <th>Used with</th> </tr> </thead> <tbody> <tr> <td><b>AR9C001</b>-□</td> <td>AR22F0R, F5R, F0Y, F5Y, G2R, G7R AR30F0R, F5R, FVR AR22S1R, S2R, S3R, S6R AR30S1R, S2R, S3R, S6R</td> </tr> <tr> <td><b>AR9C003</b>-□</td> <td>AR22E0R, E5R, G0R, G3R, G5R, G8R AR22E0Y, E5Y AR30E0R, E5R, G0R, G1R, G5R, G6R</td> </tr> <tr> <td><b>AR9C004</b>-□</td> <td>AR22F0S, F5S</td> </tr> <tr> <td><b>AR9C005</b>-□</td> <td>AR22E0S, E5S</td> </tr> <tr> <td><b>AR9C006</b>-□</td> <td>AR22M4R, M9R, M4Y AR30M4R</td> </tr> <tr> <td><b>AR9C007</b>-□</td> <td>AR22M0R, M5R AR30M0R, M3R, M5R, M8R</td> </tr> <tr> <td><b>AR9C024</b>-□</td> <td>AR30B0R, B1R, B2R, B3R</td> </tr> <tr> <td><b>AR9C027-C</b></td> <td>AR22FAR, FBR, AR30FAR, FBR</td> </tr> <tr> <td><b>AR9C028-C</b></td> <td>AR22EAR, EBR, AR30EAR, EBR</td> </tr> <tr> <td><b>AR9C041-R</b></td> <td>AR30N0R</td> </tr> <tr> <td><b>AHX539-1</b></td> <td>Cap for AR30FVR</td> </tr> </tbody> </table>	Type	Used with	<b>AR9C001</b> -□	AR22F0R, F5R, F0Y, F5Y, G2R, G7R AR30F0R, F5R, FVR AR22S1R, S2R, S3R, S6R AR30S1R, S2R, S3R, S6R	<b>AR9C003</b> -□	AR22E0R, E5R, G0R, G3R, G5R, G8R AR22E0Y, E5Y AR30E0R, E5R, G0R, G1R, G5R, G6R	<b>AR9C004</b> -□	AR22F0S, F5S	<b>AR9C005</b> -□	AR22E0S, E5S	<b>AR9C006</b> -□	AR22M4R, M9R, M4Y AR30M4R	<b>AR9C007</b> -□	AR22M0R, M5R AR30M0R, M3R, M5R, M8R	<b>AR9C024</b> -□	AR30B0R, B1R, B2R, B3R	<b>AR9C027-C</b>	AR22FAR, FBR, AR30FAR, FBR	<b>AR9C028-C</b>	AR22EAR, EBR, AR30EAR, EBR	<b>AR9C041-R</b>	AR30N0R	<b>AHX539-1</b>	Cap for AR30FVR						
	Type	Used with																													
	<b>AR9C001</b> -□	AR22F0R, F5R, F0Y, F5Y, G2R, G7R AR30F0R, F5R, FVR AR22S1R, S2R, S3R, S6R AR30S1R, S2R, S3R, S6R																													
	<b>AR9C003</b> -□	AR22E0R, E5R, G0R, G3R, G5R, G8R AR22E0Y, E5Y AR30E0R, E5R, G0R, G1R, G5R, G6R																													
	<b>AR9C004</b> -□	AR22F0S, F5S																													
	<b>AR9C005</b> -□	AR22E0S, E5S																													
	<b>AR9C006</b> -□	AR22M4R, M9R, M4Y AR30M4R																													
	<b>AR9C007</b> -□	AR22M0R, M5R AR30M0R, M3R, M5R, M8R																													
	<b>AR9C024</b> -□	AR30B0R, B1R, B2R, B3R																													
	<b>AR9C027-C</b>	AR22FAR, FBR, AR30FAR, FBR																													
	<b>AR9C028-C</b>	AR22EAR, EBR, AR30EAR, EBR																													
	<b>AR9C041-R</b>	AR30N0R																													
	<b>AHX539-1</b>	Cap for AR30FVR																													
		Replace the □ mark by the button color code <table border="1"> <thead> <tr> <th>Color</th> <th>Green</th> <th>Red</th> <th>Black</th> <th>White</th> </tr> </thead> <tbody> <tr> <td>Code</td> <td>G</td> <td>R</td> <td>B</td> <td>W</td> </tr> </tbody> </table> <table border="1"> <thead> <tr> <th>Color</th> <th>Yellow</th> <th>Orange</th> <th>Blue</th> </tr> </thead> <tbody> <tr> <td>Code</td> <td>Y</td> <td>A</td> <td>S</td> </tr> </tbody> </table>	Color	Green	Red	Black	White	Code	G	R	B	W	Color	Yellow	Orange	Blue	Code	Y	A	S											
	Color	Green	Red	Black	White																										
Code	G	R	B	W																											
Color	Yellow	Orange	Blue																												
Code	Y	A	S																												
AF94-461																															
KK02-101A																															
KK02-102A																															
KK02-103A																															







Description	Type																					
Center button (For V type)  	<table border="1"> <thead> <tr> <th>Type</th> <th>Used with</th> </tr> </thead> <tbody> <tr> <td><b>AR9C020-R</b></td> <td>AR22V0R, V2R, VSR AR30V0R, V2R</td> </tr> <tr> <td><b>AR9C020</b>-□</td> <td>AR22V5R, AR30V5R</td> </tr> <tr> <td><b>AR9C018-R</b></td> <td>AR22V0L, V2L, VDL, VAL, VSL AR30V0L, V2L</td> </tr> <tr> <td><b>AR9C018</b>-□</td> <td>AR22V5L*, AR30V5L*</td> </tr> </tbody> </table>	Type	Used with	<b>AR9C020-R</b>	AR22V0R, V2R, VSR AR30V0R, V2R	<b>AR9C020</b> -□	AR22V5R, AR30V5R	<b>AR9C018-R</b>	AR22V0L, V2L, VDL, VAL, VSL AR30V0L, V2L	<b>AR9C018</b> -□	AR22V5L*, AR30V5L*											
	Type	Used with																				
	<b>AR9C020-R</b>	AR22V0R, V2R, VSR AR30V0R, V2R																				
	<b>AR9C020</b> -□	AR22V5R, AR30V5R																				
	<b>AR9C018-R</b>	AR22V0L, V2L, VDL, VAL, VSL AR30V0L, V2L																				
	<b>AR9C018</b> -□	AR22V5L*, AR30V5L*																				
		Replace the □ mark by the button color code <table border="1"> <thead> <tr> <th>Color</th> <th>Red</th> <th>Black</th> <th>Yellow</th> </tr> </thead> <tbody> <tr> <td>Code</td> <td>R</td> <td>B</td> <td>Y</td> </tr> </tbody> </table> Note: * V5L: Red and yellow only	Color	Red	Black	Yellow	Code	R	B	Y												
	Color	Red	Black	Yellow																		
	Code	R	B	Y																		
	AF95-32																					
	Push-lock, turn-reset button (V and Q types)  	<table border="1"> <thead> <tr> <th>Type</th> <th>Used with</th> </tr> </thead> <tbody> <tr> <td><b>AR9C008-R</b></td> <td>AR22V4R</td> </tr> <tr> <td><b>AR9C010-R</b></td> <td>AR22Q2R, AR30Q2R</td> </tr> <tr> <td><b>AR9C017-R</b></td> <td>AR22V2R, V2L, AR30V2R, V2L</td> </tr> <tr> <td><b>AR9C019-R</b></td> <td>AR22VAL</td> </tr> <tr> <td><b>AR9C021-R</b></td> <td>AR22V0R, V0L, AR30V0R, V0L</td> </tr> <tr> <td><b>AR9C021</b>-□</td> <td>AR22V5R, V5L*, AR30V5R, V5L*</td> </tr> <tr> <td><b>AR9C026-R</b></td> <td>AR22VDL</td> </tr> <tr> <td><b>AR9C029-R</b></td> <td>AR30V1R</td> </tr> <tr> <td><b>AR9C040-R</b></td> <td>AR22VSR, VSL</td> </tr> </tbody> </table>	Type	Used with	<b>AR9C008-R</b>	AR22V4R	<b>AR9C010-R</b>	AR22Q2R, AR30Q2R	<b>AR9C017-R</b>	AR22V2R, V2L, AR30V2R, V2L	<b>AR9C019-R</b>	AR22VAL	<b>AR9C021-R</b>	AR22V0R, V0L, AR30V0R, V0L	<b>AR9C021</b> -□	AR22V5R, V5L*, AR30V5R, V5L*	<b>AR9C026-R</b>	AR22VDL	<b>AR9C029-R</b>	AR30V1R	<b>AR9C040-R</b>	AR22VSR, VSL
		Type	Used with																			
		<b>AR9C008-R</b>	AR22V4R																			
		<b>AR9C010-R</b>	AR22Q2R, AR30Q2R																			
		<b>AR9C017-R</b>	AR22V2R, V2L, AR30V2R, V2L																			
<b>AR9C019-R</b>		AR22VAL																				
<b>AR9C021-R</b>		AR22V0R, V0L, AR30V0R, V0L																				
<b>AR9C021</b> -□		AR22V5R, V5L*, AR30V5R, V5L*																				
<b>AR9C026-R</b>		AR22VDL																				
<b>AR9C029-R</b>		AR30V1R																				
<b>AR9C040-R</b>		AR22VSR, VSL																				
		Replace the □ mark by the button color code <table border="1"> <thead> <tr> <th>Color</th> <th>Red</th> <th>Black</th> <th>Yellow</th> </tr> </thead> <tbody> <tr> <td>Code</td> <td>R</td> <td>B</td> <td>Y</td> </tr> </tbody> </table> Note: * V5L: Red and yellow only	Color	Red	Black	Yellow	Code	R	B	Y												
Color		Red	Black	Yellow																		
Code		R	B	Y																		
AF95-31																						
KK02-104A																						
Knob  	<table border="1"> <thead> <tr> <th>Type</th> <th>Used with</th> </tr> </thead> <tbody> <tr> <td><b>AR9M006</b>-□</td> <td>AR22PR, PCR, PY, PCY AR30PR, PCR</td> </tr> </tbody> </table>	Type	Used with	<b>AR9M006</b> -□	AR22PR, PCR, PY, PCY AR30PR, PCR																	
	Type	Used with																				
	<b>AR9M006</b> -□	AR22PR, PCR, PY, PCY AR30PR, PCR																				
		Replace the □ mark by the knob color code <table border="1"> <thead> <tr> <th>Color</th> <th>Black</th> <th>Green</th> <th>Red</th> </tr> </thead> <tbody> <tr> <td>Code</td> <td>B</td> <td>G</td> <td>R</td> </tr> </tbody> </table>	Color	Black	Green	Red	Code	B	G	R												
	Color	Black	Green	Red																		
	Code	B	G	R																		
	AF95-43																					
	Lever  	<table border="1"> <thead> <tr> <th>Type</th> <th>Used with</th> </tr> </thead> <tbody> <tr> <td><b>AR9M007</b>-□</td> <td>AR22WR, WCR, WY, WCY AR30WR, WCR</td> </tr> </tbody> </table>	Type	Used with	<b>AR9M007</b> -□	AR22WR, WCR, WY, WCY AR30WR, WCR																
		Type	Used with																			
		<b>AR9M007</b> -□	AR22WR, WCR, WY, WCY AR30WR, WCR																			
			Replace the □ mark by the lever color code <table border="1"> <thead> <tr> <th>Color</th> <th>Black</th> <th>Green</th> <th>Red</th> </tr> </thead> <tbody> <tr> <td>Code</td> <td>B</td> <td>G</td> <td>R</td> </tr> </tbody> </table>	Color	Black	Green	Red	Code	B	G	R											
		Color	Black	Green	Red																	
		Code	B	G	R																	
		AF95-42																				
		Cylindrical knob  	<table border="1"> <thead> <tr> <th>Type</th> <th>Used with</th> </tr> </thead> <tbody> <tr> <td><b>AR9M008</b>-□</td> <td>AR22RR, RCR, RY, RCY</td> </tr> </tbody> </table>	Type	Used with	<b>AR9M008</b> -□	AR22RR, RCR, RY, RCY															
Type			Used with																			
<b>AR9M008</b> -□			AR22RR, RCR, RY, RCY																			
			Replace the □ mark by the knob color code <table border="1"> <thead> <tr> <th>Color</th> <th>Black</th> <th>Green</th> <th>Red</th> </tr> </thead> <tbody> <tr> <td>Code</td> <td>B</td> <td>G</td> <td>R</td> </tr> </tbody> </table>	Color	Black	Green	Red	Code	B	G	R											
Color			Black	Green	Red																	
Code			B	G	R																	
AF95-44																						

# Pushbuttons/Selectors/Pilot Lights

## AR22/DR22 and AR30/DR30

### Accessories

<p>Description</p> <p>Knob (for illuminated selector switch)</p>  <p style="text-align: right; font-size: small;">AF94-465</p>	<p>Type</p> <table border="1" style="width: 100%;"> <tr> <th>Type</th> <th>Used with</th> </tr> <tr> <td><b>AR9M005</b>-□</td> <td>AR22PL, PP AR30PL</td> </tr> </table> <p>Replace the □ mark by the knob color code</p> <table border="1" style="width: 100%;"> <tr> <td>Color</td> <td>Green</td> <td>Red</td> <td>White</td> </tr> <tr> <td>Code</td> <td>G</td> <td>R</td> <td>W</td> </tr> </table> <table border="1" style="width: 100%;"> <tr> <td>Color</td> <td>Yellow</td> <td>Orange</td> <td>Blue</td> </tr> <tr> <td>Code</td> <td>Y</td> <td>A</td> <td>S</td> </tr> </table>	Type	Used with	<b>AR9M005</b> -□	AR22PL, PP AR30PL	Color	Green	Red	White	Code	G	R	W	Color	Yellow	Orange	Blue	Code	Y	A	S																			
Type	Used with																																							
<b>AR9M005</b> -□	AR22PL, PP AR30PL																																							
Color	Green	Red	White																																					
Code	G	R	W																																					
Color	Yellow	Orange	Blue																																					
Code	Y	A	S																																					
<p>Key</p>  <p style="text-align: right; font-size: small;">AF94-464</p>	<p>Type</p> <table border="1" style="width: 100%;"> <tr> <th>Type</th> <th>Used with</th> </tr> <tr> <td><b>AR9C022</b>-□</td> <td>AR22JR, JCR, AR30JR, JCR,</td> </tr> <tr> <td><b>AR9C025</b>-□</td> <td>AR22JAR, AR30JAR</td> </tr> </table> <p>Replace the □ mark by the key type code. Code: A, B, C, D, E or F, 6 types.</p>	Type	Used with	<b>AR9C022</b> -□	AR22JR, JCR, AR30JR, JCR,	<b>AR9C025</b> -□	AR22JAR, AR30JAR																																	
Type	Used with																																							
<b>AR9C022</b> -□	AR22JR, JCR, AR30JR, JCR,																																							
<b>AR9C025</b> -□	AR22JAR, AR30JAR																																							
<p>Legend plate (for F type with round bezel)</p>  <p style="text-align: right; font-size: small;">AF94-459</p>	<p><b>AR9P001-W</b></p> <p>This part is made of acrylic resin. Use paint or thinner compatible with resin.</p> <p>Dimensions, mm: <math>\phi 17.8 \times 0.9</math></p>																																							
<p>Legend plate (for E type with round bezel)</p>  <p style="text-align: right; font-size: small;">AF94-459</p>	<p><b>AR9P002-W</b></p> <p>This part is made of acrylic resin. Use paint or thinner compatible with resin.</p> <p>Dimensions, mm: <math>\phi 19.7 \times 4.2</math></p>																																							
<p>Symbol mark plate</p>  <p style="text-align: right; font-size: small;">AF98-197</p>	<table border="1" style="width: 100%;"> <tr> <th>Type</th> <th>Used with</th> </tr> <tr> <td><b>AR9P019</b>-□ □ ■</td> <td>AR22FAR, FBR, AR30FAR, FBR</td> </tr> <tr> <td><b>AR9P020</b>-□ □ ■</td> <td>AR22EAR, EBR, AR30EAR, EBR</td> </tr> </table> <p>□ □ ■ :</p> <table border="1" style="width: 100%;"> <tr> <td>Symbol</td> <td>○</td> <td>I</td> <td>⊕</td> <td>○</td> <td>I</td> <td>⊕</td> </tr> <tr> <td>Plate</td> <td>W</td> <td>B</td> <td>W</td> <td>B</td> <td>W</td> <td>B</td> <td>Clear</td> </tr> <tr> <td>Symbol</td> <td>Red</td> <td>Green</td> <td>Green</td> <td>Black</td> <td></td> <td></td> <td></td> </tr> <tr> <td>Code</td> <td>01</td> <td>02</td> <td>03</td> <td>04</td> <td>11</td> <td>12</td> <td>02B</td> <td>04B</td> <td>12B</td> </tr> </table> <p>W: White, B: black</p>	Type	Used with	<b>AR9P019</b> -□ □ ■	AR22FAR, FBR, AR30FAR, FBR	<b>AR9P020</b> -□ □ ■	AR22EAR, EBR, AR30EAR, EBR	Symbol	○	I	⊕	○	I	⊕	Plate	W	B	W	B	W	B	Clear	Symbol	Red	Green	Green	Black				Code	01	02	03	04	11	12	02B	04B	12B
Type	Used with																																							
<b>AR9P019</b> -□ □ ■	AR22FAR, FBR, AR30FAR, FBR																																							
<b>AR9P020</b> -□ □ ■	AR22EAR, EBR, AR30EAR, EBR																																							
Symbol	○	I	⊕	○	I	⊕																																		
Plate	W	B	W	B	W	B	Clear																																	
Symbol	Red	Green	Green	Black																																				
Code	01	02	03	04	11	12	02B	04B	12B																															



<p>Description</p> <p>Legend plate and color plate (for F type with square bezel)</p>  <p style="text-align: right; font-size: small;">AF94-460</p>  <p style="text-align: right; font-size: small;">KK02-105A</p>  <p style="text-align: right; font-size: small;">KK02-106A</p>  <p style="text-align: right; font-size: small;">KK02-107A</p>	<p>Type</p> <ul style="list-style-type: none"> <li>• Legend plate</li> </ul> <table border="1" style="width: 100%;"> <tr> <th>Type</th> <th>Used with</th> </tr> <tr> <td><b>DR9P241-W</b></td> <td>AR22F0M, F5M DR22F3M, F4M</td> </tr> <tr> <td><b>DR9P242-WP</b></td> <td>DR30M4M</td> </tr> <tr> <td><b>DR9P242-W</b></td> <td>DR30M4M, LED(W)</td> </tr> <tr> <td><b>DR9P243-WP</b></td> <td>DR30F4N</td> </tr> <tr> <td><b>DR9P243-W</b></td> <td>DR30F4N, LED(W)</td> </tr> <tr> <td><b>DR9P244-WP</b></td> <td>DR30F4M</td> </tr> <tr> <td><b>DR9P244-W</b></td> <td>DR30F4M, LED(W)</td> </tr> </table> <p>Types DR9P242, 243 and 244-W are LED illuminated, and used exclusively with operators having a "W" in the type number.</p> <ul style="list-style-type: none"> <li>• color plate</li> </ul> <table border="1" style="width: 100%;"> <tr> <th>Type</th> <th>Used with</th> </tr> <tr> <td><b>DR9P241</b>-□</td> <td>DR22F3M, F4M</td> </tr> <tr> <td><b>DR9P242</b>-□</td> <td>DR30M4M</td> </tr> <tr> <td><b>DR9P243</b>-□</td> <td>DR30F4N</td> </tr> <tr> <td><b>DR9P244</b>-□</td> <td>DR30F4M</td> </tr> </table> <p>Replace the □ mark by the color code</p> <table border="1" style="width: 100%;"> <tr> <td>Color</td> <td>Green</td> <td>Red</td> <td>White</td> </tr> <tr> <td>Code</td> <td>G</td> <td>R</td> <td>W</td> </tr> </table> <table border="1" style="width: 100%;"> <tr> <td>Color</td> <td>Yellow</td> <td>Orange</td> <td>Blue</td> </tr> <tr> <td>Code</td> <td>Y</td> <td>A</td> <td>S</td> </tr> </table> <p>This part is made of acrylic resin. Use paint or thinner compatible with resin.</p> <p>Dimensions, mm:  DR9P241: 20.8 sq. x 0.8  DR9P242: 33.4 sq. x 1  DR9P243: 33.4 x 27.4 x 1  DR9P244: 27.4 sq. x 1</p>	Type	Used with	<b>DR9P241-W</b>	AR22F0M, F5M DR22F3M, F4M	<b>DR9P242-WP</b>	DR30M4M	<b>DR9P242-W</b>	DR30M4M, LED(W)	<b>DR9P243-WP</b>	DR30F4N	<b>DR9P243-W</b>	DR30F4N, LED(W)	<b>DR9P244-WP</b>	DR30F4M	<b>DR9P244-W</b>	DR30F4M, LED(W)	Type	Used with	<b>DR9P241</b> -□	DR22F3M, F4M	<b>DR9P242</b> -□	DR30M4M	<b>DR9P243</b> -□	DR30F4N	<b>DR9P244</b> -□	DR30F4M	Color	Green	Red	White	Code	G	R	W	Color	Yellow	Orange	Blue	Code	Y	A	S
Type	Used with																																										
<b>DR9P241-W</b>	AR22F0M, F5M DR22F3M, F4M																																										
<b>DR9P242-WP</b>	DR30M4M																																										
<b>DR9P242-W</b>	DR30M4M, LED(W)																																										
<b>DR9P243-WP</b>	DR30F4N																																										
<b>DR9P243-W</b>	DR30F4N, LED(W)																																										
<b>DR9P244-WP</b>	DR30F4M																																										
<b>DR9P244-W</b>	DR30F4M, LED(W)																																										
Type	Used with																																										
<b>DR9P241</b> -□	DR22F3M, F4M																																										
<b>DR9P242</b> -□	DR30M4M																																										
<b>DR9P243</b> -□	DR30F4N																																										
<b>DR9P244</b> -□	DR30F4M																																										
Color	Green	Red	White																																								
Code	G	R	W																																								
Color	Yellow	Orange	Blue																																								
Code	Y	A	S																																								
<p>Legend plate (for E type with square bezel)</p>  <p style="text-align: right; font-size: small;">AF94-460</p>  <p style="text-align: right; font-size: small;">AF94-460</p>	<table border="1" style="width: 100%;"> <tr> <th>Type</th> <th>Used with</th> </tr> <tr> <td><b>AR9P003-W</b></td> <td>AR22E0M, E5M DR22F5M, E3M</td> </tr> <tr> <td><b>DR9P001-W</b></td> <td>DR22E3N</td> </tr> </table> <p>This part is made of acrylic resin. Use paint or thinner compatible with resin.</p> <p>Dimensions, mm:  AR9P003-W: 20 sq. x 4.8  DR9P001-W: 19.7 x 26.7 x 4.5</p>	Type	Used with	<b>AR9P003-W</b>	AR22E0M, E5M DR22F5M, E3M	<b>DR9P001-W</b>	DR22E3N																																				
Type	Used with																																										
<b>AR9P003-W</b>	AR22E0M, E5M DR22F5M, E3M																																										
<b>DR9P001-W</b>	DR22E3N																																										
<p>Legend sheet</p>  <p style="text-align: right; font-size: small;">AF95-34</p>	<p><b>AHX727</b></p> <p>Affix this seal to the DR9P241-□/AR9P003 legend plate for marking or labeling.</p> <p>Dimensions, mm: 20 sq. x 0.025</p>																																										

# Pushbuttons/Selectors/Pilot Lights

## AR22/DR22 and AR30/DR30

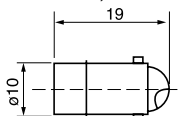
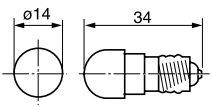
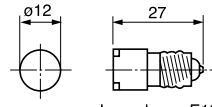
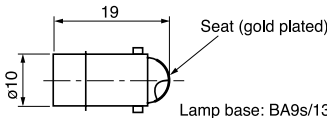
### Accessories

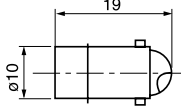

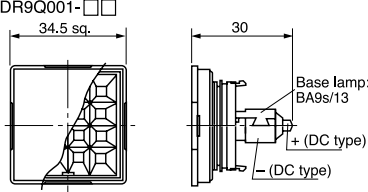
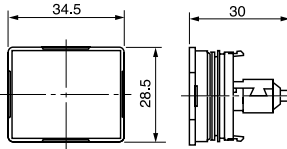
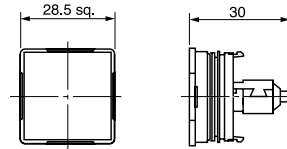



Description	Type	
LED lamp 	Type                      Lamp voltage	
	<b>APX510-6</b> □      6V AC	
	<b>APX510-D6</b> □    6V DC	
	<b>APX510-12</b> □    12V AC/DC	
	<b>APX510-15</b> □    15V AC/DC	
	<b>APX510-24</b> □    24V AC/DC	
	Replace the □ mark by the luminous color code	
	Luminous color	Yellow    Red    Green
	Code	Y        R        G
	Lens color	Y        R        G
Luminous color	Amber    Orange    Blue	
Code	A        O        S	
Lens color	A        W, A*    S	
* Orange is available only for the DR22F4M pilot light.		
Dimensions, mm: 		
Lamp base: BA9s/13		
KK02-109A		
LED lamp (for DR30 with resistor)	Type                      Lamp voltage	
	<b>APX507-24</b> □    24V AC/DC	
	<b>APX509-24O</b>	
	Note: The symbol in the box indicates the color of light emitted. (See note APX510.) When the code is "W" (white), use an LED lamp ((APX.509-24O)	
	Dimensions, mm: 	
		
	Lamp base: E12/15	
	KK02-110A	
	KK02-111A	
	LED lamp (for AR22VGF type)	Type                      Lamp voltage
<b>AR9L002-ER</b> 24V AC/DC		
Luminous color: Red		
Dimensions, mm: 		
Lamp base: BA9s/13		
Do not use the LED lamp for other types.		
KK02-109A		

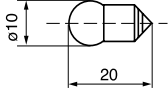

Description	Type	
Neon lamp (for AR22VGF type) 	Type                      Lamp voltage	
	<b>AR9N001-HA</b> 110V AC	
	<b>AR9N001-KA</b> 120V AC	
	<b>AR9N001-MA</b> 220V AC	
	<b>AR9N001-PA</b> 240V AC	
	Luminous color: Orange	
	Dimensions, mm: 	
	Lamp base: BA9s/13	
	Do not use the LED lamp for other types.	
	KK03-038	
LED unit for DR30 (square type) 	Type                      Lamp voltage      Used with	
	<b>DR9Q001-6</b> □    6V DC            DR30M4M	
	<b>DR9Q001-2</b> □    12V AC	
	<b>DR9Q001-B</b> □    12V AC/DC	
	<b>DR9Q001-E</b> □    24V AC/DC	
	<b>DR9Q002-6</b> □    6V DC            DR30F4N	
	<b>DR9Q002-2</b> □    12V AC	
	<b>DR9Q002-B</b> □    12V AC/DC	
	<b>DR9Q002-E</b> □    24V AC/DC	
	<b>DR9Q003-6</b> □    6V DC            DR30F4M	
<b>DR9Q003-2</b> □    12V AC		
<b>DR9Q003-B</b> □    12V AC/DC		
<b>DR9Q003-E</b> □    24V AC/DC		
Replace the □ mark by the luminous color code		
Luminous color	Yellow    Red    Orange    Amber	
Code	Y        R        O        A	
Lens color	G, Y    R        W        A	
Dimensions, mm: 		
Base lamp: BA9s/13 + (DC type) - (DC type)		
		
		
KK02-112A		
KK02-113A		

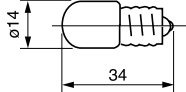
# Pushbuttons/Selectors/Pilot Lights

## AR22/DR22 and AR30/DR30

### Accessories

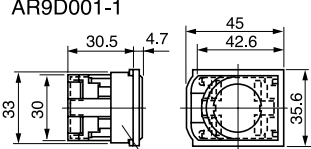
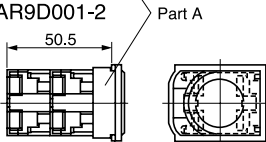
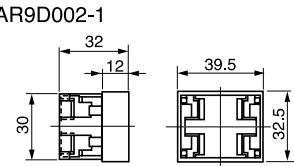
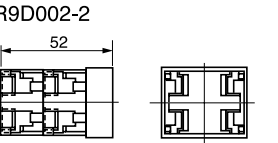



Description	Type															
Incandescent lamp 	<table border="1"> <thead> <tr> <th>Type</th> <th>Lamp voltage</th> <th>Rated voltage, consumption</th> </tr> </thead> <tbody> <tr> <td><b>AHX135</b></td> <td>5.5V AC/DC</td> <td>6.3V AC/DC, 1W</td> </tr> <tr> <td><b>AHX279</b></td> <td>15V AC/DC</td> <td>18V AC/DC, 1W</td> </tr> <tr> <td><b>AHX144</b></td> <td>20V AC/DC</td> <td>24V AC/DC, 1W</td> </tr> <tr> <td><b>AHX129</b></td> <td>24V AC/DC</td> <td>30V AC/DC, 1W</td> </tr> </tbody> </table>	Type	Lamp voltage	Rated voltage, consumption	<b>AHX135</b>	5.5V AC/DC	6.3V AC/DC, 1W	<b>AHX279</b>	15V AC/DC	18V AC/DC, 1W	<b>AHX144</b>	20V AC/DC	24V AC/DC, 1W	<b>AHX129</b>	24V AC/DC	30V AC/DC, 1W
	Type	Lamp voltage	Rated voltage, consumption													
	<b>AHX135</b>	5.5V AC/DC	6.3V AC/DC, 1W													
	<b>AHX279</b>	15V AC/DC	18V AC/DC, 1W													
	<b>AHX144</b>	20V AC/DC	24V AC/DC, 1W													
<b>AHX129</b>	24V AC/DC	30V AC/DC, 1W														
Dimensions, mm: 																
Lamp base: BA9s/13																
AF94-427																
Incandescent lamp (for DR30 with resistor) 	<table border="1"> <thead> <tr> <th>Type</th> <th>Lamp voltage</th> <th>Rated voltage, consumption</th> </tr> </thead> <tbody> <tr> <td><b>AHX130</b></td> <td>15V AC/DC</td> <td>18V AC/DC, 2W</td> </tr> </tbody> </table>	Type	Lamp voltage	Rated voltage, consumption	<b>AHX130</b>	15V AC/DC	18V AC/DC, 2W									
	Type	Lamp voltage	Rated voltage, consumption													
<b>AHX130</b>	15V AC/DC	18V AC/DC, 2W														
Dimensions, mm: 																
Lamp base: E12/15																
KK02-115A																
Contact block (1NO) 	<table border="1"> <thead> <tr> <th>Type</th> <th>Standard</th> </tr> </thead> <tbody> <tr> <td><b>AR9B290</b></td> <td>Standard</td> </tr> <tr> <td><b>AR9B290-S</b></td> <td>Overlap</td> </tr> </tbody> </table>	Type	Standard	<b>AR9B290</b>	Standard	<b>AR9B290-S</b>	Overlap									
	Type	Standard														
<b>AR9B290</b>	Standard															
<b>AR9B290-S</b>	Overlap															
Color: Blue Dimensions, mm: 19.3 x 29 x 27 Note: Terminal cover is not supplied with this.																
AF94-455																
Contact block (1NC) 	<table border="1"> <thead> <tr> <th>Type</th> <th>Standard</th> </tr> </thead> <tbody> <tr> <td><b>AR9B291</b></td> <td>Standard</td> </tr> <tr> <td><b>AR9B291-S</b></td> <td>Overlap</td> </tr> </tbody> </table>	Type	Standard	<b>AR9B291</b>	Standard	<b>AR9B291-S</b>	Overlap									
	Type	Standard														
<b>AR9B291</b>	Standard															
<b>AR9B291-S</b>	Overlap															
Color: Red Dimensions, mm: 19.3 x 29 x 27 Note: Terminal cover is not supplied with this.																
AF94-455																
Lamp terminal 	<table border="1"> <thead> <tr> <th>Type</th> <th>Standard</th> </tr> </thead> <tbody> <tr> <td><b>AR9B292</b></td> <td>Standard</td> </tr> </tbody> </table>	Type	Standard	<b>AR9B292</b>	Standard											
	Type	Standard														
<b>AR9B292</b>	Standard															
Color: Black Dimensions, mm: 19.3 x 29 x 27 Note: Terminal cover is not supplied with this.																
AF94-456																





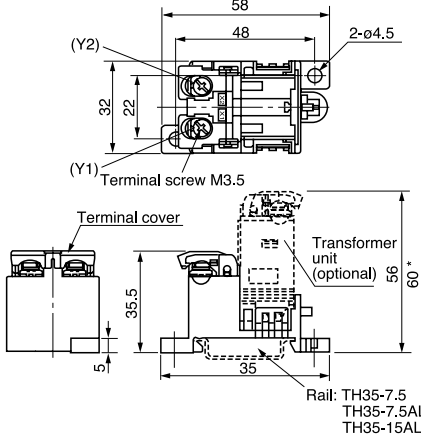



Description	Type																																											
Contact protection cover 	<table border="1"> <thead> <tr> <th>Type</th> <th>Used with *</th> </tr> </thead> <tbody> <tr> <td><b>AR9D001-1</b></td> <td>AR22, 1-step contact</td> </tr> <tr> <td><b>AR9D001-2</b></td> <td>AR22, 2-step contact</td> </tr> <tr> <td><b>AR9D002-1</b></td> <td>AR30, 1-step contact</td> </tr> <tr> <td><b>AR9D002-2</b></td> <td>AR30, 2-step contact</td> </tr> </tbody> </table>	Type	Used with *	<b>AR9D001-1</b>	AR22, 1-step contact	<b>AR9D001-2</b>	AR22, 2-step contact	<b>AR9D002-1</b>	AR30, 1-step contact	<b>AR9D002-2</b>	AR30, 2-step contact																																	
	Type	Used with *																																										
	<b>AR9D001-1</b>	AR22, 1-step contact																																										
	<b>AR9D001-2</b>	AR22, 2-step contact																																										
	<b>AR9D002-1</b>	AR30, 1-step contact																																										
	<b>AR9D002-2</b>	AR30, 2-step contact																																										
	<ul style="list-style-type: none"> <li>The contact is covered with a silicon rubber cover to keep out foreign matter such as dust, etc.</li> <li>Section A of the AR9D001 is separate.</li> </ul> * See page 119, "AR22 □ Z8, AR30 □ Z8"																																											
	Dimensions, mm: 																																											
	AR9D001-1 																																											
	AR9D001-2 																																											
AR9D002-1 																																												
AR9D002-2 																																												
KK02-117A																																												
Transformer unit 	<table border="1"> <thead> <tr> <th>Type</th> <th>Primary voltage</th> <th>Used with</th> </tr> </thead> <tbody> <tr> <td><b>AR9T511-H</b></td> <td>100-110V AC</td> <td rowspan="2">Standard type (except buzzers)</td> </tr> <tr> <td><b>AR9T511-L</b></td> <td>115-127V AC</td> </tr> <tr> <td><b>AR9T511-M</b></td> <td>200-220V AC</td> <td rowspan="2">Standard type (except buzzers)</td> </tr> <tr> <td><b>AR9T511-Q</b></td> <td>230-254V AC</td> </tr> <tr> <td><b>AR9T511-S</b></td> <td>350-380V AC</td> <td rowspan="2">Standard type (except buzzers)</td> </tr> <tr> <td><b>AR9T511-T</b></td> <td>400-440V AC</td> </tr> <tr> <td><b>AR9T511-V</b></td> <td>480V AC</td> <td rowspan="2">Standard type (except buzzers)</td> </tr> <tr> <td><b>AR9T511-W</b></td> <td>500-550V AC</td> </tr> <tr> <td><b>AR9T557-H</b></td> <td>100-110V AC</td> <td rowspan="2">DR30F4N, F4M, M4M</td> </tr> <tr> <td><b>AR9T557-L</b></td> <td>115-127V AC</td> </tr> <tr> <td><b>AR9T557-M</b></td> <td>200-220V AC</td> <td rowspan="2">Standard type (except buzzers)</td> </tr> <tr> <td><b>AR9T557-Q</b></td> <td>230-254V AC</td> </tr> <tr> <td><b>AR9T557-S</b></td> <td>350-380V AC</td> <td rowspan="2">Standard type (except buzzers)</td> </tr> <tr> <td><b>AR9T557-T</b></td> <td>400-440V AC</td> </tr> <tr> <td><b>AR9T557-V</b></td> <td>480V AC</td> <td rowspan="2">Standard type (except buzzers)</td> </tr> <tr> <td><b>AR9T557-W</b></td> <td>500-550V AC</td> </tr> </tbody> </table>	Type	Primary voltage	Used with	<b>AR9T511-H</b>	100-110V AC	Standard type (except buzzers)	<b>AR9T511-L</b>	115-127V AC	<b>AR9T511-M</b>	200-220V AC	Standard type (except buzzers)	<b>AR9T511-Q</b>	230-254V AC	<b>AR9T511-S</b>	350-380V AC	Standard type (except buzzers)	<b>AR9T511-T</b>	400-440V AC	<b>AR9T511-V</b>	480V AC	Standard type (except buzzers)	<b>AR9T511-W</b>	500-550V AC	<b>AR9T557-H</b>	100-110V AC	DR30F4N, F4M, M4M	<b>AR9T557-L</b>	115-127V AC	<b>AR9T557-M</b>	200-220V AC	Standard type (except buzzers)	<b>AR9T557-Q</b>	230-254V AC	<b>AR9T557-S</b>	350-380V AC	Standard type (except buzzers)	<b>AR9T557-T</b>	400-440V AC	<b>AR9T557-V</b>	480V AC	Standard type (except buzzers)	<b>AR9T557-W</b>	500-550V AC
	Type	Primary voltage	Used with																																									
	<b>AR9T511-H</b>	100-110V AC	Standard type (except buzzers)																																									
	<b>AR9T511-L</b>	115-127V AC																																										
	<b>AR9T511-M</b>	200-220V AC	Standard type (except buzzers)																																									
	<b>AR9T511-Q</b>	230-254V AC																																										
	<b>AR9T511-S</b>	350-380V AC	Standard type (except buzzers)																																									
	<b>AR9T511-T</b>	400-440V AC																																										
	<b>AR9T511-V</b>	480V AC	Standard type (except buzzers)																																									
	<b>AR9T511-W</b>	500-550V AC																																										
<b>AR9T557-H</b>	100-110V AC	DR30F4N, F4M, M4M																																										
<b>AR9T557-L</b>	115-127V AC																																											
<b>AR9T557-M</b>	200-220V AC	Standard type (except buzzers)																																										
<b>AR9T557-Q</b>	230-254V AC																																											
<b>AR9T557-S</b>	350-380V AC	Standard type (except buzzers)																																										
<b>AR9T557-T</b>	400-440V AC																																											
<b>AR9T557-V</b>	480V AC	Standard type (except buzzers)																																										
<b>AR9T557-W</b>	500-550V AC																																											
Dimensions, mm: Up to 220 V 22.4 x 30 x 45 Over 220 V 25.3 x 29 x 48																																												
Note: With terminal cover																																												
AF94-457																																												
																																												
AF95-33																																												

# Pushbuttons/Selectors/Pilot Lights



## AR22/DR22 and AR30/DR30

### Accessories

<p>Description</p> <p>Base unit for transformer separate mounting</p>  <p>KK02-118A</p>	<p>Type</p> <p><b>AR9T003</b></p> <p>Use this base in combination with a transformer unit. This base unit can be mounted using screws or rails.</p> <p>Dimensions, mm</p>  <p>* Except for the types 110V AC, 127V AC and 220V AC.</p>									
<p>Resistor</p> <p>Voltage stabilizer</p> <p>Device for LED lamp flickering</p>  <p>AF95-33</p>	<p>Resistor: <b>AR9T519-H</b> (110V DC) Fit this resistor when using LED of 24V DC rating with 110V DC power.</p> <p>Voltage stabilizer: <b>AR9T001-E</b> This unit allows an LED lamp of 24V DC rating to be used in a circuit with voltage from 27V to 35V (AC or DC).</p> <p>Flickering device:</p> <p>6V AC: <b>AR9T002-A</b> 6V DC: <b>AR9T002-6</b> 12 to 24V AC: <b>AR9T002-G *</b> 12 to 24V DC: <b>AR9T002-E *</b></p> <p>* Used in combination with 12V, 15V, or 24V rated LED lamp.</p> <p>Note: With terminal cover</p>									
<p>Nut</p>  <p>AF94-462</p>  <p>KK2-119A</p>	<table border="1"> <thead> <tr> <th>Type</th> <th>Used with</th> <th>Dimensions, mm</th> </tr> </thead> <tbody> <tr> <td><b>AR9R744</b></td> <td>AR22, DR22*</td> <td>ø29.7 x 4</td> </tr> <tr> <td><b>DR9R001</b></td> <td>DR30F4M DR30F4N DR30M4M</td> <td>ø33.8 x 5</td> </tr> </tbody> </table> <p>* Except AR22VG□, Joy stick selectors, buzzers and numerical indicators</p>	Type	Used with	Dimensions, mm	<b>AR9R744</b>	AR22, DR22*	ø29.7 x 4	<b>DR9R001</b>	DR30F4M DR30F4N DR30M4M	ø33.8 x 5
Type	Used with	Dimensions, mm								
<b>AR9R744</b>	AR22, DR22*	ø29.7 x 4								
<b>DR9R001</b>	DR30F4M DR30F4N DR30M4M	ø33.8 x 5								

<p>Description</p> <p>Nut for 30mm dia. types (Resin types are black, metallic types are silver.)</p>  <p>KK2-120A</p>  <p>KK2-121A</p>  <p>KK2-122A</p>  <p>KK2-123A</p>	<p>Type</p> <p><b>AR9R001</b>: Resin, black (standard) <b>AHX088</b>: Metallic, silver</p> <p>Used with: AR30F0R, F5R, FAR, FBR, E0R, E5R, EAR, EBR, E0L, E5L, Q7L DR30D0L, E3L, K0L</p> <p><b>AR9R002</b>: Resin, black (standard) <b>AHX093</b>: Metallic, silver</p> <p>Used with: AR30M0R, M5R, M4R, G0R, G5R, N0R, S□R, V□R, Q2R, V□L, PR, PCR, WR, WCR, JR, JCR, JAR, PL, A□N, A□H</p>
<p>Guard ring for 30mm dia Types</p>  <p>AF94-462</p>  <p>KK04-115A</p>  <p>KK04-113C</p>  <p>KK04-117C</p>  <p>KK04-112B</p>	<p><b>AR9R054-B</b>: Metallic, black Used with: AR30G1R, G6R, G3L, G8L</p> <p><b>AR9R056-B</b>: Metallic, black Used with: AR30G2L, G7L</p> <p><b>AR9R223-B</b>: Metallic, black Used with: AR30M3R, M8R</p> <p><b>AR9R265-B</b>: Metallic, black Used with: AR30B1R</p> <p><b>AR9R266-B</b>: Metallic, black Used with: AR30B2R</p> <p><b>AR9R267-B</b>: Metallic, black Used with: AR30B3R</p> <p><b>AR9R007</b>: Metallic, silver Used with: AR30GSR</p> <p><b>AR9R003</b>: Silver metallic and transparent resin Used with: AR30G4L</p> <p><b>AHX-054</b>: Metallic, silver Used with: AR30G1R, G6R, G3L, G8L</p> <p><b>AHX-055</b>: Metallic, silver Used with: AR30G2L, G7L</p>

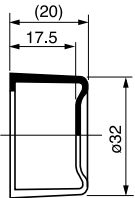



Pushbuttons/Selectors/Pilot Lights  
**AR22/DR22 and AR30/DR30**  
**Accessories**





Description	Type												
<p>Water-tight cap for 22mm dia. types</p>  <p style="text-align: right; margin-right: 10px;">KK2-124A</p>	<p><b>AR9D797-□</b></p> <p>This rubber cap protects the operator and switch mechanism against dust and water. Use this cap in a dusty or moist environment.</p> <p>Used with:  AR22E0L, E5L  AR22E0R, E5R</p> <p>Replace the □ mark by the luminous color code.</p> <table border="1" data-bbox="393 604 643 779"> <thead> <tr> <th>Code</th> <th>Color</th> </tr> </thead> <tbody> <tr> <td>G</td> <td>Green</td> </tr> <tr> <td>R</td> <td>Red</td> </tr> <tr> <td>B</td> <td>Black</td> </tr> <tr> <td>Y</td> <td>Yellow</td> </tr> <tr> <td>Blank</td> <td>Clear (standard)</td> </tr> </tbody> </table> <p>Dimensions, mm:</p> 	Code	Color	G	Green	R	Red	B	Black	Y	Yellow	Blank	Clear (standard)
Code	Color												
G	Green												
R	Red												
B	Black												
Y	Yellow												
Blank	Clear (standard)												
<p>Water-tight cap for 30mm dia. types</p>  <p style="text-align: right; margin-right: 10px;">Y-1559</p>	<p><b>AHX052</b></p> <p>This rubber cap protects the operator and switch mechanism against dust and water. Use this cap in a dusty or moist environment. The only color available is transparent.</p> <p>Used with:  AR30E□R, E□L</p> <p>Dimensions, mm: ø36 x 22.5</p>												

# Pushbuttons/Selectors/Pilot Lights

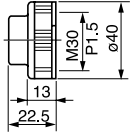
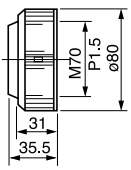
## AR22/DR22 and AR30/DR30

### Accessories

Description	Type																																																																
Dust-proof cap for 30mm dia. types   SC-993   AF89-772   AF94-462   KK2-125A	<table border="1"> <thead> <tr> <th>Type</th> <th>Color</th> <th>Used with</th> <th>Spec.</th> </tr> </thead> <tbody> <tr> <td><b>AHX032</b></td> <td>Red</td> <td>AR30E0R</td> <td>Oil-proof</td> </tr> <tr> <td><b>AHX033</b></td> <td>Green</td> <td></td> <td></td> </tr> <tr> <td><b>AHX034</b></td> <td>Black</td> <td></td> <td></td> </tr> <tr> <td><b>AHX041</b></td> <td>Red</td> <td>AR30F0R</td> <td>Oil-proof</td> </tr> <tr> <td><b>AHX042</b></td> <td>Green</td> <td></td> <td></td> </tr> <tr> <td><b>AHX043</b></td> <td>Black</td> <td></td> <td></td> </tr> <tr> <td><b>AHX157-R</b></td> <td>Red</td> <td>AR30B2R,</td> <td>Oil-proof</td> </tr> <tr> <td><b>AHX157-G</b></td> <td>Green</td> <td>B3R</td> <td></td> </tr> <tr> <td><b>AHX157-B</b></td> <td>Black</td> <td></td> <td></td> </tr> <tr> <td><b>AHX113-R</b></td> <td>Red</td> <td>AR30E0R</td> <td>Weather resistance</td> </tr> <tr> <td><b>AHX113-G</b></td> <td>Green</td> <td></td> <td></td> </tr> <tr> <td><b>AHX113-B</b></td> <td>Black</td> <td></td> <td></td> </tr> <tr> <td><b>AHX111-R</b></td> <td>Red</td> <td>AR30F0R</td> <td>Weather resistance</td> </tr> <tr> <td><b>AHX111-G</b></td> <td>Green</td> <td></td> <td></td> </tr> <tr> <td><b>AHX111-B</b></td> <td>Black</td> <td></td> <td></td> </tr> </tbody> </table> <p>Dimensions, mm:</p> <p>AHX032 to 034, 041 to 043            AHX111, 113</p>  <p>AHX157</p>  <p>Used for sealing the operator from foreign debris such as dust, oil (oil-proof), and water (weather resistance) in environments where the unit is in contact with such elements.</p>	Type	Color	Used with	Spec.	<b>AHX032</b>	Red	AR30E0R	Oil-proof	<b>AHX033</b>	Green			<b>AHX034</b>	Black			<b>AHX041</b>	Red	AR30F0R	Oil-proof	<b>AHX042</b>	Green			<b>AHX043</b>	Black			<b>AHX157-R</b>	Red	AR30B2R,	Oil-proof	<b>AHX157-G</b>	Green	B3R		<b>AHX157-B</b>	Black			<b>AHX113-R</b>	Red	AR30E0R	Weather resistance	<b>AHX113-G</b>	Green			<b>AHX113-B</b>	Black			<b>AHX111-R</b>	Red	AR30F0R	Weather resistance	<b>AHX111-G</b>	Green			<b>AHX111-B</b>	Black		
	Type	Color	Used with	Spec.																																																													
	<b>AHX032</b>	Red	AR30E0R	Oil-proof																																																													
	<b>AHX033</b>	Green																																																															
	<b>AHX034</b>	Black																																																															
	<b>AHX041</b>	Red	AR30F0R	Oil-proof																																																													
	<b>AHX042</b>	Green																																																															
	<b>AHX043</b>	Black																																																															
	<b>AHX157-R</b>	Red	AR30B2R,	Oil-proof																																																													
	<b>AHX157-G</b>	Green	B3R																																																														
	<b>AHX157-B</b>	Black																																																															
	<b>AHX113-R</b>	Red	AR30E0R	Weather resistance																																																													
	<b>AHX113-G</b>	Green																																																															
<b>AHX113-B</b>	Black																																																																
<b>AHX111-R</b>	Red	AR30F0R	Weather resistance																																																														
<b>AHX111-G</b>	Green																																																																
<b>AHX111-B</b>	Black																																																																
Packing	<p><b>AR9Y730:</b>            AR22 and DR22 (Rubber)            Note: Except for joystick selector switches, buzzers</p> <p><b>AHX282:</b>            AR30 and DR30 (Resin-stander)            Note: Except for DR30F4M, F4N, M4M, numerical indicators</p> <p><b>AHX149:</b>            AR30 and DR30 (Rubber)            Note: Except for DR30F4M, F4N, M4M, numerical indicators</p>																																																																

Description	Type												
Terminal cover   AF94-466   KK2-126A	<table border="1"> <thead> <tr> <th>Type</th> <th>Used with</th> <th>Dimensions, mm</th> </tr> </thead> <tbody> <tr> <td><b>AR9Y305</b></td> <td>Contact unit Lamp terminal Transformer unit *1</td> <td>18.4 x 29 x 8.4</td> </tr> <tr> <td><b>DR9Y320</b></td> <td>Pilot lights *2 (without transformer)</td> <td>ø22 x 5.8</td> </tr> <tr> <td><b>DR9Y321</b></td> <td>DR30F4M, F4N, M4M (without transformer)</td> <td>34 sq. x 8.7</td> </tr> </tbody> </table> <p>*1 Applicable up to 220V.            *2 DR22D0L, E3L, K0L, F□M, E3M, E3N, E3P, DR30D0L, E3L, K0L</p> <p>The terminal cover is provided as standard with the applicable types listed above. (Except for joy stick selector switches, numerical indicators, pilot lights with resistors, contact block alone and lamp terminal alone)</p>	Type	Used with	Dimensions, mm	<b>AR9Y305</b>	Contact unit Lamp terminal Transformer unit *1	18.4 x 29 x 8.4	<b>DR9Y320</b>	Pilot lights *2 (without transformer)	ø22 x 5.8	<b>DR9Y321</b>	DR30F4M, F4N, M4M (without transformer)	34 sq. x 8.7
	Type	Used with	Dimensions, mm										
	<b>AR9Y305</b>	Contact unit Lamp terminal Transformer unit *1	18.4 x 29 x 8.4										
<b>DR9Y320</b>	Pilot lights *2 (without transformer)	ø22 x 5.8											
<b>DR9Y321</b>	DR30F4M, F4N, M4M (without transformer)	34 sq. x 8.7											
Terminal cover   AHX305 SG-842   AHX426 AF92-339   AHX376 SG-5	<table border="1"> <thead> <tr> <th>Type</th> <th>Used with</th> <th>Dimensions, mm</th> </tr> </thead> <tbody> <tr> <td><b>AHX305</b></td> <td>Buzzers (without transformer)</td> <td>23.5 x 27.5 x 16</td> </tr> <tr> <td><b>AHX426</b></td> <td>DR30D1L (without transformer)</td> <td>27.5 x 31 x 8</td> </tr> <tr> <td><b>AHX376</b></td> <td>DR30D1L (with transformer) Buzzers (B0 type)</td> <td>13 x 29 x 6.5</td> </tr> </tbody> </table> <p>With transformer *            With short-body transformer            With resistor unit</p> <p>* 230V and over</p> <p>The terminal cover is provided as standard with the applicable types listed above.</p>	Type	Used with	Dimensions, mm	<b>AHX305</b>	Buzzers (without transformer)	23.5 x 27.5 x 16	<b>AHX426</b>	DR30D1L (without transformer)	27.5 x 31 x 8	<b>AHX376</b>	DR30D1L (with transformer) Buzzers (B0 type)	13 x 29 x 6.5
Type	Used with	Dimensions, mm											
<b>AHX305</b>	Buzzers (without transformer)	23.5 x 27.5 x 16											
<b>AHX426</b>	DR30D1L (without transformer)	27.5 x 31 x 8											
<b>AHX376</b>	DR30D1L (with transformer) Buzzers (B0 type)	13 x 29 x 6.5											



# Pushbuttons/Selectors/Pilot Lights/Buzzers AR22/DR22 and AR30/DR30 Special products

## Products equipped with contact protection cover

### ■ Features

A silicon rubber cover is provided for the contact block to keep out foreign matter such as dust, etc.  
Other ratings and specifications are the same as those of the standard type.

### ■ Type

**AR22 □ Z8**

**AR30 □ Z8**

Specify "Z8" at the end of the type number of the standard type.

### ■ Dimensions

The only thing different from the standard product is the addition of a 1-mm thick silicon rubber cover around the contact block.

### ■ Applicable types

Type	Contact arrangement	Remarks
• Pushbuttons *1 • Emergency stop pushbuttons *2 • Selectors	1NO+1NC, 2NO*4, 2NC	For use with a 1-step contact
	1NO+3NC, 2NO+2NC, 3NO+1NC, 4NO*4, 4NC	For use with a 2-step contact
• Illuminated pushbuttons *3 (without transformer)	1NO*5, 1NC	For use with a 1-step contact
• Emergency stop illuminated pushbuttons*2 (without transformer)	1NO+2NC, 2NO+1NC, 3NO*5, 3NC	For use with a 2-step contact
• Illuminated selectors (without transformer)		

Notes: \*1 Except for AR30B0R, B1R, B2R, B3R, N0R, and GPR.

\*2 Except for unibody (VG types)

\*3 Except for AR30Q7L

\*4 Except for emergency stop pushbutton switch

\*5 Except for emergency stop illuminated pushbutton switch

## Resisting water-soluble cutting oils and heat

### ■ Features

Safer operation in environments exposed to water-miscible cutting fluids, machining oils, lubricating oils, cleaning oils and high humidity (up to 95%) is made possible by using materials that protect against rust and corrosion of components.  
Other ratings and specifications are the same as those of the standard type.

### ■ Type

**AR22 □ Z9, DR22 □ Z9**

**AR30 □ Z9, DR30 □ Z9**

Specify "Z9" at the end of the type number of the standard type.

### ■ Dimensions

Same as those of the standard type

### ■ Applicable types

• AR22, DR22 series

AR 22 (Except for joy stick selectors and VG types)

DR22 (Except for pilot lights with resistor unit, buzzers, and numerical indicators)

• AR30, DR30 series

AR30 (Except for Q7L types and joy stick selectors)

DR30 (Except for D1L, F4M, F4N, M4M types, pilot lights with resistor/resistor unit, buzzers, and numerical indicators)

# Pushbuttons/Selectors/Pilot Lights/Buzzers AR22/DR22 and AR30/DR30 Special products

## Meeting IP2X finger protection standards

### ■ Features

Conforms to EN standard EN60204-1 (protecting against electric shock). The terminal has IEC60529 degree of protection; IP2X finger protection secured (a mock human finger used in testing did not come into contact with charged parts). The contact block and lamp terminal can be easily mounted or removed with the terminal cover mounted.

### ■ Type

AR22 □ ZB, DR22 □ ZB

AR30 □ ZB, DR30 □ ZB

Specify "ZB" at the end of the type number of the standard type.

### ■ Accessories

- Contact block (plus terminal cover)  
NO contact: AR9B290-D  
NC contact: AR9B291-D
- Transformer unit (plus terminal cover)  
AR9T511-□ D

### ■ Ratings and specifications

- Protection degree: IP2X
- Terminal screw: M3.5  
Wiring can be done with a solid wire or fork shaped crimp terminal.

Note: Ring-type crimp terminals cannot be used.

- Other ratings and specifications are the same as those of the standard type.

### ■ Applicable types

- AR22, DR22 series  
AR22 (except for joy stick selectors)  
DR22: Without transformer, with transformer (except for short-body types, buzzers and numerical indicators)
- AR30, DR30 series  
AR30 (except for joy stick selectors)  
DR30: Without transformer, with transformer (except for D1L, short-body types, F4M, F4N, M4M types, buzzers and numerical indicators)

Note: The terminal of the standard type VG has IP2X protection.

## ■ Dimensions, mm

AR22/Pushbutton switches

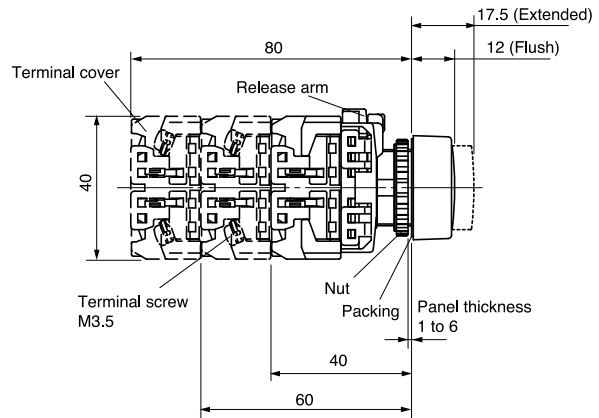

DR22/Without transformer

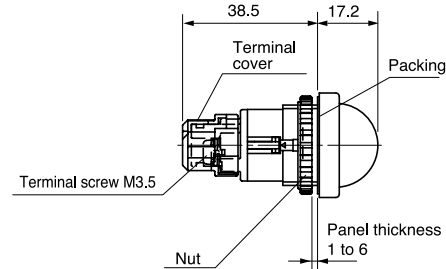

DR22/With transformer

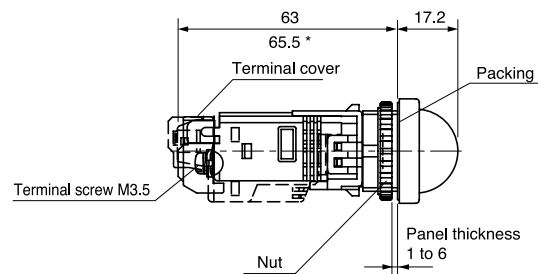

Note: \* Except for the types 110V AC, 127V AC and 220V AC.

# Pushbuttons/Selectors/Pilot Lights/Buzzers AR22/DR22 and AR30/DR30 Special products

## Metal nut (chrome plated) types

### ■ Features

The nut is a metallic ring (chrome plated).  
Other ratings and specifications are the same as those of the standard model.

### ■ Type

**AR30 □ ZM**

**DR30 □ ZM**

Specify "ZM" at the end of the type number of the standard type.

### ■ Dimensions, mm

Same as those of the standard types.

### ■ Applicable types

• AR30, DR30 series

AR30 (except for G4L, G9L, GSR\*<sup>1</sup>, GPR\*<sup>1</sup>, and B0R\*<sup>1</sup> types)

DR30 with round bezel (except for IP54 buzzer type B8)\*<sup>2</sup>

Notes: \*<sup>1</sup> Standard type is a metallic ring (chrome plated).

\*<sup>2</sup> The nut of types DR30B0, B5 and B6 buzzers are resin (chrome plated).

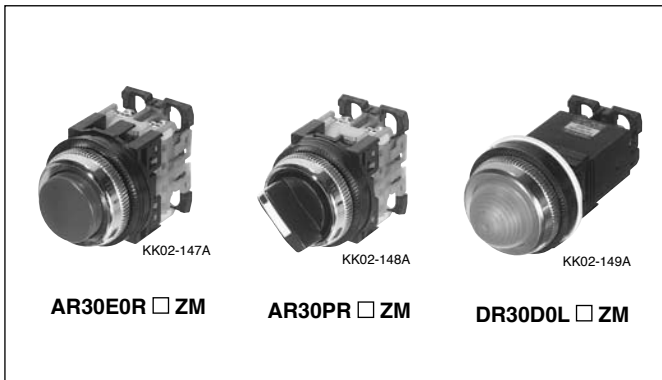

## Resisting sulfuration gas

### ■ Features

These products can be used in environments having a concentration of hydrogen sulfide gas of 0.5 ppm or less. The metallic parts have been subjected to an anti-corrosion treatment (see note). The contacts of the AR series are gold plated.

Note: The body is made of resin and cannot be used with gases that affect resins (plastics).

### ■ Type

**AR22 □ Z4, DR22 □ Z4**

**AR30 □ Z4, DR30 □ Z4**

Specify "Z4" at the end of the type number of the standard type.

### ■ Notes on use

- This product is resistant to light corrosive gas exposure.
- Other measures, such as covering the entire switch with a box, and the degree of protection of the panel should be taken into consideration.

### ■ Ratings and specifications

Hydrogen sulfide gas concentration of 0.5 ppm max.

Ambient storage temperature: 8 to 37°C

Humidity: 62 to 81%

Other ratings and specifications are the same as those of the standard type.

### ■ Dimensions, mm

Same as those of the standard types.

### ■ Applicable types

• AR22, DR22 series

AR22 (except for Joy stick selectors and VG type)

DR22 (except for pilot lights with resistor unit, buzzers, and numerical indicators)

• AR30, DR30 series

AR30 (except for Joy stick selectors)

DR30 (except for F4M, F4N, M4M types, pilot lights with resistor/resistor unit, buzzers and numerical indicators)

# Pushbuttons/Selectors/Pilot Lights/Buzzers

## AR22 and DR22

### Mass

#### ■ Mass, gram

#### ● Illuminated pushbuttons

Type	Without transformer			With transformer *	
	1NO (1NC)	2NO (2NC) (1NO+1NC)	2NO+2NC	1NO (1NC)	2NO (2NC) (1NO+1NC)
AR22F0L	39	48	67	85	94
F5L	39	48	—	85	94
F0M, F0P	40	49	68	86	95
F5M, F5P	40	49	—	86	95
E0L	41	50	69	87	96
E5L	41	50	—	87	96
E0M, E0P, M4L, G1L, G2L, G4L	42	51	70	88	97
E5M, E5P, M9L, G6L, G7L, G9L	42	51	—	88	97
M4P	43	52	71	89	98
M0L	44	53	72	90	99
M5L	44	53	—	90	99
V5L	48	57	—	94	103

Note: \* 230V and over : +17grams

#### ● Pushbuttons

Type	1NO (1NC)	2NO (2NC) (1NO+1NC)	2NO+2NC
AR22F0R, FAR, F5R, FBR	27	36	55
E0R, EAR, F0S, F0Y, G0R	28	37	56
E5R, EBR, F5S, F5Y, G5R	29	38	57
E0S, E0Y, M4R, G2R	31	40	59
E5S, E5Y, M9R, G7R	—	43	62
M0R, M5R	44	53	72
S1R, S2R, S3R, S6R	49	58	77
M3R, M8R	—	—	—
V5R	—	—	—

#### ● Emergency stop pushbuttons

Type	1NC	2NC (1NO+1NC)	2NO+2NC
AR22VSR	34	43	62
V0R, V4R	36	45	64
Q2R	36	45	—
V2R	38	47	66
V7R	61	70	89
VGE	61	65	—

#### ● Emergency stop illuminated pushbuttons

Type	Without transformer		With transformer *	
	1NC	2NC (1NO+1NC)	1NC	2NC (1NO+1NC)
AR22VSL, VDL	48	57	94	103
V0L	49	58	95	104
VAL	50	59	96	105
V2L	51	60	97	106
VGF	66	70	—	—

Note: \* 230V and over : +17grams

■ Mass, gram

● Pilot lights

Type	Without transformer		With transformer		With resistor unit
	Standard	Short-body	Standard *	Short-body	
DR22D0L, K0L	18	23	70	68	32
E3L, E3P, F3M, F4M	19	24	71	69	33
F5M	20	25	72	70	34
E3M	21	26	73	71	35
E3N	23	28	75	73	37

Note: \* 230V and over : +17grams

● Selector switches

Type	1NO	2NO	2NO+2NC
	(1NC)	(2NC) (1NO+1NC)	
AR22PR	30	39	58
PCR	–	39	58
WR	31	40	59
WCR	–	40	59
RR, PY, WY	32	41	60
RCR, PCY, WCY	–	41	60
RY	33	42	61
RCY	–	42	61
JR, JAR	56	65	83
JCR	–	65	83
JY	57	66	84
JCY	–	66	84

● Illuminated selector switches

Type	Without transformer			With transformer *	
	1NO (1NC)	2NO (2NC) (1NO+1NC)	2NO+2NC	1NO (1NC)	2NO (2NC) (1NO+1NC)
AR22PL	42	51	70	88	97
PP	43	52	71	89	98

Note: \* 230V and over : +17grams

● Joy stick selector switches

• Screw terminal types

Type	1NO x2	(1NO+1NC) x2	1NO x4	(1NO+1NC) x4
AR22A2N, A7N	89	99	116	136
A0N, A5N	99	109	126	146
A1N, A6N	112	122	139	159

• Solder/tab terminal types

Type	(1NO+1NC) x2	(2NO+2NC) x2	(1NO+1NC) x4	(2NO+2NC) x4
AR22A2H, A7H	72	75	82	88
A0H, A5H	82	85	92	98
A1H, A6H	95	98	105	111

● Buzzers

Type	Without transformer	With transformer	With resistor unit
DR22B5	50	105	52
B8	53	108	55
B3	66	121	–

● Numerical indicators

Type	Solder	Solder (with connector)	With right angle connector
DR22N1	53	62	55
N2	67	76	69

# Pushbuttons/Selectors/Pilot Lights/Buzzers

## AR30 and DR30

### Mass

■ Mass, gram  
● Illuminated pushbuttons

Type	Without transformer			With transformer *	
	1NO (1NC)	2NO (2NC) (1NO+1NC)	2NO+2NC	1NO (1NC)	2NO (2NC) (1NO+1NC)
AR30E0L	49	58	77	95	104
E5L	49	58	—	95	104
G4L	50	59	78	96	105
G9L	50	59	—	96	105
V5L	56	65	—	102	111
G2L	66	75	94	112	121
G7L	66	75	—	112	121
G3L	72	81	100	118	127
G8L	72	81	—	118	127
Q7L	—	159	—	—	205

Note: \* 230V and over : +17grams

● Pushbuttons

Type	1NO (1NC)	2NO (2NC) (1NO+1NC)	2NO+2NC
AR30F0R, FAR, F5R, FBR	36	45	64
E0R, EAR, G0R, E5R, EBR, G5R	37	46	65
M4R	38	47	66
M0R, M5R	40	49	68
V5R	42	51	70
S1R, S2R, S3R, S6R	—	53	72
FVR	54	63	82
G1R, G6R	59	68	87
N0R	96	105	124
GPR	116	125	144
GSR, B0R	123	132	151
M3R, M8R	126	135	154
B1R	241	250	269
B3R	279	288	307
B2R	291	300	319

● Emergency stop pushbuttons

Type	1NC	2NC (1NO+1NC)	2NO+2NC
AR30V0R	43	52	71
Q2R	45	54	—
V2R	46	55	74
V1R	60	69	88

● Emergency stop illuminated pushbuttons

Type	Without transformer		With transformer *	
	1NC	2NC (1NO+1NC)	1NC	2NC (1NO+1NC)
AR30V0L	57	66	103	112
V2L	59	68	105	114

Note: \* 230V and over : +17grams

■ **Mass, gram**

● **Pilot lights**

• Without transformer type, With transformer type, With resistor unit type

Type	Without transformer Standard	With transformer Standard * <sup>1</sup>	Short-body	With resistor unit
DR30D0L, K0L	28	80	78	42
E3L	29	81	79	43
F4M * <sup>2</sup>	32 (30)	84 (82)	—	46
F4N * <sup>2</sup>	34 (30)	86 (82)	—	48
M4M * <sup>2</sup>	37 (32)	88 (84)	—	50
D1L	94	164	—	111

Notes: \*<sup>1</sup> 230V and over : +17grams

\*<sup>2</sup> ( ) : Incandescent lamp

• With resistor type

Type	50V DC	110V DC 220V DC
DR30D0L, K0L (LED)	103	103
D0L, K0L (incandescent )	107	179

● **Selector switches**

Type	1NO (1NC)	2NO (2NC) (1NO+1NC)	2NO+2NC
AR30PR, WR	41	50	69
PCR, WCR	—	50	69
JR, JAR	67	76	94
JCR	—	76	94

● **Illuminated selector switches**

Type	Without transformer			With transformer *	
	1NO (1NC)	2NO (2NC) (1NO+1NC)	2NO+2NC	1NO (1NC)	2NO (2NC) (1NO+1NC)
AR30PL	52	61	80	98	107

Note: \* 230V and over : +17grams

● **Joy stick selector switches**

• Screw terminal type

Type	1NO x2	(1NO+1NC) x2	1NO x4	(1NO+1NC) x4
AR30A2N, A7N	100	110	127	147
A0N, A5N	110	120	137	157
A1N, A6N	124	134	151	171

• Solder/tab terminal type

Type	(1NO+1NC) x2	(2NO+2NC) x2	(1NO+1NC) x4	(2NO+2NC) x4
AR30A2H, A7H	83	86	93	99
A0H, A5H	93	96	103	109
A1H, A6H	107	110	117	123

● **Buzzers**

Type	Without transformer	With transformer	With resistor unit
DR30B5, B6	47	102	49 (Except B6)
B8	48	103	50
B0	86	—	—

# Pushbuttons/Selectors/Pilot Lights/Buzzers

## AH164, AH165 and AH165-2

### General information

#### ■ Features

##### Design basis

The 16mm dia. series of compact size pushbuttons are 'finger-size', and consequently take up little panel space. AH165-2 series operators are about twice as large as the AH164 and AH165 series operators for easier operation. With many types of operator available, the most suitable switch can be identified by color, shape and legend, and have a smooth, quality "snap-action". In spite of their small size they have a highly reliable mechanism, and are eminently suited for solid state and other electronic circuits. AH164, AH165 and AH165-2 series contact block holders can easily be removed manually. Moreover, the contact block can be easily attached or detached without using any special tools, thus facilitating addition or replacement of contact.

##### Selector switches

Selector switches can also be supplied in either knob-handle operated or key operated types.

##### Strong construction

The operator and contact blocks are molded from an excellent thermal resistance resin and can withstand the heat at the time of soldering. Since these pushbuttons are manufactured to industrial standards they can withstand vibration or shock thus eliminating lamp failure due to such causes as loose bases. With regard to the degree of protection, standard types which met the requirements of IP40 of Pub. No. 529, IEC Standards, and oil tight types which meet the requirements of IP65 of the said, are available. This permits the application to various fields, from machine tools to OA (Office Automation) facilities.

##### Quality feel tough

Both the operator and contact block are precisely engineered. There is no fear of the switch malfunction even after long use and it continues to operate smoothly for its service life of about 1,000,000 operations.

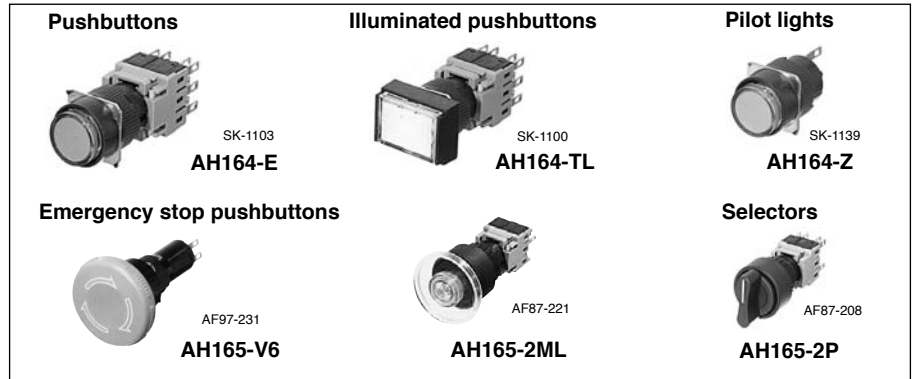

##### Easy color change

Color lenses fit over the inner button. The lens can easily be removed using a small screwdriver

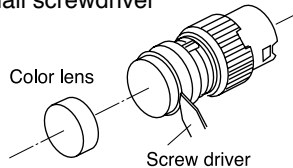

Note: The luminous color of LEDs and neon illumination types varies with the body color of the product.

##### Visible inscription

Button legends are printed on legend sheet, which is stuck to the legend plate on the inner button. The lettering is back lit by the switch lamp and the inscription is highly visible through the color lens. Contact FUJI for your lettering requirements.

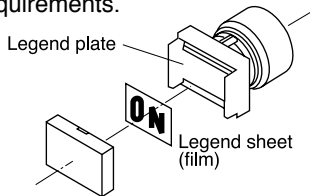

##### Excellent switch reliability

The switch uses a snap-action mechanism. The pushbuttons are available with either momentary or alternative actions. The snap-action switch has a double break movement which operates independently of the speed of switching. The contacts are made from gold-flashed silver. High contact reliability of 1mA at 5V AC/DC is assured. Contact blocks are available in 1NO+1NC to 3NO+3NC arrangement.

##### Large terminals

Solder/tab terminal is provided as standard. Wire-wrap terminal is available on request.

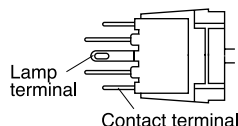

##### Safety

FUJI's original Trigger Action mechanism is used in the emergency stop pushbuttons. They are suitable for emergency stop and safety. This mechanism prevents the contacts from moving until the button is pushed and locked.

- Provided with a trigger action mechanism conforming to EN418.
- Provided with direct opening action (approved by TÜV) conforming to EN60947-5-1 and EN60947-5-5.

##### Alternate action

In the case of alternate action when the button is depressed the contacts are maintained and remain so even if the finger is removed. The button will not return to its free position. In order to remove the lock, the button must be given a second pressure before the button will return to its free position. This makes it most suitable as the switch for a power source.

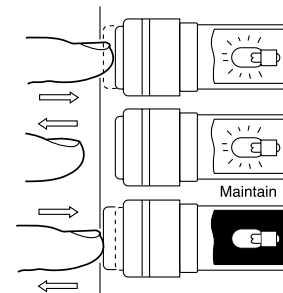

##### Pushbutton with finger guards

Finger guards are provided for square or rectangular type pushbuttons (SF, TF, SL and TL types) in order to prevent operational error of adjacent buttons.

##### Approvals















# Pushbuttons/Selectors/Pilot Lights/Buzzers

## AH164, AH165 and AH165-2

### Quick reference guide





















#### AH164 (standard) / AH165 (oil-tight)

##### ■ Illuminated pushbutton switches

Operator	Type	Operator	Type	Operator	Type
Extended round head	<b>AH164-L, L5</b> <b>AH165-L, L5</b>  SK-1103	Flush square head	<b>AH164-SL, SL5</b> <b>AH165-SL, SL5</b>  SK-1102	Flush rectangular head	<b>AH164-TL, TL5</b> <b>AH165-TL, TL5</b>  SK-1100
					
Flush rectangular head with guard	<b>AH164-TGL, TGL5</b> <b>AH165-TGL, TGL5</b>  SK-1101	Flush square head with guard	<b>AH164-SGL, SGL5</b> <b>AH165-SGL, SGL5</b>  AF90-301		
					

Note: Spot LED and red/green LED types: Not approved standard

##### ■ Pushbutton switches

Operator	Type	Operator	Type	Operator	Type
Extended round head	<b>AH164-E, E5</b> <b>AH165-E, E5</b>  SK-1103	Mushroom head	<b>AH164-M, M5</b> <b>AH165-M, M5</b>  SK-1136	Flush square head	<b>AH164-SF, SF5</b> <b>AH165-SF, SF5</b>  SK-1102
					
Flush rectangular head	<b>AH164-TF, TF5</b> <b>AH165-TF, TF5</b>  SK-1100	Flush rectangular head with guard	<b>AH164-TGF, TGF5</b> <b>AH165-TGF, TGF5</b>  SK-1101	Flush square head with guard	<b>AH164-SGF, SGF5</b> <b>AH165-SGF, SGF5</b>  AF90-301
					
Convex square head	<b>AH164-SM, SM5</b> <b>AH165-SM, SM5</b>  SK-1134	Convex rectangular head	<b>AH164-TM, TM5</b> <b>AH165-TM, TM5</b>  SK-1135	Push-lock, turn-reset (32mm dia.) ⊖ (Direct opening action)	<b>AH165-VR</b>  AF91-584
					
Push-lock, turn-reset (40mm dia.) ⊖ (Direct opening action)	<b>AH165-V1R</b>  AF91-583				
					

##### ■ Emergency stop pushbutton switches ⊖ (Direct opening action), conform to EN418







Operator	Type	Operator	Type
Push-lock, turn-reset (32mm dia.)	<b>AH165-V5R</b>  AF97-232	Push-lock, turn-reset (40mm dia.)	<b>AH165-V6R</b>  AF97-231
			

# Pushbuttons/Selectors/Pilot Lights/Buzzers





## AH164, AH165 and AH165-2

### Quick reference guide





#### ■ Selector switches

Operator	Type	Operator	Type	Operator	Type
Knob with rectangular bezel	<b>AH164-P</b> <b>AH165-P</b>  SK-1099	Knob with square bezel	<b>AH164-SP</b> <b>AH165-SP</b>  SK-1133	Key with rectangular bezel	<b>AH164-J</b> <b>AH165-J</b>  SK-1098
Key with square bezel	<b>AH164-SJ</b> <b>AH165-SJ</b>  SK-1132	Key with rectangular bezel ⊖ (Direct opening action)	<b>AH165-JM</b>  AF95-57	Key ⊖ (Direct opening action)	<b>AH165-RJM</b>  AF99-320

#### ■ Pilot lights

Lens	Type	Lens	Type	Lens	Type
Extended round	<b>AH164-Z</b> <b>AH165-Z</b>  SK-1139	Flush square	<b>AH164-ZS</b> <b>AH165-ZS</b>  SK-1138	Flush rectangular	<b>AH164-ZT</b> <b>AH165-ZT</b>  SK-1137
Dome	<b>AH165-ZM</b>  AF87-45				

#### ■ Buzzers



Sound	Type	Sound	Type	Sound	Type
Standard	<b>AH164-TX</b>  AF87-317	Loud sound	<b>AH164-TX1</b>  AF87-44	Loud sound with volume control	<b>AH164-TX2B</b>  AF93-297
Standard sound with volume control (IP54)	<b>AH165-X</b>  AF96-243				

# Pushbuttons/Selectors/Pilot Lights/Buzzers

## AH164, AH165 and AH165-2

### Quick reference guide

#### ■ Numerical indicators

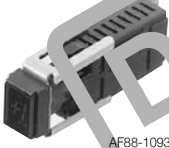
Display	Type	Display	Type	Display	Type
Without decimal decoder	<b>AH164-TS</b> <b>AH165-TS</b>  SP-165	With decimal decoder (5, 12, 15V)	<b>AH164-TC</b> <b>AH165-TC</b>  AF87-315	With decimal decoder (24V)	<b>AH164-TC4□E</b> <b>AH165-TC4□E</b>  AF89-948
With sign decoder (±1 display)	<b>AH164-TC4□E-1</b> <b>AH165-TC4□E-1</b>  AF88-1093				

#### AH165-2 (oil-tight)

#### ■ Illuminated pushbutton switches

Operator	Type	Operator	Type	Operator	Type
Flush round head	<b>AH165-2FL, 2FL5</b>  AF87-211	Extended round head	<b>AH165-2EL, 2EL5</b>  AF87-210	Mushroom head	<b>AH165-2ML</b>  AF87-221
Mushroom head with square bezel	<b>AH165-2YML</b>  AF87-220	Flush square head	<b>AH165-2SFL, 2SFL5</b>  AF87-201	Extended square head	<b>AH165-2SEL, 2SEL5</b>  AF87-200
Concave square head	<b>AH165-2SCL, 2SCL5</b>  AF87-199	Push-lock, turn-reset	<b>AH165-2VL</b>  AF87-219	Push-lock, turn-reset with square bezel	<b>AH165-2YVL</b>  AF87-218

# Pushbuttons/Selectors/Pilot Lights/Buzzers







## AH164, AH165 and AH165-2

### Quick reference guide

#### ■ Pushbutton switches

Operator	Type	Operator	Type	Operator	Type
Flush round head	<b>AH165-2F, 2F5</b>  AF87-211	Extended round head	<b>AH165-2E, 2E5</b>  AF87-210	Mushroom head	<b>AH165-2M</b>  AF87-215
Mushroom head with square bezel	<b>AH165-2YM</b>  AF87-214	Flush square head	<b>AH165-2SF, 2SF5</b>  AF87-201	Concave square head	<b>AH165-2SCE, 2SCE5</b>  AF87-199
Extended square head	<b>AH165-2SE, 2SE5</b>  AF87-200	With selector ring	<b>AH165-2S2</b>  AF87-207	With selector ring with square bezel	<b>AH165-2YS2</b>  AF87-206
Push-lock, turn-reset	<b>AH165-2V</b>  AF87-217	Push-lock, turn-reset with square bezel	<b>AH165-2YV</b>  AF87-216		

#### ■ Selector switches

Operator	Type	Operator	Type	Operator	Type
Knob	<b>AH165-2P</b>  AF87-208	Knob with square bezel	<b>AH165-2YP</b>  AF87-202	Key	<b>AH165-2J</b>  AF87-223
Key with square bezel	<b>AH165-2YJ</b>  AF87-222	Lever	<b>AH165-2H</b>  AF87-209	Lever with square bezel	<b>AH165-2SH</b>  AF87-203

#### ■ Illuminated selector switches





Operator	Type
Knob	<b>AH165-2PL</b>  AF87-607

# Pushbuttons/Selectors/Pilot Lights/Buzzers

## AH164, AH165 and AH165-2

### Quick reference guide

#### ■ Pilot lights

Lens	Type	Lens	Type	Lens	Type
Flush round	<b>AH165-2Z</b>  AF87-213	Extended round	<b>AH165-2ZE</b>  AF87-212	Flush square	<b>AH165-2SZ</b>  AF87-205
Extended square	<b>AH165-2SZE</b>  AF87-204				



# Pushbuttons/Selectors/Pilot Lights/Buzzers

## AH164 and AH165

### Part number system

#### ■ Part number system

##### Selector switches

**AH165 - J 2 B 11 A - W**  
 ① ② ③ ④ ⑤ ⑥ ⑦

##### ① Product category

AH164: Standard (IP40)

AH165: Oil-tight (IP65)

##### ② Operator

• 2-position, 3-position (operating angle 90°)

SP: Knob with square bezel

P: Knob with rectangular bezel

SJ: Key with square bezel

J: Key with rectangular bezel

JM: Key with rectangular bezel (Direct opening action) \*

RJM: Key (Direct opening action) \*

Note: \* AH165 types (2-position) only

• 3-position (operating angle 45°)

SPK: Knob with square bezel

PK: Knob with rectangular bezel

SJK: Key with square bezel

JK: Key with rectangular bezel

##### ③ Operation

2: 2-position, maintained

0: 2-position, spring return\*

3: 3-position, maintained

6: 3-position, spring/manual return (Left to center)

7: 3-position, spring/manual return (Right to center)

1: 3-position, spring return

Note: \* Except for JM and RJM types

##### ④ Color of knob or key removable position

• Color of knob

B: Black

• Key removable position

Code	2-position		3-position (operating angle 90°)				3-position (operating angle 45°)			
	2	0	1	3	6	7	1	3	6	7
A	⊖	⊖	—	⊖	—	⊖	—	⊖	—	⊖
B	⊗	—	—	⊖	—	—	—	⊗	—	—
C	—	—	—	⊕	—	—	—	⊗	—	—
D	⊗	—	—	⊕	—	—	—	⊗	—	—
E	—	—	↑	—	—	—	↑	—	—	—
F	—	—	—	—	—	—	—	⊗	—	—
G	—	—	—	—	—	—	—	⊗	—	⊗

##### ⑤ Contact arrangement

11: 1NO+1NC

22: 2NO+2NC

33: 3NO+3NC\*

Note: \* Except for JM and RJM types.

##### ⑥ Key type No.

A (standard), B, C, D, E, F

##### ⑦ Terminal

Blank: Solder/tab

W: Wire-warp

Note: JM, RJM types: Solder/tab terminal only

##### Buzzers

**AH164 - T X B E**  
 ① ② ③ ④

##### ① Product category

AH164: Standard (IP00)

AH165: Splash-proof (IP54)

##### ② Sound

TX: Standard (AH164)

TX1: Loud sound (AH164)

TX2: Loud sound with volume control (AH164)

X: Standard sound with volume control (AH165)

##### ③ Color of head

B: Black

##### ④ Operating voltage

AAC: 6V AC\*2

ADC: 6V DC\*2

A: 6V AC/DC\*1

E: 12 to 24V AC/DC

F: 35 to 48V AC/DC

Notes: \*1 Except for TX and TX1 types

\*2 Except for TX2 and X types

# Pushbuttons/Selectors/Pilot Lights/Buzzers

## AH164 and AH165

### Ratings and specifications

#### ■ Standards approved

UL508	File No. E44592
CSA C22.2 No.14	File No. LR20479 (except for AH165-ZM) File No. LR84365 (for AH165-ZM)
TÜV: EN60947-5-1	Pushbutton (except for AH165-V, V1), Illuminated pushbutton: R9250087  Pushbutton (for AH165-V, V1): J9551059 Selector (except for AH165-JM, RJM): R9250088 Selector (for AH165-JM, RJM): J9551059 Pilot lights: R9250089 Buzzer: J9950092 (for AH164-TX2, AH165-X)
TÜV: EN60947-5-1 EN60947-5-5	Emergency stop pushbutton: R9950093

#### ■ Specifications (Indoor use)

•Pushbutton switches, illuminated pushbutton switches  
selector switches, pilot lights

Item	AH164	AH165
Rated insulation voltage	250V AC/DC	
Ambient temperature (no condensation or no icing)	-20 to +70°C *1	-10 to +70°C *2
Humidity	45 to 85%RH (at -5 to +40°C), no condensation or no icing	
Durability (operations)	Mechanical	Pushbutton switch Momentary action: 1 million Alternate action: 250,000 Push-lock, turn-reset: 100,000 Selector switch: 250,000 *3
		Electrical 100,000 (220V AC 0.7A)
Dielectric strength	2000V AC, 1 minute (Between lamp and contact terminals: 1500V AC, 1 minute)	
Conditional short-circuit current	1000A	
Short-circuit protective device	Fuse 1A *4	
Pollution degree	3	
Vibration	Resonance: 10 to 55Hz, double amplitude 0.1mm *5 Constant: 16.7Hz, double amplitude 3mm	
Shock	Malfunction durability: 100m/s <sup>2</sup> *6 Mechanical durability: 500m/s <sup>2</sup>	
Operating frequency	1200 operation/hour (on-load factor: 40%)	
Insulation resistance	100MΩ or more (500V DC megger)	
Degree of protection	IP40	IP65

Notes: \*1 For illuminated pushbutton switch and pilot light: -20 to +55°C

\*2 For illuminated pushbutton switch and pilot light: -10 to +55°C

\*3 Key insertion/removal durability for selector switch key types: 10,000

\*4 AH165-V, V1, JM, RJM, V5, V6 types: Fuse 5A

\*5 Emergency stop type: 10 to 500Hz, double amplitude 0.7mm (acceleration 50m/s<sup>2</sup>), according to the test condition of EN60947-5-5 (1998)

\*6 Emergency stop type: 150m/s<sup>2</sup>

#### •Buzzers

Item	AH164-TX	AH164-TX1
Rated insulation voltage	60V AC/DC	
Operating voltage	6V AC, 6V DC, 12 to 24V AC/DC 35 to 48V AC/DC	
Sound level	80dB (0.1m) 60dB(1m)	90dB (0.1m) 70dB(1m)
Durability	1000h	
Frequency	2 ±0.5kHz	2.4 to 3.3kHz
Intermittent cycle	Approx. 170 cycle/minute	
Current consumption	7mA(24, 48V DC) 15mA(6V DC) 20mA (6, 24V AC) 30mA (48V AC)	15mA (24, 48V DC) 25mA (6V DC) 30mA (24V AC) 40mA (48V AC) 50mA (6V AC)
Dielectric strength	1000V AC, 1 minute	
Insulation resistance	100MΩ or more (500V DC megger)	
Ambient temperature	-20 to +60°C (no condensation or no icing)	
Humidity	45 to 85%RH (at -5 to +40°C)	
Operator protection	IP00	

Item	AH164-TX2	AH165-X
Rated insulation voltage	60V AC/DC	
Operating voltage	6V AC/DC, 12 to 24V AC/DC 35 to 48V AC/DC	
Sound level	70dB to 90dB (0.1m) 50dB to 70dB (1m)	60dB to 80dB (0.1m) 40dB to 60dB (1m)
Durability	1000h	
Frequency	2 ±0.5kHz	2.4 to 3.3kHz
Intermittent cycle	Approx. 170 cycle/minute	
Current consumption	30mA (6V DC) 20mA (24, 48V DC) 40mA (6, 24, 48V AC)	
Dielectric strength	1000V AC, 1 minute	
Insulation resistance	100MΩ or more (500V DC megger)	
Ambient temperature	-20 to +60°C (no condensation or no icing)	
Humidity	45 to 85%RH (at -5 to +40°C)	
Degree of protection	IP00	IP54



# Pushbuttons/Selectors/Pilot Lights/Buzzers AH164 and AH165 Ratings and specifications

## ■ Contact ratings

### •UL/CSA standards

Rated thermal current	Rated operational voltage	Maximum current	
		AC (Res. load)	DC (Res. load)
5A	24V 125V 250V	– – 5.0A	1.0A 0.2A –

### •EN standards (TÜV approved)

Rated thermal current	Rated operational voltage	Rated operational current				
		AC 15 (Ind. load)	AC 13 (Ind. load)	AC 12 (Res. load)	DC 13 (Ind. load)	DC 12 (Res. load)
5A	24V 100 to 120V 100 to 125V 200 to 240V	– 0.3A – 0.3A	– 1.0A – 0.7A	– 1.5A – 1.0A	0.7A – 0.15A –	1.0A – 0.2A –

## ■ Lamp ratings

Rated operational voltage	Consumption		
	LED DC	Incandescent AC/DC	Neon AC
5V	14mA (Yellow: 28mA)	0.45W (6V)	–
6V	14mA (Yellow: 28mA)	–	–
12V	14mA	0.55W (14V)	–
24V	14mA	0.55W (28V)	–
110V	–	–	0.19VA
120V	–	–	0.21VA
220V	–	–	0.38VA
240V	–	–	0.42VA

- Notes:
- With transformer (LED): 1.5VA/110, 220V
  - With transformer (Incandescent): 2VA/110, 220V
  - For the incandescent lamps, the values in parentheses indicate the rated voltage of the lamps.



## ■ Contact reliability

FUJI has confirmed that the unit can be used in 1mA circuit conditions at 5V AC or DC. The operable range may vary depending on the ambient conditions and type of load.

# Illuminated Pushbuttons



## AH164 and AH165

### ■ Illuminated pushbutton switches/without transformer

Operator	Lamp	Voltage	Contact	Momentary action		Alternate action	
				AH164 type	AH165 (Oil-tight) type	AH164 type	AH165 (Oil-tight) type
 SK-1103	Flat LED	24V DC	1NO+1NC 2NO+2NC 3NO+3NC	AH164-L□11E3	AH165-L□11E3	AH164-L5□11E3	AH165-L5□11E3
				AH164-L□22E3	AH165-L□22E3	AH164-L5□22E3	AH165-L5□22E3
				AH164-L□33E3	AH165-L□33E3	AH164-L5□33E3	AH165-L5□33E3
	Spot LED	24V DC	1NO+1NC 2NO+2NC 3NO+3NC	AH164-L□11E2	AH165-L□11E2	AH164-L5□11E2	AH165-L5□11E2
				AH164-L□22E2	AH165-L□22E2	AH164-L5□22E2	AH165-L5□22E2
				AH164-L□33E2	AH165-L□33E2	AH164-L5□33E2	AH165-L5□33E2
	Incandescent	24V AC/DC	1NO+1NC 2NO+2NC 3NO+3NC	AH164-L□11E	AH165-L□11E	AH164-L5□11E	AH165-L5□11E
				AH164-L□22E	AH165-L□22E	AH164-L5□22E	AH165-L5□22E
Neon	110V AC	1NO+1NC 2NO+2NC 3NO+3NC	AH164-L□11H1	AH165-L□11H1	AH164-L5□11H1	AH165-L5□11H1	
			AH164-L□22H1	AH165-L□22H1	AH164-L5□22H1	AH165-L5□22H1	
	220V AC	1NO+1NC 2NO+2NC 3NO+3NC	AH164-L□11M1	AH165-L□11M1	AH164-L5□11M1	AH165-L5□11M1	
			AH164-L□22M1	AH165-L□22M1	AH164-L5□22M1	AH165-L5□22M1	
 SK-1102	Flat LED	24V DC	1NO+1NC 2NO+2NC 3NO+3NC	AH164-SL□11E3	AH165-SL□11E3	AH164-SL5□11E3	AH165-SL5□11E3
				AH164-SL□22E3	AH165-SL□22E3	AH164-SL5□22E3	AH165-SL5□22E3
				AH164-SL□33E3	AH165-SL□33E3	AH164-SL5□33E3	AH165-SL5□33E3
	Spot LED	24V DC	1NO+1NC 2NO+2NC 3NO+3NC	AH164-SL□11E2	AH165-SL□11E2	AH164-SL5□11E2	AH165-SL5□11E2
				AH164-SL□22E2	AH165-SL□22E2	AH164-SL5□22E2	AH165-SL5□22E2
				AH164-SL□33E2	AH165-SL□33E2	AH164-SL5□33E2	AH165-SL5□33E2
	Incandescent	24V AC/DC	1NO+1NC 2NO+2NC 3NO+3NC	AH164-SL□11E	AH165-SL□11E	AH164-SL5□11E	AH165-SL5□11E
				AH164-SL□22E	AH165-SL□22E	AH164-SL5□22E	AH165-SL5□22E
Neon	110V AC	1NO+1NC 2NO+2NC 3NO+3NC	AH164-SL□11H1	AH165-SL□11H1	AH164-SL5□11H1	AH165-SL5□11H1	
			AH164-SL□22H1	AH165-SL□22H1	AH164-SL5□22H1	AH165-SL5□22H1	
	220V AC	1NO+1NC 2NO+2NC 3NO+3NC	AH164-SL□11M1	AH165-SL□11M1	AH164-SL5□11M1	AH165-SL5□11M1	
			AH164-SL□22M1	AH165-SL□22M1	AH164-SL5□22M1	AH165-SL5□22M1	
 SK-1100	Flat LED	24V DC	1NO+1NC 2NO+2NC 3NO+3NC	AH164-TL□11E3	AH165-TL□11E3	AH164-TL5□11E3	AH165-TL5□11E3
				AH164-TL□22E3	AH165-TL□22E3	AH164-TL5□22E3	AH165-TL5□22E3
				AH164-TL□33E3	AH165-TL□33E3	AH164-TL5□33E3	AH165-TL5□33E3
	Spot LED	24V DC	1NO+1NC 2NO+2NC 3NO+3NC	AH164-TL□11E2	AH165-TL□11E2	AH164-TL5□11E2	AH165-TL5□11E2
				AH164-TL□22E2	AH165-TL□22E2	AH164-TL5□22E2	AH165-TL5□22E2
				AH164-TL□33E2	AH165-TL□33E2	AH164-TL5□33E2	AH165-TL5□33E2
	Incandescent	24V AC/DC	1NO+1NC 2NO+2NC 3NO+3NC	AH164-TL□11E	AH165-TL□11E	AH164-TL5□11E	AH165-TL5□11E
				AH164-TL□22E	AH165-TL□22E	AH164-TL5□22E	AH165-TL5□22E
Neon	110V AC	1NO+1NC 2NO+2NC 3NO+3NC	AH164-TL□11H1	AH165-TL□11H1	AH164-TL5□11H1	AH165-TL5□11H1	
			AH164-TL□22H1	AH165-TL□22H1	AH164-TL5□22H1	AH165-TL5□22H1	
	220V AC	1NO+1NC 2NO+2NC 3NO+3NC	AH164-TL□11M1	AH165-TL□11M1	AH164-TL5□11M1	AH165-TL5□11M1	
			AH164-TL□22M1	AH165-TL□22M1	AH164-TL5□22M1	AH165-TL5□22M1	
220V AC	1NO+1NC 2NO+2NC 3NO+3NC	AH164-TL□33M1	AH165-TL□33M1	AH164-TL5□33M1	AH165-TL5□33M1		

Note: Replace the □ mark by the button color code, see page 137.

# Illuminated Pushbuttons AH164 and AH165

Operator	Lamp	Voltage	Contact	Momentary action		Alternate action	
				AH164 type	AH165 (oil-tight) type	AH164 type	AH165 (oil-tight) type
Flush rectangular head with guard   SK-1101	Flat LED	24V DC	1NO+1NC 2NO+2NC 3NO+3NC	AH164-TGL□11E3	AH165-TGL□11E3	AH164-TGL5□11E3	AH165-TGL5□11E3
				AH164-TGL□22E3	AH165-TGL□22E3	AH164-TGL5□22E3	AH165-TGL5□22E3
				AH164-TGL□33E3	AH165-TGL□33E3	AH164-TGL5□33E3	AH165-TGL5□33E3
	Incandescent	24V AC/DC	1NO+1NC 2NO+2NC 3NO+3NC	AH164-TGL□11E	AH165-TGL□11E	AH164-TGL5□11E	AH165-TGL5□11E
				AH164-TGL□22E	AH165-TGL□22E	AH164-TGL5□22E	AH165-TGL5□22E
	Neon	110V AC	1NO+1NC 2NO+2NC 3NO+3NC	AH164-TGL□11H1	AH165-TGL□11H1	AH164-TGL5□11H1	AH165-TGL5□11H1
AH164-TGL□22H1				AH165-TGL□22H1	AH164-TGL5□22H1	AH165-TGL5□22H1	
220V AC		1NO+1NC 2NO+2NC 3NO+3NC	AH164-TGL□11M1	AH165-TGL□11M1	AH164-TGL5□11M1	AH165-TGL5□11M1	
			AH164-TGL□22M1	AH165-TGL□22M1	AH164-TGL5□22M1	AH165-TGL5□22M1	
Flush square head with guard   AF90-301	Flat LED	24V DC	1NO+1NC 2NO+2NC 3NO+3NC	AH164-SGL□11E3	AH165-SGL□11E3	AH164-SGL5□11E3	AH165-SGL5□11E3
				AH164-SGL□22E3	AH165-SGL□22E3	AH164-SGL5□22E3	AH165-SGL5□22E3
				AH164-SGL□33E3	AH165-SGL□33E3	AH164-SGL5□33E3	AH165-SGL5□33E3
	Incandescent	24V AC/DC	1NO+1NC 2NO+2NC 3NO+3NC	AH164-SGL□11E	AH165-SGL□11E	AH164-SGL5□11E	AH165-SGL5□11E
				AH164-SGL□22E	AH165-SGL□22E	AH164-SGL5□22E	AH165-SGL5□22E
	Neon	110V AC	1NO+1NC 2NO+2NC 3NO+3NC	AH164-SGL□11H1	AH165-SGL□11H1	AH164-SGL5□11H1	AH165-SGL5□11H1
AH164-SGL□22H1				AH165-SGL□22H1	AH164-SGL5□22H1	AH165-SGL5□22H1	
220V AC		1NO+1NC 2NO+2NC 3NO+3NC	AH164-SGL□11M1	AH165-SGL□11M1	AH164-SGL5□11M1	AH165-SGL5□11M1	
			AH164-SGL□22M1	AH165-SGL□22M1	AH164-SGL5□22M1	AH165-SGL5□22M1	
				AH164-SGL□33M1	AH165-SGL□33M1	AH164-SGL5□33M1	AH165-SGL5□33M1

## ■ Dimensions, mm

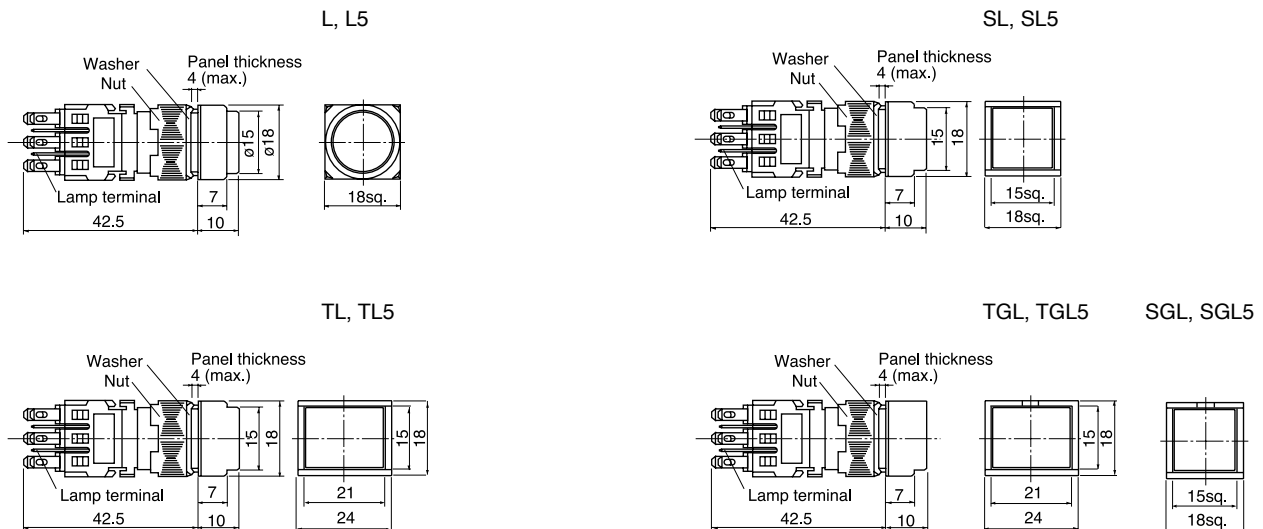

### • Button color

Color	Green	Red	White	Yellow	Blue	Orange
Code	G	R	W	Y	S	O

- The color lens is made of a tinted transparent material.
- A white illuminated pushbutton is fitted with a transparent color lens. (Except the neon lamp)
- With wire-wrap pin terminals have a depth of 47mm.





### • Lamp voltage

Voltages other than above are available

Code	LED	Incandescent	Neon
AA	5V DC	—	—
A	6V DC	5V AC/DC	—
B	12V DC	12V AC/DC	—
K	—	—	120V AC
P	—	—	240V AC

# Illuminated Pushbuttons AH164 and AH165





## ■ Illuminated pushbutton switches/without transformer (Red/green LED)

Operator	Lamp	Voltage	Contact	Momentary action		Alternate action	
				AH164 type	AH165 (oil-tight) type	AH164 type	AH165 (oil-tight) type
Extended round head  SK-1103	Red/green LED	24V DC	1NO+1NC	<b>AH164-LRG11E3</b>	<b>AH165-LRG11E3</b>	<b>AH164-L5RG11E3</b>	<b>AH165-L5RG11E3</b>
			2NO+2NC	<b>AH164-LRG22E3</b>	<b>AH165-LRG22E3</b>	<b>AH164-L5RG22E3</b>	<b>AH165-L5RG22E3</b>
			3NO+3NC	<b>AH164-LRG33E3</b>	<b>AH165-LRG33E3</b>	<b>AH164-L5RG33E3</b>	<b>AH165-L5RG33E3</b>
Flush square head  SK-1102	Red/green LED	24V DC	1NO+1NC	<b>AH164-SLRG11E3</b>	<b>AH165-SLRG11E3</b>	<b>AH164-SL5RG11E3</b>	<b>AH165-SL5RG11E3</b>
			2NO+2NC	<b>AH164-SLRG22E3</b>	<b>AH165-SLRG22E3</b>	<b>AH164-SL5RG22E3</b>	<b>AH165-SL5RG22E3</b>
			3NO+3NC	<b>AH164-SLRG33E3</b>	<b>AH165-SLRG33E3</b>	<b>AH164-SL5RG33E3</b>	<b>AH165-SL5RG33E3</b>
Flush rectangular head  SK-1100	Red/green LED	24V DC	1NO+1NC	<b>AH164-TLRG11E3</b>	<b>AH165-TLRG11E3</b>	<b>AH164-TL5RG11E3</b>	<b>AH165-TL5RG11E3</b>
			2NO+2NC	<b>AH164-TLRG22E3</b>	<b>AH165-TLRG22E3</b>	<b>AH164-TL5RG22E3</b>	<b>AH165-TL5RG22E3</b>
			3NO+3NC	<b>AH164-TLRG33E3</b>	<b>AH165-TLRG33E3</b>	<b>AH164-TL5RG33E3</b>	<b>AH165-TL5RG33E3</b>
Flush square head with guard  AF90-301	Red/green LED	24V DC	1NO+1NC	<b>AH164-SGLRG11E3</b>	<b>AH165-SGLRG11E3</b>	<b>AH164-SGL5RG11E3</b>	<b>AH165-SGL5RG11E3</b>
			2NO+2NC	<b>AH164-SGLRG22E3</b>	<b>AH165-SGLRG22E3</b>	<b>AH164-SGL5RG22E3</b>	<b>AH165-SGL5RG22E3</b>
			3NO+3NC	<b>AH164-SGLRG33E3</b>	<b>AH165-SGLRG33E3</b>	<b>AH164-SGL5RG33E3</b>	<b>AH165-SGL5RG33E3</b>
Flush rectangular head with guard  SK-1101	Red/green LED	24V DC	1NO+1NC	<b>AH164-TGLRG11E3</b>	<b>AH165-TGLRG11E3</b>	<b>AH164-TGL5RG11E3</b>	<b>AH165-TGL5RG11E3</b>
			2NO+2NC	<b>AH164-TGLRG22E3</b>	<b>AH165-TGLRG22E3</b>	<b>AH164-TGL5RG22E3</b>	<b>AH165-TGL5RG22E3</b>
			3NO+3NC	<b>AH164-TGLRG33E3</b>	<b>AH165-TGLRG33E3</b>	<b>AH164-TGL5RG33E3</b>	<b>AH165-TGL5RG33E3</b>

Note: • The only color codes used for red/green LEDs are R and G. The color lens is transparent.  
 Red/green LEDs do not have high-brightness specifications.  
 • 24V DC only

# Illuminated Pushbuttons AH164 and AH165

## ■ Illuminated pushbutton switches/with transformer

Operator	Lamp	Voltage	Contact	Momentary action		Alternate action	
				AH164 type	AH165 (oil-tight) type	AH164 type	AH165 (oil-tight) type
Extended round head 	Flat LED	■ Voltage code H: 100-110V AC M: 200-220V AC	1NO+1NC	AH164-L□11■3	AH165-L□11■3	AH164-L5□11■3	AH165-L5□11■3
			2NO+2NC	AH164-L□22■3	AH165-L□22■3	AH164-L5□22■3	AH165-L5□22■3
	Incandescent		1NO+1NC	AH164-L□11■	AH165-L□11■	AH164-L5□11■	AH165-L5□11■
			2NO+2NC	AH164-L□22■	AH165-L□22■	AH164-L5□22■	AH165-L5□22■
Flush square head 	Flat LED	■ Voltage code H: 100-110V AC M: 200-220V AC	1NO+1NC	AH164-SL□11■3	AH165-SL□11■3	AH164-SL5□11■3	AH165-SL5□11■3
			2NO+2NC	AH164-SL□22■3	AH165-SL□22■3	AH164-SL5□22■3	AH165-SL5□22■3
	Incandescent		1NO+1NC	AH164-SL□11■	AH165-SL□11■	AH164-SL5□11■	AH165-SL5□11■
			2NO+2NC	AH164-SL□22■	AH165-SL□22■	AH164-SL5□22■	AH165-SL5□22■
Flush rectangular head 	Flat LED	■ Voltage code H: 100-110V AC M: 200-220V AC	1NO+1NC	AH164-TL□11■3	AH165-TL□11■3	AH164-TL5□11■3	AH165-TL5□11■3
			2NO+2NC	AH164-TL□22■3	AH165-TL□22■3	AH164-TL5□22■3	AH165-TL5□22■3
	Incandescent		1NO+1NC	AH164-TL□11■	AH165-TL□11■	AH164-TL5□11■	AH165-TL5□11■
			2NO+2NC	AH164-TL□22■	AH165-TL□22■	AH164-TL5□22■	AH165-TL5□22■
Flush rectangular head with guard 	Flat LED	■ Voltage code H: 100-110V AC M: 200-220V AC	1NO+1NC	AH164-TGL□11■3	AH165-TGL□11■3	AH164-TGL5□11■3	AH165-TGL5□11■3
			2NO+2NC	AH164-TGL□22■3	AH165-TGL□22■3	AH164-TGL5□22■3	AH165-TGL5□22■3
	Incandescent		1NO+1NC	AH164-TGL□11■	AH165-TGL□11■	AH164-TGL5□11■	AH165-TGL5□11■
			2NO+2NC	AH164-TGL□22■	AH165-TGL□22■	AH164-TGL5□22■	AH165-TGL5□22■
Flush square head with guard 	Flat LED	■ Voltage code H: 100-110V AC M: 200-220V AC	1NO+1NC	AH164-SGL□11■3	AH165-SGL□11■3	AH164-SGL5□11■3	AH165-SGL5□11■3
			2NO+2NC	AH164-SGL□22■3	AH165-SGL□22■3	AH164-SGL5□22■3	AH165-SGL5□22■3
	Incandescent		1NO+1NC	AH164-SGL□11■	AH165-SGL□11■	AH164-SGL5□11■	AH165-SGL5□11■
			2NO+2NC	AH164-SGL□22■	AH165-SGL□22■	AH164-SGL5□22■	AH165-SGL5□22■

Note: Replace the □ mark by the button color code, see page 140.

# Illuminated Pushbuttons AH164 and AH165

## ■ Dimensions, mm

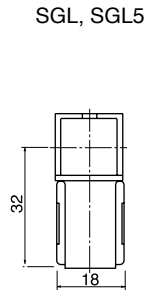
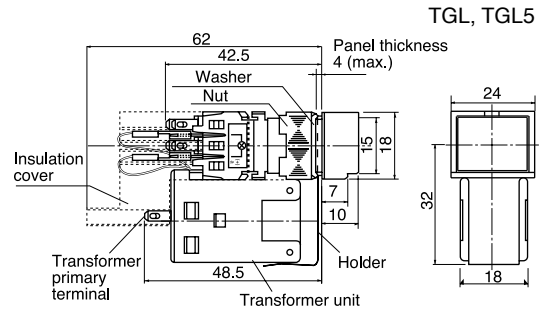
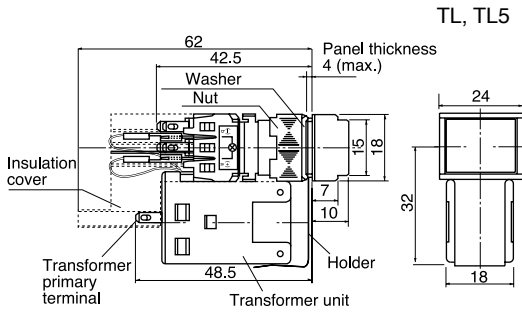
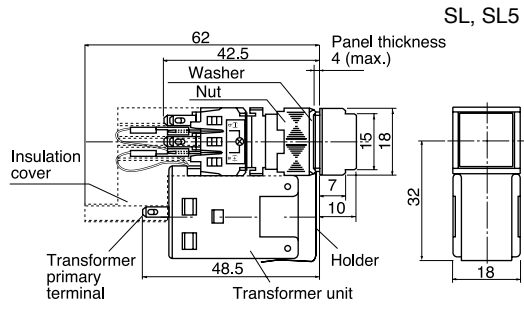
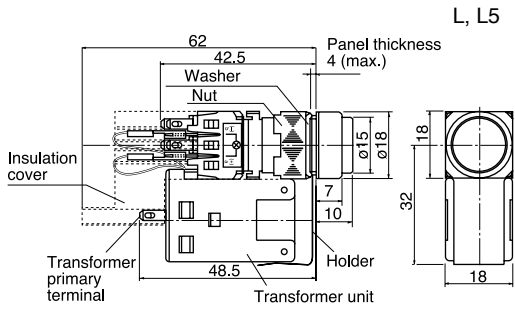









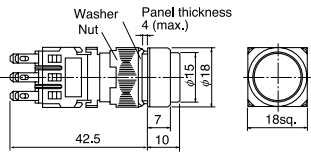

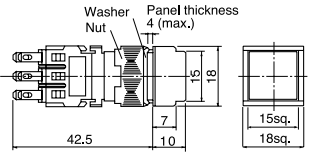

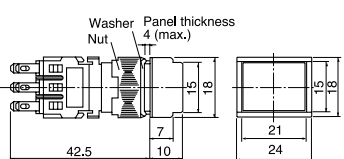

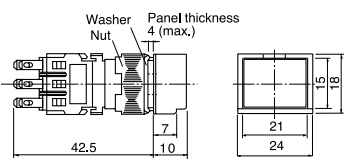
### •Button color

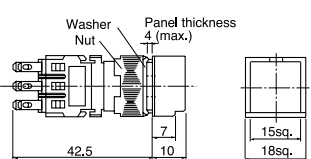
Color	Green	Red	White	Yellow	Blue	Orange
Code	G	R	W	Y	S	O

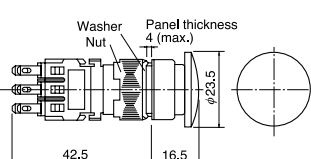
• The color lens is made of a tinted transparent material.

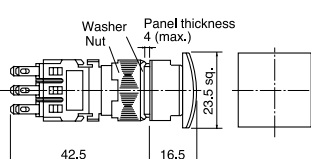
## ■ Pushbutton switches

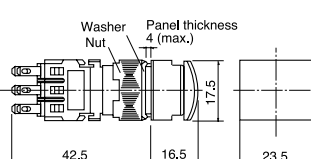
Operator	Contact	Momentary action		Alternate action		Dimensions, mm
		AH164 type	AH165 (oil-tight) type	AH164 type	AH165 (oil-tight) type	
Extended round head 	1NO+1NC	AH164-E□11	AH165-E□11	AH164-E5□11	AH165-E5□11	
	2NO+2NC	AH164-E□22	AH165-E□22	AH164-E5□22	AH165-E5□22	
	3NO+3NC	AH164-E□33	AH165-E□33	AH164-E5□33	AH165-E5□33	
Flush square head 	1NO+1NC	AH164-SF□11	AH165-SF□11	AH164-SF5□11	AH165-SF5□11	
	2NO+2NC	AH164-SF□22	AH165-SF□22	AH164-SF5□22	AH165-SF5□22	
	3NO+3NC	AH164-SF□33	AH165-SF□33	AH164-SF5□33	AH165-SF5□33	
Flush rectangular head 	1NO+1NC	AH164-TF□11	AH165-TF□11	AH164-TF5□11	AH165-TF5□11	
	2NO+2NC	AH164-TF□22	AH165-TF□22	AH164-TF5□22	AH165-TF5□22	
	3NO+3NC	AH164-TF□33	AH165-TF□33	AH164-TF5□33	AH165-TF5□33	
Flush rectangular head with guard 	1NO+1NC	AH164-TGF□11	AH165-TGF□11	AH164-TGF5□11	AH165-TGF5□11	
	2NO+2NC	AH164-TGF□22	AH165-TGF□22	AH164-TGF5□22	AH165-TGF5□22	
	3NO+3NC	AH164-TGF□33	AH165-TGF□33	AH164-TGF5□33	AH165-TGF5□33	
Flush square head with guard 	1NO+1NC	AH164-SGF□11	AH165-SGF□11	AH164-SGF5□11	AH165-SGF5□11	
	2NO+2NC	AH164-SGF□22	AH165-SGF□22	AH164-SGF5□22	AH165-SGF5□22	
	3NO+3NC	AH164-SGF□33	AH165-SGF□33	AH164-SGF5□33	AH165-SGF5□33	
Mushroom head 	1NO+1NC	AH164-M□11	AH165-M□11	AH164-M5□11	AH165-M5□11	
	2NO+2NC	AH164-M□22	AH165-M□22	AH164-M5□22	AH165-M5□22	
	3NO+3NC	AH164-M□33	AH165-M□33	AH164-M5□33	AH165-M5□33	
Convex square head 	1NO+1NC	AH164-SM□11	AH165-SM□11	AH164-SM5□11	AH165-SM5□11	
	2NO+2NC	AH164-SM□22	AH165-SM□22	AH164-SM5□22	AH165-SM5□22	
	3NO+3NC	AH164-SM□33	AH165-SM□33	AH164-SM5□33	AH165-SM5□33	
Convex rectangular head 	1NO+1NC	AH164-TM□11	AH165-TM□11	AH164-TM5□11	AH165-TM5□11	
	2NO+2NC	AH164-TM□22	AH165-TM□22	AH164-TM5□22	AH165-TM5□22	
	3NO+3NC	AH164-TM□33	AH165-TM□33	AH164-TM5□33	AH165-TM5□33	

### •Button color

Replace the □ mark by the following color code

Color	Green	Red	Black	White	Blue	Yellow	Orange
Code	G	R	B	W	S	Y	O



- The color lens is made of a tinted transparent material. (Except the M, SM, TM types)
- A white pushbutton is fitted with a transparent color lens. (Except the M, SM, TM types) A black pushbutton consists of a transparent color lens and an attached black legend plate. (Except M, SM, TM types)
- With wire-wrap pin terminals have a depth of 47mm.

# Pushbuttons

## AH165

### ■ Pushbutton switches

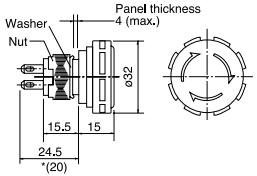

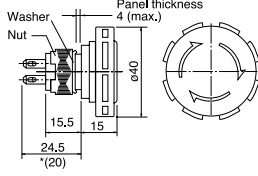
⊖ (Direct opening action)

Operator	Button color	Contact	Terminal	AH165 (oil-tight) type	Dimensions, mm
Push-lock, turn-reset (32mm dia.)    <small>AF91-584</small>	Red	1NC	Solder/Tab Solder	<b>AH165-VR01</b> <b>(AH165-VR01-S)</b>	
		2NC		<b>AH165-VR02</b> <b>(AH165-VR02-S)</b>	
Push-lock, turn-reset (40mm dia.)    <small>AF91-583</small>	Red	1NC	Solder/Tab Solder	<b>AH165-V1R01</b> <b>(AH165-V1R01-S)</b>	
		2NC		<b>AH165-V1R02</b> <b>(AH165-V1R02-S)</b>	

Notes: \* ( ) For switch with solder terminal.  
 • Contact arrangements indicated in the table can be supplied.  
 • Product with no trigger action mechanism.

### ■ Emergency stop pushbutton switches

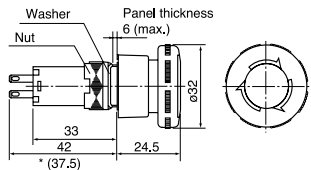

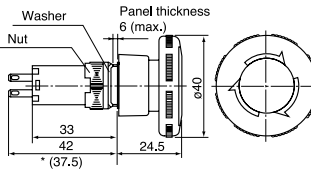







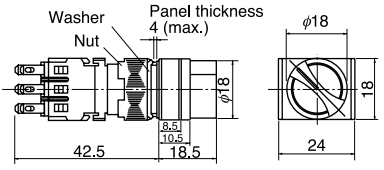

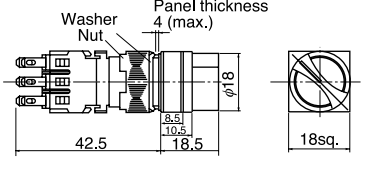



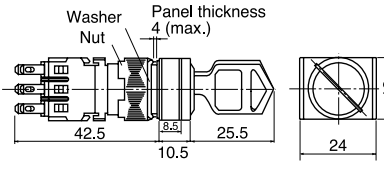





⊖ (Direct opening action), conform to EN418

Operator	Button color	Contact	Terminal	AH165 (oil-tight) type	Dimensions, mm
Push-lock, turn-reset (32mm dia.)    <small>AF97-232</small>	Red	1NC	Solder/Tab Solder	<b>AH165-V5R01</b> <b>(AH165-V5R01-S)</b>	
		2NC		<b>AH165-V5R02</b> <b>(AH165-V5R02-S)</b>	
Push-lock, turn-reset (40mm dia.)    <small>AF97-231</small>	Red	1NC	Solder/Tab Solder	<b>AH165-V6R01</b> <b>(AH165-V6R01-S)</b>	
		2NC		<b>AH165-V6R02</b> <b>(AH165-V6R02-S)</b>	

Notes: \* ( ) For switch with solder terminal.  
 • Contact arrangements indicated in the table can be supplied.



## ■ Selector switches/2-position (90-degree)

Operator	Operation	Key removable position	Contact	AH164 type	AH165 (oil-tight) type	Dimensions, mm	
Knob with rectangular bezel  AF89-564	Maintained	—	1NO+1NC 2NO+2NC 3NO+3NC	AH164-P2B11 AH164-P2B22 AH164-P2B33	AH165-P2B11 AH165-P2B22 AH165-P2B33		
	Spring return 	—	1NO+1NC 2NO+2NC 3NO+3NC	AH164-P0B11 AH164-P0B22 AH164-P0B33	AH165-P0B11 AH165-P0B22 AH165-P0B33		
Knob with square bezel  AF89-563	Maintained	—	1NO+1NC 2NO+2NC 3NO+3NC	AH164-SP2B11 AH164-SP2B22 AH164-SP2B33	AH165-SP2B11 AH165-SP2B22 AH165-SP2B33		
	Spring return 	—	1NO+1NC 2NO+2NC 3NO+3NC	AH164-SP0B11 AH164-SP0B22 AH164-SP0B33	AH165-SP0B11 AH165-SP0B22 AH165-SP0B33		
Key with rectangular bezel  AF89-561	Maintained		1NO+1NC 2NO+2NC 3NO+3NC	AH164-J2A11A AH164-J2A22A AH164-J2A33A	AH165-J2A11A AH165-J2A22A AH165-J2A33A		
			1NO+1NC 2NO+2NC 3NO+3NC	AH164-J2B11A AH164-J2B22A AH164-J2B33A	AH165-J2B11A AH165-J2B22A AH165-J2B33A		
			1NO+1NC 2NO+2NC 3NO+3NC	AH164-J2D11A AH164-J2D22A AH164-J2D33A	AH165-J2D11A AH165-J2D22A AH165-J2D33A		
	Spring return 		1NO+1NC 2NO+2NC 3NO+3NC	AH164-J0A11A AH164-J0A22A AH164-J0A33A	AH165-J0A11A AH165-J0A22A AH165-J0A33A		
	Maintained		1NO+1NC 2NO+2NC 3NO+3NC	AH164-SJ2A11A AH164-SJ2A22A AH164-SJ2A33A	AH165-SJ2A11A AH165-SJ2A22A AH165-SJ2A33A		
				1NO+1NC 2NO+2NC 3NO+3NC	AH164-SJ2B11A AH164-SJ2B22A AH164-SJ2B33A		AH165-SJ2B11A AH165-SJ2B22A AH165-SJ2B33A
				1NO+1NC 2NO+2NC 3NO+3NC	AH164-SJ2D11A AH164-SJ2D22A AH164-SJ2D33A		AH165-SJ2D11A AH165-SJ2D22A AH165-SJ2D33A
		Spring return 		1NO+1NC 2NO+2NC 3NO+3NC	AH164-SJ0A11A AH164-SJ0A22A AH164-SJ0A33A		AH165-SJ0A11A AH165-SJ0A22A AH165-SJ0A33A
Key with square bezel  AF89-562		Maintained		1NO+1NC 2NO+2NC 3NO+3NC	AH164-SJ2A11A AH164-SJ2A22A AH164-SJ2A33A	AH165-SJ2A11A AH165-SJ2A22A AH165-SJ2A33A	
				1NO+1NC 2NO+2NC 3NO+3NC	AH164-SJ2B11A AH164-SJ2B22A AH164-SJ2B33A	AH165-SJ2B11A AH165-SJ2B22A AH165-SJ2B33A	
				1NO+1NC 2NO+2NC 3NO+3NC	AH164-SJ2D11A AH164-SJ2D22A AH164-SJ2D33A	AH165-SJ2D11A AH165-SJ2D22A AH165-SJ2D33A	
	Spring return 		1NO+1NC 2NO+2NC 3NO+3NC	AH164-SJ0A11A AH164-SJ0A22A AH164-SJ0A33A	AH165-SJ0A11A AH165-SJ0A22A AH165-SJ0A33A		

• The operating angle range can be changed as shown below by setting the attached flange shifted by 45° in combination with the contact block.  
In this case, the minimum mounting pitch is 26mm because the contact block is shifted by 45° from the flange.

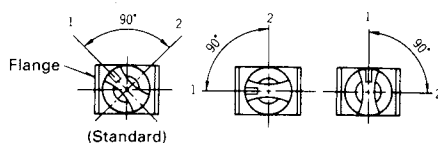

### • Contact block position

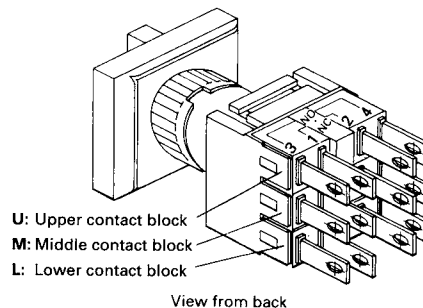

### • Contact arrangement and operator position: 2-position selector switch

Contact arrangement	1NO+1NC	2NO+2NC	3NO+3NC	
Operator position	Left	M 1 0 1 0 2 3 0 0 4	U 1 0 1 0 2 3 0 0 4 L 3 0 0 4	U 1 0 1 0 2 3 0 0 4 M 1 0 1 0 2 3 0 0 4 L 1 0 1 0 2 3 0 0 4
	Right	M 1 0 1 0 2 3 0 0 4	U 1 0 1 0 2 3 0 0 4 L 3 0 0 4	U 1 0 1 0 2 3 0 0 4 M 1 0 1 0 2 3 0 0 4 L 1 0 1 0 2 3 0 0 4

### 3-position selector switch





Contact arrangement	2NO+2NC	3NO+3NC	
Operator position	Left	U 1 0 1 0 2 3 0 0 4 L 3 0 0 4	U 1 0 1 0 2 3 0 0 4 M 1 0 1 0 2 3 0 0 4 L 1 0 1 0 2 3 0 0 4
	Center	U 1 0 1 0 2 3 0 0 4 L 3 0 0 4	U 1 0 1 0 2 3 0 0 4 M 1 0 1 0 2 3 0 0 4 L 1 0 1 0 2 3 0 0 4
	Right	U 1 0 1 0 2 3 0 0 4 L 3 0 0 4	U 1 0 1 0 2 3 0 0 4 M 1 0 1 0 2 3 0 0 4 L 1 0 1 0 2 3 0 0 4

- There are 6 available key types; A, B, C, D, E and F. Standard key code is A.
- With wire-wrap pin terminals have a depth of 47mm.

# Selector Switches AH165

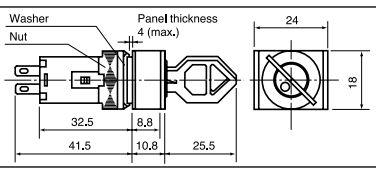
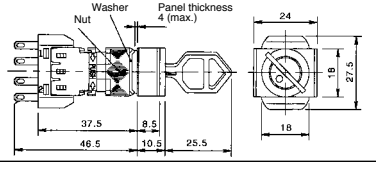

## ■ Selector switches/2-position (90-degree)

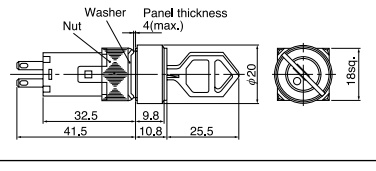
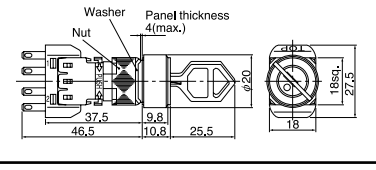
⊖ (Direct opening action)

Operator	Operation	Key removable position	Contact	AH165 (oil-tight) type	Dimensions, mm	
Key with rectangular bezel  AF95-57  AF97-334	Maintained	A ⊖	1NO+1NC	AH165-JM2A11A		
		B ⊗		AH165-JM2B11A		
		D ⊕		AH165-JM2D11A		
		A ⊖	2NO+2NC	A ⊖	AH165-JM2A22A	
				B ⊗	AH165-JM2B22A	
				D ⊕	AH165-JM2D22A	
Key with round bezel  AF99-320	Maintained	A ⊖	1NO+1NC	AH165-RJM2A11A		
		B ⊗		AH165-RJM2B11A		
		D ⊕		AH165-RJM2D11A		
		A ⊖	2NO+2NC	A ⊖	AH165-RJM2A22A	
				B ⊗	AH165-RJM2B22A	
				D ⊕	AH165-RJM2D22A	

• There are 6 available key types; A, B, C, D, E and F. Standard key code is A.

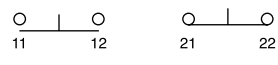
### • Contact arrangement and operator positions: 2-position selector switch





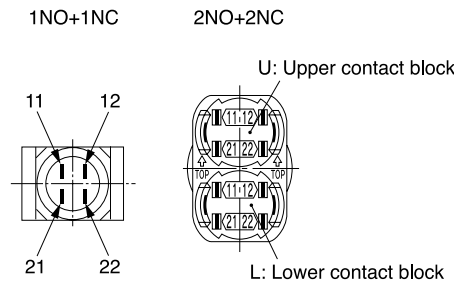

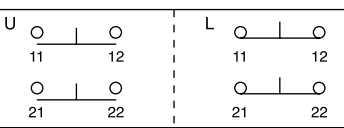
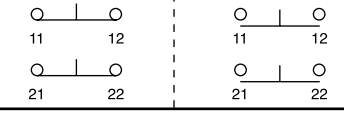
Contact arrangement	1NO+1NC	
Operator position	Left	
	Right	

### • Terminal number

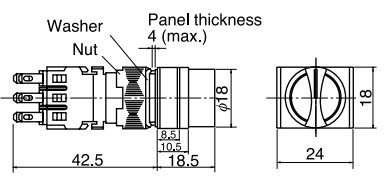

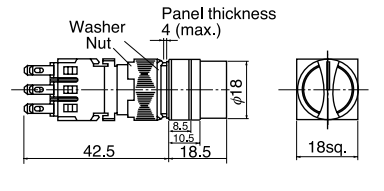
Contact arrangement	2NO+2NC	
Operator position	Left	
	Right	

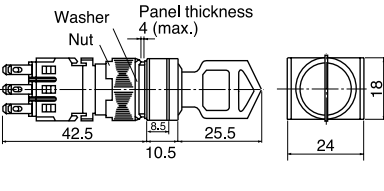
## ■ Selector switches/3-position (90-degree)

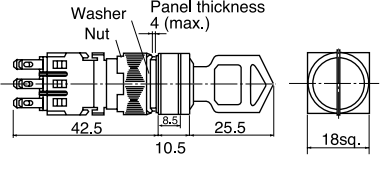





Operator	Operation	Key removable position	Contact	AH164 type	AH165 (oil-tight) type	Dimensions, mm		
Knob with rectangular bezel   SK-1099	Maintained	—	2NO+2NC 3NO+3NC	<b>AH164-P3B22</b> <b>AH164-P3B33</b>	<b>AH165-P3B22</b> <b>AH165-P3B33</b>			
	Spring/ manual return	—	2NO+2NC 3NO+3NC	<b>AH164-P6B22</b> <b>AH164-P6B33</b>	<b>AH165-P6B22</b> <b>AH165-P6B33</b>			
	Spring/ manual return	—	2NO+2NC 3NO+3NC	<b>AH164-P7B22</b> <b>AH164-P7B33</b>	<b>AH165-P7B22</b> <b>AH165-P7B33</b>			
	Spring return	—	2NO+2NC 3NO+3NC	<b>AH164-P1B22</b> <b>AH164-P1B33</b>	<b>AH165-P1B22</b> <b>AH165-P1B33</b>			
Knob with square bezel   SK-1133	Maintained	—	2NO+2NC 3NO+3NC	<b>AH164-SP3B22</b> <b>AH164-SP3B33</b>	<b>AH165-SP3B22</b> <b>AH165-SP3B33</b>			
	Spring/ manual return	—	2NO+2NC 3NO+3NC	<b>AH164-SP6B22</b> <b>AH164-SP6B33</b>	<b>AH165-SP6B22</b> <b>AH165-SP6B33</b>			
	Spring/ manual return	—	2NO+2NC 3NO+3NC	<b>AH164-SP7B22</b> <b>AH164-SP7B33</b>	<b>AH165-SP7B22</b> <b>AH165-SP7B33</b>			
	Spring return	—	2NO+2NC 3NO+3NC	<b>AH164-SP1B22</b> <b>AH164-SP1B33</b>	<b>AH165-SP1B22</b> <b>AH165-SP1B33</b>			
Key with rectangular bezel   SK-1098	Maintained*	⊖ A	2NO+2NC 3NO+3NC	<b>AH164-J3A22A</b> <b>AH164-J3A33A</b>	<b>AH165-J3A22A</b> <b>AH165-J3A33A</b>			
		⊕ E	2NO+2NC 3NO+3NC	<b>AH164-J3E22A</b> <b>AH164-J3E33A</b>	<b>AH165-J3E22A</b> <b>AH165-J3E33A</b>			
		⊖ D	2NO+2NC 3NO+3NC	<b>AH164-J3D22A</b> <b>AH164-J3D33A</b>	<b>AH165-J3D22A</b> <b>AH165-J3D33A</b>			
		⊕ C	2NO+2NC 3NO+3NC	<b>AH164-J3C22A</b> <b>AH164-J3C33A</b>	<b>AH165-J3C22A</b> <b>AH165-J3C33A</b>			
	Spring/ manual return	⊕ E	2NO+2NC 3NO+3NC	<b>AH164-J6E22A</b> <b>AH164-J6E33A</b>	<b>AH165-J6E22A</b> <b>AH165-J6E33A</b>			
		⊖ D	2NO+2NC 3NO+3NC	<b>AH164-J6D22A</b> <b>AH164-J6D33A</b>	<b>AH165-J6D22A</b> <b>AH165-J6D33A</b>			
	Spring/ manual return	⊖ A	2NO+2NC 3NO+3NC	<b>AH164-J7A22A</b> <b>AH164-J7A33A</b>	<b>AH165-J7A22A</b> <b>AH165-J7A33A</b>			
		⊕ E	2NO+2NC 3NO+3NC	<b>AH164-J7E22A</b> <b>AH164-J7E33A</b>	<b>AH165-J7E22A</b> <b>AH165-J7E33A</b>			
	Spring return	⊕ E	2NO+2NC 3NO+3NC	<b>AH164-J1E22A</b> <b>AH164-J1E33A</b>	<b>AH165-J1E22A</b> <b>AH165-J1E33A</b>			
	Key with square bezel   SK-1132	Maintained*	⊖ A	2NO+2NC 3NO+3NC	<b>AH164-SJ3A22A</b> <b>AH164-SJ3A33A</b>		<b>AH165-SJ3A22A</b> <b>AH165-SJ3A33A</b>	
			⊕ E	2NO+2NC 3NO+3NC	<b>AH164-SJ3E22A</b> <b>AH164-SJ3E33A</b>		<b>AH165-SJ3E22A</b> <b>AH165-SJ3E33A</b>	
			⊖ D	2NO+2NC 3NO+3NC	<b>AH164-SJ3D22A</b> <b>AH164-SJ3D33A</b>		<b>AH165-SJ3D22A</b> <b>AH165-SJ3D33A</b>	
⊕ C			2NO+2NC 3NO+3NC	<b>AH164-SJ3C22A</b> <b>AH164-SJ3C33A</b>	<b>AH165-SJ3C22A</b> <b>AH165-SJ3C33A</b>			
Spring/ manual return		⊕ E	2NO+2NC 3NO+3NC	<b>AH164-SJ6E22A</b> <b>AH164-SJ6E33A</b>	<b>AH165-SJ6E22A</b> <b>AH165-SJ6E33A</b>			
		⊖ D	2NO+2NC 3NO+3NC	<b>AH164-SJ6D22A</b> <b>AH164-SJ6D33A</b>	<b>AH165-SJ6D22A</b> <b>AH165-SJ6D33A</b>			
Spring/ manual return		⊖ A	2NO+2NC 3NO+3NC	<b>AH164-SJ7A22A</b> <b>AH164-SJ7A33A</b>	<b>AH165-SJ7A22A</b> <b>AH165-SJ7A33A</b>			
		⊕ E	2NO+2NC 3NO+3NC	<b>AH164-SJ7E22A</b> <b>AH164-SJ7E33A</b>	<b>AH165-SJ7E22A</b> <b>AH165-SJ7E33A</b>			
Spring return		⊕ E	2NO+2NC 3NO+3NC	<b>AH164-SJ1E22A</b> <b>AH164-SJ1E33A</b>	<b>AH165-SJ1E22A</b> <b>AH165-SJ1E33A</b>			

- There are 6 available key types; A, B, C, D, E and F. Standard key code is A.
- Contact arrangement and operator position: *See page 147.*
- Spring return, spring/manual return (spring return): Operation angle 70-degree

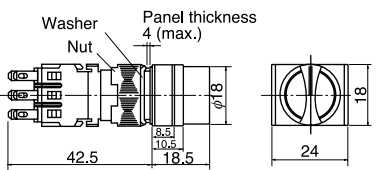
- \* Available key removable position: Code B ⊖
- With wire-wrap pin terminals have a depth of 47mm.

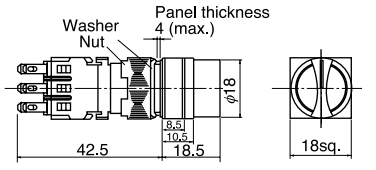
# Selector Switches AH164 and AH165

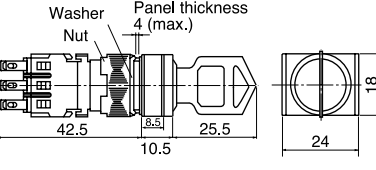
## ■ Selector switches/3-position (45-degree)

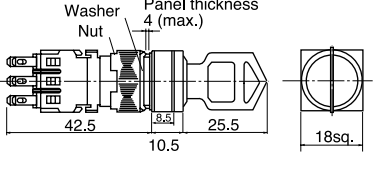
Operator	Operation	Key removable position	Contact	AH164 type	AH165 (oil-tight) type	Dimensions, mm		
Knob with rectangular bezel   SK-1099	Maintained	—	2NO+2NC 3NO+3NC	AH164-PK3B22 AH164-PK3B33	AH165-PK3B22 AH165-PK3B33			
	Spring/ manual return	—	2NO+2NC 3NO+3NC	AH164-PK6B22 AH164-PK6B33	AH165-PK6B22 AH165-PK6B33			
	Spring/ manual return	—	2NO+2NC 3NO+3NC	AH164-PK7B22 AH164-PK7B33	AH165-PK7B22 AH165-PK7B33			
	Spring return	—	2NO+2NC 3NO+3NC	AH164-PK1B22 AH164-PK1B33	AH165-PK1B22 AH165-PK1B33			
Knob with square bezel   SK-1133	Maintained	—	2NO+2NC 3NO+3NC	AH164-SPK3B22 AH164-SPK3B33	AH165-SPK3B22 AH165-SPK3B33			
	Spring/ manual return	—	2NO+2NC 3NO+3NC	AH164-SPK6B22 AH164-SPK6B33	AH165-SPK6B22 AH165-SPK6B33			
	Spring/ manual return	—	2NO+2NC 3NO+3NC	AH164-SPK7B22 AH164-SPK7B33	AH165-SPK7B22 AH165-SPK7B33			
	Spring return	—	2NO+2NC 3NO+3NC	AH164-SPK1B22 AH164-SPK1B33	AH165-SPK1B22 AH165-SPK1B33			
Key with rectangular bezel   SK-1098	Maintained	⊖ A	2NO+2NC 3NO+3NC	AH164-JK3A22A AH164-JK3A33A	AH165-JK3A22A AH165-JK3A33A			
		⊕ E	2NO+2NC 3NO+3NC	AH164-JK3E22A AH164-JK3E33A	AH165-JK3E22A AH165-JK3E33A			
		⊙ D	2NO+2NC 3NO+3NC	AH164-JK3D22A AH164-JK3D33A	AH165-JK3D22A AH165-JK3D33A			
		⊗ C	2NO+2NC 3NO+3NC	AH164-JK3C22A AH164-JK3C33A	AH165-JK3C22A AH165-JK3C33A			
	Spring/ manual return	⊕ E	2NO+2NC 3NO+3NC	AH164-JK6E22A AH164-JK6E33A	AH165-JK6E22A AH165-JK6E33A			
		⊙ D	2NO+2NC 3NO+3NC	AH164-JK6D22A AH164-JK6D33A	AH165-JK6D22A AH165-JK6D33A			
	Spring/ manual return	⊖ A	2NO+2NC 3NO+3NC	AH164-JK7A22A AH164-JK7A33A	AH165-JK7A22A AH165-JK7A33A			
		⊕ E	2NO+2NC 3NO+3NC	AH164-JK7E22A AH164-JK7E33A	AH165-JK7E22A AH165-JK7E33A			
	Spring return	⊕ E	2NO+2NC 3NO+3NC	AH164-JK1E22A AH164-JK1E33A	AH165-JK1E22A AH165-JK1E33A			
	Key with square bezel   SK-1132	Maintained	⊖ A	2NO+2NC 3NO+3NC	AH164-SJK3A22A AH164-SJK3A33A		AH165-SJK3A22A AH165-SJK3A33A	
			⊕ E	2NO+2NC 3NO+3NC	AH164-SJK3E22A AH164-SJK3E33A		AH165-SJK3E22A AH165-SJK3E33A	
			⊙ D	2NO+2NC 3NO+3NC	AH164-SJK3D22A AH164-SJK3D33A		AH165-SJK3D22A AH165-SJK3D33A	
⊗ C			2NO+2NC 3NO+3NC	AH164-SJK3C22A AH164-SJK3C33A	AH165-SJK3C22A AH165-SJK3C33A			
Spring/ manual return		⊕ E	2NO+2NC 3NO+3NC	AH164-SJK6E22A AH164-SJK6E33A	AH165-SJK6E22A AH165-SJK6E33A			
		⊙ D	2NO+2NC 3NO+3NC	AH164-SJK6D22A AH164-SJK6D33A	AH165-SJK6D22A AH165-SJK6D33A			
Spring/ manual return		⊖ A	2NO+2NC 3NO+3NC	AH164-SJK7A22A AH164-SJK7A33A	AH165-SJK7A22A AH165-SJK7A33A			
		⊕ E	2NO+2NC 3NO+3NC	AH164-SJK7E22A AH164-SJK7E33A	AH165-SJK7E22A AH165-SJK7E33A			
Spring return		⊕ E	2NO+2NC 3NO+3NC	AH164-SJK1E22A AH164-SJK1E33A	AH165-SJK1E22A AH165-SJK1E33A			

- There are 6 available key types; A, B, C, D, E and F. Standard key code is A.
- Contact arrangement and operator position: See page 147.

•Key removable positions (JK, SJK)

Remvable position							
Code	A	B	C	D	E	F	G

Operation code	Key removable position
3	A, B, C, D, E, F, G
6	D, E, F
7	A, E, G
1	E

•Key code No.

There are 6 available key types; A, B, C, D, E and F.  
Standard key code is A.

• Contact block position

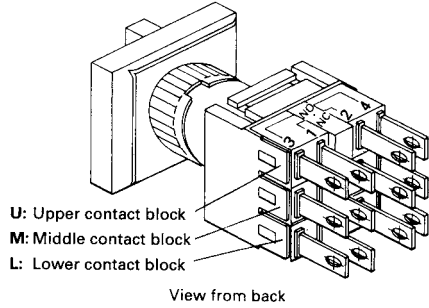





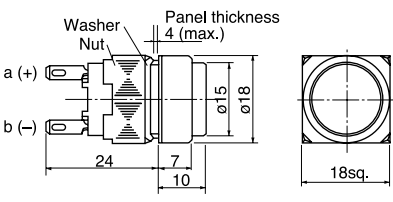

• Contact arrangement and operator position:  
3-position selector switch

Contact arrangement		2NO+2NC	3NO+3NC
Operator position	Left 	$\begin{matrix} U & L & 1O & 1O & 1O & 2O & 2O \\ 3O & 3O & 4O & 3O & 4O & 3O & 4O \end{matrix}$	$\begin{matrix} U & M & L & 1O & 1O & 1O & 2O & 2O \\ 3O & 3O & 4O & 3O & 4O & 3O & 4O & 3O & 4O \end{matrix}$
	Center 	$\begin{matrix} 1O & 1O & 2O & 1O & 1O & 2O & 2O \\ 3O & 3O & 4O & 3O & 4O & 3O & 4O \end{matrix}$	$\begin{matrix} 1O & 1O & 2O & 1O & 1O & 2O & 1O & 1O & 2O \\ 3O & 3O & 4O & 3O & 4O & 3O & 4O & 3O & 4O \end{matrix}$
	Right 	$\begin{matrix} 1O & 1O & 2O & 1O & 1O & 2O & 2O \\ 3O & 3O & 4O & 3O & 4O & 3O & 4O \end{matrix}$	$\begin{matrix} 1O & 1O & 2O & 1O & 1O & 2O & 1O & 1O & 2O \\ 3O & 3O & 4O & 3O & 4O & 3O & 4O & 3O & 4O \end{matrix}$

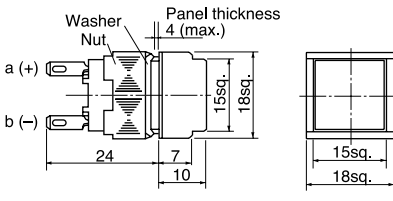
# Pilot Lights AH164 and AH165

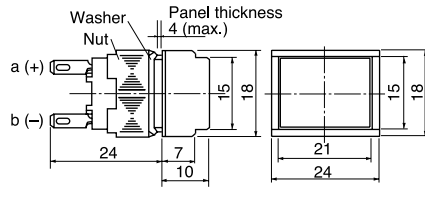
## ■ Pilot lights/without transformer

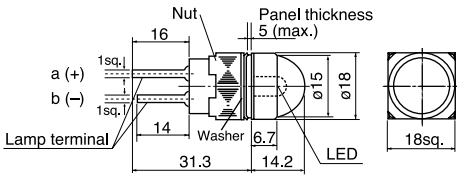
Lens	Lamp	Voltage	AH164 type	AH165 (oil-tight) type	Dimensions, mm
 SK-1139	Flat LED	24V DC	AH164-Z□E3	AH165-Z□E3	
	Spot LED	24V DC	AH164-Z□E2	AH165-Z□E2	
	Red/green LED	24V DC	AH164-ZRGE3	AH165-ZRGE3	
	Incandescent	24V AC/DC	AH164-Z□E	AH165-Z□E	
	Neon	110V AC 220V AC	AH164-Z□H1 AH164-Z□M1	AH165-Z□H1 AH165-Z□M1	
 SK-1138	Flat LED	24V DC	AH164-ZS□E3	AH165-ZS□E3	
	Spot LED	24V DC	AH164-ZS□E2	AH165-ZS□E2	
	Red/green LED	24V DC	AH164-ZSRGE3	AH165-ZSRGE3	
	Incandescent	24V AC/DC	AH164-ZS□E	AH165-ZS□E	
	Neon	110V AC 220V AC	AH164-ZS□H1 AH164-ZS□M1	AH165-ZS□H1 AH165-ZS□M1	
 SK-1137	Flat LED	24V DC	AH164-ZT□E3	AH165-ZT□E3	
	Spot LED	24V DC	AH164-ZT□E2	AH165-ZT□E2	
	Red/green LED	24V DC	AH164-ZTRGE3	AH165-ZTRGE3	
	Incandescent	24V AC/DC	AH164-ZT□E	AH165-ZT□E	
	Neon	110V AC 220V AC	AH164-ZT□H1 AH164-ZT□M1	AH165-ZT□H1 AH165-ZT□M1	
 AF87-45	LED	12V DC 24V DC	- -	AH165-ZM□B2 AH165-ZM□E2	

Note: • The only color codes used for red/green LEDs are R and G. The color lens is transparent.  
Red/green LEDs do not have high-brightness specifications.

Relationship between luminous color and terminal

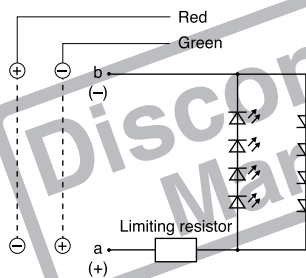

### • Lamp voltage

Voltages other than above are available

Code	LED	Incandescent	Neon
AA	5V DC	-	-
A	6V DC	5V AC/DC	-
B	12V DC	12V AC/DC	-
K	-	-	120V AC
P	-	-	240V AC

Note: Except for ZM types and red/green LED types





### • Lens color

Replace the □ mark by the following lens color code

Color	Green	Red	White	Yellow	Blue	Orange
Code	G	R	W	Y	S	O

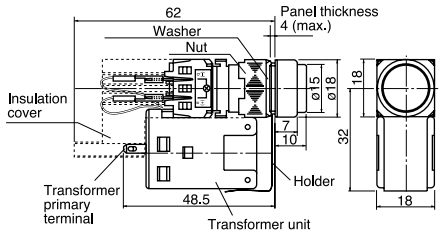
- The color lens is made of a tinted transparent material.
- A white pilot lights is fitted with a transparent color lens. (Except the neon lamp and dome).
- With wire-wrap pin terminals have a depth of 29mm. (Except for ZM type)

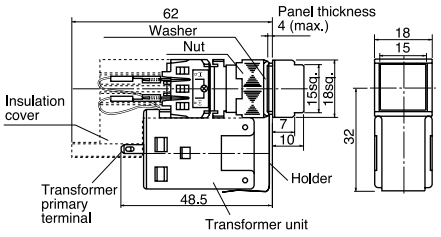
## ■ Pilot lights/with transformer

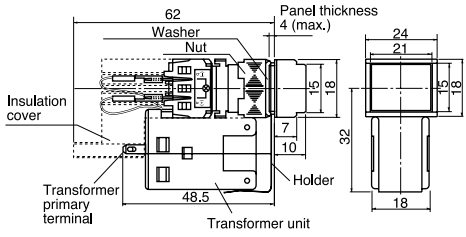
Lens	Lamp	Voltage	AH164 type	AH165 (oil-tight) type	Dimensions, mm
Extended square   AF90-944	Flat LED	■ Voltage H: 100-110V AC  M: 200-220V AC	<b>AH164-Z□■3</b>	<b>AH165-Z□■3</b>	
	Incandescent		<b>AH164-Z□■</b>	<b>AH165-Z□■</b>	
Flush square   AF90-943	Flat LED	■ Voltage H: 100-110V AC  M: 200-220V AC	<b>AH164-ZS□■3</b>	<b>AH165-ZS□■3</b>	
	Incandescent		<b>AH164-ZS□■</b>	<b>AH165-ZS□■</b>	
Flush rectangular   AF90-942	Flat LED	■ Voltage H: 100-110V AC  M: 200-220V AC	<b>AH164-ZT□■3</b>	<b>AH165-ZT□■3</b>	
	Incandescent		<b>AH164-ZT□■</b>	<b>AH165-ZT□■</b>	

### •Lens color

Replace the □ mark by the following lens color code







Color	Green	Red	White	Yellow	Blue	Orange
Code	G	R	W	Y	S	O

- The color lens is made of a tinted transparent material.
- A white pilot lights is fitted with a transparent color lens.

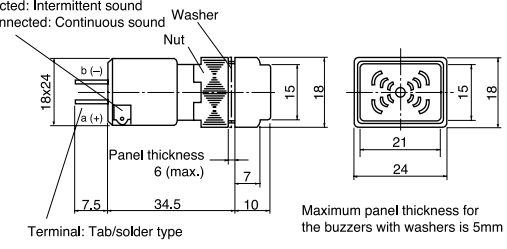
# Buzzers

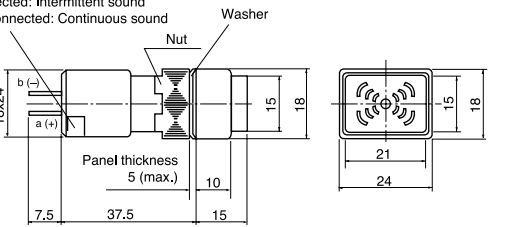
## AH164 and AH165

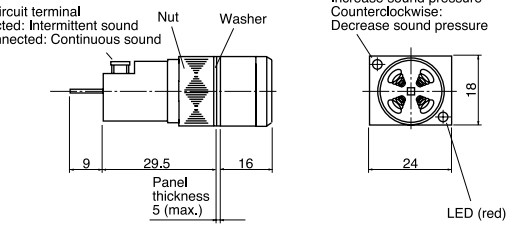
### ■ Buzzers

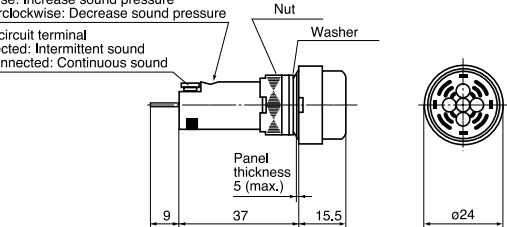
Sound	Operating voltage	Type	Dimensions, mm
<b>Standard</b>   AF87-317	6V AC	<b>AH164-TXBAAC</b>	Short-circuit terminal Connected: Intermittent sound Not connected: Continuous sound  Washer Nut Panel thickness 6 (max.) Terminal: Tab/solder type Maximum panel thickness for the buzzers with washers is 5mm
	6V DC	<b>AH164-TXBADC</b>	
	12 to 24V AC/DC	<b>AH164-TXBE</b>	
	35 to 48V AC/DC	<b>AH164-TXBF</b>	
<b>Loud sound</b>   AF87-44	6V AC	<b>AH164-TX1BAAC</b>	Short-circuit terminal Connected: Intermittent sound Not connected: Continuous sound  Washer Nut Panel thickness 5 (max.) Terminal: Tab/solder type
	6V DC	<b>AH164-TX1BADC</b>	
	12 to 24V AC/DC	<b>AH164-TX1BE</b>	
	35 to 48V AC/DC	<b>AH164-TX1BF</b>	
<b>Loud sound with volume control</b>   AF93-297	6V AC/DC	<b>AH164-TX2BA</b>	Short-circuit terminal Connected: Intermittent sound Not connected: Continuous sound  Washer Nut Panel thickness 5 (max.) LED (red)
	12 to 24V AC/DC	<b>AH164-TX2BE</b>	
	35 to 48V AC/DC	<b>AH164-TX2BF</b>	
<b>Standard sound with volume control (IP54)</b>   AF96-243	6V AC/DC	<b>AH165-XBA</b>	Volume Clockwise: Increase sound pressure Counterclockwise: Decrease sound pressure Short-circuit terminal Connected: Intermittent sound Not connected: Continuous sound  Washer Nut Panel thickness 5 (max.)
	12 to 24V AC/DC	<b>AH165-XBE</b>	
	35 to 48V AC/DC	<b>AH165-XBF</b>	



# Pushbuttons/Selectors/Pilot Lights/Buzzers

## AH164 and AH165

### Mounting space

- Mounting space, mm
- Pushbuttons and pilot lights

#### Extended round head or lens

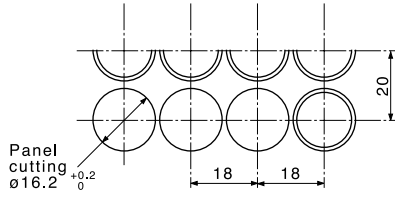

#### Flush square head or lens

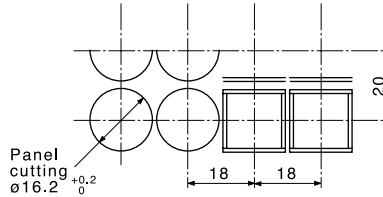

#### Flush rectangular head or lens

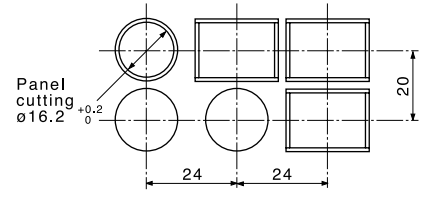

#### Mushroom head

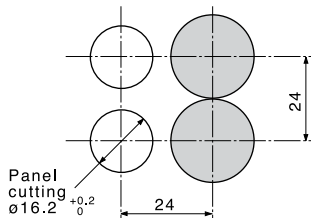

#### Convex square head

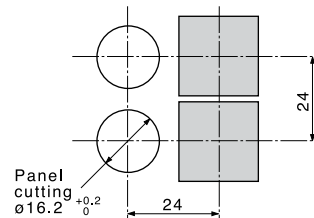

#### Convex rectangular head

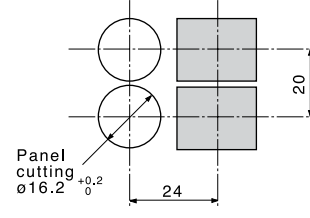

- Selector switches

- When mounting the selector switches near the pilot light

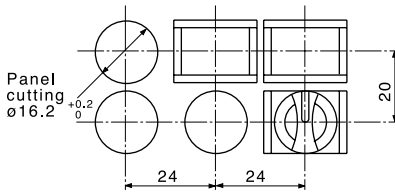

- When mounting the selector switches near each other

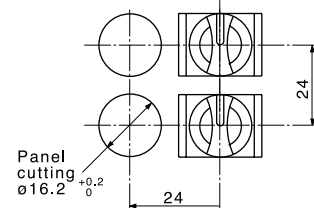

- With transformer

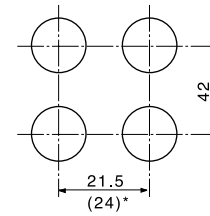

- When mounting the JM or RJM selector switches near each other (2NO+2NC only)

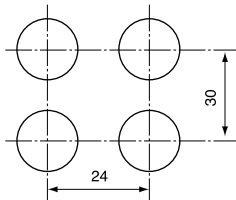

- When mounting the JM or RJM selector switches near the other selector switch, pushbutton switch and pilot lights

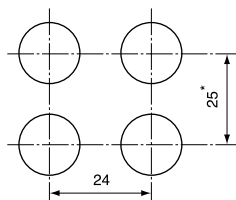

Note: \* Mushroom, convex square, convex rectangular: 27

Note: \* ( ) For switch with flush rectangular head

- AH165-V, V1, V5, V6

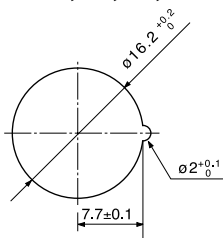

- AH165-JM, RJM

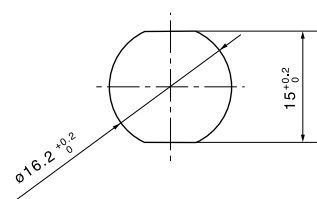

#### ■ Terminal number

##### • AH164, 165

Type	Wiring	Terminal position
Illuminated pushbuttons		Type number display side 
Pushbuttons Selector switches (except for JM, RJM types)		
Pilot lights (without transformer)		Type number display side 

# Pushbuttons/Selectors/Pilot Lights

## AH165-2

### Part number system

#### ■ Part number system

#### Pushbuttons, illuminated pushbuttons and pilot lights

**AH165-2 FL R 11 E 3 - W**  
 ① ② ③ ④ ⑤ ⑥ ⑦

##### ① Product category

AH165-2: Oil-tight (Large operator)

##### ② Operator or lens

• Operator for illuminated pushbutton

- FL: Flush round head
- FL5: Flush round head (Alternate)
- SFL: Flush square head
- SFL5: Flush square head (Alternate)
- EL: Extended round head
- EL5: Extended round head (Alternate)
- SEL: Extended square head
- SEL5: Extended square head (Alternate)
- SCL: Concave square head
- SCL5: Concave square head (Alternate)
- ML: Mushroom head
- YML: Mushroom head with square bezel
- VL: Push-lock, turn-reset
- YVL: Push-lock, turn-reset with square bezel

• Operator for pushbuttons

- F: Flush round head
- F5: Flush round head (Alternate)
- SF: Flush square head
- SF5: Flush square head (Alternate)
- E: Extended round head
- E5: Extended round head (Alternate)
- SE: Extended square head
- SE5: Extended square head (Alternate)
- SCE: Concave square head
- SCE5: Concave square head (Alternate)
- M: Mushroom head
- YM: Mushroom head with square bezel
- V: Push-lock, turn-reset
- YV: Push-lock, turn-reset with square bezel
- S2: With selector ring
- YS2: With selector ring with square bezel

• Lens for pilot lights

- Z: Flush round
- SZ: Flush square
- ZE: Extended round
- SEZ: Extended square

##### ③ Color of button or lens

Code	Color	Button	LED	Incandescent	Neon
G	Green	○	○	○	○
R	Red	○	○	○	○ (Orange)
B	Black*	○	—	—	—
Y	Yellow	○	○	○	○ (Orange)
W	White	○	○ (Orange)	○	○ (Orange)
S	Blue	○	○	○	○ (Green)
O	Orange	○	○ (Amber)	○	○

Notes: • ( ): indicates luminous color  
 \* Not available for illuminated types

##### ④ Contact arrangement (except pilot lights)

- 11: 1NO+1NC
- 22: 2NO+2NC
- 33: 3NO+3NC

##### ⑤ Lamp voltage

Code	LED	Incandescent	Neon
AA	5V DC	—	—
A	6V DC	5V AC/DC	—
B	12V DC	12V AC/DC	—
E	24V DC	24V AC/DC	—
H	—	—	110V AC
K	—	—	120V AC
M	—	—	220V AC
P	—	—	240V AC

##### ⑥ Type of lamp

- Blank: Incandescent
- 1: Neon
- 3: Flat LED

##### ⑦ Terminal

- Blank: Solder/tab
- W: Wire-wrap

# Pushbuttons/Selectors/Pilot Lights

## AH165-2

### Part number system

#### ■ Part number system

##### Selector switches

AH165-2 J 2 B 11 A - W  
 ① ② ③ ④ ⑤ ⑥ ⑦

① **Product category**  
 AH165-2: Oil-tight (Large operator)

② **Operator**  
 • Knob and key type  
 2-position (operating angle 90°)  
 P: Knob  
 YP: Knob with square bezel  
 J: Key  
 YJ: Key with square bezel

3-position (operating angle 45°)  
 P: Knob  
 YP: Knob with square bezel  
 J: Key  
 YJ: Key with square bezel

• Lever type  
 2-position (operating angle 45°)  
 H: Lever  
 SH: Lever with square bezel  
 Note: The operation angle is 45° on the upper and lower side.

③ **Operation**  
 2: 2-position, maintained  
 0: 2-position, spring return\*  
 3: 3-position, maintained  
 6: 3-position, spring/manual return (Left to center)  
 7: 3-position, spring/manual return (Right to center)  
 1: 3-position, spring return  
 Note: \* Except for H and SH types

##### ④ Color of knob, lever or key removable position

• Color of knob or lever  
 B: Black

• Key removable position

Code	2-position		3-position			
	2	0	1	3	6	7
A	↻	↻	—	↻	—	↻
B	⊗	—	—	⊗	—	—
C	—	—	—	⊗	—	—
D	↻	—	—	↻	—	—
E	—	—	↑	—	—	—
F	—	—	—	↻	—	—
G	—	—	—	↻	—	↻

##### ⑤ Contact arrangement

11: 1NO+1NC\*  
 22: 2NO+2NC  
 33: 3NO+3NC  
 Note: \* Except for 3-position

⑥ **Key type No.**  
 A (standard), B, C, D, E, F

⑦ **Terminal**  
 Blank: Solder/tab  
 W: Wire-wrap

##### Illuminated selector switches

AH165-2 PL 2 G 11 E 3  
 ① ② ③ ④ ⑤ ⑥ ⑦

① **Product category**  
 AH165-2: Oil-tight (Large operator)

② **Operator**  
 • 2-position (operating angle 90°)  
 PL: Knob  
 • 3-position (operating angle 45°)  
 PL: Knob

③ **Operation**  
 2: 2-position, maintained  
 3: 3-position, maintained

##### ④ Color of knob

Code	Color	LED	Incandescent	Neon
G	Green	○	○	○
R	Red	○	○	○ (Orange)
Y	Yellow	○	○	○ (Orange)
W	White	○ (Orange)	○	○ (Orange)
S	Blue	○	○	○ (Green)
O	Orange	○ (Amber)	○	○

Notes: • ( ): indicates luminous color  
 • The part other than the arrow of the knob is black.

##### ⑤ Contact arrangement

11: 1NO+1NC\*  
 22: 2NO+2NC  
 Note: \* Except for 3-position

##### ⑥ Lamp voltage

Code	LED	Incandescent	Neon
AA	5V DC	—	—
A	6V DC	5V AC/DC	—
B	12V DC	12V AC/DC	—
E	24V DC	24V AC/DC	—
H	—	—	110V AC
K	—	—	120V AC
M	—	—	220V AC
P	—	—	240V AC

##### ⑦ Type of lamp

Blank: Incandescent  
 1: Neon  
 3: Flat LED  
 Note: Terminal with solder/tab only

# Pushbuttons/Selectors/Pilot Lights

## AH165-2

### Ratings and specifications

#### ■ Standards approved

UL508	File No. E44592
CSA C22.2 No.14	File No. LR20479 (except for AH165-2Z, 2ZE, 2SZ, 2SZE) File No. LR84365 (for AH165-2Z, 2ZE, 2SZ, 2SZE)
TÜV: EN60947-5-1	Pushbutton, illuminated pushbutton: R9250087 Selector (except for AH165-2H, SH), illuminated selector: R9250088 Selector (for AH165-2H, SH): R9250087 Pilot lights: R9250089

#### ■ Specifications (Indoor use)

Item	AH165-2	
Rated insulation voltage	250V AC/DC	
Ambient temperature (no condensation or no icing)	-10 to +70°C *1	
Humidity	45 to 85%RH (at -5 to +40°C), no condensation or no icing	
Durability (operations)	Mechanical	Pushbutton and illuminated pushbutton switch Momentary action: 1 million Alternate action: 250,000 Push-lock, turn-reset: 100,000 With selector ring: 250,000
	Electrical	Selector and illuminated selector switch: 250,000*2 100,000 (220V AC 0.7A)
Dielectric strength	2000V AC, 1 minute (Between lamp and contact terminals: 1500V AC, 1 minute)	
Conditional short-circuit current	1000A	
Short-circuit protective device	Fuse 1A	
Pollution degree	3	
Vibration	Resonance: 10 to 55Hz, double amplitude 0.1mm Constant: 16.7Hz, double amplitude 3mm	
Shock	Malfunction durability: 100m/s <sup>2</sup> Mechanical durability: 500m/s <sup>2</sup>	
Operating frequency	1200 operation/hour (on-load factor: 40%)	
Insulation resistance	100MΩ or more (500V DC megger)	
Operator protection	IP65	

Notes: \*1 For illuminated pushbutton, illuminated selector switch and pilot light: -10 to +55°C

\*2 Key insertion/removal durability for selector switch key types: 10,000

#### ■ Contact ratings

See page 135

#### ■ Lamp ratings

Rated operational voltage	Consumption		
	LED DC	Incandescent AC/DC	Neon AC
5V	14mA (Yellow: 28mA)	0.45W (6V)	—
6V	14mA (Yellow: 28mA)	—	—
12V	14mA	0.55W (14V)	—
24V	14mA	0.55W (28V)	—
110V	—	—	0.19VA
120V	—	—	0.21VA
220V	—	—	0.38VA
240V	—	—	0.42VA

Notes: For the incandescent lamps, the values in parentheses indicate the rated voltage of the lamps.







#### ■ Contact reliability

FUJI has confirmed that the unit can be used in 1mA circuit conditions at 5V AC or DC. The operable range may vary depending on the ambient conditions and type of load.

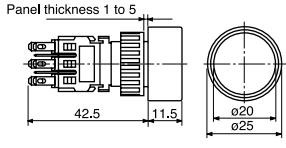
# Illuminated Pushbutton Switches

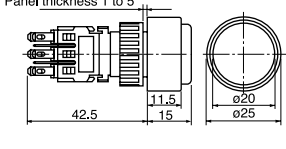

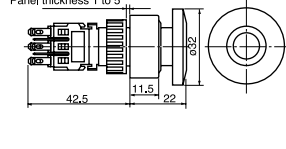

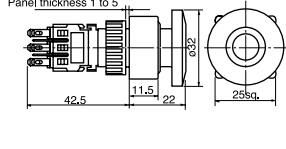
## AH165-2

### ■ Illuminated pushbutton switches

Operator	Lamp	Voltage	Contact	Momentary action	Alternate action	Dimensions, mm		
				Type	Type			
 <p>AF87-211</p>	Flat LED	24V DC	1NO+1NC 2NO+2NC 3NO+3NC	AH165-2FL□11E3 AH165-2FL□22E3 AH165-2FL□33E3	AH165-2FL5□11E3 AH165-2FL5□22E3 AH165-2FL5□33E3			
	Incandescent	24V AC/DC	1NO+1NC 2NO+2NC 3NO+3NC	AH165-2FL□11E AH165-2FL□22E AH165-2FL□33E	AH165-2FL5□11E AH165-2FL5□22E AH165-2FL5□33E			
	Neon	110V AC	1NO+1NC 2NO+2NC 3NO+3NC	AH165-2FL□11H1 AH165-2FL□22H1 AH165-2FL□33H1	AH165-2FL5□11H1 AH165-2FL5□22H1 AH165-2FL5□33H1			
		220V AC	1NO+1NC 2NO+2NC 3NO+3NC	AH165-2FL□11M1 AH165-2FL□22M1 AH165-2FL□33M1	AH165-2FL5□11M1 AH165-2FL5□22M1 AH165-2FL5□33M1			
	 <p>AF87-210</p>	Flat LED	24V DC	1NO+1NC 2NO+2NC 3NO+3NC	AH165-2EL□11E3 AH165-2EL□22E3 AH165-2EL□33E3		AH165-2EL5□11E3 AH165-2EL5□22E3 AH165-2EL5□33E3	
		Incandescent	24V AC/DC	1NO+1NC 2NO+2NC 3NO+3NC	AH165-2EL□11E AH165-2EL□22E AH165-2EL□33E		AH165-2EL5□11E AH165-2EL5□22E AH165-2EL5□33E	
Neon		110V AC	1NO+1NC 2NO+2NC 3NO+3NC	AH165-2EL□11H1 AH165-2EL□22H1 AH165-2EL□33H1	AH165-2EL5□11H1 AH165-2EL5□22H1 AH165-2EL5□33H1			
		220V AC	1NO+1NC 2NO+2NC 3NO+3NC	AH165-2EL□11M1 AH165-2EL□22M1 AH165-2EL□33M1	AH165-2EL5□11M1 AH165-2EL5□22M1 AH165-2EL5□33M1			
 <p>AF87-221</p>		Flat LED	24V DC	1NO+1NC 2NO+2NC 3NO+3NC	AH165-2ML□11E3 AH165-2ML□22E3 AH165-2ML□33E3	— — —		
		Incandescent	24V AC/DC	1NO+1NC 2NO+2NC 3NO+3NC	AH165-2ML□11E AH165-2ML□22E AH165-2ML□33E	— — —		
	Neon	110V AC	1NO+1NC 2NO+2NC 3NO+3NC	AH165-2ML□11H1 AH165-2ML□22H1 AH165-2ML□33H1	— — —			
		220V AC	1NO+1NC 2NO+2NC 3NO+3NC	AH165-2ML□11M1 AH165-2ML□22M1 AH165-2ML□33M1	— — —			
	 <p>AF87-220</p>	Flat LED	24V DC	1NO+1NC 2NO+2NC 3NO+3NC	AH165-2YML□11E3 AH165-2YML□22E3 AH165-2YML□33E3	— — —		
		Incandescent	24V AC/DC	1NO+1NC 2NO+2NC 3NO+3NC	AH165-2YML□11E AH165-2YML□22E AH165-2YML□33E	— — —		
Neon		110V AC	1NO+1NC 2NO+2NC 3NO+3NC	AH165-2YML□11H1 AH165-2YML□22H1 AH165-2YML□33H1	— — —			
		220V AC	1NO+1NC 2NO+2NC 3NO+3NC	AH165-2YML□11M1 AH165-2YML□22M1 AH165-2YML□33M1	— — —			

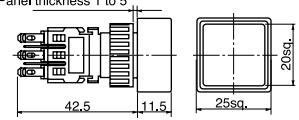
Note: Replace the □ mark by the following color code, see page 157.

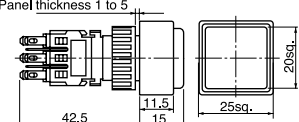

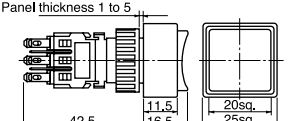
## ■ Illuminated pushbutton switches

Operator	Lamp	Voltage	Contact	Momentary action	Alternate action	Dimensions, mm		
				Type	Type			
 AF87-201	Flat LED	24V DC	1NO+1NC 2NO+2NC 3NO+3NC	AH165-2SFL□11E3 AH165-2SFL□22E3 AH165-2SFL□33E3	AH165-2SFL5□11E3 AH165-2SFL5□22E3 AH165-2SFL5□33E3			
	Incandescent	24V AC/DC	1NO+1NC 2NO+2NC 3NO+3NC	AH165-2SFL□11E AH165-2SFL□22E AH165-2SFL□33E	AH165-2SFL5□11E AH165-2SFL5□22E AH165-2SFL5□33E			
	Neon	110V AC	1NO+1NC 2NO+2NC 3NO+3NC	AH165-2SFL□11H1 AH165-2SFL□22H1 AH165-2SFL□33H1	AH165-2SFL5□11H1 AH165-2SFL5□22H1 AH165-2SFL5□33H1			
		220V AC	1NO+1NC 2NO+2NC 3NO+3NC	AH165-2SFL□11M1 AH165-2SFL□22M1 AH165-2SFL□33M1	AH165-2SFL5□11M1 AH165-2SFL5□22M1 AH165-2SFL5□33M1			
	 AF87-200	Flat LED	24V DC	1NO+1NC 2NO+2NC 3NO+3NC	AH165-2SEL□11E3 AH165-2SEL□22E3 AH165-2SEL□33E3		AH165-2SEL5□11E3 AH165-2SEL5□22E3 AH165-2SEL5□33E3	
		Incandescent	24V AC/DC	1NO+1NC 2NO+2NC 3NO+3NC	AH165-2SEL□11E AH165-2SEL□22E AH165-2SEL□33E		AH165-2SEL5□11E AH165-2SEL5□22E AH165-2SEL5□33E	
Neon		110V AC	1NO+1NC 2NO+2NC 3NO+3NC	AH165-2SEL□11H1 AH165-2SEL□22H1 AH165-2SEL□33H1	AH165-2SEL5□11H1 AH165-2SEL5□22H1 AH165-2SEL5□33H1			
		220V AC	1NO+1NC 2NO+2NC 3NO+3NC	AH165-2SEL□11M1 AH165-2SEL□22M1 AH165-2SEL□33M1	AH165-2SEL5□11M1 AH165-2SEL5□22M1 AH165-2SEL5□33M1			
 AF87-199		Flat LED	24V DC	1NO+1NC 2NO+2NC 3NO+3NC	AH165-2SCL□11E3 AH165-2SCL□22E3 AH165-2SCL□33E3	AH165-2SCL5□11E3 AH165-2SCL5□22E3 AH165-2SCL5□33E3		
		Incandescent	24V AC/DC	1NO+1NC 2NO+2NC 3NO+3NC	AH165-2SCL□11E AH165-2SCL□22E AH165-2SCL□33E	AH165-2SCL5□11E AH165-2SCL5□22E AH165-2SCL5□33E		
	Neon	110V AC	1NO+1NC 2NO+2NC 3NO+3NC	AH165-2SCL□11H1 AH165-2SCL□22H1 AH165-2SCL□33H1	AH165-2SCL5□11H1 AH165-2SCL5□22H1 AH165-2SCL5□33H1			
		220V AC	1NO+1NC 2NO+2NC 3NO+3NC	AH165-2SCL□11M1 AH165-2SCL□22M1 AH165-2SCL□33M1	AH165-2SCL5□11M1 AH165-2SCL5□22M1 AH165-2SCL5□33M1			

Note: Replace the □ mark by the following color code, see page 157.

# Illuminated Pushbutton Switches AH165-2

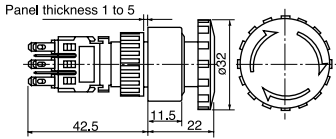
## ■ Illuminated pushbutton switches

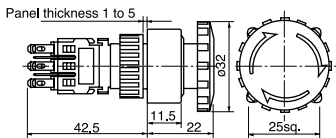
Operator	Lamp	Voltage	Contact	Type	Dimensions, mm		
 <p>AF87-219</p>	Flat LED	24V DC	1NO+1NC 2NO+2NC 3NO+3NC	<b>AH165-2VL□11E3</b> <b>AH165-2VL□22E3</b> <b>AH165-2VL□33E3</b>			
	Incandescent	24V AC/DC	1NO+1NC 2NO+2NC 3NO+3NC	<b>AH165-2VL□11E</b> <b>AH165-2VL□22E</b> <b>AH165-2VL□33E</b>			
	Neon	110V AC	1NO+1NC 2NO+2NC 3NO+3NC	<b>AH165-2VL□11H1</b> <b>AH165-2VL□22H1</b> <b>AH165-2VL□33H1</b>			
		220V AC	1NO+1NC 2NO+2NC 3NO+3NC	<b>AH165-2VL□11M1</b> <b>AH165-2VL□22M1</b> <b>AH165-2VL□33M1</b>			
	 <p>AF87-218</p>	Flat LED	24V DC	1NO+1NC 2NO+2NC 3NO+3NC		<b>AH165-2YVL□11E3</b> <b>AH165-2YVL□22E3</b> <b>AH165-2YVL□33E3</b>	
		Incandescent	24V AC/DC	1NO+1NC 2NO+2NC 3NO+3NC		<b>AH165-2YVL□11E</b> <b>AH165-2YVL□22E</b> <b>AH165-2YVL□33E</b>	
Neon		110V AC	1NO+1NC 2NO+2NC 3NO+3NC	<b>AH165-2YVL□11H1</b> <b>AH165-2YVL□22H1</b> <b>AH165-2YVL□33H1</b>			
		220V AC	1NO+1NC 2NO+2NC 3NO+3NC	<b>AH165-2YVL□11M1</b> <b>AH165-2YVL□22M1</b> <b>AH165-2YVL□33M1</b>			

### • Button color

Replace the □ mark by the following button color code

Color	Green	Red	White	Yellow	Blue	Orange
Code	G	R	W	Y	S	O

• With wire-wrap pin terminals have a depth of 47mm.











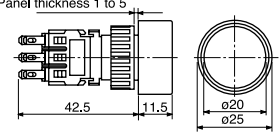

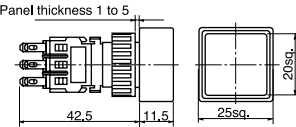
- A white illuminated pushbutton is fitted with a transparent color lens.
- The color lens is made of a tinted transparent material.

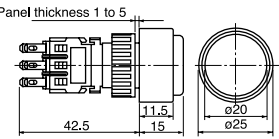
### • Lamp voltage

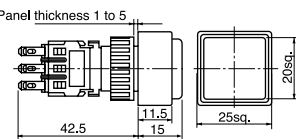
Voltages other than above are available

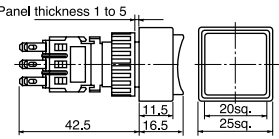
Code	LED	Incandescent	Neon
AA	5V DC	—	—
A	6V DC	5V AC/DC	—
B	12V DC	12V AC/DC	—
K	—	—	120V AC
P	—	—	240V AC

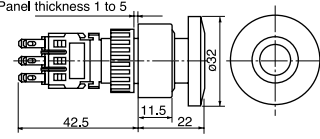
### ■ Pushbutton switches

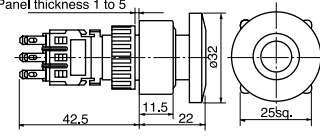
Operator	Contact	Momentary action	Alternate action	Dimensions, mm
		Type	Type	
 <p>AF87-211</p>	1NO+1NC	<b>AH165-2F□11</b>	<b>AH165-2F5□11</b>	Panel thickness 1 to 5 
	2NO+2NC	<b>AH165-2F□22</b>	<b>AH165-2F5□22</b>	
	3NO+3NC	<b>AH165-2F□33</b>	<b>AH165-2F5□33</b>	
 <p>AF87-201</p>	1NO+1NC	<b>AH165-2SF□11</b>	<b>AH165-2SF5□11</b>	Panel thickness 1 to 5 
	2NO+2NC	<b>AH165-2SF□22</b>	<b>AH165-2SF5□22</b>	
	3NO+3NC	<b>AH165-2SF□33</b>	<b>AH165-2SF5□33</b>	
 <p>AF87-210</p>	1NO+1NC	<b>AH165-2E□11</b>	<b>AH165-2E5□11</b>	Panel thickness 1 to 5 
	2NO+2NC	<b>AH165-2E□22</b>	<b>AH165-2E5□22</b>	
	3NO+3NC	<b>AH165-2E□33</b>	<b>AH165-2E5□33</b>	
 <p>AF87-200</p>	1NO+1NC	<b>AH165-2SE□11</b>	<b>AH165-2SE5□11</b>	Panel thickness 1 to 5 
	2NO+2NC	<b>AH165-2SE□22</b>	<b>AH165-2SE5□22</b>	
	3NO+3NC	<b>AH165-2SE□33</b>	<b>AH165-2SE5□33</b>	
 <p>AF87-199</p>	1NO+1NC	<b>AH165-2SCE□11</b>	<b>AH165-2SCE5□11</b>	Panel thickness 1 to 5 
	2NO+2NC	<b>AH165-2SCE□22</b>	<b>AH165-2SCE5□22</b>	
	3NO+3NC	<b>AH165-2SCE□33</b>	<b>AH165-2SCE5□33</b>	
 <p>AF87-215</p>	1NO+1NC	<b>AH165-2M□11</b>	—	Panel thickness 1 to 5 
	2NO+2NC	<b>AH165-2M□22</b>	—	
	3NO+3NC	<b>AH165-2M□33</b>	—	
 <p>AF87-214</p>	1NO+1NC	<b>AH165-2YM□11</b>	—	Panel thickness 1 to 5 
	2NO+2NC	<b>AH165-2YM□22</b>	—	
	3NO+3NC	<b>AH165-2YM□33</b>	—	







Note: Replace the □ mark by the following color code, see page 159.

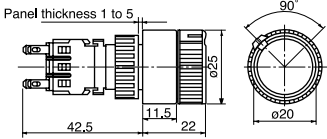

# Pushbutton Switches

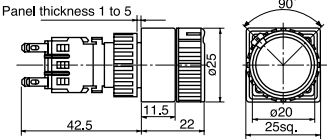
## AH165-2

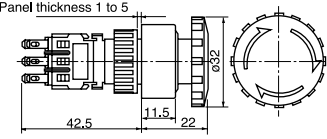
### ■ Pushbutton switches

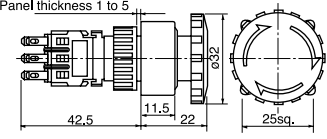
Operator	Contact	Type	Dimensions, mm
With selector ring  AF87-207	2NO+2NC	<b>AH165-2S2□22</b>	
With selector ring with square bezel  AF87-206	2NO+2NC	<b>AH165-2YS2□22</b>	
Push-lock, turn-reset  AF87-210	1NO+1NC 2NO+2NC 3NO+3NC	<b>AH165-2V□11</b> <b>AH165-2V□22</b> <b>AH165-2V□33</b>	
Push-lock, turn-reset with square bezel  AF87-200	1NO+1NC 2NO+2NC 3NO+3NC	<b>AH165-2YV□11</b> <b>AH165-2YV□22</b> <b>AH165-2YV□33</b>	



#### • Button color

Replace the □ mark by the following button color code

Color	Green	Red	Black	White	Blue	Yellow	Orange
Code	G	R	B	W	S	Y	O

#### • Contact arrangement and operator position

AH165-2S, 2YS

Button	Ring	Left	Right
			
Free	U	1○ — 2○ — 1○ — 2○	1○ — 2○ — 1○ — 2○
	L	3○ — 4○ — 3○ — 4○	3○ — 4○ — 3○ — 4○
Depressed	U	1○ — 2○ — 1○ — 2○	1○ — 2○ — 1○ — 2○
	L	3○ — 4○ — 3○ — 4○	3○ — 4○ — 3○ — 4○





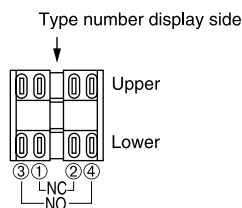

U: Upper contact block  
L: Lower contact block

- The color lens is made of a tinted transparent material. (Except for M, YM, V, YV, types)
- A white pushbutton is fitted with a transparent color lens. A black pushbutton consists of a transparent color lens and an attached black legend plate. (Except for M, YM, V, YV, types)
- With wire-wrap pin terminals have a depth of 47mm.

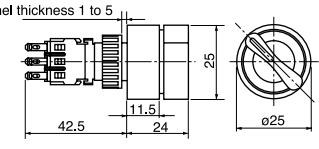
#### • Terminal number and contact block position

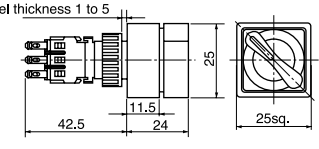

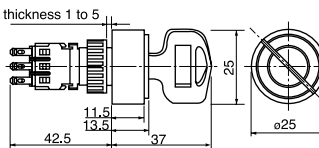
## ■ Selector switches/2-position (90-degree)

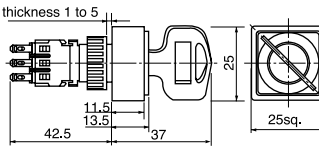
Operator	Operation	Key removable position	Contact	Type	Dimensions, mm
 AF02-111	Maintained	—	1NO+1NC 2NO+2NC 3NO+3NC	<b>AH165-2P2B11</b> <b>AH165-2P2B22</b> <b>AH165-2P2B33</b>	
	Spring return	—	1NO+1NC 2NO+2NC 3NO+3NC	<b>AH165-2P0B11</b> <b>AH165-2P0B22</b> <b>AH165-2P0B33</b>	
 AF02-112	Maintained	—	1NO+1NC 2NO+2NC 3NO+3NC	<b>AH165-2YP2B11</b> <b>AH165-2YP2B22</b> <b>AH165-2YP2B33</b>	
	Spring return	—	1NO+1NC 2NO+2NC 3NO+3NC	<b>AH165-2YP0B11</b> <b>AH165-2YP0B22</b> <b>AH165-2YP0B33</b>	
 AF02-113	Maintained	⊘ A	1NO+1NC 2NO+2NC 3NO+3NC	<b>AH165-2J2A11A</b> <b>AH165-2J2A22A</b> <b>AH165-2J2A33A</b>	
		⊗ B	1NO+1NC 2NO+2NC 3NO+3NC	<b>AH165-2J2B11A</b> <b>AH165-2J2B22A</b> <b>AH165-2J2B33A</b>	
		⊘ D	1NO+1NC 2NO+2NC 3NO+3NC	<b>AH165-2J2D11A</b> <b>AH165-2J2D22A</b> <b>AH165-2J2D33A</b>	
	Spring return	⊘ A	1NO+1NC 2NO+2NC 3NO+3NC	<b>AH165-2J0A11A</b> <b>AH165-2J0A22A</b> <b>AH165-2J0A33A</b>	
		⊗ B	1NO+1NC 2NO+2NC 3NO+3NC	<b>AH165-2YJ2B11A</b> <b>AH165-2YJ2B22A</b> <b>AH165-2YJ2B33A</b>	
		⊘ D	1NO+1NC 2NO+2NC 3NO+3NC	<b>AH165-2YJ2D11A</b> <b>AH165-2YJ2D22A</b> <b>AH165-2YJ2D33A</b>	
 AF02-114	Maintained	⊘ A	1NO+1NC 2NO+2NC 3NO+3NC	<b>AH165-2YJ2A11A</b> <b>AH165-2YJ2A22A</b> <b>AH165-2YJ2A33A</b>	
		⊗ B	1NO+1NC 2NO+2NC 3NO+3NC	<b>AH165-2YJ2B11A</b> <b>AH165-2YJ2B22A</b> <b>AH165-2YJ2B33A</b>	
		⊘ D	1NO+1NC 2NO+2NC 3NO+3NC	<b>AH165-2YJ2D11A</b> <b>AH165-2YJ2D22A</b> <b>AH165-2YJ2D33A</b>	
	Spring return	⊘ A	1NO+1NC 2NO+2NC 3NO+3NC	<b>AH165-2YJ0A11A</b> <b>AH165-2YJ0A22A</b> <b>AH165-2YJ0A33A</b>	
		⊗ B	1NO+1NC 2NO+2NC 3NO+3NC	<b>AH165-2YJ0B11A</b> <b>AH165-2YJ0B22A</b> <b>AH165-2YJ0B33A</b>	
		⊘ D	1NO+1NC 2NO+2NC 3NO+3NC	<b>AH165-2YJ0D11A</b> <b>AH165-2YJ0D22A</b> <b>AH165-2YJ0D33A</b>	

• The key can be removed only at the following positions:

A: ⊘      B: ⊗      D: ⊘

- For spring-return selector switches, the key can be removed at position A.
- There are 6 available key types; A, B, C, D, E and F. Standard key code is A.
- With wire-wrap pin terminals have a depth of 47mm.

### • Terminal number and contact block position

Type number display side

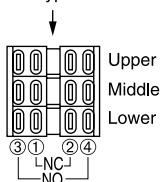

Contact arrangement (terminal No.: common)  
 1NO+1NC: Middle  
 2NO+2NC: Upper, lower  
 3NO+3NC: Upper, middle, lower

### • Contact arrangement and operator positions:

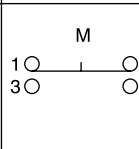
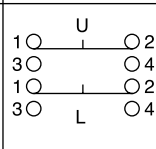
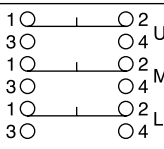
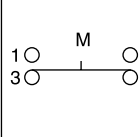
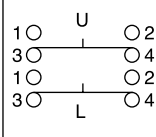
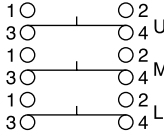

2-position

Contact arrangement		1NO+1NC	2NO+2NC	3NO+3NC
Operator position	Left			
	Right			

U: Upper contact block  
 M: Middle contact block  
 L: Lower contact block

# Selector Switches AH165-2

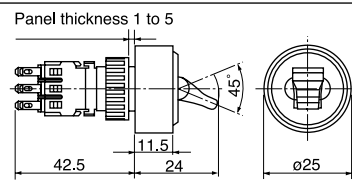
## ■ Selector switches/2-position

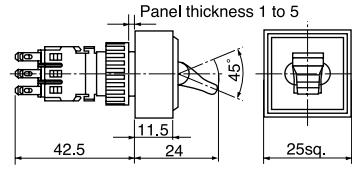
Operator	Lever color	Operation	Contact	Type	Dimensions, mm
 AF87-209	Black	Maintained	1NO+1NC 2NO+2NC 3NO+3NC	AH165-2H2B11 AH165-2H2B22 AH165-2H2B33	
 AF87-203	Black	Maintained	1NO+1NC 2NO+2NC 3NO+3NC	AH165-2SH2B11 AH165-2SH2B22 AH165-2SH2B33	

### • Contact arrangement and operator position

AH165-2H, 2SH

Contact block	Lever	Up	Down
			
1NO+1NC		M 1O   O2 3O — O4	M 1O — O2 3O   O4
2NO+2NC		U                    L 1O   O2 1O   O2 3O — O4 3O — O4	U                    L 1O — O2 1O — O2 3O   O4 3O   O4
3NO+3NC		U                    M                    L 1O   O2 1O   O2 1O   O2 3O — O4 3O — O4 3O — O4	U                    M                    L 1O — O2 1O — O2 1O — O2 3O   O4 3O   O4 3O   O4

U: Upper contact block  
M: Middle contact block  
L: Lower contact block

### • Terminal number and contact block position



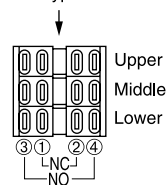



Type number display side

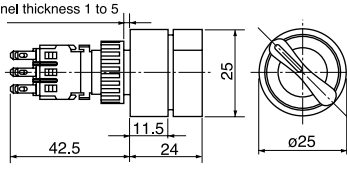

Contact arrangement (terminal No.: common)  
1NO+1NC: Middle  
2NO+2NC: Upper, lower  
3NO+3NC: Upper, middle, lower

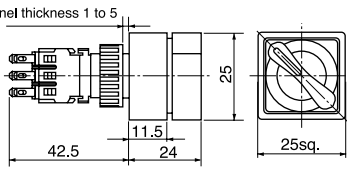
• With wire-wrap pin terminals have a depth of 47mm.

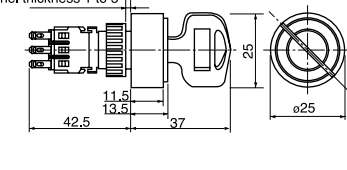
## ■ Selector switches/3-position (45-degree)

Operator	Operation	Key removable position	Contact	Type	Dimensions, mm		
 <p style="text-align: right;">AF87-208</p>	Maintained	—	2NO+2NC 3NO+3NC	<b>AH165-2P3B22</b> <b>AH165-2P3B33</b>			
	Spring/ manual return	—	2NO+2NC 3NO+3NC	<b>AH165-2P6B22</b> <b>AH165-2P6B33</b>			
	Spring/ manual return	—	2NO+2NC 3NO+3NC	<b>AH165-2P7B22</b> <b>AH165-2P7B33</b>			
	Spring return	—	2NO+2NC 3NO+3NC	<b>AH165-2P1B22</b> <b>AH165-2P1B33</b>			
 <p style="text-align: right;">AF87-202</p>	Maintained	—	2NO+2NC 3NO+3NC	<b>AH165-2YP3B22</b> <b>AH165-2YP3B33</b>			
	Spring/ manual return	—	2NO+2NC 3NO+3NC	<b>AH165-2YP6B22</b> <b>AH165-2YP6B33</b>			
	Spring/ manual return	—	2NO+2NC 3NO+3NC	<b>AH165-2YP7B22</b> <b>AH165-2YP7B33</b>			
	Spring return	—	2NO+2NC 3NO+3NC	<b>AH165-2YP1B22</b> <b>AH165-2YP1B33</b>			
 <p style="text-align: right;">AF87-223</p>	Maintained	⊘ A	2NO+2NC 3NO+3NC	<b>AH165-2J3A22A</b> <b>AH165-2J3A33A</b>			
		⊕ E	2NO+2NC 3NO+3NC	<b>AH165-2J3E22A</b> <b>AH165-2J3E33A</b>			
		⊘ D	2NO+2NC 3NO+3NC	<b>AH165-2J3D22A</b> <b>AH165-2J3D33A</b>			
		⊗ C	2NO+2NC 3NO+3NC	<b>AH165-2J3C22A</b> <b>AH165-2J3C33A</b>			
	Spring/ manual return	⊕ E	2NO+2NC 3NO+3NC	<b>AH165-2J6E22A</b> <b>AH165-2J6E33A</b>			
		⊘ D	2NO+2NC 3NO+3NC	<b>AH165-2J6D22A</b> <b>AH165-2J6D33A</b>			
	Spring/ manual return	⊘ A	2NO+2NC 3NO+3NC	<b>AH165-2J7A22A</b> <b>AH165-2J7A33A</b>			
		⊕ E	2NO+2NC 3NO+3NC	<b>AH165-2J7E22A</b> <b>AH165-2J7E33A</b>			
	Spring return	⊕ E	2NO+2NC 3NO+3NC	<b>AH165-2J1E22A</b> <b>AH165-2J1E33A</b>			
		 <p style="text-align: right;">AF87-222</p>	Maintained	⊘ A		2NO+2NC 3NO+3NC	<b>AH165-2YJ3A22A</b> <b>AH165-2YJ3A33A</b>
	⊕ E			2NO+2NC 3NO+3NC		<b>AH165-2YJ3E22A</b> <b>AH165-2YJ3E33A</b>	
	⊘ D			2NO+2NC 3NO+3NC		<b>AH165-2YJ3D22A</b> <b>AH165-2YJ3D33A</b>	
⊗ C	2NO+2NC 3NO+3NC			<b>AH165-2YJ3C22A</b> <b>AH165-2YJ3C33A</b>			
Spring/ manual return	⊕ E		2NO+2NC 3NO+3NC	<b>AH165-2YJ6E22A</b> <b>AH165-2YJ6E33A</b>			
	⊘ D		2NO+2NC 3NO+3NC	<b>AH165-2YJ6D22A</b> <b>AH165-2YJ6D33A</b>			
Spring/ manual return	⊘ A		2NO+2NC 3NO+3NC	<b>AH165-2YJ7A22A</b> <b>AH165-2YJ7A33A</b>			
	⊕ E		2NO+2NC 3NO+3NC	<b>AH165-2YJ7E22A</b> <b>AH165-2YJ7E33A</b>			
Spring return	⊕ E		2NO+2NC 3NO+3NC	<b>AH165-2YJ1E22A</b> <b>AH165-2YJ1E33A</b>			

• The Key can be removed at the following positions:

A: ⊘ B: ⊗ C: ⊗ D: ⊘ E: ⊕ F: ⊕ G: ⊕

For spring-return selector switches, the key can be removed only at position E.  
For manual/spring-return selector switches, the key can be removed at positions D, E and F for type J6, and position A, E and G for type J7.

• There are 6 available key types; A, B, C, D, E and F.  
Standard key code is A.

• With wire-wrap pin terminals have a depth of 47mm.

• Contact arrangement and operator positions:

Contact arrangement		2NO+2NC	3NO+3NC
Operator position	Left	$1 \text{ U } 0 2 \quad 1 0 \text{ L } 0 2$ $3 0 \quad 0 4 \quad 3 0 \text{ L } 0 4$	$1 0 \text{ U } 0 2 \quad 1 0 \text{ M } 0 2 \quad 1 0 \text{ L } 0 2$ $3 0 \quad 0 4 \quad 3 0 \text{ L } 0 4 \quad 3 0 \text{ L } 0 4$
	Center	$1 0 \text{ U } 0 2 \quad 1 0 \text{ L } 0 2$ $3 0 \quad 0 4 \quad 3 0 \quad 0 4$	$1 0 \text{ U } 0 2 \quad 1 0 \text{ L } 0 2 \quad 1 0 \text{ L } 0 2$ $3 0 \quad 0 4 \quad 3 0 \quad 0 4 \quad 3 0 \quad 0 4$
	Right	$1 0 \quad 0 2 \quad 1 0 \text{ L } 0 2$ $3 0 \text{ L } 0 4 \quad 3 0 \quad 0 4$	$1 0 \quad 0 2 \quad 1 0 \quad 0 2 \quad 1 0 \text{ L } 0 2$ $3 0 \text{ L } 0 4 \quad 3 0 \text{ L } 0 4 \quad 3 0 \quad 0 4$

U: Upper contact block    M: Middle contact block    L: Lower contact block

• Contact block positions: See page 161

# Selector Switches

## AH165-2

### ■ Illuminated selector switches

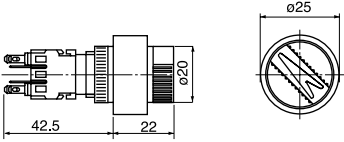
Operator	Operation	Lamp voltage	No. of positions	Contact	Type	Dimensions, mm
 <p>AF90-607</p>	Maintained	Flat LED 24V DC	2	1NO+1NC 2NO+2NC	<b>AH165-2PL2□11E3</b> <b>AH165-2PL2□22E3</b>	
			3	2NO+2NC	<b>AH165-2PL3□22E3</b>	
			2	1NO+1NC 2NO+2NC	<b>AH165-2PL2□11E</b> <b>AH165-2PL2□22E</b>	
		Incandescent 24V AC/DC	3	2NO+2NC	<b>AH165-2PL3□22E</b>	
			2	1NO+1NC 2NO+2NC	<b>AH165-2PL2□11H1</b> <b>AH165-2PL2□22H1</b>	
			3	2NO+2NC	<b>AH165-2PL3□22H1</b>	
		Neon 110V AC	2	1NO+2NC 2NO+2NC	<b>AH165-2PL2□11M1</b> <b>AH165-2PL2□22M1</b>	
			3	2NO+2NC	<b>AH165-2PL3□22M1</b>	
			2	1NO+2NC 2NO+2NC	<b>AH165-2PL2□11M1</b> <b>AH165-2PL2□22M1</b>	
		Neon 220V AC	3	2NO+2NC	<b>AH165-2PL3□22M1</b>	

#### • Knob color (arrow)

Replace the □ mark by the following color code

Color	Green	Red	White	Blue	Yellow	Orange
Code	G	R	W	S	Y	O

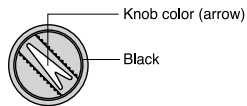

#### • Lamp voltage

Voltages other than above are available

Code	LED	Incandescent	Neon
AA	5V DC	—	—
A	6V DC	5V AC/DC	—
B	12V DC	12V AC/DC	—
K	—	—	120V AC
P	—	—	240V AC

#### • Terminal number and contact block position

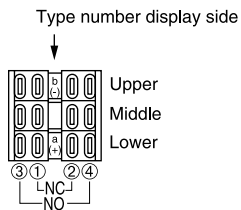

Contact arrangement (terminal No.: common)  
1NO+1NC: Middle  
2NO+2NC: Upper, lower

#### • Contact arrangement and operator positions:

##### 2-position







Contact arrangement	1NO+1NC	2NO+2NC	
Operator position	Left ⊖	M	U L
		Right ⊕	M

##### 3-position

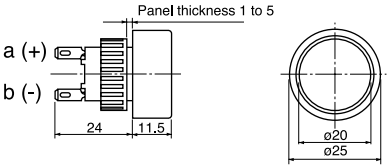
Contact arrangement	2NO+2NC	
Operator position	Left ⊖	U L
	Center ①	U L
Right ⊕	U L	

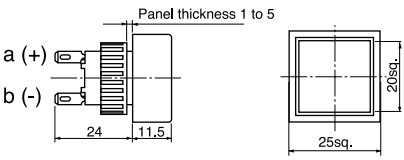
U: Upper contact block  
M: Middle contact block  
L: Lower contact block

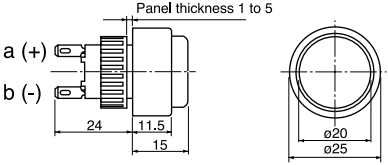
■ Pilot lights

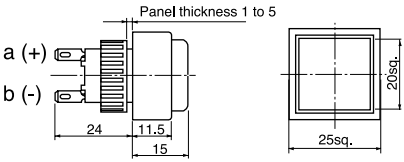
Lens	Lamp	Voltage	Type	Dimensions, mm
 <p>AF87-213</p>	Flat LED	24V DC	<b>AH165-2Z□E3</b>	
	Incandescent	24V AC/DC	<b>AH165-2Z□E</b>	
	Neon	110V AC	<b>AH165-2Z□H1</b>	
		220V AC	<b>AH165-2Z□M1</b>	
 <p>AF87-205</p>	Flat LED	24V DC	<b>AH165-2SZ□E3</b>	
	Incandescent	24V AC/DC	<b>AH165-2SZ□E</b>	
	Neon	110V AC	<b>AH165-2SZ□H1</b>	
		220V AC	<b>AH165-2SZ□M1</b>	
 <p>AF87-212</p>	Flat LED	24V DC	<b>AH165-2ZE□E3</b>	
	Incandescent	24V AC/DC	<b>AH165-2ZE□E</b>	
	Neon	110V AC	<b>AH165-2ZE□H1</b>	
		220V AC	<b>AH165-2ZE□M1</b>	
 <p>AF87-204</p>	Flat LED	24V DC	<b>AH165-2SZE□E3</b>	
	Incandescent	24V AC/DC	<b>AH165-2SZE□E</b>	
	Neon	110V AC	<b>AH165-2SZE□H1</b>	
		220V AC	<b>AH165-2SZE□M1</b>	

• Lens color

Replace the □ mark by the following lens color code

Color	Green	Red	White	Yellow	Blue	Orange
Code	G	R	W	Y	S	O

• Lamp voltage

Voltage other than above is available

Code	LED	Incandescent	Neon
AA	5V DC	—	—
A	6V DC	5V AC/DC	—
B	12V DC	12V AC/DC	—
K	—	—	120V AC
P	—	—	240V AC

- The color lens is made of a tinted transparent material.
- A white lens is fitted with a transparent color lens.
- With wire-wrap pin terminals have a depth of 29mm.

# Pushbuttons/Selectors/Pilot Lights

## AH165-2

### Mounting space

#### ■ Mounting space, mm

- Illuminated pushbuttons, pushbuttons, selector switches, illuminated selector switches and pilot lights

#### Round head

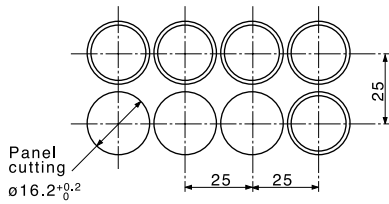

#### Square head

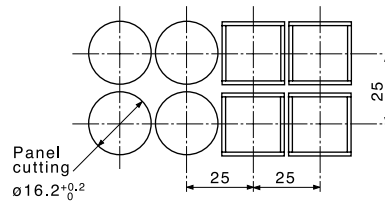

#### Mushroom head Push-lock, turn-reset

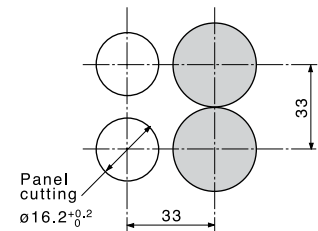

#### ■ Terminal number

Type	Wiring	Terminal position
Illuminated pushbuttons, Illuminated selector switches	<p>a (+)      b (-)</p> <p>① ——— ②</p> <p>③ ○      ○ ④</p>	<p>Type number display side</p>
Pushbuttons Selector switches	<p>① ——— ②</p> <p>③ ○      ○ ④</p>	
Pilot lights (without transformer)	<p>a (+)      b (-)</p> <p>① ——— ②</p> <p>③ ○      ○ ④</p>	<p>Type number display side</p>

# Pushbuttons/Selectors/Pilot Lights/Buzzers

## AH164, AH165 and AH165-2

### Notes on use

#### Notes on use

##### ■ Installation on panel

- For installation, use dedicated wrench AHX601. The appropriate tightening torque is 0.6 to 1N·cm.
- The installation sequence is as follows:  
Pass the operator base through the hole in the panel and secure it by tightening the bezel. Properly position the catch arms of the contact holder and the catch legs of the operator base and push the contact holder onto the operator base. To remove the contact holder, pull it while pressing the catch arms inward.

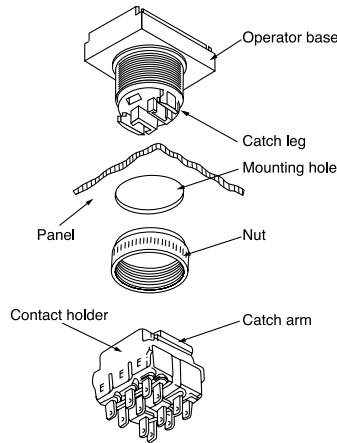

##### ■ Mounting steps of switch with transformer

- ① Pass the switch operator through the panel hole and secure with a nut by way of the retainer metal from the front of the panel.
- ② Align the position of the catch arm of the contact block holder with that of the catch leg of the switch operator. Engage these two catches by pushing them together.
- ③ Insert and secure the transformer unit while assembling the contact block holder with the retainer metal.
- ④ Connect the receptacle terminal with lead wires extending from the transformer to the lamp terminal of the contact block holder. (Be care on the polarity of the LED. Red: +, Black: -)
- ⑤ Push in and secure the standard accessory insulation cover by aligning its position with each terminal. To replace the transformer, remove the transformer by widening the catch leg of the contact block holder. Pay attention not to excessively widen the catch leg. Mounting steps are the same as the above steps ③, ④, and ⑤.

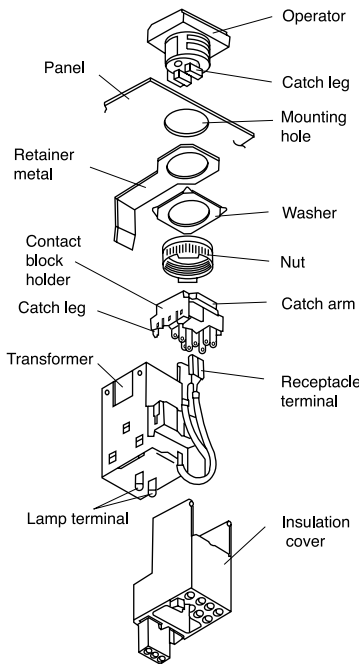

##### ■ Installing the protection cover / dust-tight cover, guarding

- Be careful that the panel thickness does not exceed the following:
- Panel thickness
  - Protection cover: 2.6mm max.
  - Dust-tight cover: 2.0mm max.
  - Guard ring: 2.5mm max.

##### ■ Operating voltage and rated voltage of incandescent lamps

Rated voltage	Operating voltage
6V	4 to 5V
14V	10 to 12V
28V (Standard)	20 to 24V

Incandescent lamps should be operated at the operating voltages if a lamp service life of 5,000 to 10,000 hours are needed. The ambient temperature must not exceed 30°C if the lamp is used at the rated voltage continuously.

##### ■ Method of replacing lamp

- Incandescent lamps/LED lamps/neon lamps  
Remove the color lens and inner button with a remover AHX618.  
Then draw out the lamp with a lamp changer AHX672.  
When installing lamps, do it manually and in the reverse order of removing.
- Products with blue and green LEDs  
The LED devices on products with high-brightness (blue and green) LEDs are very sensitive to static electricity. When replacing LED lamps do not allow static electricity to come into direct contact with the metal frame on the upper side of the LED lamp. The LED device may be damaged if this part is subjected to static electricity. When installing or removing an LED lamp, it is recommended that you use the lamp changer (AHX672).

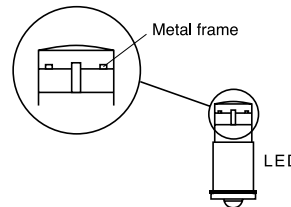

- To replace the lamp of a AH165-2 illuminated pushbutton switch (ML, VL), remove the button and draw out the oil-tight cap.

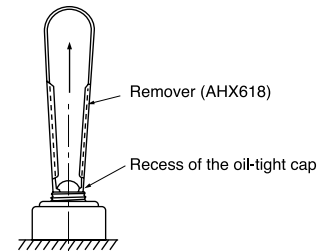

- Then, replace the lamp using a lamp changer (AHX672) and push the oil-tight cap into its original position with its engaging projection properly adjusted (see the figure below).

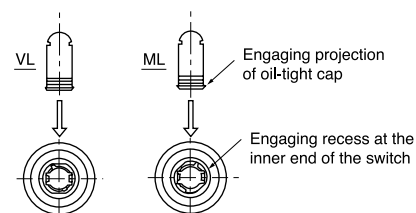

Note: Lamp of AH165-ZM type can not be replaced.



# Pushbuttons/Selectors/Pilot Lights/Buzzers

## AH164, AH165 and AH165-2

### Notes on use

#### ■ Method of replacing color lens

- To remove the color lens, insert a small screwdriver into the color lens and twist in direction of the arrow.

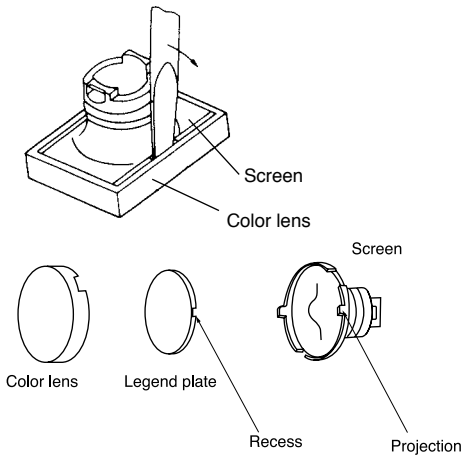

- For an AH165-2, use a small standard screwdriver or a similar tool with a flat end. If one side of the color lens is removed from the screen, insert the screwdriver or a similar tool deeper and remove the color lens together with the screen.

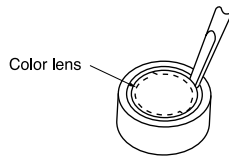

#### ■ Replacing pushbuttons

In the case of alternative action type pushbutton switches and illuminated pushbutton switches, be sure not to replace the pushbuttons in their locked state. This could result in internal damage to the mechanism.

#### ■ Description sheet

The Fuji description sheet is 25 $\mu$ m thick. If preparing custom description sheets, make sure that the thickness is 0.1mm or less.

#### ■ Contact block

To replace a contact block, use removing tool AGX012. If excessive force is applied when attempting to open the support legs for the contact block holder, deformation or damage may occur.

#### ■ Handling precautions

- Do not apply torque in excess of 1.0 N·m to operate the selectors switch (Type "P"). Required operating force of switches is less than 0.1 N·m.
- Do not tap on a pushbutton to turn it ON or OFF, such handling may damage it. Be sure to operate the pushbutton by hand.

#### ■ Key type selector switch

- Five key types (Type B to Type F) are available besides Type A, which is the standard key type.

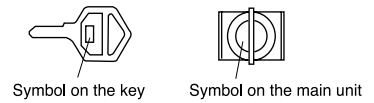

- Be sure to use a key with a symbol which is matched with the symbol on the main unit.
- Fully insert the key into the main unit before turning the key.
- The key turning force should not exceed 0.1 N·m.
- Do not pull out or insert the key forcibly.

#### ■ Wiring connections

- Use a soldering iron with a wattage of not more than 30W and a tip length of more than 20mm. Use a rosin-core solder. With a 30W iron complete soldering within 5 seconds, or 10 seconds with a 20W iron. Do not apply external force to the terminals. Do not deform the terminals. Because lead-free solder's melting point is slightly high, soldering work may be difficult. Use a soldering iron whose tip is rather large or whose calorie is rather high.
- Wires that can be connected
  - Two solid wires with a maximum diameter of 0.8mm (solder)
  - One stranded wire with a maximum area of 0.75mm<sup>2</sup> (solder)
  - Flat connection terminal (2.8□-1.25-5) 0.5 to 1.25mm<sup>2</sup>
  - (2.8□-0.5-5) 0.2 to 0.5mm<sup>2</sup>
- Using contact blocks
  - When using NO and NC contacts in the same contact block, avoid connection that involves opposite polarity or wiring from different types of power supply.
- For wiring to adjacent terminals, use insulated tubing to prevent short-circuit and to assure isolation. For solder terminals, be careful when connecting thick wires. Do not use too much solder.
- Wiring to wire-wrap pin terminals
  - Select the appropriate wire sizes and tools from the table below.

Wire size	Bit	Sleeve	Number of effective wraps
0.4mm dia.	3-A	1-B	About 8
0.5mm dia.	1-A	1-B	About 6
(0.65mm dia.)	(2-A)	(2-B)	(About 6)

Use ordinary wrapping for connection.

Wires of 0.65mm dia. must not be used on adjacent terminals. However, 0.65mm dia. wire can be mixed with 0.4 and 0.5mm dia. wires.

- Wiring to tab terminals
  - Use receptacles, No. 110.

#### ■ Installing lamps in close order

When continuously lighting pilot lights or pressing illuminated pushbuttons installed in close order, care must be taken that the ambient temperature does not exceed the rated value.

# Pushbuttons/Selectors/Pilot Lights/Buzzers

## AH164, AH165 and AH165-2

### Notes on use

#### ■ LEDs

##### • LED Lamp Malfunctioning

The LED lamp is lit by a very small level of current (approximately 0.01mA). Therefore, the it may be erroneously lit by a current leaking from the surge absorption circuit or semiconductor circuit or due to stray capacitance between cables. In that case, provide a countermeasure (e.g., connect a resistor in parallel with the LED lamp).

##### • Countermeasure for Malfunctioning

Shunt Resistor R or CR elements connected in parallel  
Lamp malfunctions can be prevented by connecting a shunt resistor (R) or CR elements (a capacitor and resistor) in parallel with the LED lamp terminal. The resistance and CR values vary depending on the model and the operating conditions.

Example 1

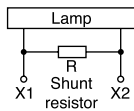

- 24V DC
- R: 10k $\Omega$  (1W)

Example 2

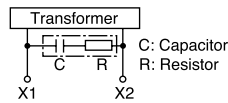

- 110V AC
- C: 0.33 $\mu$ F (250V AC)
- R: 120 $\Omega$  (0.25W)
- 220V AC
- C: 0.33 $\mu$ F (250V AC)
- R: 120 $\Omega$  (0.25W)

##### • Incoming surge

Be careful that since high luminance LED products use an element sensitive to static electricity, they may not be lit by an abnormal voltage like surge.

#### ■ Using a flat LED in 48V DC circuit

When a flat LED lamps having a rated voltage of 24V DC is used with 48V DC circuit, connect an external resistor of 1,800 $\Omega$  (2W).

#### ■ Preventing the neon lamp from incorrectly turning ON

The neon lamp may incorrectly turn ON due to current leakage or voltage induction. In such a case, connect a shunt resistor in parallel with the lamp.

Example) 110V AC: 100k $\Omega$  (0.25W)  
220V AC: 50k $\Omega$  (2W)

If an external surge of 3kV or more may occur, connect a surge absorption element in parallel with the lamp.

#### ■ Numerical indicators

To ensure high reliability and long life for the LED, design the circuit not to exceed the maximum ratings under any operating conditions.

- Keep in mind that the display may malfunction or be damaged due to noise in input signals. (TC type)
- Wire the TC type as shown on the nameplate. The IC may break if the supply voltage is connected in reverse.
- Keep in mind that the correct display will not appear with negative logic input because the TC type accepts positive logic input.

#### ■ Operation

Do not use a hitting or bouncing action to operate the button, or the switch may break. Always operate the switch by hand.

#### ■ Storage and operation site

- Use the unit within the rated operating ambient temperature and humidity ranges.
- Do not use the enclosed type in places where oil or water is sprayed or where dust accumulates. In places such as these, use the oil-tight type or provide a dust cover.
- The oil-tight type is evaluated with standard cutting oil and cooling oil applied. The oil-tight type cannot be used with some special oils.

#### ■ Buzzer

##### • Noise

If the application circuit is likely to generate excessively strong noise, connect a surge absorber (e.g., FUJI'S ENC390D, provided that the switch is a 24V type) in parallel with the buzzer.







##### • Place of Use





The buzzer does not have a drip-proof construction. Do not use the buzzer in places where oil or water is sprayed or where dust accumulates. If the buzzer is a splash-proof type, it will resist sprays of water.

- Do not use the buzzer in places that are subject to an excessive amount of corrosive gas.
- Be careful that the buzzer is likely to sound erroneously due to leakage current or the like.

# Pushbuttons/Selectors/Pilot Lights/Buzzers AH164 and AH165 Accessories

## ■ Accessories for AH164 and AH165

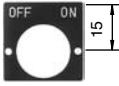



Description	Type	
Color chips (Round)	Color	Type
 <p>L, L5, E E5, Z</p>	Green	<b>AHX631-G</b>
	Red	<b>AHX631-R</b>
	White (For Neon)	<b>AHX631-W</b>
	Blue	<b>AHX631-S</b>
	Yellow	<b>AHX631-Y</b>
	Orange	<b>AHX631-O</b>
	Clear	<b>AHX631-C</b>
SF-682 For LED, Neon	Green	<b>AHX653-G</b>
Color chips (Square)	Color	Type
 <p>SL, SL5, SGL, SGL5, SF, SF5, SGF, SGF5, ZS</p>	Green	<b>AHX632-G</b>
	Red	<b>AHX632-R</b>
	White (For Neon)	<b>AHX632-W</b>
	Blue	<b>AHX632-S</b>
	Yellow	<b>AHX632-Y</b>
	Orange	<b>AHX632-O</b>
	Clear	<b>AHX632-C</b>
SF-681 For LED, Neon	Green	<b>AHX653-SG</b>
Color chips (Rectangular)	Color	Type
 <p>TL, TL5, TGL TGL5, TF, TF5 TGF, TGF5, ZT</p>	Green	<b>AHX633-G</b>
	Red	<b>AHX633-R</b>
	White (For Neon)	<b>AHX633-W</b>
	Blue	<b>AHX633-S</b>
	Yellow	<b>AHX633-Y</b>
	Orange	<b>AHX633-O</b>
	Clear	<b>AHX633-C</b>
SF-680 For LED, Neon	Green	<b>AHX653-TG</b>
Mushroom head button	Color	Type
 <p>M, M5</p>	Green	<b>AHX682-G</b>
	Red	<b>AHX682-R</b>
	White	<b>AHX682-W</b>
	Blue	<b>AHX682-S</b>
	Yellow	<b>AHX682-Y</b>
	Orange	<b>AHX682-O</b>
	Black	<b>AHX682-B</b>
SI-40		
Convex square head button	Color	Type
 <p>SM, SM5</p>	Green	<b>AHX683-G</b>
	Red	<b>AHX683-R</b>
	White	<b>AHX683-W</b>
	Blue	<b>AHX683-S</b>
	Yellow	<b>AHX683-Y</b>
	Orange	<b>AHX683-O</b>
	Black	<b>AHX683-B</b>
SI-43		
Convex rectangular head button	Color	Type
 <p>TM, TM5</p>	Green	<b>AHX684-G</b>
	Red	<b>AHX684-R</b>
	White	<b>AHX684-W</b>
	Blue	<b>AHX684-S</b>
	Yellow	<b>AHX684-Y</b>
	Orange	<b>AHX684-O</b>
	Black	<b>AHX684-B</b>
SI-44		

Description	Type	
Legend sheet	Round	Type: <b>AHX615-□</b> Legend: ON, OFF, UP, DOWN
	Square	Type: <b>AHX616-□</b> Legend: ON, OFF, UP, DOWN START, STOP, OPEN CLOSE, AUTO, MAN, RESET, POWER, REV, FWD, HIGH, LOW
	Rectangular	Type: <b>AHX617-□</b> Legend: ON, OFF, UP, DOWN START, STOP, AUTO, MAN, FOWARD, REVERSE
	When ordering, specify desired legend in the □ at the end of ordering code, Transparent blank sheets are also available. Use black oil ink.	
SH-165		
Legend plate (Acrylic resin)	Type	Color Dimensions, mm
	Round	<b>AHX665</b> White $\phi 12.2 \times 0.9$ <b>AHX665-C</b> Transparent <b>AHX665-B</b> Black
	Square	<b>AHX666</b> White 12.2sq. x 0.9 <b>AHX666-C</b> Transparent <b>AHX666-B</b> Black
	Rectangular	<b>AHX667</b> White 12.2 x 18.2 x 0.9 <b>AHX667-C</b> Transparent <b>AHX667-B</b> Black
SH-164		
Legend plate for spot LED (Acrylic resin)	Type	Dimensions, mm
	Round	<b>AHX650</b> $\phi 12.2 \times 0.9$
	Square	<b>AHX651</b> 12.2sq. x 0.9
	Rectangular	<b>AHX652</b> 12.2 x 18.2 x 0.9
SP-113		
Legend plate for selector switch (2-position)	Type: <b>AHX664</b>	Legend: ON-OFF Legend: Blank
	Dimensions, mm: 24sq. x 0.5	
	SH-226A	
Legend plate for symbol mark	Mark	Type
	Square ○	<b>AHX666-E</b> <b>AHX667-E</b>
	Rectangular I	<b>AHX666-H</b> <b>AHX667-H</b>
	Rectangular ⊕	<b>AHX666-T</b> <b>AHX667-T</b>
AF87-74		

# Pushbuttons/Selectors/Pilot Lights/Buzzers

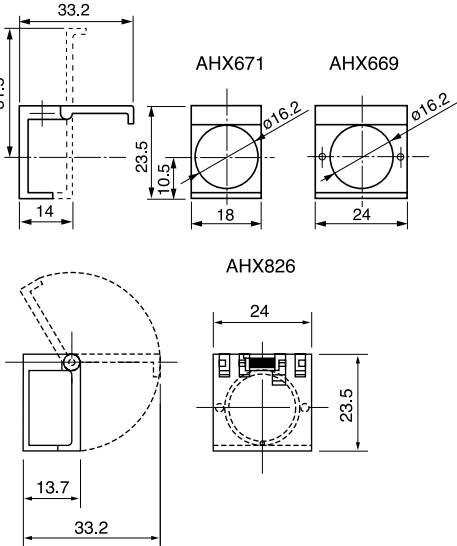
## AH164 and AH165

### Accessories

Description	Type															
<p>Protection cover</p>  <p>SM-378</p>	<p>For round and square head button Type: <b>AHX671</b></p> <p>For rectangular head button Type: <b>AHX669</b> <b>AHX826</b></p> <p>This cover protect against accidental operation. Note: Not used for illuminated pushbuttons with guard. Applicable panel thickness is 2.6mm max.</p> <p>Dimensions, mm</p> 															
<p>Dust-tight cover</p>  <p>AF91-123, SI-41</p>	<p>For round and square head button Type: <b>AHX822</b> Dimensions, mm: 24sq. x 14.2</p> <p>For rectangular head button Type: <b>AHX668</b> Dimensions, mm: 24 x 30 x 14.2</p> <p>For mushroom head button Type: <b>AHX649</b> Dimensions, mm: <math>\varnothing 30</math> x 18</p> <p>These covers protect against dust. Note: Applicable panel thickness is 2.0mm max.</p>															
<p>Guard ring</p>  <p>SI-42</p>	<table border="1"> <thead> <tr> <th>Type</th> <th>Color</th> <th>Dimensions, mm</th> </tr> </thead> <tbody> <tr> <td><b>AHX676-B</b></td> <td>Black</td> <td><math>\varnothing 21</math> x 12</td> </tr> <tr> <td><b>AHX676-GY</b></td> <td>Gray</td> <td></td> </tr> </tbody> </table> <p>This guard ring is used in combination with an extended round head pushbutton (L or E).</p> <p>Note: Applicable panel thickness is 2.5mm max. Please place an order for a packing (AHX685) separately when you intend to use for AH165 series.</p>	Type	Color	Dimensions, mm	<b>AHX676-B</b>	Black	$\varnothing 21$ x 12	<b>AHX676-GY</b>	Gray							
Type	Color	Dimensions, mm														
<b>AHX676-B</b>	Black	$\varnothing 21$ x 12														
<b>AHX676-GY</b>	Gray															
<p>Transformer</p>  <p>AF90-949</p>	<table border="1"> <thead> <tr> <th>Voltage</th> <th>Type</th> <th>Lamp</th> </tr> </thead> <tbody> <tr> <td>100 to 110V AC</td> <td><b>AHX805-H</b></td> <td>LED</td> </tr> <tr> <td>200 to 220V AC</td> <td><b>AHX805-M</b></td> <td></td> </tr> <tr> <td>100 to 110V AC</td> <td><b>AHX806-H</b></td> <td>Incandescent</td> </tr> <tr> <td>200 to 220V AC</td> <td><b>AHX806-M</b></td> <td></td> </tr> </tbody> </table>	Voltage	Type	Lamp	100 to 110V AC	<b>AHX805-H</b>	LED	200 to 220V AC	<b>AHX805-M</b>		100 to 110V AC	<b>AHX806-H</b>	Incandescent	200 to 220V AC	<b>AHX806-M</b>	
Voltage	Type	Lamp														
100 to 110V AC	<b>AHX805-H</b>	LED														
200 to 220V AC	<b>AHX805-M</b>															
100 to 110V AC	<b>AHX806-H</b>	Incandescent														
200 to 220V AC	<b>AHX806-M</b>															

# Pushbuttons/Selectors/Pilot Lights/Buzzers

## AH165-2





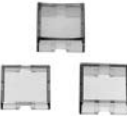
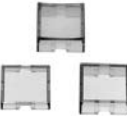
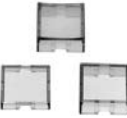
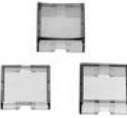



### Accessories

#### ■ Accessories for AH165-2

Description	Type													
Color lens (Round)  	For flush head (Used with 2F, 2F5, 2FL, 2FL5, 2Z)													
	<table border="0"> <tr><td>Color</td><td>Type</td></tr> <tr><td>Green</td><td><b>AHX2604-G</b></td></tr> <tr><td>Red</td><td><b>AHX2604-R</b></td></tr> <tr><td>Yellow</td><td><b>AHX2604-Y</b></td></tr> <tr><td>Blue</td><td><b>AHX2604-S</b></td></tr> <tr><td>Orange</td><td><b>AHX2604-O</b></td></tr> <tr><td>Clear</td><td><b>AHX2604-C</b></td></tr> </table>	Color	Type	Green	<b>AHX2604-G</b>	Red	<b>AHX2604-R</b>	Yellow	<b>AHX2604-Y</b>	Blue	<b>AHX2604-S</b>	Orange	<b>AHX2604-O</b>	Clear
Color	Type													
Green	<b>AHX2604-G</b>													
Red	<b>AHX2604-R</b>													
Yellow	<b>AHX2604-Y</b>													
Blue	<b>AHX2604-S</b>													
Orange	<b>AHX2604-O</b>													
Clear	<b>AHX2604-C</b>													
Color lens (Square)  	For flush head (Used with 2SF, 2SF5, 2SFL, 2SFL5, 2SZ)													
	<table border="0"> <tr><td>Color</td><td>Type</td></tr> <tr><td>Green</td><td><b>AHX2606-G</b></td></tr> <tr><td>Red</td><td><b>AHX2606-R</b></td></tr> <tr><td>Yellow</td><td><b>AHX2606-Y</b></td></tr> <tr><td>Blue</td><td><b>AHX2606-S</b></td></tr> <tr><td>Orange</td><td><b>AHX2606-O</b></td></tr> <tr><td>Clear</td><td><b>AHX2606-C</b></td></tr> </table>	Color	Type	Green	<b>AHX2606-G</b>	Red	<b>AHX2606-R</b>	Yellow	<b>AHX2606-Y</b>	Blue	<b>AHX2606-S</b>	Orange	<b>AHX2606-O</b>	Clear
Color	Type													
Green	<b>AHX2606-G</b>													
Red	<b>AHX2606-R</b>													
Yellow	<b>AHX2606-Y</b>													
Blue	<b>AHX2606-S</b>													
Orange	<b>AHX2606-O</b>													
Clear	<b>AHX2606-C</b>													
	For extended head (Used with 2E, 2E5, 2EL, 2EL5, 2ZE)													
	<table border="0"> <tr><td>Color</td><td>Type</td></tr> <tr><td>Green</td><td><b>AHX2605-G</b></td></tr> <tr><td>Red</td><td><b>AHX2605-R</b></td></tr> <tr><td>Yellow</td><td><b>AHX2605-Y</b></td></tr> <tr><td>Blue</td><td><b>AHX2605-S</b></td></tr> <tr><td>Orange</td><td><b>AHX2605-O</b></td></tr> <tr><td>Clear</td><td><b>AHX2605-C</b></td></tr> </table>	Color	Type	Green	<b>AHX2605-G</b>	Red	<b>AHX2605-R</b>	Yellow	<b>AHX2605-Y</b>	Blue	<b>AHX2605-S</b>	Orange	<b>AHX2605-O</b>	Clear
Color	Type													
Green	<b>AHX2605-G</b>													
Red	<b>AHX2605-R</b>													
Yellow	<b>AHX2605-Y</b>													
Blue	<b>AHX2605-S</b>													
Orange	<b>AHX2605-O</b>													
Clear	<b>AHX2605-C</b>													
	For extended head (Used with 2SE, 2SE5, 2SEL, 2SEL5, 2SZE)													
	<table border="0"> <tr><td>Color</td><td>Type</td></tr> <tr><td>Green</td><td><b>AHX2607-G</b></td></tr> <tr><td>Red</td><td><b>AHX2607-R</b></td></tr> <tr><td>Yellow</td><td><b>AHX2607-Y</b></td></tr> <tr><td>Blue</td><td><b>AHX2607-S</b></td></tr> <tr><td>Orange</td><td><b>AHX2607-O</b></td></tr> <tr><td>Clear</td><td><b>AHX2607-C</b></td></tr> </table>	Color	Type	Green	<b>AHX2607-G</b>	Red	<b>AHX2607-R</b>	Yellow	<b>AHX2607-Y</b>	Blue	<b>AHX2607-S</b>	Orange	<b>AHX2607-O</b>	Clear
Color	Type													
Green	<b>AHX2607-G</b>													
Red	<b>AHX2607-R</b>													
Yellow	<b>AHX2607-Y</b>													
Blue	<b>AHX2607-S</b>													
Orange	<b>AHX2607-O</b>													
Clear	<b>AHX2607-C</b>													
	For concave head (Used with 2SCE, 2SCE5, 2SCL, 2SCL5)													
	<table border="0"> <tr><td>Color</td><td>Type</td></tr> <tr><td>Green</td><td><b>AHX2608-G</b></td></tr> <tr><td>Red</td><td><b>AHX2608-R</b></td></tr> <tr><td>Yellow</td><td><b>AHX2608-Y</b></td></tr> <tr><td>Blue</td><td><b>AHX2608-S</b></td></tr> <tr><td>Orange</td><td><b>AHX2608-O</b></td></tr> <tr><td>Clear</td><td><b>AHX2608-C</b></td></tr> </table>	Color	Type	Green	<b>AHX2608-G</b>	Red	<b>AHX2608-R</b>	Yellow	<b>AHX2608-Y</b>	Blue	<b>AHX2608-S</b>	Orange	<b>AHX2608-O</b>	Clear
Color	Type													
Green	<b>AHX2608-G</b>													
Red	<b>AHX2608-R</b>													
Yellow	<b>AHX2608-Y</b>													
Blue	<b>AHX2608-S</b>													
Orange	<b>AHX2608-O</b>													
Clear	<b>AHX2608-C</b>													

AF87-631

AF87-632

Description	Type															
Legend plate  	For flush head															
	<table border="0"> <tr><td>Color</td><td>Type</td><td>Used with</td></tr> <tr><td>White</td><td><b>AHX2609-W</b></td><td>Incandescent lamp, LED lamp, Pushbutton *1</td></tr> <tr><td>Clear</td><td><b>AHX2609-C</b></td><td>Neon lamp *2</td></tr> <tr><td>Black</td><td><b>AHX2609-B</b></td><td>Pushbutton *3</td></tr> </table> <p>Dimensions, mm: <math>\phi 18 \times 0.9</math></p>	Color	Type	Used with	White	<b>AHX2609-W</b>	Incandescent lamp, LED lamp, Pushbutton *1	Clear	<b>AHX2609-C</b>	Neon lamp *2	Black	<b>AHX2609-B</b>	Pushbutton *3			
Color	Type	Used with														
White	<b>AHX2609-W</b>	Incandescent lamp, LED lamp, Pushbutton *1														
Clear	<b>AHX2609-C</b>	Neon lamp *2														
Black	<b>AHX2609-B</b>	Pushbutton *3														
	For extended head															
	<table border="0"> <tr><td>Color</td><td>Type</td><td>Used with</td></tr> <tr><td>White</td><td><b>AHX2610-W</b></td><td>Incandescent lamp, LED lamp, Pushbutton *1</td></tr> <tr><td>Clear</td><td><b>AHX2610-C</b></td><td>Neon lamp *2</td></tr> <tr><td>Black</td><td><b>AHX2610-B</b></td><td>Pushbutton *3</td></tr> </table> <p>Dimensions, mm: <math>\phi 18 \times 4.4</math></p>	Color	Type	Used with	White	<b>AHX2610-W</b>	Incandescent lamp, LED lamp, Pushbutton *1	Clear	<b>AHX2610-C</b>	Neon lamp *2	Black	<b>AHX2610-B</b>	Pushbutton *3			
Color	Type	Used with														
White	<b>AHX2610-W</b>	Incandescent lamp, LED lamp, Pushbutton *1														
Clear	<b>AHX2610-C</b>	Neon lamp *2														
Black	<b>AHX2610-B</b>	Pushbutton *3														
	For flush square															
	<table border="0"> <tr><td>Color</td><td>Type</td><td>Used with</td></tr> <tr><td>White</td><td><b>AHX2611-W</b></td><td>Incandescent lamp, LED lamp, Pushbutton *1</td></tr> <tr><td>Clear</td><td><b>AHX2611-C</b></td><td>Neon lamp *2</td></tr> <tr><td>Black</td><td><b>AHX2611-B</b></td><td>Pushbutton *3</td></tr> </table> <p>Dimensions, mm: 17sq. x 0.9</p>	Color	Type	Used with	White	<b>AHX2611-W</b>	Incandescent lamp, LED lamp, Pushbutton *1	Clear	<b>AHX2611-C</b>	Neon lamp *2	Black	<b>AHX2611-B</b>	Pushbutton *3			
Color	Type	Used with														
White	<b>AHX2611-W</b>	Incandescent lamp, LED lamp, Pushbutton *1														
Clear	<b>AHX2611-C</b>	Neon lamp *2														
Black	<b>AHX2611-B</b>	Pushbutton *3														
	For extended square, concave square															
	<table border="0"> <tr><td>Color</td><td>Type</td><td>Used with</td></tr> <tr><td>White</td><td><b>AHX2612-W</b></td><td>Incandescent lamp, LED lamp, Pushbutton *1</td></tr> <tr><td>Clear</td><td><b>AHX2612-C</b></td><td>Neon lamp *2</td></tr> <tr><td>Black</td><td><b>AHX2612-B</b></td><td>Pushbutton *3</td></tr> </table> <p>Dimensions, mm: 17sq. x 4.4</p>	Color	Type	Used with	White	<b>AHX2612-W</b>	Incandescent lamp, LED lamp, Pushbutton *1	Clear	<b>AHX2612-C</b>	Neon lamp *2	Black	<b>AHX2612-B</b>	Pushbutton *3			
Color	Type	Used with														
White	<b>AHX2612-W</b>	Incandescent lamp, LED lamp, Pushbutton *1														
Clear	<b>AHX2612-C</b>	Neon lamp *2														
Black	<b>AHX2612-B</b>	Pushbutton *3														
																
	<p>*1 Illuminated pushbutton switches and pilot lights with incandescent lamps or LED lamps, Pushbutton switches (excluding).</p> <p>*2 Illuminated pushbutton switches and pilot lights with neon lamps.</p> <p>*3 Pushbutton switches (black)</p> <p>*4 Engraved range: 17mm dia.</p>															
Mushroom head button  	For illuminated pushbuttons (Used with 2ML, 2YML)															
	<table border="0"> <tr><td>Color</td><td>Type</td></tr> <tr><td>Green</td><td><b>AHX2614-G</b></td></tr> <tr><td>Red</td><td><b>AHX2614-R</b></td></tr> <tr><td>White</td><td><b>AHX2614-W</b></td></tr> <tr><td>Yellow</td><td><b>AHX2614-Y</b></td></tr> <tr><td>Blue</td><td><b>AHX2614-S</b></td></tr> <tr><td>Orange</td><td><b>AHX2614-O</b></td></tr> </table>	Color	Type	Green	<b>AHX2614-G</b>	Red	<b>AHX2614-R</b>	White	<b>AHX2614-W</b>	Yellow	<b>AHX2614-Y</b>	Blue	<b>AHX2614-S</b>	Orange	<b>AHX2614-O</b>	
	Color	Type														
Green	<b>AHX2614-G</b>															
Red	<b>AHX2614-R</b>															
White	<b>AHX2614-W</b>															
Yellow	<b>AHX2614-Y</b>															
Blue	<b>AHX2614-S</b>															
Orange	<b>AHX2614-O</b>															
	For non-illuminated pushbuttons (Used with 2M, 2YM)															
	<table border="0"> <tr><td>Color</td><td>Type</td></tr> <tr><td>Green</td><td><b>AHX2613-G</b></td></tr> <tr><td>Red</td><td><b>AHX2613-R</b></td></tr> <tr><td>White</td><td><b>AHX2613-W</b></td></tr> <tr><td>Yellow</td><td><b>AHX2613-Y</b></td></tr> <tr><td>Blue</td><td><b>AHX2613-S</b></td></tr> <tr><td>Orange</td><td><b>AHX2613-O</b></td></tr> <tr><td>Black</td><td><b>AHX2613-B</b></td></tr> </table>	Color	Type	Green	<b>AHX2613-G</b>	Red	<b>AHX2613-R</b>	White	<b>AHX2613-W</b>	Yellow	<b>AHX2613-Y</b>	Blue	<b>AHX2613-S</b>	Orange	<b>AHX2613-O</b>	Black
Color	Type															
Green	<b>AHX2613-G</b>															
Red	<b>AHX2613-R</b>															
White	<b>AHX2613-W</b>															
Yellow	<b>AHX2613-Y</b>															
Blue	<b>AHX2613-S</b>															
Orange	<b>AHX2613-O</b>															
Black	<b>AHX2613-B</b>															



AF87-631  
AF87-630

AF87-633

# Pushbuttons/Selectors/Pilot Lights/Buzzers



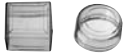

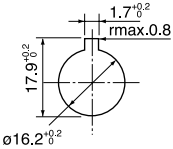

## AH165-2





### Accessories

Description	Type																				
<p data-bbox="120 317 326 365">Push-lock, turn-reset button</p>  <p data-bbox="112 743 175 758">AF87-634</p>	<p data-bbox="342 317 623 365">For illuminated pushbuttons (Used with 2VL, 2YVL)</p> <table data-bbox="370 373 623 506"> <tr> <td>Color</td> <td>Type</td> </tr> <tr> <td>Green</td> <td><b>AHX2616-G</b></td> </tr> <tr> <td>Red</td> <td><b>AHX2616-R</b></td> </tr> <tr> <td>White</td> <td><b>AHX2616-W</b></td> </tr> <tr> <td>Yellow</td> <td><b>AHX2616-Y</b></td> </tr> </table> <p data-bbox="342 548 548 596">For pushbuttons (Used with 2V, 2YV)</p> <table data-bbox="370 604 623 737"> <tr> <td>Color</td> <td>Type</td> </tr> <tr> <td>Green</td> <td><b>AHX2615-G</b></td> </tr> <tr> <td>Red</td> <td><b>AHX2615-R</b></td> </tr> <tr> <td>Yellow</td> <td><b>AHX2615-Y</b></td> </tr> <tr> <td>Black</td> <td><b>AHX2615-B</b></td> </tr> </table>	Color	Type	Green	<b>AHX2616-G</b>	Red	<b>AHX2616-R</b>	White	<b>AHX2616-W</b>	Yellow	<b>AHX2616-Y</b>	Color	Type	Green	<b>AHX2615-G</b>	Red	<b>AHX2615-R</b>	Yellow	<b>AHX2615-Y</b>	Black	<b>AHX2615-B</b>
Color	Type																				
Green	<b>AHX2616-G</b>																				
Red	<b>AHX2616-R</b>																				
White	<b>AHX2616-W</b>																				
Yellow	<b>AHX2616-Y</b>																				
Color	Type																				
Green	<b>AHX2615-G</b>																				
Red	<b>AHX2615-R</b>																				
Yellow	<b>AHX2615-Y</b>																				
Black	<b>AHX2615-B</b>																				
<p data-bbox="120 785 277 810">Dust-tight cover</p>  <p data-bbox="112 995 175 1010">AF87-636</p>	<p data-bbox="342 785 651 863">For flush round (Used with 2F, 2FL, 2F5, 2FL5) Type: <b>AHX2603-2</b></p> <p data-bbox="342 898 711 976">For flush square (Used with 2SF, 2SFL, 2SF5, 2SFL5) Type: <b>AHX2603-2S</b></p> <p data-bbox="342 989 683 1014">These covers protect against dust.</p>																				
<p data-bbox="120 1043 237 1068">Key washer</p>  <p data-bbox="112 1232 175 1247">AF87-635</p>	<p data-bbox="370 1043 521 1068">Type: <b>AHX2601</b></p> <p data-bbox="423 1081 586 1106">Mounting hole, mm</p>  <p data-bbox="423 1232 483 1257"><math>\varnothing 16,2^{+0,2}</math></p>																				

# Pushbuttons/Selectors/Pilot Lights/buzzers AH164, AH165 and AH165-2 Accessories

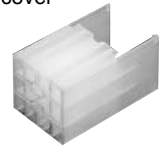
## ■ Accessories for AH164, AH165 and AH165-2

Description	Type		
<b>Incandescent lamp</b>   <small>SD-924</small>	Voltage	Type	
	6V, 0.6W	<b>AHX641</b>	
	14V, 0.7W	<b>AHX642</b>	
	28V, 0.7W	<b>AHX643</b>	
<b>LED lamp</b>   <small>AF02-116</small>	Voltage	Type	
	5V DC	<b>AHX695-5</b> □	
	6V DC	<b>AHX695-6</b> □	
	12V DC	<b>AHX695-12</b> □	
	24V DC	<b>AHX695-24</b> □	
	Replace the □ mark by the luminous color code Red (R), Green (G), Orange (O), Amber (A), Yellow (Y), Blue (S)		
<b>Neon lamp</b>   <small>SP-119</small>	Voltage	Type	Luminous color
	110V AC	<b>AHX655-H</b>	Green
		<b>AHX654-H</b>	Orange
	120V AC	<b>AHX655-K</b>	Green
		<b>AHX654-K</b>	Orange
	220V AC	<b>AHX655-M</b>	Green
		<b>AHX654-M</b>	Orange
	240V AC	<b>AHX655-P</b>	Green
		<b>AHX654-P</b>	Orange
<b>Panel plug</b>   <small>SI-186</small>	Color	Type	
Round	Black	<b>AHX622-B</b>	IP40
	Gray	<b>AHX622-GY</b>	IP40
	Black	<b>AHX644-B</b>	IP40
Square	Black	<b>AHX644-B</b>	IP40
	Gray	<b>AHX644-GY</b>	IP40
Rectangular	Black	<b>AHX645-B</b>	IP40
	Gray	<b>AHX645-GY</b>	IP40
	Black	<b>AHX850-B</b>	IP65
<b>Lamp changer</b>   <small>AF02-117</small>	Type: <b>AHX672</b>		
	If the switch is fitted with a lamp, use this tool to remove the lamp. The tool is unnecessary when installing a lamp.		
<b>Remover</b>   <small>SE-34</small>	Type: <b>AHX618</b>		
	This tool is used for replacing the color chips or screens.		
<b>Contact holder remover</b>   <small>SP-522</small>	Type: <b>AHX699</b>		
	This tool is used to remove a contact holder when switches are densely installed.		

Description	Type
<b>Wrench</b>   <small>SE-741</small>	Type: <b>AHX601</b>
	When installing a command switch on a panel, this tool is useful for tightening the switch firmly and efficiently.
<b>Terminal cover</b>   <small>AF87-637</small>	Type: <b>AHX2602</b>
	This cover is used with AH164 and AH165 and AH165-2 (except pilot lights). Pass the wires through the cover, then mount the cover in position.
<b>Contact block</b>   <small>SK-1140</small>	Terminal Type
	Solder/Tab <b>AGX001</b>
	Wire-wrap <b>AGX001-W</b>
<b>Dummy unit</b>   <small>SK-1141</small>	Type: <b>AGX002</b>
	A dummy unit is used to fill the space where no contact blocks are installed. For example, two dummy units are used if 1NO+1NC contact block is installed, and one dummy unit is used if 2NO+2NC contact blocks are installed.
<b>Remover</b>   <small>SM-334</small>	Type: <b>AGX012</b>
	This tool is used for replacing the contact blocks or dummy units.

# Pushbuttons/Selectors/Pilot Lights/Buzzers

## AH164, AH165 and AH165-2

### Accessories

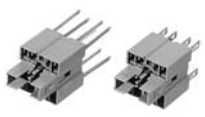
Description	Type		
<b>Sockets</b>  	Terminal	Type	Used with
	Solder/Tab Wire-wrap PC board	<b>AHX697-S</b> <b>AHX697-W</b> <b>AHX697-P</b>	Pushbuttons
<b>Sockets for LED</b>  	Terminal	Type	
	Solder/Tab Wire-wrap	<b>AHX697-SH3</b> <b>AHX697-WH3</b>	Illuminated pushbuttons
SM-1097	Contact arrangement is 2NO+2NC only. Except for AH165-2PL types		
SM-1098	<ul style="list-style-type: none"> <li>• Contact arrangement is 2NO+2NC only.</li> <li>• These sockets are used only when LED lamps rated for 24V DC are used under 110V AC/DC.</li> <li>• Except for AH164, 165 and 165-2 series pilot lights or AH165-2PL type.</li> <li>• When side-by-side mounting and continuous lighting, note that a socket has higher temperature over the ambient temperature.</li> </ul>		

#### Dimensions, mm

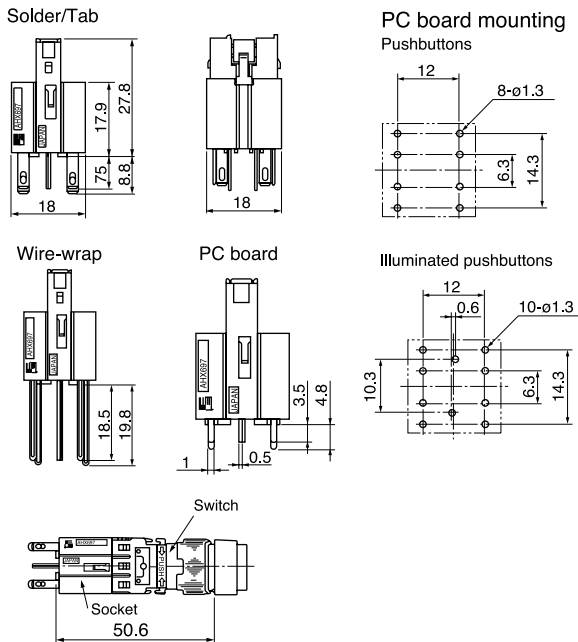

For wiring to wire-wrap pin terminals, select appropriate wire sizes and tool from the table below.

Wire size	Bit	Sleeve	Number of effective wraps
0.4mm dia.	3-A	1-B	About 8
0.5mm dia.	1-A	1-B	About 6
(0.65mm dia.)	(2-A)	(2-B)	(About 6)

Use ordinary wrapping for connection. Wires of 0.65mm dia. must not be used on adjacent terminals. However, 0.65mm dia. wire can be mixed with 0.4mm and 0.5mm dia. wires.



# Pushbuttons/Selectors/Pilot Lights/Buzzers

## AH164, AH165 and AH165-2

### Mass

#### ■ Mass, gram

#### AH164 series

Type	1NO	2NO	3NO
	+	+	+
	1NC	2NC	3NC
AH164-L,L5 (Without transformer)	12.5	13.5	14.5
L,L5 (With transformer)	53.5	54.5	-
SL,SL5 (Without transformer)	13.1	14.1	15.1
SL,SL5 (With transformer)	54.1	55.1	-
TL,TL5 (Without transformer)	13.9	14.9	15.9
TL,TL5 (With transformer)	54.9	55.9	-
TGL,TGL5 (Without transformer)	13.9	14.9	15.9
TGL,TGL5 (With transformer)	54.9	55.9	-
SGL,SGL5 (Without transformer)	13.1	14.1	15.1
SGL,SGL5 (With transformer)	54.1	55.1	-
AH164-E,E5	10.5	11.5	12.5
M,M5	12.5	13.5	14.5
SF,SF5	11.1	12.1	13.1
TF,TF5	11.9	12.9	13.9
TGF,TGF5	11.9	12.9	13.9
SGF,SGF5	11.1	12.1	13.1
SM,SM5	13.4	14.4	15.4
TM,TM5	13.1	14.1	15.1
AH164-P2,P0	16.4	17.4	18.4
P3,P6,P7,P1	-	17.4	18.4
PK3,PK6,PK7,PK1	-	17.4	18.4
SP2,SP0	15.8	16.8	17.8
SP3,SP6,SP7,SP1	-	16.8	17.8
SPK3,SPK6,SPK7,SPK1	-	16.8	17.8
J2,J0	30.4	31.4	32.4
J3,J6,J7,J1	-	31.6	32.6
JK3,JK6,JK7,JK1	-	31.6	32.6
SJ2,SJ0	29.8	30.8	31.8
SJ3,SJ6,SJ7,SJ1	-	30.8	31.8
SJK3,SJK6,SJK7,SJK1	-	30.8	31.8
AH164-Z (Without transformer)	6.9		
Z (With transformer)	50.9		
ZS (Without transformer)	7.5		
ZS (With transformer)	51.5		
ZT (Without transformer)	8.2		
ZT (With transformer)	52.2		
AH164-TX	16		
TX1	17.5		
TX2B	13.2		
AH164-TS	9.7		
TC	15.6		
TC4□E-□K1	46.4		
TC4□E-□K	52.8		

#### AH165 series

Type	1NO	2NO	3NO
	+	+	+
	1NC	2NC	3NC
AH165-L,L5 (Without transformer)	12.5	13.5	14.5
L,L5 (With transformer)	53.5	54.5	-
SL,SL5 (Without transformer)	13.1	14.1	15.1
SL,SL5 (With transformer)	54.1	55.1	-
TL,TL5 (Without transformer)	13.9	14.9	15.9
TL,TL5 (With transformer)	54.9	55.9	-
TGL,TGL5 (Without transformer)	13.9	14.9	15.9
TGL,TGL5 (With transformer)	54.9	55.9	-
SGL,SGL5 (Without transformer)	13.1	14.1	15.1
SGL,SGL5 (With transformer)	54.1	55.1	-
AH165-E,E5	10.5	11.5	12.5
M,M5	12.5	13.5	14.5
SF,SF5	11.1	12.1	13.1
TF,TF5	11.9	12.9	13.9
TGF,TGF5	11.9	12.9	13.9
SGF,SGF5	11.1	12.1	13.1
SM,SM5	13.4	14.4	15.4
TM,TM5	13.1	14.1	15.1
VR	13.4 * <sup>1</sup>	14 * <sup>2</sup>	-
V1R	14.3 * <sup>1</sup>	14.9 * <sup>2</sup>	-
AH165-V5R	18 * <sup>1</sup>	18.6 * <sup>2</sup>	-
V6R	18.9 * <sup>1</sup>	19.5 * <sup>2</sup>	-
AH165-P2,P0	16.7	17.7	18.7
P3,P6,P7,P1	-	17.7	18.7
PK3,PK6,PK7,PK1	-	18	19
SP2,SP0	16.1	17.1	18.1
SP3,SP6,SP7,SP1	-	17.1	18.1
SPK3,SPK6,SPK7,SPK1	-	17.1	18.1
J2,J0	31.1	32.1	33.1
J3,J6,J7,J1	-	32.1	33.1
JK3,JK6,JK7,JK1	-	32.1	33.1
SJ2,SJ0	30.5	31.5	32.5
SJ3,SJ6,SJ7,SJ1	-	31.5	32.5
SJK3,SJK6,SJK7,SJK1	-	31.5	32.5
AH165-JM2	30	34.4	-
RJM2	29.6	34	-
AH165-Z (Without transformer)	6.9		
Z (With transformer)	50.9		
ZS (Without transformer)	7.5		
ZS (With transformer)	51.5		
ZT (Without transformer)	8.2		
ZT (With transformer)	52.2		
ZM (Without transformer)	5.4		
AH165-X	13.6		
AH165-TS	9.7		
TC	15.6		
TC4□E-□K1	46.4		
TC4□E-□K	52.8		

Note: \*<sup>1</sup> For 1NC

\*<sup>2</sup> For 2NC

**Pushbuttons/Selectors/Pilot Lights/Buzzers**  
**AH164, AH165 and AH165-2**  
**Mass**

■ **Mass, gram**

**AH165-2 series**

Type	1NO + 1NC	2NO + 2NC	3NO + 3NC
AH165-2FL,FL5	15.2	16.2	17.2
2EL,EL5	15.6	16.6	17.6
2ML	18.7	19.7	20.7
2YML	20.2	21.2	22.2
2SFL,SFL5	16.5	17.5	18.5
2SEL,SEL5	17.4	18.4	19.4
2SCL,SCL5	17.6	18.6	19.6
2VL	19.9	20.9	21.9
2YVL	21.4	22.4	23.4
AH165-2F,F5	14.4	15.4	16.4
2E,E5	14.8	15.8	16.8
2M	16.7	17.7	18.7
2YM	18.2	19.2	20.2
2SF,SF5	14.5	15.5	16.5
2SE,SE5	15.4	16.4	17.4
2SCE,SCE5	15.6	16.6	17.6
2S2	-	19	-
2YS2	-	20.6	-
2V	17.9	18.9	19.9
2YV	19.4	20.4	21.4
AH165-2P2,P0	17.1	18.1	19.1
2P3,P6,P7,P1	-	18.1	19.1
2YP2,YP0	18.7	19.7	20.7
2YP3,YP6,YP7,YP1	-	19.7	20.7
2J2,J0	40	41	42
2J3,J6,J7,J1	-	41	42
2YJ2	41.6	42.6	43.6
2YJ3,YJ6,YJ7,YJ1	-	42.6	43.6
2H	14.3	15.3	16.3
2SH	16.1	17.1	18.1
AH165-2PL2	17.3	18.3	-
2PL3	-	18.3	-
AH165-2Z	9.7		
2ZE	10.1		
2SZ	10.9		
2SZE	11.4		

## AH-series Pushbutton cross to AR-series Pushbutton

Discontinued	Replacement	Discontinued	Replacement		
PART #	PART #	PART #	PART #	TYPE	
AH22-AA@.....@	AR22A5N-@@@@B	AH30-SAA@.....@	AR30A5N-@@@@B	Joy stick selector switch	
-	AR22A5H-@@@@B	AH30-SAA@.....@-S	AR30A5H-@@@@B		
AH22-ALA@.....@	AR22A6N-@@@@B	AH30-SALA@.....@	AR30A6N-@@@@B		
-	AR22A6H-@@@@B	AH30-SALA@.....@-S	AR30A6H-@@@@B		
AH22-ALM@.....@	AR22A1N-@@@@B	AH30-SALM@.....@	AR30A1N-@@@@B		
AH22-AM@.....@	AR22A0N-@@@@B	AH30-SAM@.....@	AR30A0N-@@@@B		
-	AR22A0H-@@@@B	AH30-SAM@.....@-S	AR30A0H-@@@@B		
-	AR22A1H-@@@@B	AH30-SALM@.....@-S	AR30A1H-@@@@B		
-	AR22A2N-@@@@B	-	AR30A2N-@@@@B		
-	AR22A2H-@@@@B	-	AR30A2H-@@@@B		
-	AR22A7N-@@@@B	-	AR30A7N-@@@@B		
-	AR22A7H-@@@@B	-	AR30A7H-@@@@B		
-	-	AH30-B1#@@	AR30B0R-@@#		Giant head
-	-	AH30-B2#@@	AR30B1R-@@#		
-	-	AH30-B3#@@	AR30B2R-@@#		
-	-	AH30-B4#@@	AR30B3R-@@#		
-	-	AH30-C@@%	-	Coin	
-	-	AH30-D@@%	-	Key	
AH22/25-E#@@	AR22E0R-@@#	AH30-E#@@	AR30E0R-@@#	Round extended head	
AH22/25-E5#@@	AR22E5R-@@#	AH30-E5#@@	AR30E5R-@@#		
AH22-EL#@*%&	AR22E0L-@@*%&	-	-		
AH22-EL5#@*%&	AR22E5L-@@*%&	-	-		
-	-	AH30F#@@/ES	AR30FVR-@@#	E-stop	
AH22/25-F#@@	AR22F0R-@@#	AH30-F#@@	AR30F0R-@@#	Flush head	
AH22/25-F5#@@	AR22F5R-@@#	AH30-F5#@@	AR30F5R-@@#		
AH25-G#@@	AR22G0R-@@#	AH30-G#@@	AR30G0R-@@#	w/guard	
AH22/25-G1#@@	AR22G3R-@@#	AH30-G1#@@	AR30G1R-@@#	Pin-lock	
-	-	AH30-G3#@@	AR30GPR-@@#		
AH25-G5#@@	-	AH30-G5#@@	-	w/guard	
AH22/25-G6#@@	AR22G8R-@@#	AH30-G6#@@	AR30G6R-@@#	w/guard	
AH22-GL1#@*%&	AR22G4L-@@*%&	-	-		
AH22-GL6#@*%&	AR22G9L-@@*%&	-	-		
-	-	AH30-H2@@	AR30WR-2@@#	Selector switch	
-	-	AH30-H3@@	AR30WR-3@@#		
AH22/25-J0A@@%	AR22JR-0A@@%	AH30-J0A@@%	AR30JR-0A@@%	Key selector switch	
AH22/25-J1E@@%	AR22JR-1E@@%	AH30-J1E@@%	AR30JR-1E@@%		
AH22/25-J2\$@@%	AR22JR-2\$@@%	AH30-J2\$@@%	AR30JR-2\$@@%		
AH22/25-J3\$@@%	AR22JR-3\$@@%	AH30-J3\$@@%	AR30JR-3\$@@%		
AH22/25-J6\$@@%	AR22JR-6\$@@%	AH30-J6\$@@%	AR30JR-6\$@@%		
AH22/25-J7\$@@%	AR22JR-7\$@@%	AH30-J7\$@@%	AR30JR-7\$@@%		
AH22-JC1E@@@%	AR22JCR-1\$@@@%	AH30-JC\$@@@%	AR30JCR-3\$@@@%		
AH22-JC3\$@@@%	AR22JCR-3\$@@@%	-	-		
AH22-JC6\$@@@%	AR22JCR-6\$@@@%	-	-		
AH22-JC7\$@@@%	AR22JCR-7\$@@@%	-	-		
-	-	AH30-K2\$@@	-		
-	-	AH30-K3\$@@	-		

@: contacts arrangement      &: lamp type  
#: color of button or groove      \$: draw-out position of key  
\*: lamp voltage      %: type of key

# AH-series Pushbutton cross to AR-series Pushbutton

Discontinued		Replacement		Discontinued		Replacement	
PART #	PART #	PART #	PART #	PART #	PART #	PART #	TYPE
AH25-L#@*&	AR22E0L-@*&#	AH30-L#@*&	AR30E0L-@*&#				Extended w/guard
AH25-L2#@*&	AR22G4L-@*&#	AH30-L2#@*&	AR30G4L-@*&#				
AH25-L3#@*&	AR22G4L-@*&#	AH30-L3#@*&	AR30G3L-@*&#				
AH25-L4#@*&	AR22G4L-@*&#	AH30-L4#@*&	AR30G4L-@*&#				
AH25-L5#@*&	AR22E5L-@*&#	AH30-L5#@*&	AR30E5L-@*&#				Extended w/guard
AH25-L6#@*&	AR22G9L-@*&#	AH30-L6#@*&	AR30G9L-@*&#				
AH25-L7#@*&	AR22G9L-@*&#	AH30-L7#@*&	AR30G8L-@*&#				Mushroom head
AH22-M#@@	AR22M0R-@#@	AH30-M#@@	AR30M0R-@#@				
AH25-M#@@	AR22M4R-@#@	-	-				
-	-	AH30-M2#@@					
AH22-M2#@@	AR22M3R-@#@	AH30-M1#@@	AR30M3R-@#@				
AH22-M5#@@	AR22M5R-@#@	AH30-M5#@@	AR30M5R-@#@				
AH25-M5#@@	AR22M5R-@#@	-	-				
-	-	AH30-M6#@@	-				
AH22-M7#@@	-	AH30-M7#@@	-				
AH22-ML#@*&	AR22M0L-@*&#	-	-				
AH22-ML5#@*&	AR22M5L-@*&#	-	-				
AH22-MS#@@	AR22M4R-@#@	AH30-MS#@@	AR30M4R-@#@				
AH22-MS5#@@	-	AH30-MS5#@@	-				
AH22-MSL#@*&	AR22M4L-@*&#	-	-				
AH22-MSL5#@*&	-	-	-				
-	-	AH30-NR@@	AR30N0R-@@R				
AH22/25-P0#@@	AR22PR-0@#@	AH30-P0#@@	AR30PR-0@#@				Selector switch
AH22/25-P1#@@	AR22PR-1@#@	AH30-P1#@@	AR30PR-1@#@				
AH22/25-P2#@@	AR22PR-2@#@	AH30-P2#@@	AR30PR-2@#@				
AH22/25-P3#@@	AR22PR-3@#@	AH30-P3#@@	AR30PR-3@#@				
AH25-P5#@@	AR22PR-6@#@	-	-				
AH22-P6#@@	AR22PR-6@#@	AH30-P5#@@	AR30PR-6@#@				
AH22-P7#@@	AR22PR-7@#@	AH30-P6#@@	AR30PR-7@#@				
AH25-PC#@@@	AR22PCR-3@#@#@	AH30-PC#@@	AR30PCR-3@#@#@				
AH22-PC1#@@@	AR22PCR-1@#@#@	-	-				
AH22-PC3#@@@	AR22PCR-3@#@#@	-	-				
AH22-PC4#@@@	AR22PCR-4@#@#@	-	-				
AH22-PC5#@@@	AR22PCR-5@#@#@	-	-				
AH22-PC6#@@@	AR22PCR-6@#@#@	-	-				
AH22-PC7#@@@	AR22PCR-7@#@#@	-	-				
AH22-PCL3#@@*&	-	-	-				
AH22-PCL4#@@*&	-	-	-				
AH22-PCL5#@@*&	-	-	-				
AH22/25-PL0#@@*&	AR22PL-0@@*&#	AH30-PL0#@@*&	AR30PL-0@@*&#				
AH22-PL1#@@*&	-	AH30-PL1#@@*&	-				
AH22/25-PL2#@@*&	AR22PL-2@@*&#	AH30-PL2#@@*&	AR30PL-2@@*&#				
AH22-PL3#@@*&	AR22PL-3@@*&#	AH30-PL3#@@*&	AR30PL-3@@*&#				
AH22-PL6#@@*&	AR22PL-6@@*&#	AH30-PL6#@@*&	AR30PL-6@@*&#				
AH22-PL7#@@*&	AR22PL-7@@*&#	AH30-PL7#@@*&	AR30PL-7@@*&#				

@: contacts arrangement  
#: color of button or groove  
\*: lamp voltage

&: lamp type  
\$: draw-out position of key  
%: type of key

## AH-series Pushbutton cross to AR-series Pushbutton

Discontinued		Replacement		
PART #	PART #	PART #	PART #	TYPE
AH22-PR0#@@	AR22RR-0@@#	-	-	Selector switch
AH22-PR1#@@	AR22RR-1@@#	-	-	
AH22-PR2#@@	AR22RR-2@@#	-	-	
AH22-PR3#@@	AR22RR-3@@#	-	-	
AH22-PR6#@@	AR22RR-6@@#	-	-	
AH22-PR7#@@	AR22RR-7@@#	-	-	
AH22-PRC1#@@@	AR22RCR-1@@@#	-	-	
AH22-PRC3#@@@	AR22RCR-3@@@#	-	-	
AH22-PRC4#@@@	AR22RCR-4@@@#	-	-	
AH22-PRC5#@@@	AR22RCR-5@@@#	-	-	
AH22-PRC6#@@@	AR22RCR-6@@@#	-	-	
AH22-PRC7#@@@	AR22RCR-7@@@#	-	-	
AH22/25-PW0#@@	AR22WR-0@@#	AH30-PW0#@@	AR30WR-0@@#	
AH22/25-PW1#@@	AR22WR-1@@#	AH30-PW1#@@	AR30WR-1@@#	
AH22/25-PW2#@@	AR22WR-2@@#	AH30-PW2#@@	AR30WR-2@@#	
AH22/25-PW3#@@	AR22WR-3@@#	AH30-PW3#@@	AR30WR-3@@#	
AH25-PW5#@@	AR22WR-6@@#	-	-	
AH22-PW6#@@	AR22WR-6@@#	AH30-PW5#@@	AR30WR-6@@#	
AH22-PW7#@@	AR22WR-7@@#	-	AR30WR-7@@#	
AH22-PWC1#@@@	AR22WCR-1@@@#	-	-	
AH22-PWC3#@@@	AR22WCR-3@@@#	-	-	
AH22-PWC4#@@@	AR22WCR-4@@@#	-	-	
AH22-PWC5#@@@	AR22WCR-5@@@#	-	-	
AH22-PWC6#@@@	AR22WCR-6@@@#	-	-	
AH22-PWC7#@@@	AR22WCR-7@@@#	-	-	
-	-	AH30-Q#11	-	Push-pull
AH22-Q2#@@	AR22Q2R-@@#	AH30-Q2#@@	AR30Q2R-@@#	Numerical indicator
AH22-S1C4#*(-N)	DR22N1-(N)*#	AH30-S1C4#*(-N)	DR30N1-(N)*#	
AH22-S2C4#*(-N)	DR22N2-(N)*#	AH30-S2C4#*(-N)	DR30N2-(N)*#	w/selector ring
AH22/25-S1#@@	AR22S1R-22#	AH30-S1#@@	AR30S1R-22#	
AH22/25-S2#@@	AR22S2R-@@#	AH30-S2#@@	AR30S2R-@@#	
AH22/25-S3#@@	AR22S3R-@@#	AH30-S3#@@	AR30S3R-@@#	
AH22/25-S4#@@	-	AH30-S4#@@	-	
AH22/25-S5#@@	-	AH30-S5#@@	-	
AH22/25-S6#@@	AR22S6R-@@#	AH30-S6#@@	AR30S6R-@@#	
AH22/25-SE#@@	AR22E0S-@@#	AH30-SE#@@	(AR22 series+AR9Y003)	Extended head
AH22/25-SE5#@@	AR22E5S-@@#	AH30-SE5#@@	(AR22 series+AR9Y003)	
AH22-SEL#@@*&	AR22E0M-@@*&#	-	-	Flush head
AH22-SEL5#@@*&	AR22E5M-@@*&#	-	-	
AH22/25-SF#@@	AR22F0S-@@#	AH30-SF#@@	(AR22 series+AR9Y003)	
AH22/25-SF5#@@	AR22F5S-@@#	AH30-SF5#@@	(AR22 series+AR9Y003)	
AH22-SFL#@@*&	AR22F0M-@@*&#	-	-	
AH22-SFL5#@@*&	AR22F5M-@@*&#	-	-	
AH25-SJ2#@@	AR22JY-2\$@@%	AH30-SJ2#@@	(AR22 series+AR9Y003)	Selector switch
AH25-SJ3#@@	AR22JY-3\$@@%	AH30-SJ3#@@	(AR22 series+AR9Y003)	
AH25-SL#@@*&	AR22E0M-@@*&#	AH30-SL#@@*&	(AR22 series+AR9Y003)	Extended
AH25-SL1#@@*&	AR22F0M-@@*&#	AH30-SL1#@@*&	(AR22 series+AR9Y003)	Flush
AH25-SL5#@@*&	AR22E5M-@@*&#	AH30-SL5#@@*&	(AR22 series+AR9Y003)	Extended
AH25-SL6#@@*&	AR22F5M-@@*&#	AH30-SL6#@@*&	(AR22 series+AR9Y003)	Flush
AH25-SP2#@@	AR22PY-2@@#	AH30-SP2#@@	(AR22 series+AR9Y003)	Selector switch
AH25-SP3#@@	AR22PY-3@@#	AH30-SP3#@@	(AR22 series+AR9Y003)	

@: contacts arrangement  
#: color of button or groove  
\*: lamp voltage

&: lamp type  
\$: draw-out position of key  
%: type of key

# AH-series Pushbutton cross to AR-series Pushbutton

Discontinued		Replacement		Discontinued		Replacement		
PART #		PART #		PART #		PART #		TYPE
AH22-SZ#*&	DR22F3M-*&#	AH30-SZ#*&						Pilot light
AH22-TZ#*&	DR22E3N-*&#	-		-				
-	-	AH30-T#11*&	AR30Q7L-11*&#					Push-pull
AH22-UH@@	-	-		-				Wobble
AH25-UB@@	-	AH30-UB@@	-					stick
-	-	AH30-V1R@@	AR30V1R-@@R					E-stop
-	-	AH30-V5R@@	-					
-	-	AH30-V6R@@	-					
-	-	AH30-VEL1R@@	-					
-	-	AH30-VELR@@*&	AR30V2L-@@*&R					
-	-	AH30-VER@@	AR30V2R-@@R					
AH22-VJR@@	AR22V7R-@@R	-	-					
AH22-VL1R@@*&	AR22VAL-@@*&R	-	-					
AH22/25-VLR@@*&	AR22V2L-@@*&R	AH30VLR@@*&	AR30V2L-@@*&R					
AH22-VNLR@@*&	AR22VKL-@@*&R	-	-					
AH22-VNR@@	AR22VKR-@@R	-	-					
AH22/25-VR@@	AR22V2R-@@R	AH30-VR@@*	AR30V2R-@@R					
AH22-VSJR@@	AR22V7R-@@R	-	-					
AH22-VSLR@@*&	AR22V2L-@@*&R	-	-					
AH22-VSR@@	AR22V4R-@@R	-	-					
-	-	AH30-W1#@@	-					Lever
-	-	AH30-W3#@@	-					select
-	-	AH30-X1B*	DR30B6-*B					Buzzer
AH22-X2B*	DR22B3-*B	AH30-X2B*	DR30B0-*B					
AH22-XB*	DR22B5-*B	AH30-XB*	DR30B5-*B					
AH22-YE#@@	AR22E0Y-@@#	-	-					Extended
AH22-YE5#@@	AR22E5Y-@@#	-	-					head
AH22-YEL#@@*&	AR22E0P-@@*&#	-	-					
AH22-YEL5#@@*&	AR22E5P-@@*&#	-	-					
AH22-YF#@@	AR22F0Y-@@#	-	-					Flush
AH22-YF5#@@	AR22F5Y-@@#	-	-					head
AH22-YJ0A@@%	AR22JY-0A@@%	-	-					Selector
AH22-YJ1E@@%	AR22JY-1E@@%	-	-					switch
AH22-YJ2\$@@%	AR22JY-2\$@@%	-	-					
AH22-YJ3\$@@%	AR22JY-3\$@@%	-	-					
AH22-YJ6\$@@%	AR22JY-6\$@@%	-	-					
AH22-YJ7\$@@%	AR22JY-7\$@@%	-	-					
AH22-YJC1E@@@%	AR22JCY-1\$@@@%	-	-					
AH22-YJC3\$@@@%	AR22JCY-3\$@@@%	-	-					
AH22-YJC6\$@@@%	AR22JCY-6\$@@@%	-	-					
AH22-YJC7\$@@@%	AR22JCY-7\$@@@%	-	-					
AH22-YMS#@@	AR22M4Y-@@#	-	-					Mushroom
AH22-YMS5#@@	-	-	-					head

@: contacts arrangement      &: lamp type  
#: color of button or groove      \$: draw-out position of key  
\*: lamp voltage      %: type of key

## AH-series Pushbutton cross to AR-series Pushbutton

Discontinued		Replacement		Discontinued		Replacement	
PART #	PART #	PART #	PART #	PART #	PART #	TYPE	
AH22-YP0#@@	AR22PY-0@@#	-	-	-	-	Selector switch	
AH22-YP1#@@	AR22PY-1@@#	-	-	-	-		
AH22-YP2#@@	AR22PY-2@@#	-	-	-	-		
AH22-YP3#@@	AR22PY-3@@#	-	-	-	-		
AH22-YP6#@@	AR22PY-6@@#	-	-	-	-		
AH22-YP7#@@	AR22PY-7@@#	-	-	-	-		
AH22-YPC1#@@@	AR22PCY-1@@@#	-	-	-	-		
AH22-YPC3#@@@	AR22PCY-3@@@#	-	-	-	-		
AH22-YPC6#@@@	AR22PCY-6@@@#	-	-	-	-		
AH22-YPC7#@@@	AR22PCY-7@@@#	-	-	-	-		
AH22-YPL0#@*#&	AR22PP-0@@*#&	-	-	-	-		
AH22-YPL1#@*#&	AR22PP-1@@*#&	-	-	-	-		
AH22-YPL2#@*#&	AR22PP-2@@*#&	-	-	-	-		
AH22-YPL3#@*#&	AR22PP-3@@*#&	-	-	-	-		
AH22-YPL6#@*#&	AR22PP-6@@*#&	-	-	-	-		
AH22-YPL7#@*#&	AR22PP-7@@*#&	-	-	-	-		
AH22-YPR0#@@	AR22RY-0@@#	-	-	-	-		
AH22-YPR1#@@	AR22RY-1@@#	-	-	-	-		
AH22-YPR2#@@	AR22RY-2@@#	-	-	-	-		
AH22-YPR3#@@	AR22RY-3@@#	-	-	-	-		
AH22-YPR6#@@	AR22RY-6@@#	-	-	-	-		
AH22-YPR7#@@	AR22RY-7@@#	-	-	-	-		
AH22-YPRC1#@@@	AR22RCY-1@@@#	-	-	-	-		
AH22-YPRC3#@@@	AR22RCY-3@@@#	-	-	-	-		
AH22-YPRC6#@@@	AR22RCY-6@@@#	-	-	-	-		
AH22-YPRC7#@@@	AR22RCY-7@@@#	-	-	-	-		
AH22-YPW0#@@	AR22WY-0@@#	-	-	-	-		
AH22-YPW1#@@	AR22WY-1@@#	-	-	-	-		
AH22-YPW2#@@	AR22WY-2@@#	-	-	-	-		
AH22-YPW3#@@	AR22WY-3@@#	-	-	-	-		
AH22-YPW6#@@	AR22WY-6@@#	-	-	-	-		
AH22-YPW7#@@	AR22WY-7@@#	-	-	-	-		
AH22-YPWC1#@@@	AR22WCY-1@@@#	-	-	-	-		
AH22-YPWC3#@@@	AR22WCY-3@@@#	-	-	-	-		
AH22-YPWC6#@@@	AR22WCY-6@@@#	-	-	-	-		
AH22-YPWC7#@@@	AR22WCY-7@@@#	-	-	-	-		
AH22-YS1 to 6#*#&	-	-	-	-	-	w/selector ring	
AH22-YZ#*#&	DR22E3P-*#&	-	-	-	-	Pilot light	
AH22-Z#*#&	DR22E3L-*#&	-	-	-	-		
AH22/25-ZM#*#&	DR22D0L-*#&	AH30-ZM#*#&	DR30D0L-*#&	-	-		
AH25-ZN#*#&	-	AH30-ZN#*#&	DR30F4M-*#&	-	-		
-	DR22F4M-*#&	-	-	-	-		
-	-	AH30-ZN1#*#&	DR30F4N-*#&	-	-		
-	-	AH30-ZN2#*#&	DR30F4N-*#&	-	-		
-	-	AH30-ZN4#*#&	DR30M4M-*#&	-	-		
AH25-ZK#*#&	DR22K0L-*#&	AH30-ZK#*#&	DR30K0L-*#&	-	-		
AH25-ZS#*#&	DR22E3M-*#&	-	-	-	-		
-	-	AH30-ZS#*#&	DR30F4M-*#&	-	-		
-	-	AH30-ZV#*#&	DR30D1L-*#&	-	-		

@: contacts arrangement  
#: color of button or groove  
\*: lamp voltage

&: lamp type  
\$: draw-out position of key  
%: type of key

# AH-series Pushbutton cross to AR-series Pushbutton

Discontinued	Replacement		Discontinued	Replacement
	AH22	AH25 (*1)		
AH22-%#012	AH25-PC#012	AR22&-3014#	AH30-#\$012	AR30&-3014#
AH22-%#022	AH25-PC#022	AR22&-3024#	AH30-#\$022	AR30&-3024#
AH22-%#032	AH25-PC#032	AR22&-303C#	AH30-#\$032	AR30&-303C#
AH22-%#033 (*1)	-	AR22&-303C#	-	-
AH22-%#042	AH25-PC#042	AR22&-3044#	AH30-#\$042	AR30&-3044#
AH22-%#052	AH25-PC#052	AR22&-3054#	AH30-#\$052	AR30&-3054#
AH22-%#062	AH25-PC#062	AR22&-3064#	AH30-#\$062	AR30&-3064#
AH22-%#071	-	AR22&-307F#	-	-
AH22-%#072	AH25-PC#072	AR22&-307C#	AH30-#\$072	AR30&-307C#
AH22-%#073 (*1)	-	AR22&-307C#	-	-
AH22-%#082	AH25-PC#082	AR22&-3084#	AH30-#\$082	AR30&-3084#
AH22-%#092	AH25-PC#092	AR22&-3094#	AH30-#\$092	AR30&-3094#
AH22-%#102	AH25-PC#102	AR22&-3104#	AH30-#\$102	AR30&-3104#
AH22-%#112	AH25-PC#112	AR22&-311C#	AH30-#\$112	AR30&-311C#
AH22-%#114 (*1)	-	AR22&-311C#	-	-
AH22-%#122	AH25-PC#122	AR22&-3124#	AH30-#\$122	AR30&-3124#
AH22-%#132	AH25-PC#132	AR22&-3134#	AH30-#\$132	AR30&-3134#
-	AH25-PC#142	AR22&-314D#	AH30-#\$142	AR30&-314D#
AH22-%#143	-	AR22&-314D#	-	-
-	AH25-PC#152	AR22&-315A#	AH30-#\$152	AR30&-315A#
AH22-%#153	-	AR22&-315A#	-	-
AH22-%#162	AH25-PC#162	AR22&-3164#	AH30-#\$162	AR30&-3164#
AH22-%#172	AH25-PC#172	AR22&-3174#	AH30-#\$172	AR30&-3174#
AH22-%#182	AH25-PC#182	AR22&-3184#	AH30-#\$182	AR30&-3184#
AH22-%#192	AH25-PC#192	AR22&-3194#	AH30-#\$192	AR30&-3194#
-	AH25-PC#202	AR22&-320B#	AH30-#\$202	AR30&-320B#
AH22-%#204	-	AR22&-320B#	-	-
-	AH25-PC#212	AR22&-3094#	AH30-#\$212	AR30&-3094#
AH22-%#412	-	AR22&-441C#	-	-
AH22-%#512	-	AR22&-551C#	-	-

%; JC, PC, PRC, PWC, YPC, YPRC, YPW, YJC, PCL

\$: PC, JC

&: JCR, PCR, RCR, WCR, JCY, PCY, RCY, WCY

Note \*1: Terminal wirings for AR series are different from AH series

Knob	Bezel	AH22	AH25 (*1)	AR22	AH30 (*1)	AR30
Standard	Round	PC	PC	PCR	PC	PCR
	Square	YPC	-	PCY	-	-
Long	Round	PWC	-	WCR	-	-
	Square	YPWC	-	WCY	-	-
Round	Round	PRC	-	RCR	-	-
	Square	YPRC	-	RCY	-	-
Key	Round	JC	-	JCR	JC	JCR
	Square	YJC	-	JCY	-	-
Illuminated Standard	Round	PCL	-	-	-	-



## AH-series Pushbutton cross to AR-series Pushbutton

Discontinued	Replacement	
PART #	PART #	TYPE
RCa470-AE#@	AR30E5R-@@#	Round extended head
RCa470-AF@	AR30F5R-@@#	Flush head
RCa470-AG#@	-	w/guard
RCa470-AG1#@	AR30G6R-@@#	w/guard
RCa470-B1#@	AR30B0R-@@#	Giant head
RCa470-B2#@	AR30B1R-@@#	
RCa470-B3#@	AR30B2R-@@#	
RCa470-B4#@	AR30B3R-@@#	
RCa470-D@%	-	Push button w/key
RCa470-EF#@	AR30E0R-@@#	Round extended head
RCa470-F#@	AR30F0R-@@#	Flush head
RCa470-G#@	AR30G0R-@@#	w/guard
RCa470-G1#@	AR30G1R-@@#	
RCa470-H2#@	AR30WR-2@@#	Selector switch
RCa470-H3#@	AR30WR-3@@#	
RCa470-HA01#@	AR30WR-1@@#	
RCa470-J2\$@%	AR30JR-2\$@@%	Key selector switch
RCa470-J3\$@%	AR30JR-3\$@@%	
RCa470-JA01\$@%	AR30JR-1E@@%	
RCa470-JA2\$@%	AR30JR-0A@@%	
RCa470-JA3\$@%	AR30JR-6\$@@%	
RCa470-JC3\$@@@%	AR30JCR-3\$@@@%	
RCa470-K2\$@%	-	
RCa470-K3\$@%	-	
RCa470-L#@(T)*	AR30E0L-@@*&#	Round extended head
RCa470-L#@(T)*G	AR30G4L-@@*&#	w/guard
RCa470-L#@*GS	AR30G3L-@@*&#	
RCa470-L3#@(T)*	-	Round extended head
RCa470-L4#1(T)*	-	
RCa470-M#@	AR30M0R-@@#	Mushroom head
RCa470-M1#@	-	
RCa470-M2#@	AR30M3R-@@#	
RCa470-N#@	AR30N0R-@@R	Turn-lock

@: contacts arrangement  
#: color of button or groove  
\*: lamp voltage

&: lamp type  
\$: draw-out position of key  
%: type of key

Discontinued	Replacement	
PART #	PART #	TYPE
RCa470-P2#@	AR30PR-2@@#	Selector switch
RCa470-P3#@	AR30PR-3@@#	
RCa470-PA01#@	AR30PR-1@@#	
RCa470-PA2#@	AR30PR-0@@#	
RCa470-PA3#@	AR30PR-6@@#	
RCa470-PC#@@@	AR30PCR-3@@@#	
RCa470-PL3#2@*	AR30PL-2@@*&#	
RCa470-PL3#3@*	AR30PL-3@@*&#	
RCa470-Q#@	-	Pull type
RCa470-S1#2	AR30S1R-22#	w/selector ring
RCa470-S2#2	AR30S2R-22#	
RCa470-S3#2	AR30S3R-22#	
RCa470-S4#2	-	
RCa470-S5#2	-	
RCa470-S6#2	AR30S6R-22#	
RCa470-T#1(T)*	AR30Q7L-11*&#	Push-pull
RCa470-UB@	AR30A! -@@@B	Wobble stick type
RCa470-V#@	AR30V0R-@@#	E-stop
RCa470-V1#@	AR30V1R-@@R	
RCa470-V1J#@	-	
RCa470-VJ#@	-	
RCa470-W1#@	-	Lever select
RCa470-W3#@	-	
RCa470-ZK#(T)*	DR30K0L-*&#	Pilot light
RCa470-ZK3#(T)*	-	
RCa470-ZM#(T)*	DR30D0L-*&#	
RCa470-ZM3#(T)*	-	
RCa470-ZN#(T)*	DR30F4M-*&#	
RCa470-ZN1#(T)*	DR30F4N-*&#	
RCa470-ZN2#(T)*	-	
RCa470-ZN3#(T)*	-	
RCa470-ZS#(T)*	-	
RCa470-ZS3#(T)*	-	

## ■ TERMS AND CONDITIONS OF SALE

### Prices

All prices are subject to change without notice. In the event of a price change, the effective date of the change will be the date on the new price or discount schedule sheet.

All quotations made or orders accepted after the effective date will be based on the new prices.

### Quotations

Written quotations are valid for 30 days from its date unless otherwise stated in the quotation. Verbal quotations expire the same day they are made.

### Taxes

The price does not include any taxes. Buyer shall be responsible for the payment of all applicable taxes.

### Terms of payment

Terms of payment will be listed on the quotations.

### Minimum orders

Terms of minimum order will be shown on quotations, or if orders amounting to less than the latest minimum order amount, a handling fee will be applied.

### Delivery

Delivery of products shall be FOB point of origin in the U.S. Seller shall determine the point of origin of shipment. All shipping and other charges shall be paid by Buyer.

### Packing

Prices include standard domestic packing. Additional special packing costs required for export or by Buyer's request will be charged to Buyer.

### Weight and Dimensions

The weight and dimensions of products described in this catalog are the best information available at the time of going to press. As Seller follows a policy of continuous product improvement, design changes may make this information obsolete. Information in this catalog is subject to change without notice.

### Inspection and acceptance of products

Buyer is responsible for evaluating received products or damage for final acceptance. All claims of shortage must be made within thirty (30) days of receipt of products.

### Return / Cancellation

No product shall be returned or canceled unless return/order cancel authorization has been secured from Seller. All returns/cancellations must comply with Seller's then current Return / Cancellation policy.

### Risk of Loss

Risk of loss or damage to the product shall pass to Buyer at the FOB point.

### Catalog Disclaimer

The information contained in this catalog does not constitute an express or implied warranty of quality, any warranty of merchantability or fitness for a particular purpose is hereby disclaimed. Since the Buyer's product information, specific use application, and conditions of use are all outside of Seller's control, it shall be the responsibility of the Buyer to determine the suitability of any of the products mentioned for the Buyer's application.

## ONE YEAR LIMITED WARRANTY

The products identified in this catalog shall be sold pursuant to the terms and conditions identified in the Conditions of Sale issued by Fuji Electric with each order confirmation. Except to the extent otherwise provided for in the Conditions of Sale issued by Fuji Electric, Fuji Electric warrants that the Fuji Electric products identified in this catalog shall be free from significant defects in materials and workmanship provided the products have not been: (1) repaired or altered by others than Fuji Electric; (2) subjected to negligence, accident, misuse, or damage by circumstances beyond Fuji Electric's control; (3) improperly operated, maintained or stored; or (4) used in other than normal use or service. This warranty shall apply only to defects appearing within one (1) year from the date of shipment by Fuji Electric, and in such case, only if such defects are reported to Fuji Electric within thirty (30) days of discovery by purchaser.

Such notice should be submitted in writing to Fuji Electric Corp. of America. The sole and exclusive remedy with respect to the above warranty whether such claim is based on warranty, contract, negligence, strict liability or any other theory, is limited to the repair or replacement of such

product or, at Fuji Electric's option, reimbursement by Fuji Electric of the purchase price paid to Fuji Electric for the particular product.

***FUJI ELECTRIC DOES NOT MAKE ANY OTHER REPRESENTATIONS OR WARRANTIES, WHETHER ORAL OR IN WRITING, EXPRESSED OR IMPLIED, INCLUDING BUT NOT LIMITED TO ANY WARRANTY REGARDING MERCHANTABILITY OR FITNESS FOR A PARTICULAR PURPOSE.***

Except as provided in the Conditions of Sale, no agent or representative of Fuji Electric is authorized to modify the terms of this Warranty in writing or orally.

In no event shall Fuji Electric be liable for special, indirect or consequential damages, including but not limited to, loss of use of the product, other equipment, plant, power system, loss of profits or revenues, cost of capital, or claims against the purchaser or user by its customers resulting from the use of information, recommendations and descriptions contained herein. Purchaser agrees to pass on to its customers and users, in writing at the time inquiries and orders are received by buyer, Fuji Electric's warranty as set forth above.

Your local authorized stocking distributor is:

**FUJI ELECTRIC CORP. OF AMERICA**

Website: [www.fujielectric.com](http://www.fujielectric.com)

**FUJI ELECTRIC (JAPAN)**

Website: [www.fujielectric.co.jp](http://www.fujielectric.co.jp)

**INFORMATION IN THIS CATALOG IS SUBJECT TO CHANGE WITHOUT NOTICE.**

Printed in USA 2008/5M