

TABLE 2		
No OF POS	"A"	"B"
-014	.838 [21.27]	.793 [20.13]
-028	1.625 [41.28]	1.580 [40.13]
-042	2.413 [61.28]	2.368 [60.13]
**056	3.200 [81.28]	3.155 [80.14]
**070	3.988 [101.28]	3.943 [100.14]

** = SEE NOTE 17

TABLE 1	
No OF POS	COPLANARITY INCLUDING GP
-014 THRU -042	.004 [0.10]
**056 THRU **070	.006 [0.15]

** = SEE NOTE 17

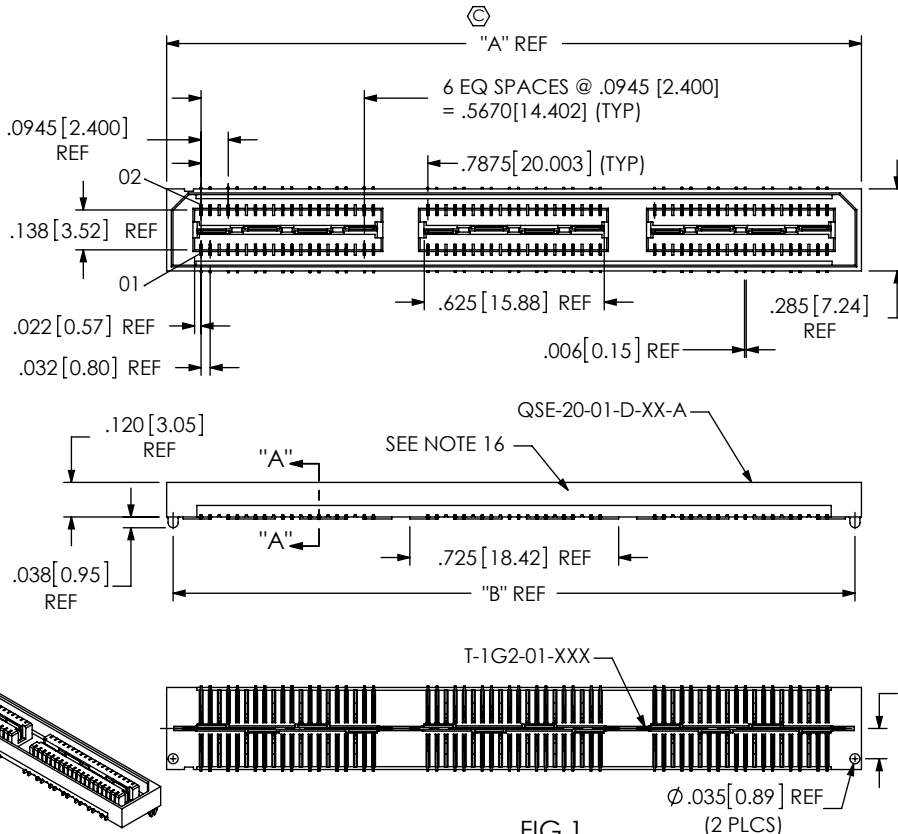

FIG 1

-A: ALIGNMENT PIN OPTION (QSE-042-01-XXX-D-DP-A SHOWN)

- NOTES:
1. © REPRESENTS A CRITICAL DIMENSION.
 2. MINIMUM TERMINAL RETENTION: 5 OZ.
 3. MINIMUM GROUND PLANE RETENTION: 8 OZ.
 4. PARTS TO BE MOLDED TO POSITION.
 5. MAXIMUM VARIANCE: .002 [0.05].
 6. DIMENSION APPLIES TO TERMINALS AND GROUND PLANE.
 7. -L PLATING CAN BE SUBSTITUTED FOR -F PLATING.
 8. GROUND PLANE PRESS HEIGHT MUST BE .003[0.08] LESS THAN THE MAXIMUM HEIGHT OR .001[0.03] GREATER THAN THE MINIMUM HEIGHT OF THE SOCKETS.
 9. SUB-SC-05-01-XX RETENTION TO BE 1.0 LBF IN BODY.
 10. IF ORDERING ALL BANKS DIFFERENTIAL PAIR, LEAVE BLANK. IF ORDERING ALL BANKS STANDARD PIN COUNT, ORDER QSE-XXX-XX-X-D-XXX (STANDARD QSE)
 11. PIN COUNT PER ROW= (# -DP BANKS X 14) + (# -S BANKS X 20)
 12. MAY SUB C-126-01-XXX FOR C-126-21-XXX.
 13. NOTE DELETED.
 14. FOR -056, -070 POSITIONS USE C-269-11-XXX. DO NOT SUB C-126.
 15. DUE TO THE HIGH AMOUNT OF INSERTION FORCE NEEDED, THE -LC OPTION IS NOT COMPATIBLE WITH AUTO PLACEMENT. SAMTEC RECOMMENDS MANUAL PLACEMENT FOR ALL ASSEMBLIES WITH THE -LC OPTION.
 16. SIDE WALLS ARE RIBBED AS NECESSARY TO CONTROL BOW.
 17. AVAILABLE FOR EXISTING CUSTOMERS ONLY.

QSE-XXX-XX-XXX-D-DP-XXX-XXXX

No OF POSITIONS (SEE NOTES 11 & 14)
-014, -028, -042, **056, **070 (PER ROW)
** = SEE NOTE 17

LEAD STYLE
-01: .1280 [3.30]
* -02: .2460 [6.248]

PLATING SPECIFICATION
PLATING THICKNESSES ARE FOR SIGNAL PINS ONLY. FOR GROUND PLANE THICKNESSES, SEE PP-T-1G2-XX-X. (SEE NOTES 7, 12 & 14)
-F: 3µ" SELECTIVE GOLD CONTACT, MATTE TIN TAIL (USE C-126-21-F, T-1G2-01-F)
-L: 10µ" SELECTIVE GOLD CONTACT, MATTE TIN TAIL (USE C-126-21-L, T-1G2-01-L)
-H: 30µ" GOLD CONTACT, 3µ" GOLD TAIL (USE C-126-21-H, T-1G2-01-G)
-C: 50µ" ELECTRO POLISHED SELECTIVE GOLD CONTACT, MATTE TIN TAIL (USE C-126-21-C, T-1G2-01-L)
-STL: 30µ" SELECTIVE GOLD CONTACT, TIN LEAD (90/10 ±5%) TAILS (USE C-126-21-STL, T-1G2-01-STL)
-FTL: 3µ" SELECTIVE GOLD CONTACT, TIN LEAD (90/10 ±5%) TAILS (USE C-126-21-FTL, T-1G2-01-FTL)
-S: 30µ" SELECTIVE GOLD CONTACT, MATTE TIN TAIL (USE C-126-21-S, T-1G2-01-L)

PIN COUNT, BANKS 1-5 (SEE NOTE 11)
-S: STANDARD
-D: DIFFERENTIAL (SEE NOTE 10 & FIG 6, SHT 4)

OPTION
-A: ALIGNMENT PINS (USE QSE-20-01-D-XX-A) (NOT AVAILABLE WITH -LC)
-LC: LOCKING CLIPS (SEE NOTE 15) (USE LC-08-TM-01, SEE FIG 2, SHT 2) (NOT AVAILABLE WITH -A)
-K: POLYIMIDE FILM (USE K-DOT-.325-.450-.005, SEE FIG 3, SHT 2)
-TR: TAPE & REEL (42 POS MAX) (28 POS MAX FOR -GP)
-GP: GUIDE POSTS (USE QSE-20-XX-D-GP, SEE FIG 4, SHT 3)
-RT1: RETENTION (MUST USE -A OPTION) (USE QSE-20-01-D-XX-A-RT1 & SUB-SC-05-01-FF) (SEE FIG 5, SHT 3) (NOT AVAILABLE WITH -LC OR -GP) (NOT AVAILABLE IN 056 OR 070 POS)
-L: LATCHING OPTION (28 POS MAX) (SEE FIG 8, SHT 4) (MUST USE -A OPTION) (NOT AVAILABLE WITH -LC, -GP, -FL, OR -RT1)

BODY STYLE
-DP: DIFFERENTIAL PAIRS

ROW SPECIFICATION
-D: DOUBLE (USE QSE-20-01-D-XX)

* = NOT TOOLED

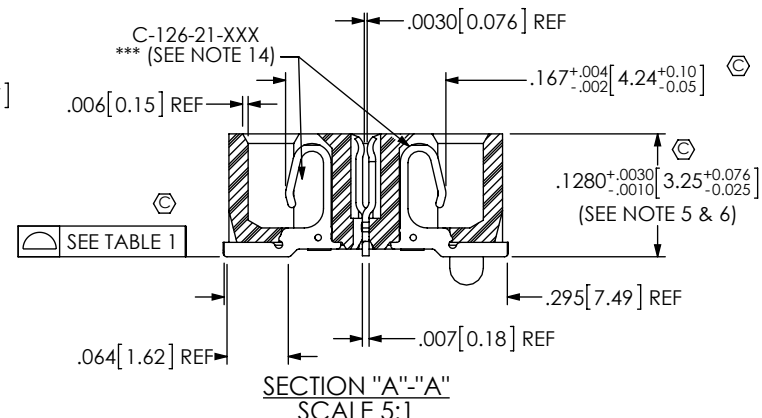

UNLESS OTHERWISE SPECIFIED, DIMENSIONS ARE IN INCHES. TOLERANCES ARE: DECIMALS .XX: ±.01 [0.25] .XXX: ±.005 [0.13] .XXXX: ±.0020 [0.05]		PROPRIETARY NOTE THIS DOCUMENT CONTAINS CONFIDENTIAL AND PROPRIETARY INFORMATION AND ALL DESIGN, MANUFACTURING, REPRODUCTION, USE, PATENT RIGHTS AND SALES RIGHTS ARE EXPRESSLY RESERVED BY SAMTEC, INC. THIS DOCUMENT SHALL NOT BE DISCLOSED, IN WHOLE OR PART, TO ANY UNAUTHORIZED PERSON OR ENTITY NOR REPRODUCED, TRANSFERRED OR INCORPORATED IN ANY OTHER PROJECT IN ANY MANNER WITHOUT THE EXPRESS WRITTEN CONSENT OF SAMTEC, INC.	<p>520 PARK EAST BLVD, NEW ALBANY, IN 47150 PHONE: 812-944-6733 FAX: 812-948-5047 e-Mail info@SAMTEC.com code 5322</p>
MATERIAL: DO NOT SCALE DRAWING	SHEET SCALE: 1.5:1	DESCRIPTION: .8mm DIFFERENTIAL PAIRS HS SOCKET ASSEMBLY	
INSULATOR: LCP, UL94V0; COLOR: BLACK CONTACT: PHOS BRONZE GROUND PLANE: PHOS BRONZE		DWG. NO. QSE-XXX-XX-XXX-D-DP-XXX-XXXX	
BY: DEAN P 5/05/2000		SHEET 1 OF 4	

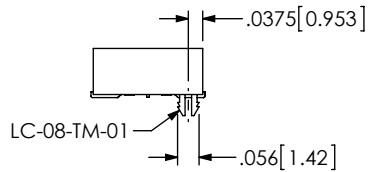
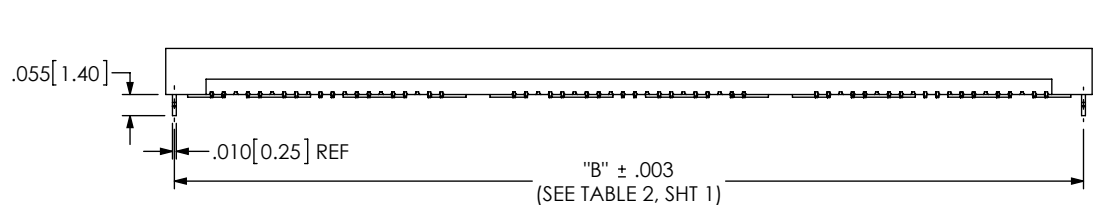

FIG 2
 -LC: LOCKING CLIP OPTION
 (QSE-042-01-XXX-D-DP-LC SHOWN)
 (DIFFERENT AS SHOWN, OTHERWISE SAME AS FIG 1)

TABLE 3

No OF POS	"R"				"S"			
	-LC, -A	-GP	-RT	-L	-LC, -A	-GP	-RT	-L
-014	.838 [21.27]	1.216 [30.88]	1.438 [36.51]	1.048 [26.61]	.256 [6.51]	.445 [11.31]	.556 [14.13]	.361 [9.18]
-028	1.625 [41.28]	2.003 [50.89]	2.225 [56.52]	1.835 [46.61]	.650 [16.51]	.839 [21.32]	.950 [24.13]	.755 [19.18]
-042	2.413 [61.28]	2.791 [70.89]	3.013 [76.52]	2.623 [66.61]	1.044 [26.51]	1.233 [31.32]	1.344 [34.13]	1.149 [29.18]
**-.056	3.200 [81.28]	3.578 [90.89]	N/A	3.410 [86.61]	1.438 [36.51]	1.627 [41.32]	N/A	1.543 [39.18]
**-.070	3.988 [101.28]	4.366 [110.89]	N/A	4.198 [106.62]	1.831 [46.51]	2.020 [51.32]	N/A	1.936 [49.18]

** = SEE NOTE 17

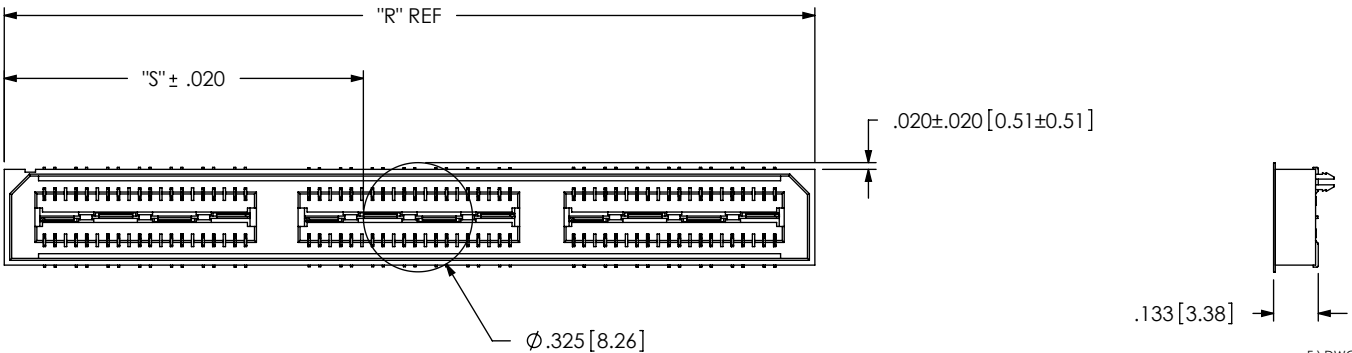

FIG 3
 -K: POLYIMIDE FILM PAD
 (USE K-DOT-.325-.450-.005)

F:\DWG\MISC\MKTG\QSE-XXX-XX-XXX-D-DP-XXX-XXXXX-MKT.SLDDRW

PROPRIETARY NOTE
 THIS DOCUMENT CONTAINS CONFIDENTIAL AND PROPRIETARY INFORMATION AND ALL DESIGN, MANUFACTURING, REPRODUCTION, USE, PATENT RIGHTS AND SALES RIGHTS ARE EXPRESSLY RESERVED BY SAMTEC, INC. THIS DOCUMENT SHALL NOT BE DISCLOSED, IN WHOLE OR PART, TO ANY UNAUTHORIZED PERSON OR ENTITY NOR REPRODUCED, TRANSFERRED OR INCORPORATED IN ANY OTHER PROJECT IN ANY MANNER WITHOUT THE EXPRESS WRITTEN CONSENT OF SAMTEC, INC.



520 PARK EAST BLVD, NEW ALBANY, IN 47150
 PHONE: 812-944-6733 FAX: 812-948-5047
 e-Mail info@SAMTEC.com code 55322

DO NOT SCALE DRAWING

SHEET SCALE: 2:1

DESCRIPTION:
 .8mm DIFFERENTIAL PAIRS HS SOCKET ASSEMBLY

DWG. NO.
 QSE-XXX-XX-XXX-D-DP-XXX-XXXXX

BY: DEAN P 5/05/2000 SHEET 2 OF 4

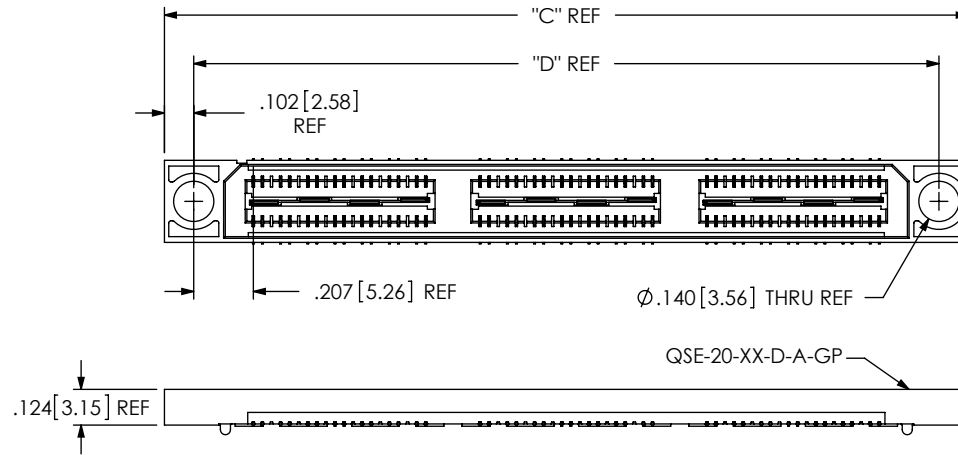

FIG 4
 -GP OPTION
 (QSE-042-01-XXX-D-DP-GP SHOWN)
 (DIFFERENT AS SHOWN, OTHERWISE SAME AS FIG 1)
 (AVAILABLE ON LEAD STYLES -01 & -01-A ONLY)
 (28 POSITION MAX FOR TAPE & REEL PACKAGING)

No OF POS	"C"	"D"
-014	1.216 [30.88]	1.013 [25.73]
-028	2.003 [50.89]	1.801 [45.73]
-042	2.791 [70.89]	2.588 [65.74]
** -056	3.578 [90.89]	3.376 [85.74]
** -070	4.366 [110.89]	4.163 [105.74]

** = SEE NOTE 17

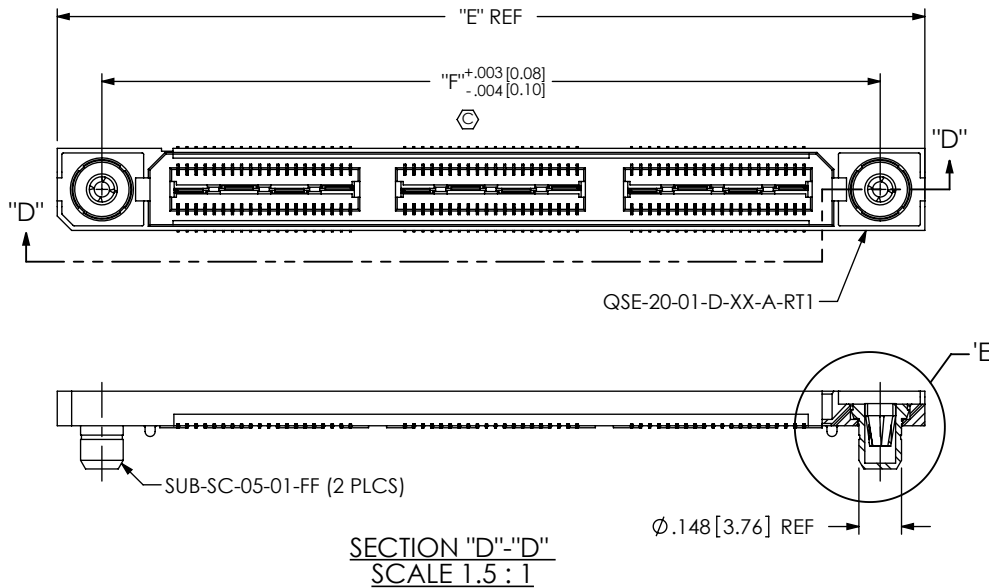
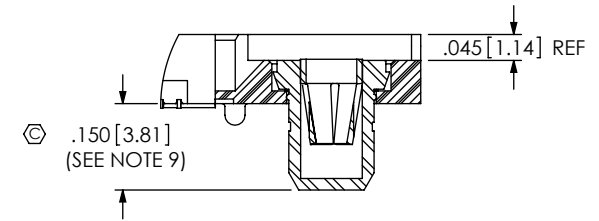



FIG 5
 -RT1: RETENTION OPTION
 (QSE-042-01-XXX-D-DP-A-RT1 SHOWN)
 (DIFFERENT AS SHOWN, OTHERWISE SAME AS FIG 1)
 (MUST USE -A OPTION)
 (NOT AVAILABLE WITH -LC OR -GP OPTIONS)
 (NOT AVAILABLE WITH ** -056 & ** -070)

No OF POS	"E"	"F"
-014	1.438 [36.51]	1.129 [28.66]
-028	2.225 [56.52]	1.916 [48.67]
-042	3.013 [76.52]	2.704 [68.67]
** -056	N/A	N/A
** -070	N/A	N/A

** = SEE NOTE 17



DETAIL 'E'
 SCALE 3:1

<p>* PROPRIETARY NOTE</p> <p>THIS DOCUMENT CONTAINS CONFIDENTIAL AND PROPRIETARY INFORMATION AND ALL DESIGN, MANUFACTURING, REPRODUCTION, USE, PATENT RIGHTS AND SALES RIGHTS ARE EXPRESSLY RESERVED BY SAMTEC, INC. THIS DOCUMENT SHALL NOT BE DISCLOSED, IN WHOLE OR PART, TO ANY UNAUTHORIZED PERSON OR ENTITY NOR REPRODUCED, TRANSFERRED OR INCORPORATED IN ANY OTHER PROJECT IN ANY MANNER WITHOUT THE EXPRESS WRITTEN CONSENT OF SAMTEC, INC.</p> <p>DO NOT SCALE DRAWING</p> <p>SHEET SCALE: 2:1</p>	 <p>520 PARK EAST BLVD. NEW ALBANY, IN 47150 PHONE: 812-944-6733 FAX: 812-948-5047 e-Mail: info@SAMTEC.com code 55322</p>	
	<p>DESCRIPTION: .8mm DIFFERENTIAL PAIRS HS SOCKET ASSEMBLY</p>	
	<p>DWG. NO. QSE-XXX-XX-XXX-D-DP-XXX-XXXXX</p>	
	<p>BY: DEAN P</p>	<p>5/05/2000</p>

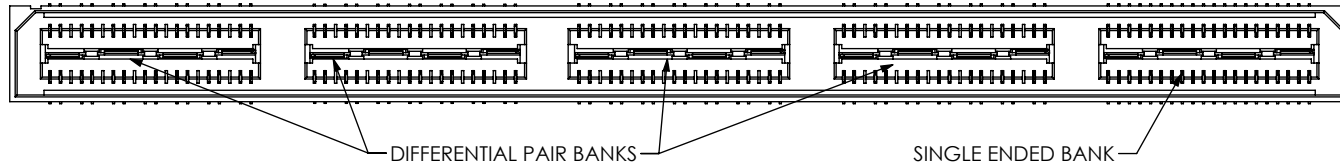

FIG 6
 (**QSE-070-01-XXX-D-DP-A-DDDD)
 (** = SEE NOTE 17)

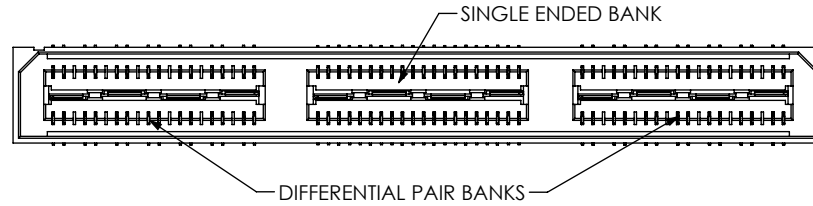
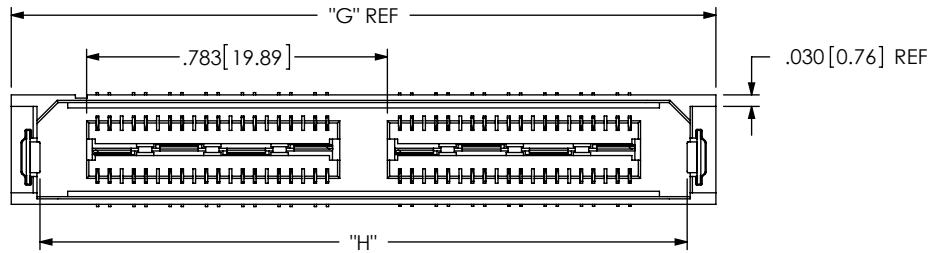

FIG 7
 (QSE-042-01-XXX-D-DP-A-DSD SHOWN)



No OF POS	"G"	"H"	"J"
-014	1.048 [26.61]	.898 [22.80]	.960 [24.38]
-028	1.835 [46.61]	1.685 [42.80]	1.747 [44.37]
-042	N/A	N/A	N/A
**_056	N/A	N/A	N/A
**_070	N/A	N/A	N/A

** = SEE NOTE 17

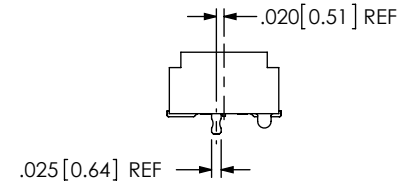
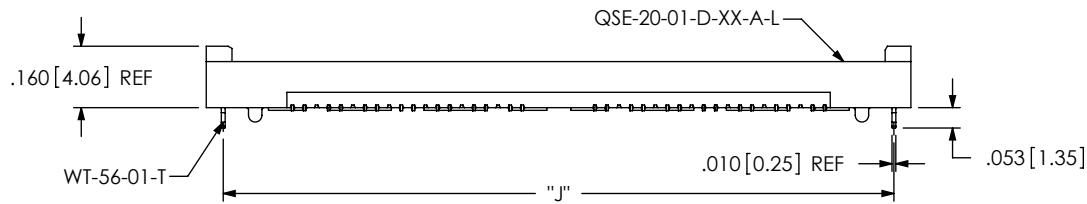

FIG 8
 -L: LATCHING OPTION
 (QSE-020-01-XXX-D-DP-A-L SHOWN)
 (DIFFERENT AS SHOWN, OTHERWISE SAME AS FIG 1)
 (MUST USE -A OPTION) (MAXIMUM 28 POS)
 (NOT AVAILABLE WITH -LC, -GP, -FL, OR -RT1)

CRITICAL DIMENSION INSPECTION INSTRUCTION TABLE

ASSEMBLY OPERATION	IN-PROCESS INSPECTION
FILL C-126-21	C1, C3, C12
ADD -RT1 OPTION	C4, C6
ADD -L OPTION	C7, C8, C9, C15
ADD -K OPTION	C10, C11

PROPRIETARY NOTE
 THIS DOCUMENT CONTAINS CONFIDENTIAL AND PROPRIETARY INFORMATION AND ALL DESIGN, MANUFACTURING, REPRODUCTION, USE, PATENT RIGHTS AND SALES RIGHTS ARE EXPRESSLY RESERVED BY SAMTEC, INC. THIS DOCUMENT SHALL NOT BE DISCLOSED, IN WHOLE OR PART, TO ANY UNAUTHORIZED PERSON OR ENTITY NOR REPRODUCED, TRANSFERRED OR INCORPORATED IN ANY OTHER PROJECT IN ANY MANNER WITHOUT THE EXPRESS WRITTEN CONSENT OF SAMTEC, INC.

DO NOT SCALE DRAWING
 SHEET SCALE: 1.375:1

520 PARK EAST BLVD, NEW ALBANY, IN 47150
 PHONE: 812-944-6733 FAX: 812-948-5047
 e-Mail: info@SAMTEC.com code 55322

DESCRIPTION:
 .8mm DIFFERENTIAL PAIRS HS SOCKET ASSEMBLY
 DWG. NO.
 QSE-XXX-XX-XXX-D-DP-XXX-XXXXX
 BY: DEAN P 5/05/2000 SHEET 4 OF 4