

PM-44 SERIES PM-54 SERIES

Related Information

- General terms and conditions F-13
- Sensor selection guide P.427~
- Glossary of terms / General precautions P.1455~ / P.1458~
- Korea's S-mark P.1506

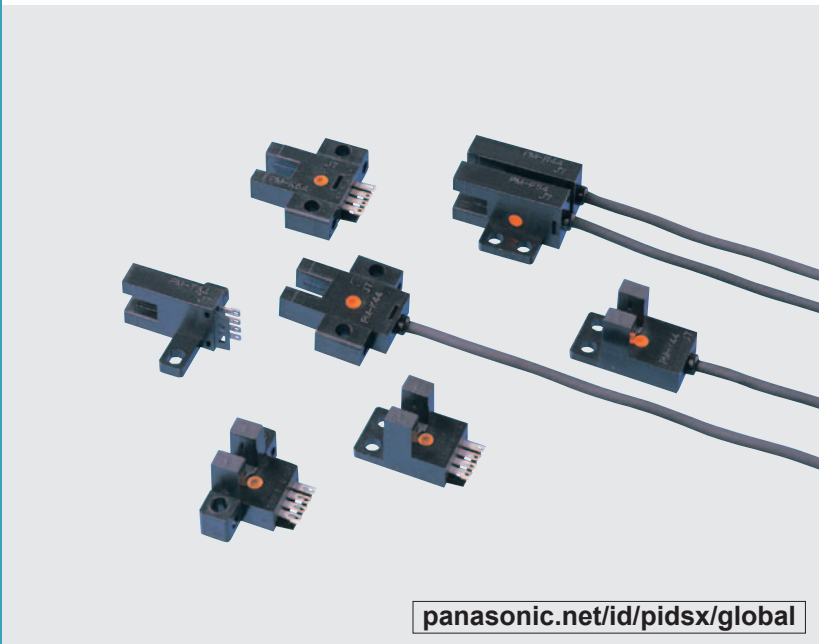

Enables space saving and quick installation!

Equipped with two independent outputs

All models are equipped with two independent outputs Light-ON and Dark-ON. Hence, one model suffices even if the output is to be used differently, depending upon the location of use. Also, since two independent outputs have been provided, cumbersome handling of the output conversion control input, or fear of logic inversion due to a cable break, is eliminated. The sensor can be connected to the existing wiring as it is.

Example of connection with a commercial intermediate connector

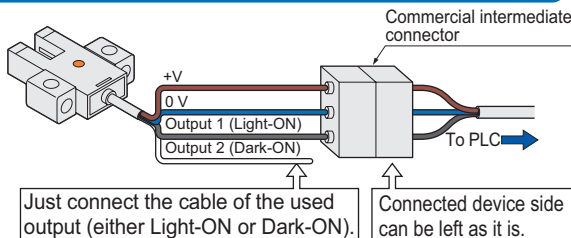

Note: Ensure to insulate the unused output wire.

Quick fitting hook-up connector

Easy to maintain connector type models are available. Its exclusive connector is the hook-up connector. Since only crimping with exclusive pliers is to be done, cumbersome soldering or insulation is absolutely not required. Further, connector attached cable is also available.

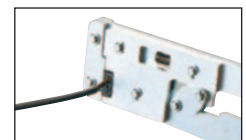

Crimp the connector on the cable.

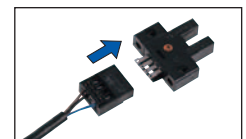

Quick connection to the sensor.

APPLICATIONS

Sensing the starting point and overrun of a moving body

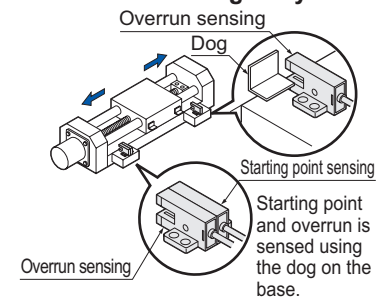

- FIBER SENSORS
- LASER SENSORS
- PHOTOELECTRIC SENSORS
- MICRO PHOTOELECTRIC SENSORS
- AREA SENSORS
- LIGHT CURTAINS / SAFETY COMPONENTS
- PRESSURE / FLOW SENSORS
- INDUCTIVE PROXIMITY SENSORS
- PARTICULAR USE SENSORS
- SENSOR OPTIONS
- SIMPLE WIRE- SAVING UNITS
- WIRE- SAVING SYSTEMS
- MEASUREMENT SENSORS
- STATIC ELECTRICITY PREVENTION DEVICES
- LASER MARKERS
- PLC
- HUMAN MACHINE INTERFACES
- ENERGY CONSUMPTION VISUALIZATION COMPONENTS
- FA COMPONENTS
- MACHINE VISION SYSTEMS
- UV CURING SYSTEMS

- Selection Guide
- U-shaped
- Convergent Reflective
- PM-64
- PM-24
- PM-44/PM-54

Wide model variety

A wide variety of 12 shapes and 24 models is available. You may select from this wide range to suit the mounting conditions.

Meets global requirements

Conforms to Europe's EMC Directive and obtains UL Recognition. The NPN output type with cable (excluding 3 m 9.843 ft cable length type) has also obtained Korea's S-mark certification. Both, NPN and PNP output models are available.

ORDER GUIDE

Type	Appearance (mm in)	Sensing range	Model No.	Output	Output operation	
Small	With cable	5 mm 0.197 in (fixed)	K type	PM-K44	NPN open-collector transistor	Incorporated with 2 outputs: Light-ON / Dark-ON
			T type	PM-T44	NPN open-collector transistor	
			L type	PM-L44	NPN open-collector transistor	
			Y type	PM-Y44	NPN open-collector transistor	
			F type	PM-F44	NPN open-collector transistor	
			R type	PM-R44	NPN open-collector transistor	
	With connector		K type	PM-K54	NPN open-collector transistor	
			T type	PM-T54	NPN open-collector transistor	
			L type	PM-L54	NPN open-collector transistor	
			Y type	PM-Y54	NPN open-collector transistor	
			F type	PM-F54	NPN open-collector transistor	
			R type	PM-R54	NPN open-collector transistor	
			PM-K44P	PNP open-collector transistor		
			PM-T44P	PNP open-collector transistor		
			PM-L44P	PNP open-collector transistor		
			PM-Y44P	PNP open-collector transistor		
			PM-F44P	PNP open-collector transistor		
			PM-R44P	PNP open-collector transistor		
			PM-K54P	PNP open-collector transistor		
			PM-T54P	PNP open-collector transistor		
			PM-L54P	PNP open-collector transistor		
			PM-Y54P	PNP open-collector transistor		
			PM-F54P	PNP open-collector transistor		
			PM-R54P	PNP open-collector transistor		

FIBER SENSORS

LASER SENSORS

PHOTO-ELECTRIC SENSORS

MICRO PHOTO-ELECTRIC SENSORS

AREA SENSORS

LIGHT CURTAINS / SAFETY COMPONENTS

PRESSURE / FLOW SENSORS

INDUCTIVE PROXIMITY SENSORS

PARTICULAR USE SENSORS

SENSOR OPTIONS

WIRE-SAVING UNITS

WIRE-SAVING SYSTEMS

MEASUREMENT SENSORS

STATIC ELECTRICITY PREVENTION DEVICES

LASER MARKERS

PLC

HUMAN MACHINE INTERFACES

ENERGY CONSUMPTION VISUALIZATION COMPONENTS

FA COMPONENTS

MACHINE VISION SYSTEMS

UV CURING SYSTEMS

Selection Guide

U-shaped

Convergent Reflective

PM-64

PM-24

PM-44/PM-54

FIBER SENSORS

LASER SENSORS

PHOTO-ELECTRIC SENSORS

MICRO PHOTO-ELECTRIC SENSORS

AREA SENSORS

LIGHT CURTAINS / SAFETY COMPONENTS

PRESSURE / FLOW SENSORS

INDUCTIVE PROXIMITY SENSORS

PARTICULAR USE SENSORS

SENSOR OPTIONS

SIMPLE WIRE-SAVING UNITS

WIRE-SAVING SYSTEMS

MEASUREMENT SENSORS

STATIC ELECTRICITY PREVENTION DEVICES

LASER MARKERS

PLC

HUMAN MACHINE INTERFACES

ENERGY CONSUMPTION VISUALIZATION COMPONENTS

FA COMPONENTS

MACHINE VISION SYSTEMS

UV CURING SYSTEMS

Selection Guide

U-shaped

Convergent Reflective

PM-64

PM-24

PM-44/
PM-54

ORDER GUIDE

3 m 9.843 ft cable length type

3 m 9.843 ft cable length type (standard: 1 m 3.281 ft) is also available. When ordering this type, suffix "-C3" to the model No. (e.g.) 3m 9.843 ft cable length type of PM-K44 is "PM-K44-C3".

OPTIONS

Designation	Model No.	Description	
Connector	CN-14	Connector for soldering	
Hook-up connector	CN-14H	This connector can be hooked-up on 0.08 to 0.2 mm ² cable simply in one grip. Wire diameter: $\varnothing 0.7$ to $\varnothing 1.2$ mm $\varnothing 0.028$ to $\varnothing 0.047$ in	
	CN-14H-2	Suitable for UL standard cable. This connector can be hooked-up on 0.18 to 0.22 mm ² cable simply in one grip. Wire diameter: $\varnothing 1.2$ to $\varnothing 1.52$ mm $\varnothing 0.047$ to $\varnothing 0.060$ in	
Connector attached cable	CN-14H-C1	Length: 1 m 3.281 ft Net weight: 20 g approx.	For the connector type, with 0.2 mm ² 4-core cabtyre cable Cable diameter: $\varnothing 3.7$ mm $\varnothing 0.146$ in
	CN-14H-C3	Length: 3 m 9.843 ft Net weight: 65 g approx.	
Hook-up pliers	CN-HP	These are exclusive pliers for hook-up connectors CN-14H and CN-14H-2 .	

Connector

- CN-14

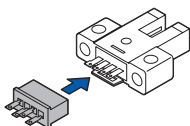

Hook-up connector

- CN-14H
- CN-14H-2

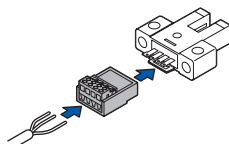

Connector attached cable

- CN-14H-C1
- CN-14H-C3

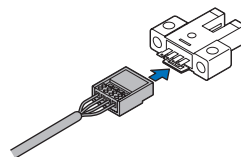

Hook-up pliers

- CN-HP

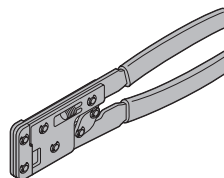

SPECIFICATIONS

Item	Model No.	Type	Small	
			With cable	With connector
			NPN output	PM-□44
PNP output	PM-□44P	PM-□54P		
Sensing range	5 mm 0.197 in (fixed)			
Minimum sensing object	0.8 × 1.8 mm 0.031 × 0.071 in opaque object			
Hysteresis	0.05 mm 0.002 in or less			
Repeatability	0.03 mm 0.001 in or less			
Supply voltage	5 to 24 V DC ±10 % Ripple P-P 10 % or less			
Current consumption	15 mA or less			
Output	<NPN output type> NPN open-collector transistor		<PNP output type> PNP open-collector transistor	
	<ul style="list-style-type: none"> Maximum sink current: 50 mA Applied voltage: 30 V DC or less (between output and 0 V) Residual voltage: 0.7 V or less (at 50 mA sink current) 0.4 V or less (at 16 mA sink current) 		<ul style="list-style-type: none"> Maximum source current: 50 mA Applied voltage: 30 V DC or less (between output and +V) Residual voltage: 0.7 V or less (at 50 mA source current) 0.4 V or less (at 16 mA source current) 	
	Utilization category	DC-12 or DC-13		
Output operation	Incorporated with 2 outputs: Light-ON / Dark-ON			
Response time	Under light received condition: 20 μs or less, Under light interrupted condition: 100 μs or less (Response frequency: 1 kHz or more) (Note 2)			
Operation indicator	Vermilion LED (lights up under light received condition)			
Environmental resistance	Pollution degree	3 (Industrial environment)		
	Ambient temperature	-25 to +55 °C -13 to +131 °F (No dew condensation or icing allowed), Storage: -30 to +80 °C -22 to +176 °F		
	Ambient humidity	35 to 85 % RH, Storage: 35 to 85 % RH		
	Ambient illuminance	Fluorescent light: 1,000 lx at the light-receiving face		
	EMC	EN 60947-5-2		
	Voltage withstandability	1,000 V AC for one min. between all supply terminals connected together and enclosure		
	Insulation resistance	50 MΩ, or more, with 250 V DC megger between all supply terminals connected together and enclosure		
	Vibration resistance	10 to 2,000 Hz frequency, 1.5 mm 0.059 in amplitude in X, Y and Z directions for two hours each		
	Shock resistance	15,000 m/s ² acceleration (1,500 G approx.) in X, Y and Z directions for three times each		
Emitting element	Infrared LED (Peak emission wavelength: 940 nm 0.037 mil, non-modulated)			
Material	Enclosure: PBT, Slit cover: Polycarbonate, Terminal part [PM-□54(P) only]: Solder plated			
Cable	0.09 mm ² 4-core cabtyre cable, 1 m 3.281 ft long	_____		
Cable extension	Extension up to total 100 m 328.084 ft is possible with 0.3 mm ² , or more, cable.			
Weight	Net weight: 15 g approx.	Net weight: 3 g approx.		

Notes: 1) Where measurement conditions have not been specified precisely, the conditions used were an ambient temperature of +23 °C +73.4 °F.
2) The response frequency is the value when the disc, given in the figure below, is rotated.

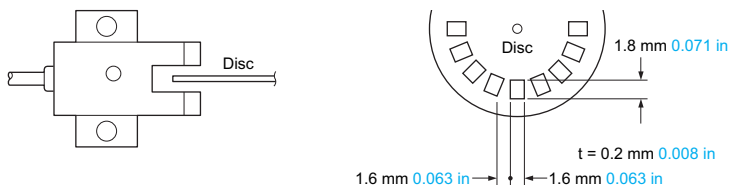

FIBER SENSORS

LASER SENSORS

PHOTO-ELECTRIC SENSORS

MICRO PHOTO-ELECTRIC SENSORS

AREA SENSORS

LIGHT CURTAINS / SAFETY COMPONENTS

PRESSURE / FLOW SENSORS

INDUCTIVE PROXIMITY SENSORS

PARTICULAR USE SENSORS

SENSOR OPTIONS

SIMPLE WIRE-SAVING UNITS

WIRE-SAVING SYSTEMS

MEASUREMENT SENSORS

STATIC ELECTRICITY PREVENTION DEVICES

LASER MARKERS

PLC

HUMAN MACHINE INTERFACES

ENERGY CONSUMPTION VISUALIZATION COMPONENTS

FA COMPONENTS

MACHINE VISION SYSTEMS

UV CURING SYSTEMS

Selection Guide

U-shaped

Convergent Reflective

PM-64

PM-24

PM-44/ PM-54

FIBER SENSORS
 LASER SENSORS
 PHOTO-ELECTRIC SENSORS
 MICRO PHOTO-ELECTRIC SENSORS
 AREA SENSORS
 LIGHT CURTAINS/ SAFETY COMPONENTS
 PRESSURE / FLOW SENSORS
 INDUCTIVE PROXIMITY SENSORS
 PARTICULAR USE SENSORS
 SENSOR OPTIONS
 SIMPLE WIRE-SAVING UNITS
 WIRE-SAVING SYSTEMS
 MEASURE-MENT SENSORS
 STATIC ELECTRICITY PREVENTION DEVICES
 LASER MARKERS
 PLC
 HUMAN MACHINE INTERFACES
 ENERGY CONSUMPTION VISUALIZATION COMPONENTS
 FA COMPONENTS
 MACHINE VISION SYSTEMS
 UV CURING SYSTEMS
 Selection Guide
 U-shaped
 Convergent Reflective
PM-64
PM-24
PM-44/ PM-54

I/O CIRCUIT AND WIRING DIAGRAMS

PM-□44 PM-□54 NPN output type

I/O circuit diagram

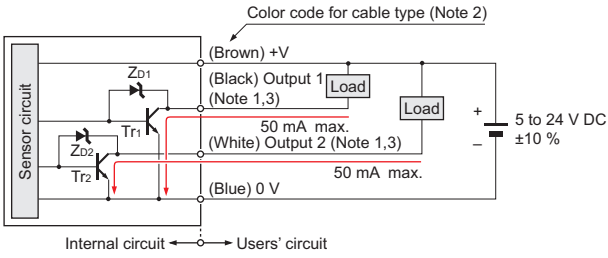

Notes: 1) Make sure to connect terminals correctly as the sensor does not incorporate a reverse polarity protection circuit. Further, the output is not incorporated with a short-circuit protection circuit. Do not connect it directly to a power supply or a capacitive load. Faulty wiring may result in damage.
 2) The color code of the connector attached cable is also the same.
 3) Ensure to insulate the unused output wire.

Symbols ... ZD1, ZD2: Surge absorption zener diode
 Tr1, Tr2 : NPN output transistor

Wiring diagram

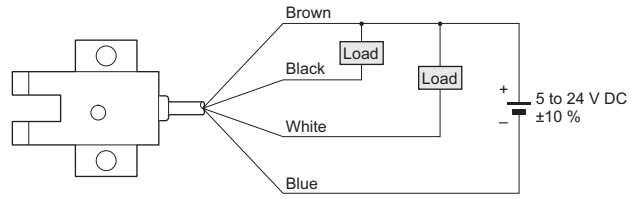

Output operation

	Color code	Output operation
Output 1	Black	Light-ON
Output 2	White	Dark-ON

PM-□44P PM-□54P PNP output type

I/O circuit diagram

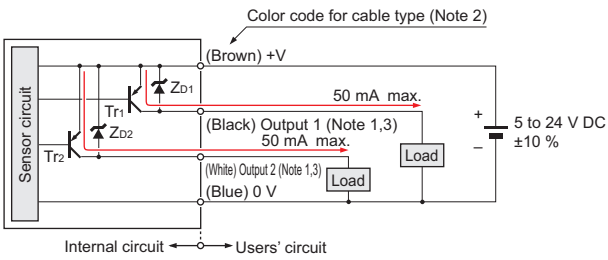

Notes: 1) Make sure to connect terminals correctly as the sensor does not incorporate a reverse polarity protection circuit. Further, the output is not incorporated with a short-circuit protection circuit. Do not connect it directly to a power supply or a capacitive load. Faulty wiring may result in damage.
 2) The color code of the connector attached cable is also the same.
 3) Ensure to insulate the unused output wire.

Symbols ... ZD1, ZD2: Surge absorption zener diode
 Tr1, Tr2 : PNP output transistor

Wiring diagram

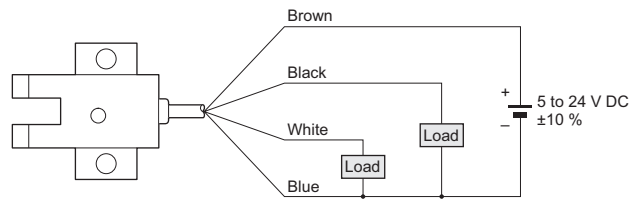

Output operation

	Color code	Output operation
Output 1	Black	Light-ON
Output 2	White	Dark-ON

SENSING CHARACTERISTICS (TYPICAL)

PM-L44(P)/K44(P) PM-L54(P)/K54(P)

Sensing position

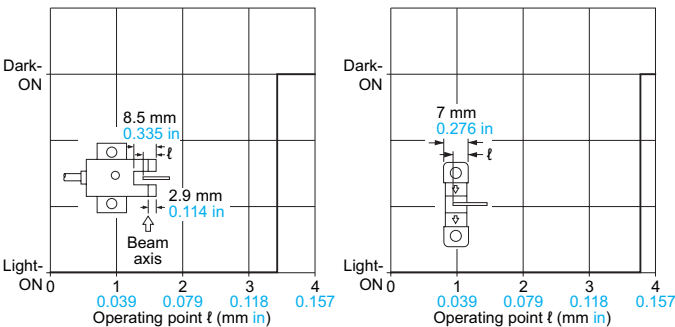

PRECAUTIONS FOR PROPER USE

Refer to p.1458~ for general precautions.

All models



- Never use this product as a sensing device for personnel protection.
- In case of using sensing devices for personnel protection, use products which meet laws and standards, such as OSHA, ANSI or IEC etc., for personnel protection applicable in each region or country.



Make sure to connect terminals correctly as the sensor does not incorporate a reverse polarity protection circuit. Further, the output is not incorporated with a short-circuit protection circuit. Do not connect it directly to a power supply or a capacitive load. Faulty wiring may result in damage.

Mounting

- When fixing the sensor with screws, use M3 screws and the tightening torque should not exceed the values given below. Further, use small, round type plain washers (ø6 mm ø0.236 in).

Model No.	Tightening torque
PM-□44(P)	0.5 N·m
PM-□54(P)	

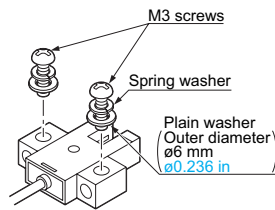

Cable extension

- Cable extension is possible up to an overall length of 100 m 328.084 ft with a 0.3 mm², or more, cable. However, since a voltage drop shall occur due to the cable extension, ensure that the power supply voltage at the end of the cable attached to the sensor or at the sensor terminals is within the rating.

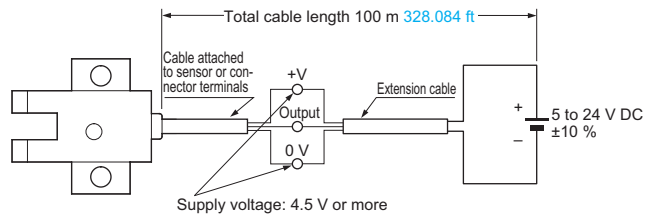

But, when the overall cable length, including the cable attached to the sensor, is as given below, there is no need to confirm the voltage.

Conductor cross-section area of extension cable	Total cable length
0.08 to 0.1 mm ²	Up to 5 m 16.404 ft
0.2 mm ²	Up to 10 m 32.808 ft
0.3 mm ²	Up to 20 m 65.617 ft

Others

- Since the sensor is intended for use inside machines, no special countermeasures have been taken against extraneous light. Take care that extraneous light is not directly incident on the beam receiving section.
- Do not use during the initial transient time (50 ms) after the power supply is switched on.

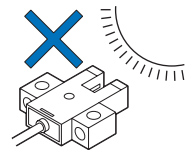

FIBER SENSORS

LASER SENSORS

PHOTO-ELECTRIC SENSORS

MICRO PHOTO-ELECTRIC SENSORS

AREA SENSORS

LIGHT CURTAINS / SAFETY COMPONENTS

PRESSURE / FLOW SENSORS

INDUCTIVE PROXIMITY SENSORS

PARTICULAR USE SENSORS

SENSOR OPTIONS

SIMPLE WIRE-SAVING UNITS

WIRE-SAVING SYSTEMS

MEASUREMENT SENSORS

STATIC ELECTRICITY PREVENTION DEVICES

LASER MARKERS

PLC

HUMAN MACHINE INTERFACES

ENERGY CONSUMPTION VISUALIZATION COMPONENTS

FA COMPONENTS

MACHINE VISION SYSTEMS

UV CURING SYSTEMS

Selection Guide

U-shaped

Convergent Reflective

PM-64

PM-24

PM-44/PM-54

FIBER SENSORS
LASER SENSORS
PHOTO-ELECTRIC SENSORS
MICRO PHOTO-ELECTRIC SENSORS
AREA SENSORS
LIGHT CURTAINS/SAFETY COMPONENTS
PRESSURE / FLOW SENSORS
INDUCTIVE PROXIMITY SENSORS
PARTICULAR USE SENSORS
SENSOR OPTIONS
SIMPLE WIRE-SAVING UNITS
WIRE-SAVING SYSTEMS
MEASUREMENT SENSORS
STATIC ELECTRICITY PREVENTION DEVICES
LASER MARKERS
PLC
HUMAN MACHINE INTERFACES
ENERGY CONSUMPTION VISUALIZATION COMPONENTS
FA COMPONENTS
MACHINE VISION SYSTEMS
UV CURING SYSTEMS

PRECAUTIONS FOR PROPER USE

Refer to p.1458~ for general precautions.

PM-□54 PM-□54P

Cautions in plugging or unplugging a connector



- Do not plug or unplug a connector more than 10 times.
- Be sure not to give stress more than 5 N to a terminal of both a connector and a sensor. If you do not follow the above cautions, it will cause a poor contact.

Procedures of plugging or unplugging a connector

① Insert a connector straight into a sensor until the connector lug is locked by the sensor hook.

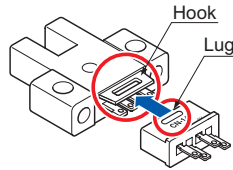

② When unplugging, give as much stress as a connector lug can be relieved from a hook. Then unplug it.

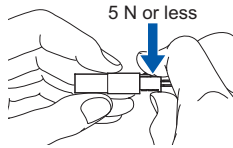

Caution: Be sure to hold a connector when plugging or unplugging it. Do not hold a terminal or a cable when plugging or unplugging the connector. Otherwise, it will cause a poor contact.

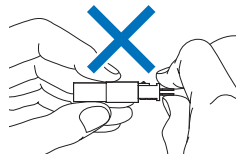

Soldering (Both connector CN-14 and sensor)

- If soldering is done directly on the terminals, strictly adhere to the conditions given below.

Soldering temperature	260 °C 500 °F or less
Soldering time	3 sec. or less
Soldering position	Refer to the below figure

Sensor

Connector

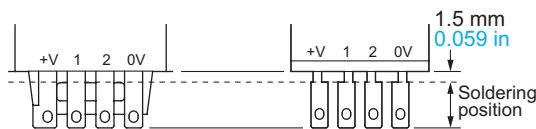

Crimping of hook-up connectors CN-14H and CN-14H-2

Model No.	CN-14H	CN-14H-2
Item		
Conductor cross-section area	0.08 to 0.2 mm ² (AWG28 to AWG24)	0.18 to 0.22 mm ² (AWG25 to AWG24)
Wire diameter	ø0.7 to ø1.2 mm ø0.028 to ø0.047 in	ø1.2 to ø1.52 mm ø0.047 to ø0.060 in
Wire insulation material	Vinyl chloride or soft polyethylene	

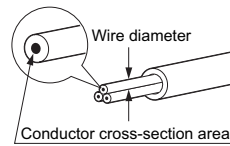

Crimping method

① Strip the cable sheath 15 mm 0.591 in, or more, and insert the wires into the connector insertion holes till the wire tips reach the end.

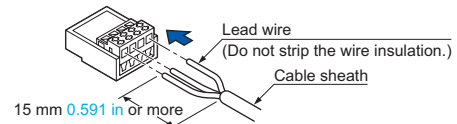

Arrangement of connector terminals

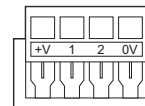

+V: +V
1: Output 1 (Light-ON)
2: Output 2 (Dark-ON) } (Note) Power supply
0V: 0 V

Note: Wire at Pin No.1 or 2 as per requirement.

② Crimp with the exclusive hook-up pliers **CN-HP**.

- Notes: 1) When attaching or detaching the connector fitted with a cable, make sure to hold the connector firmly before proceeding.
2) After crimping, do not pull on the cable.

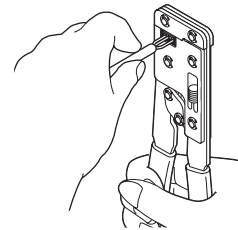

Caution: Make sure to use the exclusive hook-up pliers **CN-HP**. Commercially available pliers cannot be used.

- Prior to using the sensor, affix the cable in a way as to avoid direct stress on the crimped part.

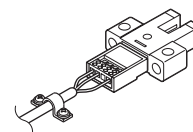

DIMENSIONS (Unit: mm in)

The CAD data in the dimensions can be downloaded from our website.

PM-K44 PM-K44P Sensor

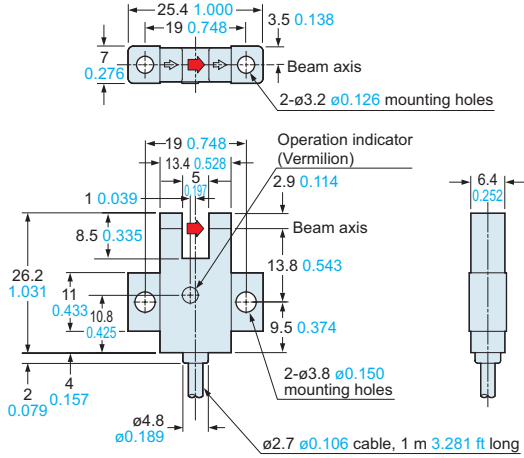

PM-T44 PM-T44P Sensor

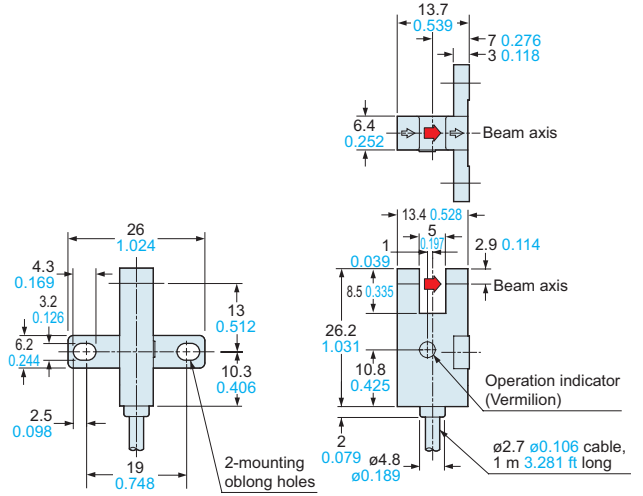

PM-L44 PM-L44P Sensor

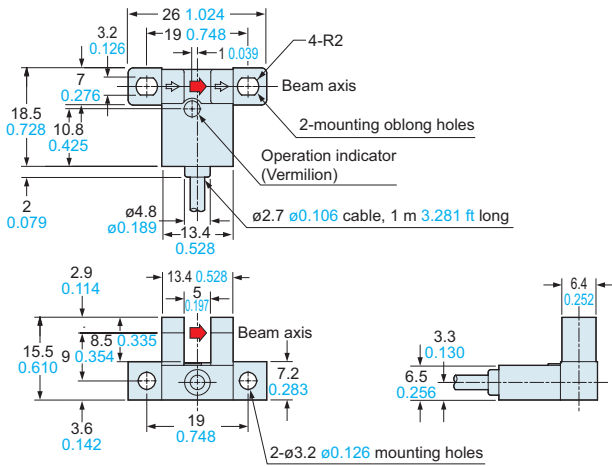

PM-Y44 PM-Y44P Sensor

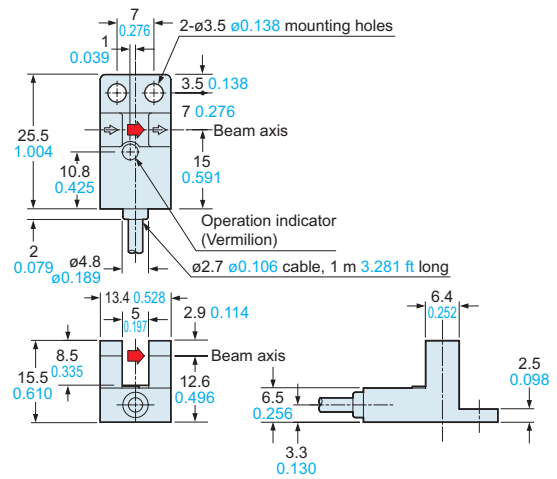

PM-F44 PM-F44P Sensor

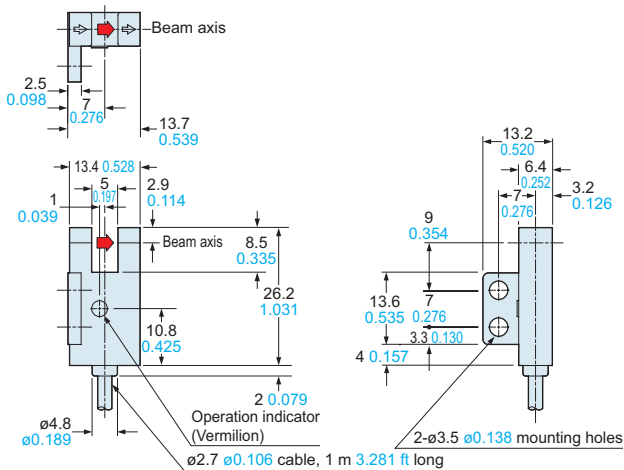

PM-R44 PM-R44P Sensor

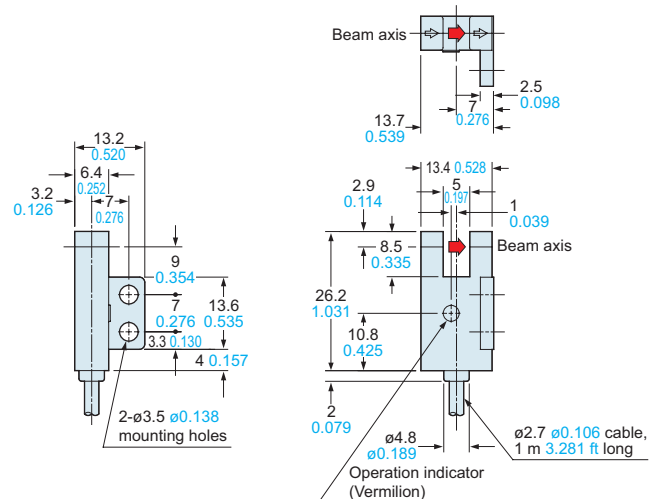

FIBER SENSORS

LASER SENSORS

PHOTO-ELECTRIC SENSORS

MICRO PHOTO-ELECTRIC SENSORS

AREA SENSORS

LIGHT CURTAINS / SAFETY COMPONENTS

PRESSURE / FLOW SENSORS

INDUCTIVE PROXIMITY SENSORS

PARTICULAR USE SENSORS

SENSOR OPTIONS

SMALL WIRE-SAVING UNITS

WIRE-SAVING SYSTEMS

MEASUREMENT SENSORS

STATIC ELECTRICITY PREVENTION DEVICES

LASER MARKERS

PLC

HUMAN MACHINE INTERFACES

ENERGY CONSUMPTION VISUALIZATION COMPONENTS

FA COMPONENTS

MACHINE VISION SYSTEMS

UV CURING SYSTEMS

Selection Guide

U-shaped

Convergent

Reflective

PM-64

PM-24

PM-44/ PM-54

DIMENSIONS (Unit: mm in)

The CAD data in the dimensions can be downloaded from our website.

- FIBER SENSORS
- LASER SENSORS
- PHOTO-ELECTRIC SENSORS
- MICRO PHOTO-ELECTRIC SENSORS
- AREA SENSORS
- LIGHT CURTAINS/ SAFETY COMPONENTS
- PRESSURE/ FLOW SENSORS
- INDUCTIVE PROXIMITY SENSORS
- PARTICULAR USE SENSORS
- SENSOR OPTIONS
- SIMPLE WIRE-SAVING UNITS
- WIRE-SAVING SYSTEMS
- MEASURE-MENT SENSORS
- STATIC ELECTRICITY PREVENTION DEVICES
- LASER MARKERS
- PLC
- HUMAN MACHINE INTERFACES
- ENERGY CONSUMPTION VISUALIZATION COMPONENTS
- FA COMPONENTS
- MACHINE VISION SYSTEMS
- UV CURING SYSTEMS

PM-K54 PM-K54P Sensor

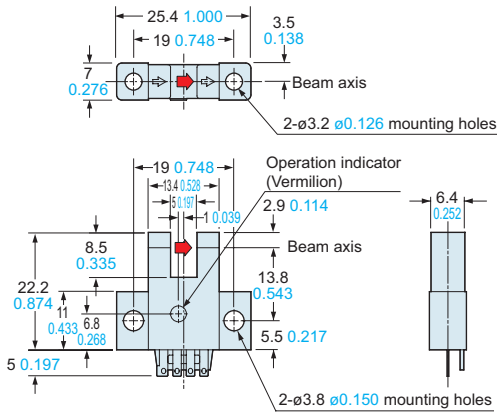

PM-T54 PM-T54P Sensor

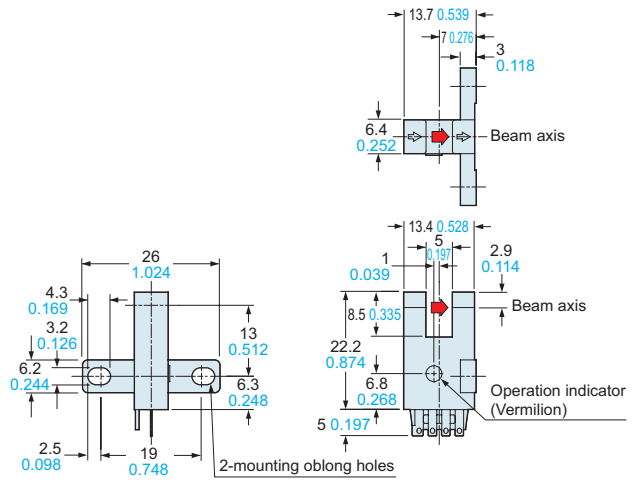

PM-L54 PM-L54P Sensor

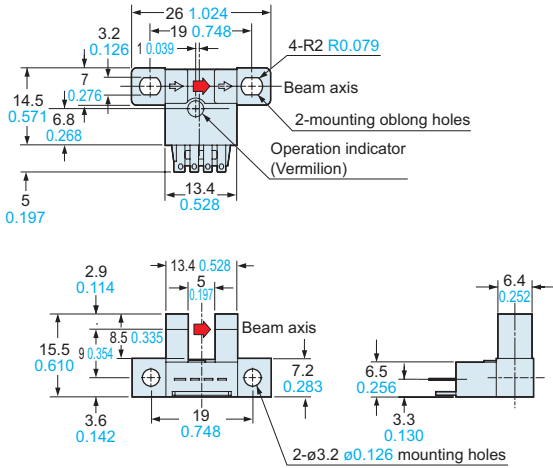

PM-Y54 PM-Y54P Sensor

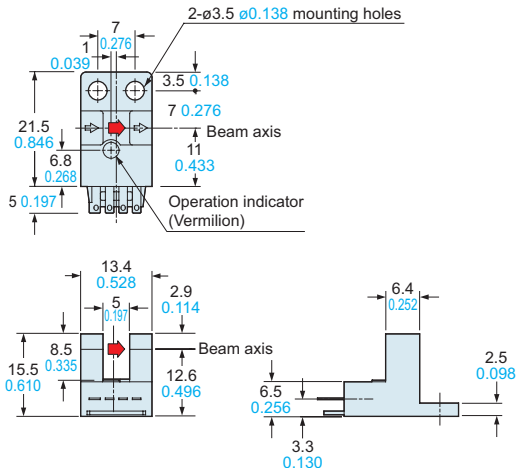

PM-F54 PM-F54P Sensor

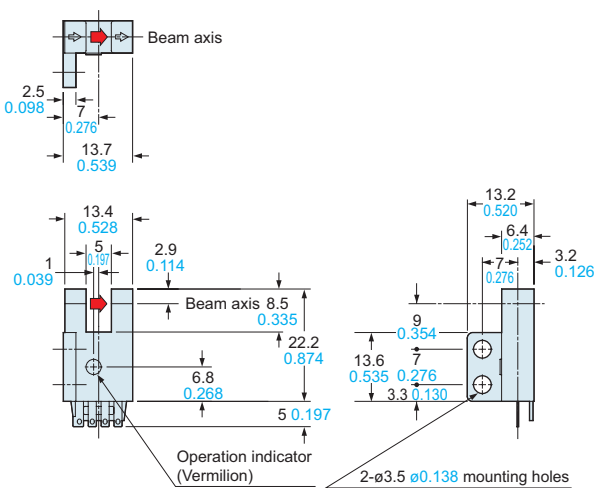

PM-R54 PM-R54P Sensor

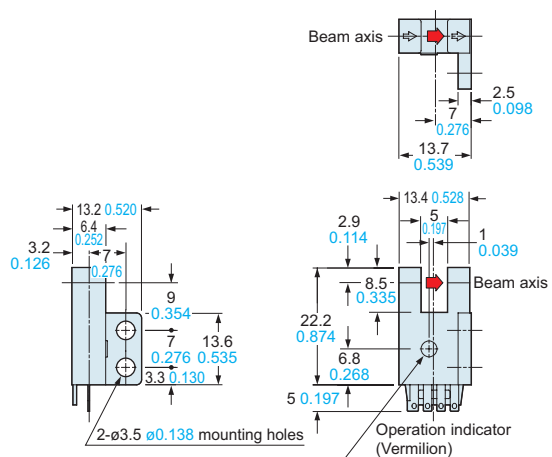

- Selection Guide
- U-shaped
- Convergent
- Reflective
- PM-64
- PM-24
- PM-44/ PM-54

DIMENSIONS (Unit: mm in)

The CAD data in the dimensions can be downloaded from our website.

*** Terminal part (PM-□54, PM-□54P)**

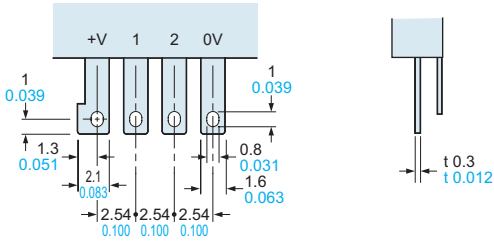

CN-14

Connector (Optional)

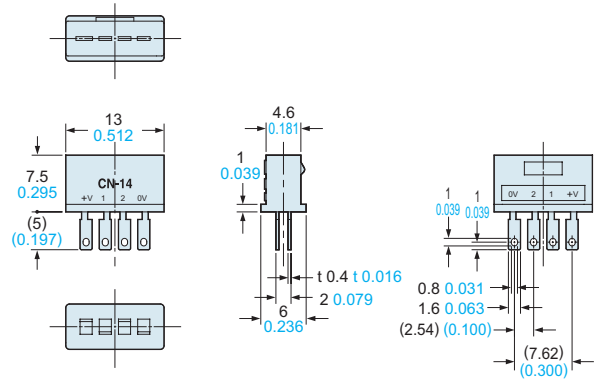

CN-14H CN-14H-2

Hook-up connector (Optional)

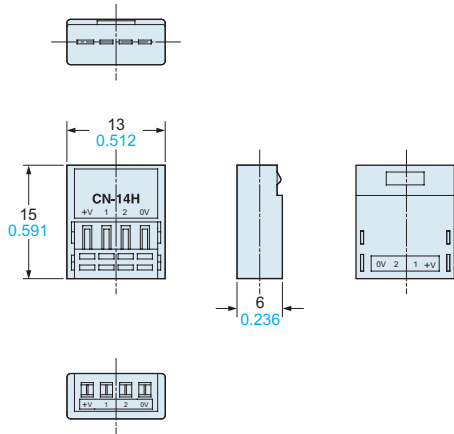

CN-14H-C1 CN-14H-C3

Connector attached cable (Optional)

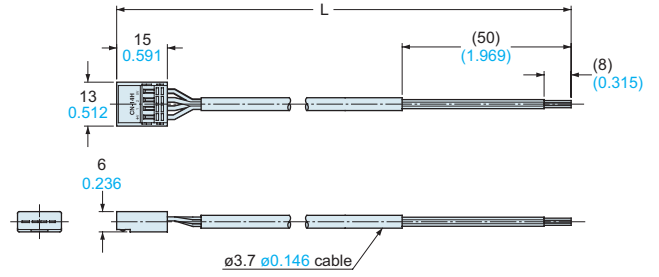

• Length L

Model No.	Length L
CN-14H-C1	1 m 3.281 ft
CN-14H-C3	3 m 9.843 ft

FIBER SENSORS

LASER SENSORS

PHOTO-ELECTRIC SENSORS

MICRO PHOTO-ELECTRIC SENSORS

AREA SENSORS

LIGHT CURTAINS / SAFETY COMPONENTS

PRESSURE / FLOW SENSORS

INDUCTIVE PROXIMITY SENSORS

PARTICULAR USE SENSORS

SENSOR OPTIONS

SIMPLE WIRE-SAVING UNITS

WIRE-SAVING SYSTEMS

MEASUREMENT SENSORS

STATIC ELECTRICITY PREVENTION DEVICES

LASER MARKERS

PLC

HUMAN MACHINE INTERFACES

ENERGY CONSUMPTION VISUALIZATION COMPONENTS

FA COMPONENTS

MACHINE VISION SYSTEMS

UV CURING SYSTEMS

Selection Guide

U-shaped

Convergent Reflective

PM-64

PM-24

PM-44/ PM-54