

# 74F564

## Octal D-Type Flip-Flop with 3-STATE Outputs

### General Description

The 74F564 is a high-speed, low power octal flip-flop with a buffered common Clock (CP) and a buffered common Output Enable ( $\overline{OE}$ ). The information presented to the D inputs is sorted in the flip-flops on the LOW-to-HIGH Clock (CP) transition.

This device is functionally identical to the 74F574, but has inverted outputs.

### Features

- Inputs and outputs on opposite sides of package allow easy interface with microprocessors
- Useful as input or output port for microprocessors
- Functionally identical to 74F574
- 3-STATE outputs for bus-oriented applications

### Ordering Code:

Order Number	Package Number	Package Description
74F564SJ	M20D	20-Lead Small Outline Package (SOP), EIAJ TYPE II, 5.3mm Wide
74F564PC	N20A	20-Lead Plastic Dual-In-Line Package (PDIP), JEDEC MS-001, 0.300 Wide

Devices also available in Tape and Reel. Specify by appending the suffix letter "X" to the ordering code.

### Logic Symbols

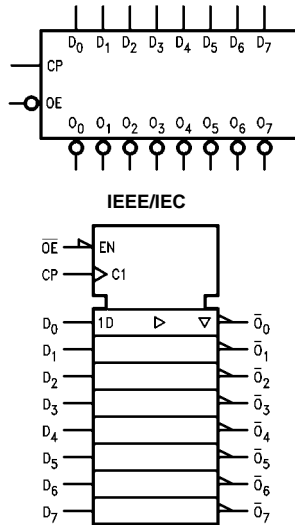

### Connection Diagram

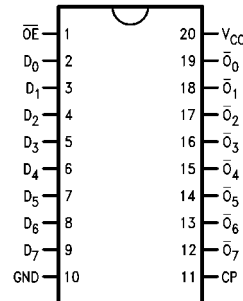

74F564 Octal D-Type Flip-Flop with 3-STATE Outputs

### Unit Loading/Fan Out

Pin Names	Description	U.L. HIGH/LOW	Input $I_{IH}/I_{IL}$ Output $I_{OH}/I_{OL}$
D <sub>0</sub> -D <sub>7</sub>	Data Inputs	1.0/1.0	20 $\mu$ A/-0.6 mA
CP	Clock Pulse Input (Active Rising Edge)	1.0/1.0	20 $\mu$ A/-0.6 mA
$\overline{OE}$	3-STATE Output Enable Input (Active LOW)	1.0/1.0	20 $\mu$ A/-0.6 mA
$\overline{O_0}$ - $\overline{O_7}$	3-STATE Outputs	150/40 (33.3)	-3 mA/24 mA (20 mA)

### Functional Description

The 74F564 consists of eight edge-triggered flip-flops with individual D-type inputs and 3-STATE true outputs. The buffered clock and buffered Output Enable are common to all flip-flops. The eight flip-flops will store the state of their individual D inputs that meet the setup and hold times requirements on the LOW-to-HIGH Clock (CP) transition. With the Output Enable ( $\overline{OE}$ ) LOW, the contents of the eight flip-flops are available at the outputs. When  $\overline{OE}$  is HIGH, the outputs go to the high impedance state. Operation of the  $\overline{OE}$  input does not affect the state of the flip-flops.

### Function Table

Inputs			Internal	Outputs	Function
$\overline{OE}$	CP	D	Q	O	
H	H	L	NC	Z	Hold
H	H	H	NC	Z	Hold
H	$\nearrow$	L	H	Z	Load
H	$\nearrow$	H	L	Z	Load
L	$\nearrow$	L	H	H	Data Available
L	$\nearrow$	H	L	L	Data Available
L	H	L	NC	NC	No Change in Data
L	H	H	NC	NC	No Change in Data

H = HIGH Voltage Level  
 L = LOW Voltage Level  
 X = Immaterial  
 Z = High Impedance  
 $\nearrow$  = LOW-to-HIGH Transition  
 NC = No Change

### Logic Diagram

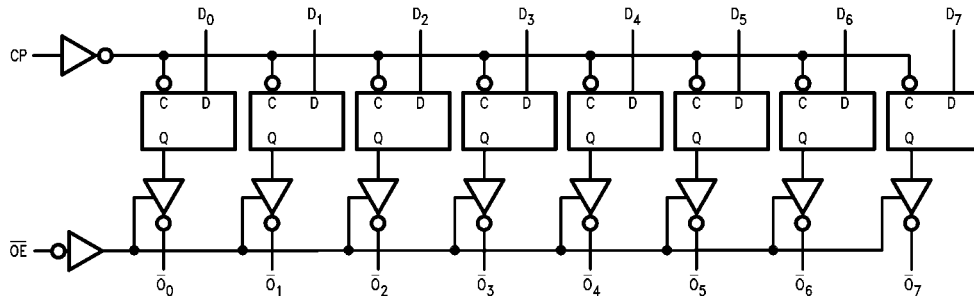

Please note that this diagram is provided only for the understanding of logic operations and should not be used to estimate propagation delays.

**Absolute Maximum Ratings**(Note 1)

Storage Temperature	-65°C to +150°C
Ambient Temperature under Bias	-55°C to +125°C
Junction Temperature under Bias	-55°C to +150°C
V <sub>CC</sub> Pin Potential to Ground Pin	-0.5V to +7.0V
Input Voltage (Note 2)	-0.5V to +7.0V
Input Current (Note 2)	-30 mA to +5.0 mA
Voltage Applied to Output in HIGH State (with V <sub>CC</sub> = 0V)	
Standard Output	-0.5V to V <sub>CC</sub>
3-STATE Output	-0.5V to +5.5V
Current Applied to Output in LOW State (Max)	twice the rated I <sub>OL</sub> (mA)

**Recommended Operating Conditions**

Free Air Ambient Temperature	0°C to +70°C
Supply Voltage	+4.5V to +5.5V

**Note 1:** Absolute maximum ratings are values beyond which the device may be damaged or have its useful life impaired. Functional operation under these conditions is not implied.

**Note 2:** Either voltage limit or current limit is sufficient to protect inputs.

**DC Electrical Characteristics**

Symbol	Parameter	Min	Typ	Max	Units	V <sub>CC</sub>	Conditions
V <sub>IH</sub>	Input HIGH Voltage	2.0			V		Recognized as a HIGH Signal
V <sub>IL</sub>	Input LOW Voltage			0.8	V		Recognized as a LOW Signal
V <sub>CD</sub>	Input Clamp Diode Voltage			-1.2	V	Min	I <sub>IN</sub> = -18 mA
V <sub>OH</sub>	Output HIGH Voltage	10% V <sub>CC</sub> 10% V <sub>CC</sub> 5% V <sub>CC</sub> 5% V <sub>CC</sub>	2.5 2.4 2.7 2.7		V	Min	I <sub>OH</sub> = -1 mA I <sub>OH</sub> = -3 mA I <sub>OH</sub> = -1 mA I <sub>OH</sub> = -3 mA
V <sub>OL</sub>	Output LOW Voltage	10% V <sub>CC</sub>		0.5	V	Min	I <sub>OL</sub> = 24 mA
I <sub>IH</sub>	Input HIGH Current			5.0	μA	Max	V <sub>IN</sub> = 2.7V
I <sub>BVI</sub>	Input HIGH Current Breakdown Test			7.0	μA	Max	V <sub>IN</sub> = 7.0V
I <sub>CEX</sub>	Output HIGH Leakage Current			50	μA	Max	V <sub>OUT</sub> = V <sub>CC</sub>
V <sub>ID</sub>	Input Leakage Test	4.75			V	0.0	I <sub>ID</sub> = 1.9 μA All Other Pins Grounded
I <sub>OD</sub>	Output Leakage Circuit Current			3.75	μA	0.0	V <sub>IOD</sub> = 150 mV All Other Pins Grounded
I <sub>IL</sub>	Input LOW Current			-0.6	mA	Max	V <sub>IN</sub> = 0.5V
I <sub>OZH</sub>	Output Leakage Current			50	μA	Max	V <sub>OUT</sub> = 2.7V
I <sub>OZL</sub>	Output Leakage Current			-50	μA	Max	V <sub>OUT</sub> = 0.5V
I <sub>OS</sub>	Output Short-Circuit Current	-60		-150	mA	Max	V <sub>OUT</sub> = 0V
I <sub>ZZ</sub>	Bus Drainage Test			500	μA	0.0V	V <sub>OUT</sub> = 5.25V
I <sub>CCZ</sub>	Power Supply Current		55	86	mA	Max	V <sub>O</sub> = HIGH Z

AC Electrical Characteristics							
Symbol	Parameter	T <sub>A</sub> = +25°C V <sub>CC</sub> = +5.0V C <sub>L</sub> = 50 pF			T <sub>A</sub> = 0°C to +70°C V <sub>CC</sub> = +5.0V C <sub>L</sub> = 50 pF		Units
		Min	Typ	Max	Min	Max	
f <sub>MAX</sub>	Maximum Clock Frequency	100			70		MHz
t <sub>PLH</sub>	Propagation Delay	2.5	5.2	8.5	2.5	8.5	ns
t <sub>PHL</sub>	CP to $\bar{O}_n$	2.5	5.9	8.5	2.5	8.5	
t <sub>PZH</sub>	Output Enable Time	3.0	5.6	9.0	2.5	10.0	ns
t <sub>PZL</sub>		3.0	6.2	9.0	2.5	10.0	
t <sub>PHZ</sub>	Output Disable Time	1.5	3.4	5.5	1.5	6.5	ns
t <sub>PLZ</sub>		1.5	2.7	5.5	1.5	6.5	
AC Operating Requirements							
Symbol	Parameter	T <sub>A</sub> = +25°C V <sub>CC</sub> = +5.0V		T <sub>A</sub> = 0°C to +70°C V <sub>CC</sub> = +5.0V		Units	
		Min	Max	Min	Max		
t <sub>S</sub> (H)	Setup Time, HIGH or LOW	2.0		2.0		ns	
t <sub>S</sub> (L)	D <sub>n</sub> to CP	2.5		2.5			
t <sub>H</sub> (H)	Hold Time, HIGH or LOW	2.0		2.0			
t <sub>H</sub> (L)	D <sub>n</sub> to CP	2.0		2.0			
t <sub>W</sub> (H)	CP Pulse Width	5.0		5.0		ns	
t <sub>W</sub> (L)	HIGH or LOW	5.0		5.0			

**Physical Dimensions** inches (millimeters) unless otherwise noted

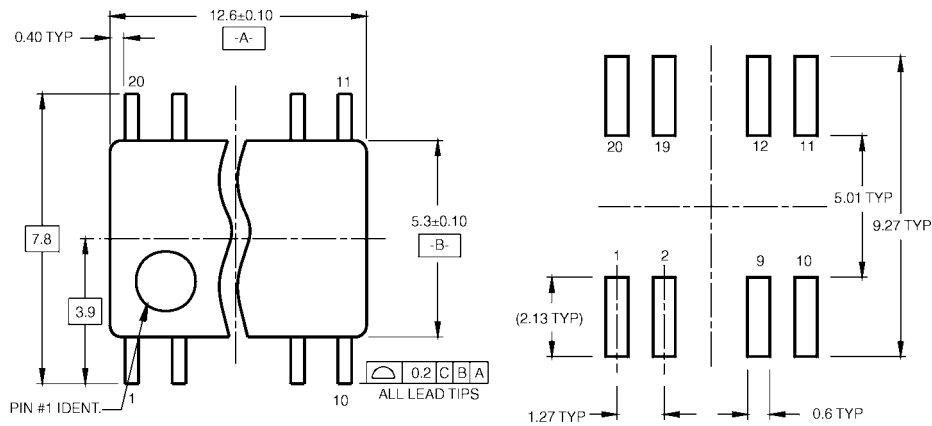

LAND PATTERN RECOMMENDATION

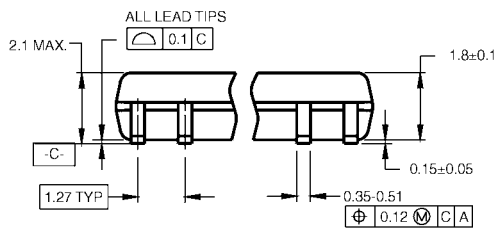

DIMENSIONS ARE IN MILLIMETERS

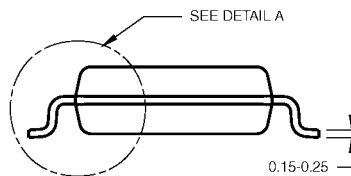

- NOTES:
- A. CONFORMS TO EIAJ EDR-7320 REGISTRATION, ESTABLISHED IN DECEMBER, 1998.
  - B. DIMENSIONS ARE IN MILLIMETERS.
  - C. DIMENSIONS ARE EXCLUSIVE OF BURRS, MOLD FLASH, AND TIE BAR EXTRUSIONS.

M20DRevB1

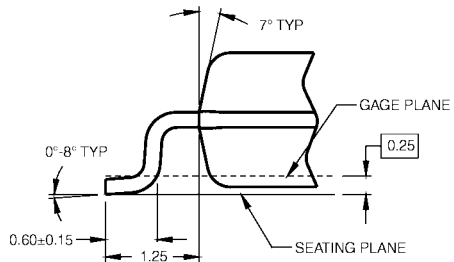

DETAIL A

**20-Lead Small Outline Package (SOP), EIAJ TYPE II, 5.3mm Wide  
Package Number M20D**

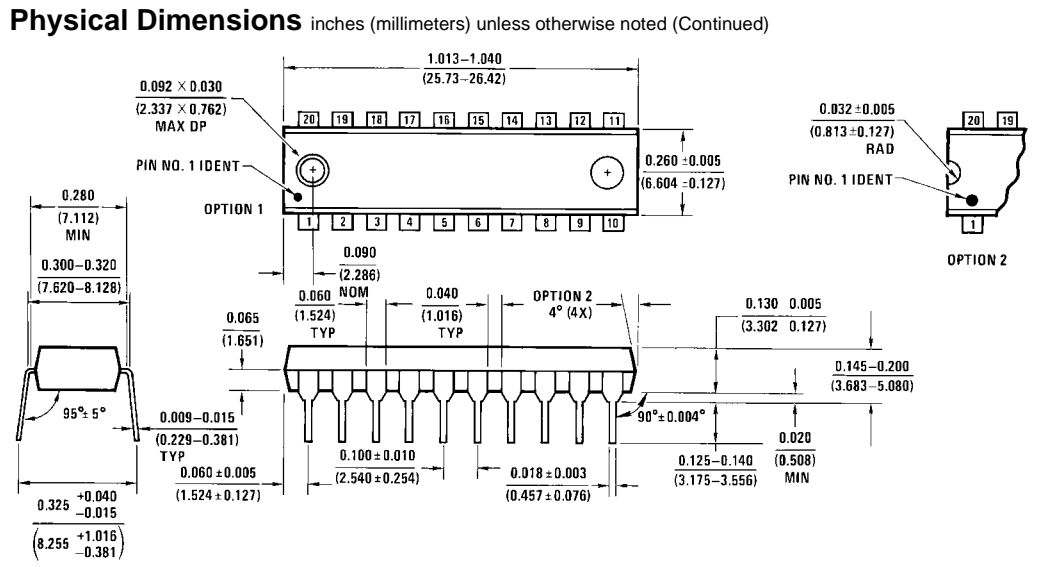

20-Lead Plastic Dual-In-Line Package (PDIP), JEDEC MS-001, 0.300 Wide Package Number N20A

Fairchild does not assume any responsibility for use of any circuitry described, no circuit patent licenses are implied and Fairchild reserves the right at any time without notice to change said circuitry and specifications.

**LIFE SUPPORT POLICY**

FAIRCHILD'S PRODUCTS ARE NOT AUTHORIZED FOR USE AS CRITICAL COMPONENTS IN LIFE SUPPORT DEVICES OR SYSTEMS WITHOUT THE EXPRESS WRITTEN APPROVAL OF THE PRESIDENT OF FAIRCHILD SEMICONDUCTOR CORPORATION. As used herein:

1. Life support devices or systems are devices or systems which, (a) are intended for surgical implant into the body, or (b) support or sustain life, and (c) whose failure to perform when properly used in accordance with instructions for use provided in the labeling, can be reasonably expected to result in a significant injury to the user.
2. A critical component in any component of a life support device or system whose failure to perform can be reasonably expected to cause the failure of the life support device or system, or to affect its safety or effectiveness.

[www.fairchildsemi.com](http://www.fairchildsemi.com)