



DMP4051LK3

40V P-CHANNEL ENHANCEMENT MODE MOSFET

Product Summary

$V_{(BR)DSS}$	$R_{DS(on)}$	I_D $T_A = 25^\circ C$
-40V	51mΩ @ $V_{GS} = -10V$	-10.5A
	85mΩ @ $V_{GS} = -4.5V$	-8.4A

Description and Applications

This MOSFET has been designed to minimize the on-state resistance ($R_{DS(on)}$) and yet maintain superior switching performance, making it ideal for high efficiency power management applications.

- Backlighting
- DC-DC Converters
- Power management functions

Features and Benefits

- 100% Unclamped Inductive Switch (UIS) test in production
- Low on-resistance
- Fast switching speed
- **“Green” component and RoHS compliant (Note 1)**
- **Qualified to AEC-Q101 Standards for High Reliability**

Mechanical Data

- Case: TO252
- Case Material: Molded Plastic, “Green” Molding Compound. UL Flammability Classification Rating 94V-0 (Note 1)
- Moisture Sensitivity: Level 1 per J-STD-020
- Terminals: Matte Tin Finish annealed over Copper leadframe. Solderable per MIL-STD-202, Method 208
- Weight: 0.33 grams (approximate)

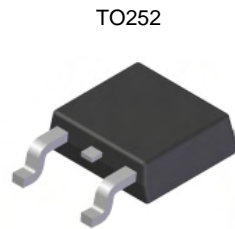

Top View

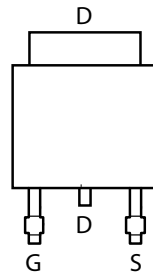

Top View
Pin-Out

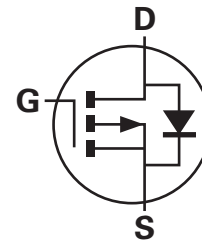

Equivalent Circuit

Ordering Information (Notes 1 & 2)

Product	Grade	Marking	Reel size (inches)	Tape width (mm)	Quantity per reel
DMP4051LK3-13	Commercial	P4051L	13	16	2,500
DMP4051LK3Q-13	Automotive	P4051L	13	16	2,500

- Notes:
1. Diodes, Inc. defines “Green” products as those which are RoHS compliant and contain no halogens or antimony compounds; further information about Diodes Inc.’s “Green” Policy can be found on our website. For packaging details, go to our website.
 2. Products with Q-suffix are automotive grade. Automotive products are electrical and thermal the same as the commercial, except where specified.

Marking Information

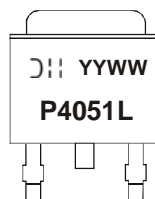

- ⌋⌋ = Manufacturer’s Marking
- P4051L = Product Type Marking Code
- YYWW = Date Code Marking
- YY = Year (ex: 09 = 2009)
- WW = Week (01 - 53)

Maximum Ratings @ $T_A = 25^\circ\text{C}$ unless otherwise specified

Characteristic			Symbol	Value	Unit
Drain-Source voltage			V_{DSS}	-40	V
Gate-Source voltage		(Note 3)	V_{GS}	± 20	V
Single Pulsed Avalanche Energy		(Note 9)	E_{AS}	50	mJ
Single Pulsed Avalanche Current		(Note 9)	I_{AS}	20.3	A
Continuous Drain current	$V_{GS} = 10\text{V}$	(Note 5)	I_D	-10.5	A
		$T_A = 70^\circ\text{C}$ (Note 5)		-8.40	
		(Note 4)		-7.2	
Pulsed Drain current	$V_{GS} = 10\text{V}$	(Note 6)	I_{DM}	-28.9	A
Continuous Source current (Body diode)		(Note 5)	I_S	-10.1	A
Pulsed Source current (Body diode)		(Note 5)	I_{SM}	-28.9	A

Thermal Characteristics @ $T_A = 25^\circ\text{C}$ unless otherwise specified

Characteristic		Symbol	Value	Unit
Power dissipation Linear derating factor	(Note 4)	P_D	4.18	W mW/ $^\circ\text{C}$
	(Note 5)		33.4	
	(Note 7)		8.9	
	(Note 7)		71.4	
Thermal Resistance, Junction to Ambient	(Note 4)	$R_{\theta JA}$	2.14	$^\circ\text{C/W}$
	(Note 5)		17.1	
	(Note 7)		29.9	
Thermal Resistance, Junction to Lead	(Note 8)	$R_{\theta JL}$	14.0	$^\circ\text{C/W}$
Operating and storage temperature range		T_J, T_{STG}	2.46	$^\circ\text{C}$
			-55 to 150	

- Notes:
- AEC-Q101 V_{GS} maximum is $\pm 16\text{V}$.
 - For a device surface mounted on 50mm x 50mm x 1.6mm FR4 PCB with high coverage of single sided 2oz copper, in still air conditions; the device is measured when operating in a steady-state condition.
 - Same as note 4, except the device is measured at $t \leq 10$ sec.
 - Same as note 4, except the device is pulsed with $D = 0.02$ and pulse width 300 μs . The pulse current is limited by the maximum junction temperature.
 - For a device surface mounted on 25mm x 25mm x 1.6mm FR4 PCB with high coverage of single sided 1oz copper, in still air conditions; the device is measured when operating in a steady-state condition.
 - Thermal resistance from junction to solder-point (at the end of the drain lead).
 - UIS in production with $L = 100\mu\text{H}$, $V_{DD} = -40\text{V}$.

Thermal Characteristics

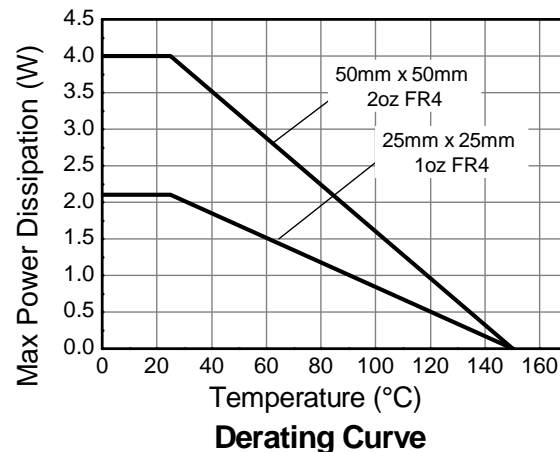
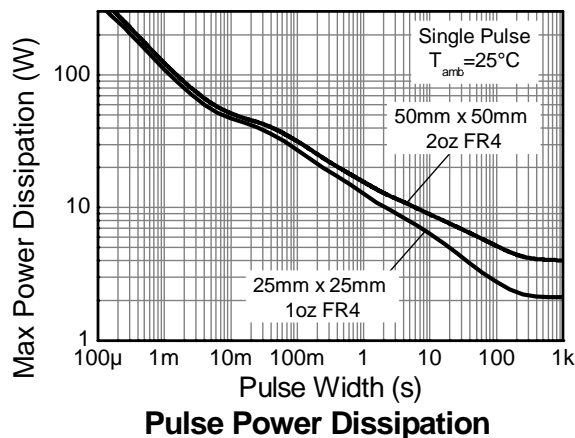
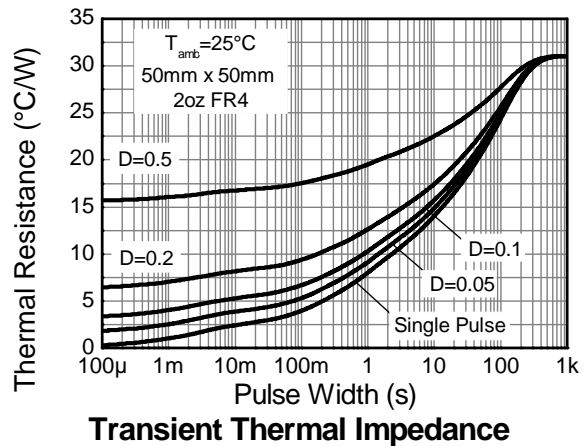
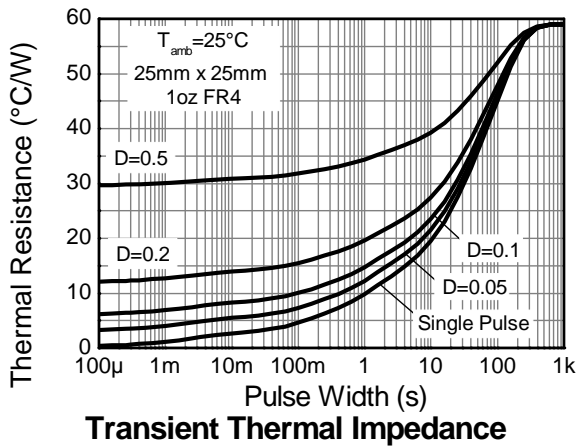
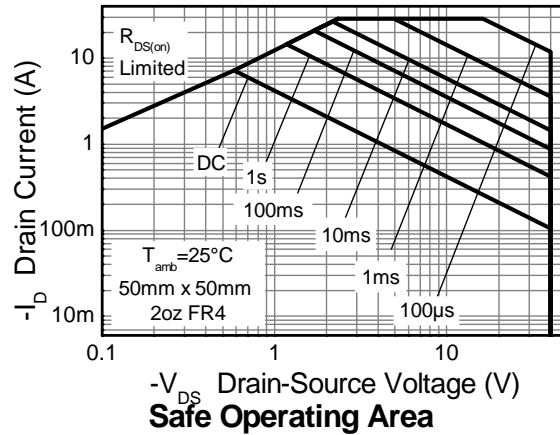
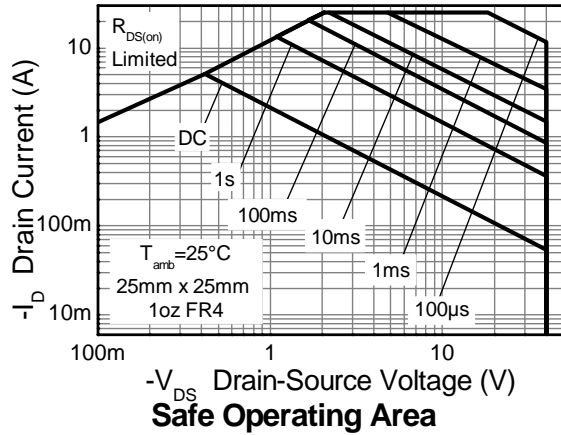

Electrical Characteristics @T_A = 25°C unless otherwise specified

Characteristic	Symbol	Min	Typ	Max	Unit	Test Condition
OFF CHARACTERISTICS						
Drain-Source Breakdown Voltage	BV _{DSS}	-40	—	—	V	I _D = -250μA, V _{GS} = 0V
Zero Gate Voltage Drain Current	I _{DSS}	—	—	-0.5	μA	V _{DS} = -40V, V _{GS} = 0V
Gate-Source Leakage	I _{GSS}	—	—	±100	nA	V _{GS} = ±20V, V _{DS} = 0V
ON CHARACTERISTICS						
Gate Threshold Voltage	V _{GS(th)}	-1.0	—	-3.0	V	I _D = -250μA, V _{DS} = V _{GS}
Static Drain-Source On-Resistance (Note 10)	R _{DS(on)}	—	0.041	0.051	Ω	V _{GS} = -10V, I _D = -12A
			0.059	0.085		V _{GS} = -4.5V, I _D = -8A
Forward Transconductance (Notes 10 & 11)	g _{fs}	—	16.6	—	S	V _{DS} = -15V, I _D = -12A
Diode Forward Voltage (Note 10)	V _{SD}	—	-0.98	-1.2	V	I _S = -12A, V _{GS} = 0V
Reverse recovery time (Note 11)	t _{rr}	—	138	—	ns	I _S = -12A, di/dt = 100A/μs
Reverse recovery charge (Note 11)	Q _{rr}	—	841	—	nC	
DYNAMIC CHARACTERISTICS (Note 11)						
Input Capacitance	C _{iss}	—	674	—	pF	V _{DS} = -20V, V _{GS} = 0V f = 1MHz
Output Capacitance	C _{oss}	—	115	—	pF	
Reverse Transfer Capacitance	C _{rss}	—	67.7	—	pF	V _{GS} = -10V I _D = -12A
Total Gate Charge (Note 12)	Q _g	—	7.0	—	nC	
Total Gate Charge (Note 12)	Q _g	—	14	—	nC	V _{GS} = -10V I _D = -12A
Gate-Source Charge (Note 12)	Q _{gs}	—	2.2	—	nC	
Gate-Drain Charge (Note 12)	Q _{gd}	—	3.7	—	nC	V _{DD} = -20V, V _{GS} = -10V I _D = -12A, R _G ≅ 6.0Ω
Turn-On Delay Time (Note 12)	t _{D(on)}	—	2.3	—	ns	
Turn-On Rise Time (Note 12)	t _r	—	14.1	—	ns	
Turn-Off Delay Time (Note 12)	t _{D(off)}	—	25.1	—	ns	
Turn-Off Fall Time (Note 12)	t _f	—	14.3	—	ns	

Notes: 10. Measured under pulsed conditions. Pulse width ≤ 300μs; duty cycle ≤ 2%
 11. For design aid only, not subject to production testing.
 12. Switching characteristics are independent of operating junction temperatures.

Typical Characteristics

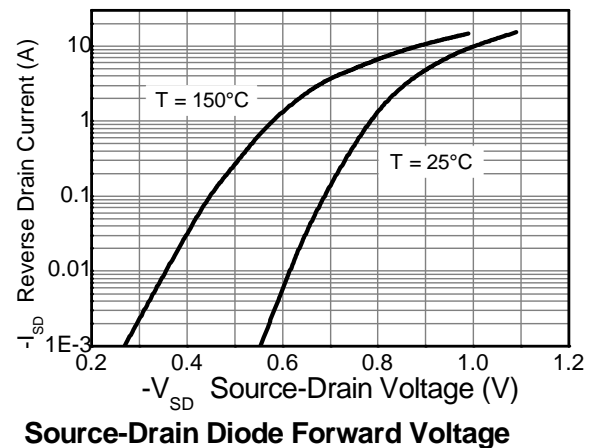
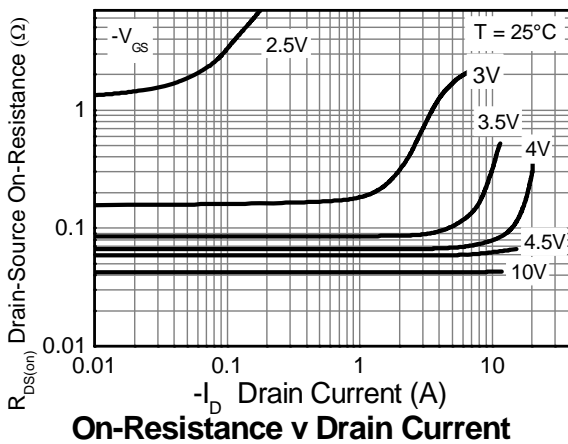
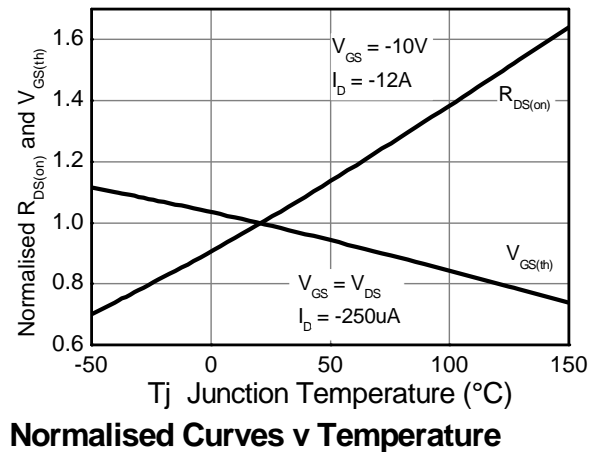
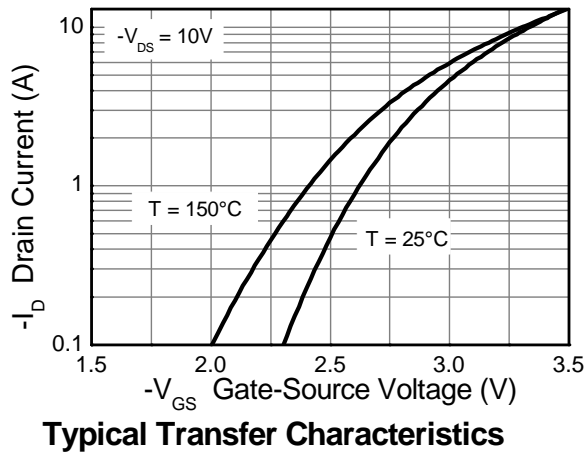
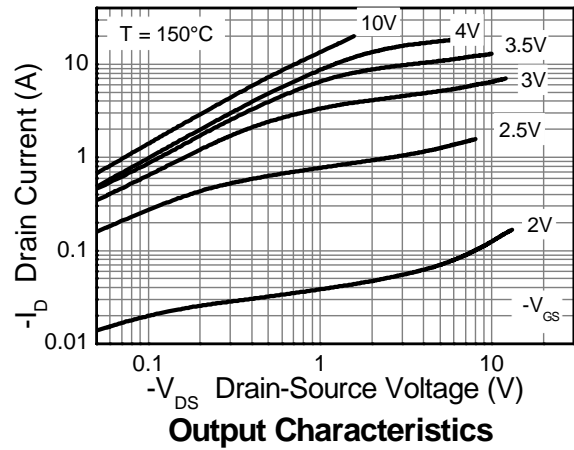
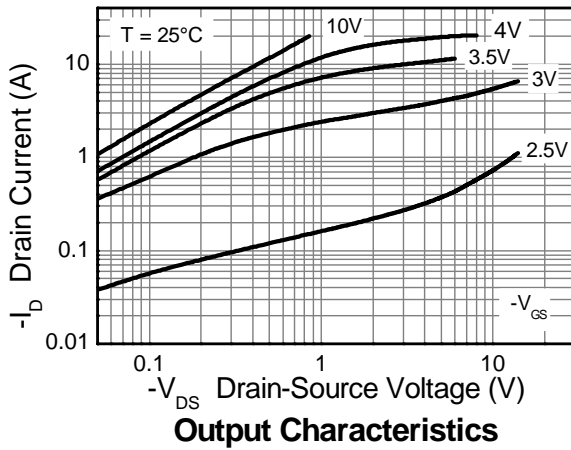

Typical Characteristics - continued

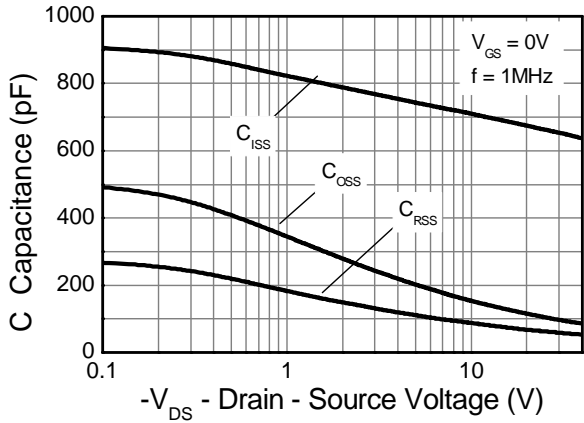

Capacitance v Drain-Source Voltage

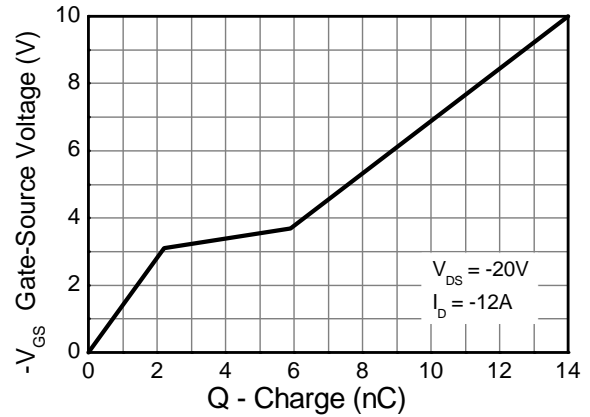

Gate-Source Voltage v Gate Charge

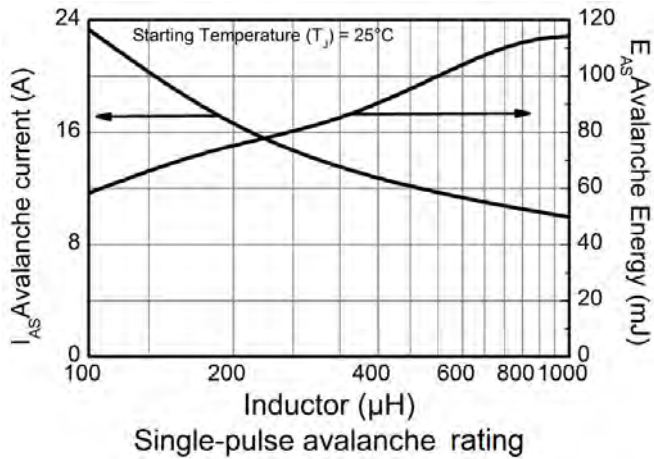

Single-pulse avalanche rating

Test Circuits

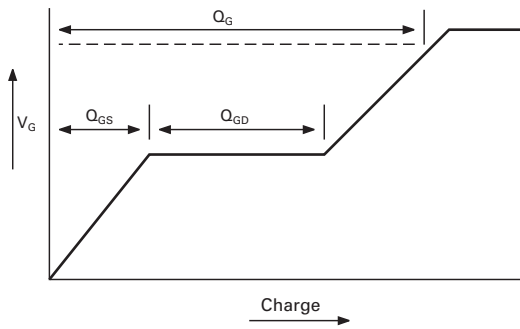

Basic gate charge waveform

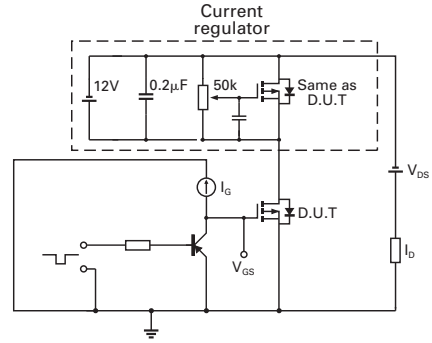

Gate charge test circuit

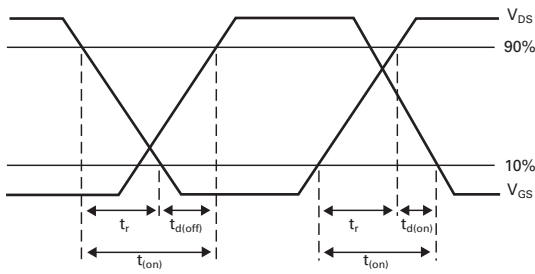

Switching time waveforms

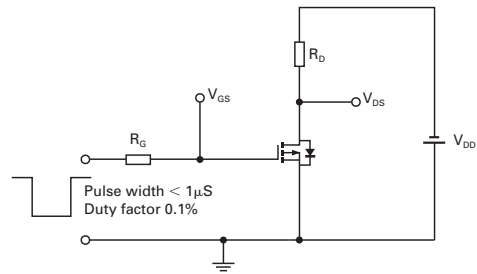

Switching time test circuit

DMP4051LK3

Package Outline Dimensions

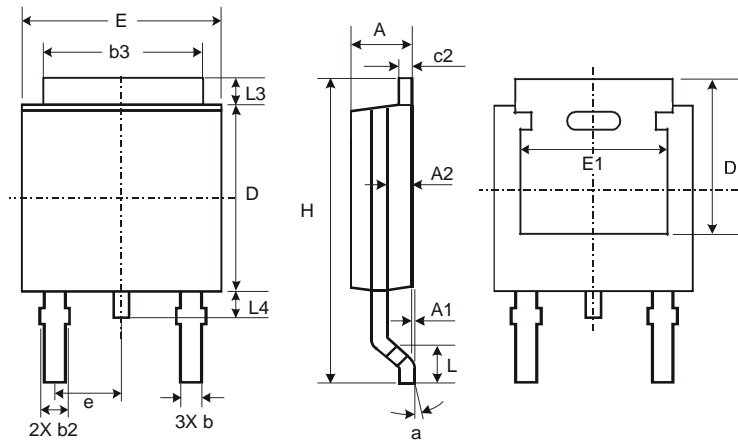

TO252			
Dim	Min	Max	Typ
A	2.19	2.39	2.29
A1	0.00	0.13	0.08
A2	0.97	1.17	1.07
b	0.64	0.88	0.783
b2	0.76	1.14	0.95
b3	5.21	5.46	5.33
c2	0.45	0.58	0.531
D	6.00	6.20	6.10
D1	5.21	-	-
e	-	-	2.286
E	6.45	6.70	6.58
E1	4.32	-	-
H	9.40	10.41	9.91
L	1.40	1.78	1.59
L3	0.88	1.27	1.08
L4	0.64	1.02	0.83
a	0°	10°	-
All Dimensions in mm			

Suggested Pad Layout

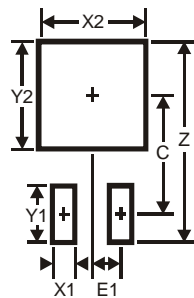

Dimensions	Value (in mm)
Z	11.6
X1	1.5
X2	7.0
Y1	2.5
Y2	7.0
C	6.9
E1	2.3

IMPORTANT NOTICE

DIODES INCORPORATED MAKES NO WARRANTY OF ANY KIND, EXPRESS OR IMPLIED, WITH REGARDS TO THIS DOCUMENT, INCLUDING, BUT NOT LIMITED TO, THE IMPLIED WARRANTIES OF MERCHANTABILITY AND FITNESS FOR A PARTICULAR PURPOSE (AND THEIR EQUIVALENTS UNDER THE LAWS OF ANY JURISDICTION).

Diodes Incorporated and its subsidiaries reserve the right to make modifications, enhancements, improvements, corrections or other changes without further notice to this document and any product described herein. Diodes Incorporated does not assume any liability arising out of the application or use of this document or any product described herein; neither does Diodes Incorporated convey any license under its patent or trademark rights, nor the rights of others. Any Customer or user of this document or products described herein in such applications shall assume all risks of such use and will agree to hold Diodes Incorporated and all the companies whose products are represented on Diodes Incorporated website, harmless against all damages.

Diodes Incorporated does not warrant or accept any liability whatsoever in respect of any products purchased through unauthorized sales channel. Should Customers purchase or use Diodes Incorporated products for any unintended or unauthorized application, Customers shall indemnify and hold Diodes Incorporated and its representatives harmless against all claims, damages, expenses, and attorney fees arising out of, directly or indirectly, any claim of personal injury or death associated with such unintended or unauthorized application.

Products described herein may be covered by one or more United States, international or foreign patents pending. Product names and markings noted herein may also be covered by one or more United States, international or foreign trademarks.

LIFE SUPPORT

Diodes Incorporated products are specifically not authorized for use as critical components in life support devices or systems without the express written approval of the Chief Executive Officer of Diodes Incorporated. As used herein:

A. Life support devices or systems are devices or systems which:

1. are intended to implant into the body, or
2. support or sustain life and whose failure to perform when properly used in accordance with instructions for use provided in the labeling can be reasonably expected to result in significant injury to the user.

B. A critical component is any component in a life support device or system whose failure to perform can be reasonably expected to cause the failure of the life support device or to affect its safety or effectiveness.

Customers represent that they have all necessary expertise in the safety and regulatory ramifications of their life support devices or systems, and acknowledge and agree that they are solely responsible for all legal, regulatory and safety-related requirements concerning their products and any use of Diodes Incorporated products in such safety-critical, life support devices or systems, notwithstanding any devices- or systems-related information or support that may be provided by Diodes Incorporated. Further, Customers must fully indemnify Diodes Incorporated and its representatives against any damages arising out of the use of Diodes Incorporated products in such safety-critical, life support devices or systems.

Copyright © 2012, Diodes Incorporated

www.diodes.com