

Features

- High resistance to heat and humidity
- Resistance to mechanical shock and pressure
- Accurate dimensions for automatic surface mounting
- Wide inductance range (1.0 nH to 1000 μ H)
- RoHS compliant*

CM45 Series SMT Chip Inductors

General Specifications

Temperature Rise	20 °C max.
Ambient Temperature	100 °C max.
Operating Temperature	-40 °C to +125 °C
Storage Temperature	-40 °C to +125 °C
Resistance to Soldering Heat	260 °C, 5 seconds

Materials

Core Material	Ferrite Core
Coil Type	Copper wire
Enclosure	Epoxy resin
Terminal	Sn

Product Dimensions

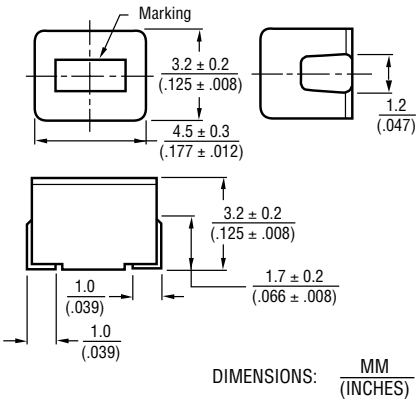

Recommended Land Pattern Dimensions

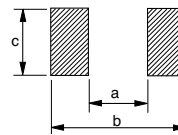

a	b	c
$\frac{2.0 \text{ to } 2.4}{(.079 \text{ to } .094)}$	$\frac{5.0 \text{ to } 5.3}{(.197 \text{ to } .209)}$	$\frac{1.4 \text{ to } 1.7}{(.055 \text{ to } .067)}$

Soldering Profile

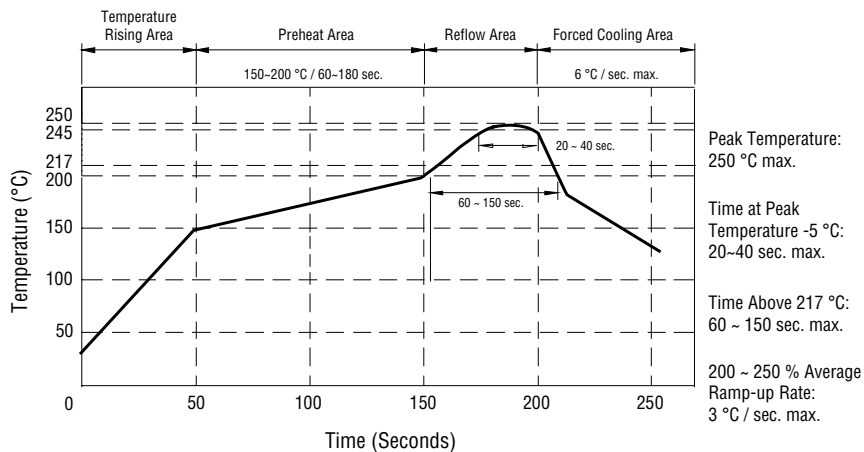

*RoHS Directive 2002/95/EC Jan. 27, 2003 including annex and RoHS Recast 2011/65/EU June 8, 2011.

Specifications are subject to change without notice.

The device characteristics and parameters in this data sheet can and do vary in different applications and actual device performance may vary over time. Users should verify actual device performance in their specific applications.

CM45 Series SMT Chip Inductors

BOURNS®

Packaging Specifications

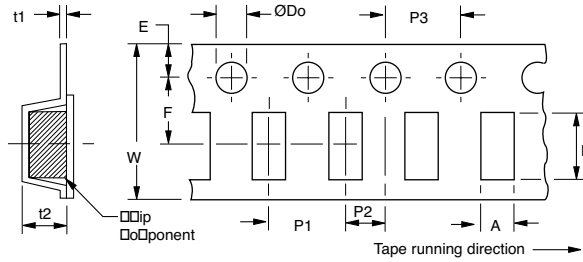

DIMENSIONS: $\frac{\text{MM}}{\text{(INCHES)}}$

Series	A	B	W	F	E	P1	P2	P3	D0 Dia.	D1 Dia.	t1	t2
CM45	3.60 (.142)	4.90 (.193)	12.00 (.472)	5.50 (.217)	1.75 (.069)	8.00 (.315)	2.00 (.079)	4.00 (.157)	1.50 (.059)	1.00 (.039)	0.25 (.010)	3.50 (.138)

Reel Dimensions

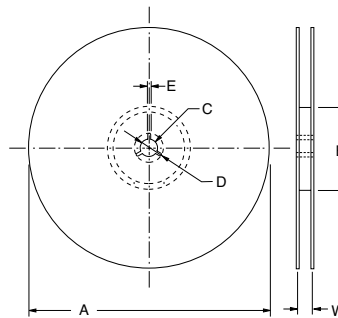

DIMENSIONS: $\frac{\text{MM}}{\text{(INCHES)}}$

A	B	C	D	E	W	Quantity	Weight
178 (7.008)	60 min.	13 (.512)	21 (.827)	2 (.079)	13 (.512)	500 pcs.	100 g

Specifications are subject to change without notice.
 The device characteristics and parameters in this data sheet can and do vary in different applications and actual device performance may vary over time.
 Users should verify actual device performance in their specific applications.

CM45 Series SMT Chip Inductors

BOURNS®

RoHS Compliant 1812 Size Part Number	Inductance μH	Std. Tolerance	Std. Tol. Code	1/2 Tolerance	1/2 Tol. Code	Q min.	Test Freq. MHz	SRF min. MHz	RDC ohm max	IDC mA max
CM453232-R10<1>L	0.10	±20 %	M	±10 %	K	35	25.2	300	0.18	800
CM453232-R12<1>L	0.12	±20 %	M	±10 %	K	35	25.2	280	0.2	770
CM453232-R15<1>L	0.15	±20 %	M	±10 %	K	35	25.2	250	0.22	730
CM453232-R18<1>L	0.18	±20 %	M	±10 %	K	35	25.2	220	0.24	700
CM453232-R22<1>L	0.22	±20 %	M	±10 %	K	40	25.2	200	0.25	665
CM453232-R27<1>L	0.27	±20 %	M	±10 %	K	40	25.2	180	0.26	635
CM453232-R33<1>L	0.33	±20 %	M	±10 %	K	40	25.2	165	0.28	605
CM453232-R39<1>L	0.39	±20 %	M	±10 %	K	40	25.2	150	0.30	575
CM453232-R47<1>L	0.47	±20 %	M	±10 %	K	40	25.2	145	0.32	545
CM453232-R56<1>L	0.56	±20 %	M	±10 %	K	40	25.2	140	0.36	520
CM453232-R68<1>L	0.68	±20 %	M	±10 %	K	40	25.2	135	0.40	500
CM453232-R82<1>L	0.82	±20 %	M	±10 %	K	40	25.2	130	0.45	475
CM453232-1R0<1>L	1.0	±10 %	K	±5 %	J	50	7.96	100	0.50	450
CM453232-1R2<1>L	1.2	±10 %	K	±5 %	J	50	7.96	80	0.55	430
CM453232-1R5<1>L	1.5	±10 %	K	±5 %	J	50	7.96	70	0.60	410
CM453232-1R8<1>L	1.8	±10 %	K	±5 %	J	50	7.96	60	0.65	390
CM453232-2R2<1>L	2.2	±10 %	K	±5 %	J	50	7.96	55	0.70	380
CM453232-2R7<1>L	2.7	±10 %	K	±5 %	J	50	7.96	50	0.75	370
CM453232-3R3<1>L	3.3	±10 %	K	±5 %	J	50	7.96	45	0.80	355
CM453232-3R9<1>L	3.9	±10 %	K	±5 %	J	50	7.96	40	0.90	330
CM453232-4R7<1>L	4.7	±10 %	K	±5 %	J	50	7.96	35	1.00	315
CM453232-5R6<1>L	5.6	±10 %	K	±5 %	J	50	7.96	33	1.10	300
CM453232-6R8<1>L	6.8	±10 %	K	±5 %	J	50	7.96	27	1.2	285
CM453232-8R2<1>L	8.2	±10 %	K	±5 %	J	50	7.96	25	1.4	270
CM453232-100<1>L	10	±10 %	K	±5 %	J	50	2.52	20	1.6	250
CM453232-120<1>L	12	±10 %	K	±5 %	J	50	2.52	18	2	225
CM453232-150<1>L	15	±10 %	K	±5 %	J	50	2.52	17	2.5	200
CM453232-180<1>L	18	±10 %	K	±5 %	J	50	2.52	15	2.8	190
CM453232-220<1>L	22	±10 %	K	±5 %	J	50	2.52	13	3.2	180
CM453232-270<1>L	27	±10 %	K	±5 %	J	50	2.52	12	3.6	170
CM453232-330<1>L	33	±10 %	K	±5 %	J	50	2.52	11	4	160
CM453232-390<1>L	39	±10 %	K	±5 %	J	50	2.52	10	4.5	150
CM453232-470<1>L	47	±10 %	K	±5 %	J	50	2.52	10	5	140
CM453232-560<1>L	56	±10 %	K	±5 %	J	50	2.52	9	5.5	135
CM453232-680<1>L	68	±10 %	K	±5 %	J	50	2.52	9	6	130
CM453232-820<1>L	82	±10 %	K	±5 %	J	50	2.52	8	7	120
CM453232-101<1>L	100	±10 %	K	±5 %	J	40	2.52	8	8	110
CM453232-121<1>L	120	±10 %	K	±5 %	J	40	0.796	6	8	110
CM453232-151<1>L	150	±10 %	K	±5 %	J	40	0.796	5	9	105
CM453232-181<1>L	180	±10 %	K	±5 %	J	40	0.796	5	9.5	102
CM453232-221<1>L	220	±10 %	K	±5 %	J	40	0.796	4	10	100
CM453232-271<1>L	270	±10 %	K	±5 %	J	40	0.796	4	12	92
CM453232-331<1>L	330	±10 %	K	±5 %	J	40	0.796	3.5	14	85
CM453232-391<1>L	390	±10 %	K	±5 %	J	40	0.796	3	18	80
CM453232-471<1>L	470	±10 %	K	±5 %	J	40	0.796	3	26	62
CM453232-561<1>L	560	±10 %	K	±5 %	J	30	0.796	3	30	50
CM453232-681<1>L	680	±10 %	K	±5 %	J	30	0.796	3	30	50
CM453232-821<1>L	820	±10 %	K	±5 %	J	30	0.796	2.5	35	30
CM453232-102<1>L	1000	±10 %	K	±5 %	J	30	0.252	2.5	40	30

<1> Enter tolerance code from standard or 1/2 tolerance column. Example: CM453232-1R2KL is standard tolerance; CM453232-1R2JL is 1/2 tolerance.

REV. 02/17

Specifications are subject to change without notice.

The device characteristics and parameters in this data sheet can and do vary in different applications and actual device performance may vary over time. Users should verify actual device performance in their specific applications.