

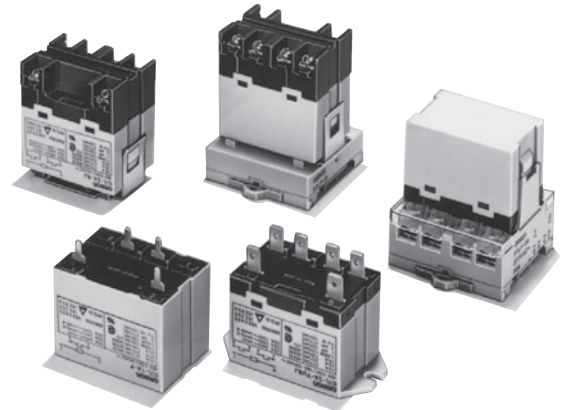

A High-capacity, High-dielectric-strength Relay Compatible with Momentary Voltage Drops

- No contact chattering for momentary voltage drops up to 50% of rated voltage.
- Wide-range AC-activated coil that handles 100 to 120 or 200 to 240 VAC at either 50 or 60 Hz.
- Miniature size for maximum switching power, particularly for inductive loads.
- Flame-resistance materials (UL94V-0-qualifying) used for all insulation material.
- Quick-connect, screw, and PCB terminals, and DIN track mounting available.
- Conforms to UL, CSA, TUV and meets IEC950.
- Safety design with contact gap of 3 mm.



G
7
L

RoHS Compliant

Model Number Legend

G7L-□□-□□□
1 2 3 4 5

- | | | |
|--|---|---|
| 1. Number of Poles 1: 1 pole 2: 2 poles | 3. Terminal Shape T: Quick connect terminals (#250) B: Screw terminals P: PCB terminals | 4. Mounting Construction Blank: E-bracket UB : Upper bracket |
| 2. Contact Form A: □PST-NO | 5. Special Functions J : With test button | |

Model Configuration

| Terminal | | Quick-connect terminals | Screw terminals | PCB terminals | |
|--|------------------|-------------------------|-----------------|---------------|----------|
| Classification | | Contact form | | | |
| E-bracket mounting (E-bracket is sold separately) | – | SPST-NO | G7L-1A-T | G7L-1A-B | – |
| | – | DPST-NO | G7L-2A-T | G7L-2A-B | – |
| | With test button | SPST-NO | G7L-1A-TJ | G7L-1A-BJ | – |
| | | DPST-NO | G7L-2A-TJ | G7L-2A-BJ | – |
| Upper bracket mounting | – | SPST-NO | G7L-1A-TUB | G7L-1A-BUB | – |
| | – | DPST-NO | G7L-2A-TUB | G7L-2A-BUB | – |
| | With test button | SPST-NO | G7L-1A-TUBJ | G7L-1A-BUBJ | – |
| | | DPST-NO | G7L-2A-TUBJ | G7L-2A-BUBJ | – |
| PCB mounting | – | SPST-NO | – | – | G7L-1A-P |
| | – | DPST-NO | – | – | G7L-2A-P |

Application Examples

- Compressors for air conditioners and heater switching controllers.
- Switching controllers for power tools or motors.
- Power controllers for water heaters.
- Power controllers for dryers.
- Lamp controls, motor drivers, and power supply switching in copy machines, facsimile machines, and other office equipment.
- Lighting controllers.
- Power controllers for packers or food processing equipment.
- Magnetron control in microwaves.
- Power controllers for Uninterruptible Power Supply (UPS)

List of E-bracket Mounting Models

| Mounting | | | | E-brackets | DIN Track Mounting Adapter | Front-connecting Socket |
|-------------------------|--------------|-----------|------------------|------------|----------------------------|-------------------------|
| Terminal | Contact form | Model | Test button | | | |
| Quick-connect terminals | SPST-NO | G7L-1A-T | – | ○ | ○ | ○ |
| | | G7L-1A-TJ | With test button | ○ | ○ | ○ |
| | DPST-NO | G7L-2A-T | – | ○ | ○ | ○ |
| | | G7L-2A-TJ | With test button | ○ | ○ | ○ |
| Screw terminals | SPST-NO | G7L-1A-B | – | ○ | ○ | – |
| | | G7L-1A-BJ | With test button | ○ | ○ | – |
| | DPST-NO | G7L-2A-B | – | ○ | ○ | – |
| | | G7L-2A-BJ | With test button | ○ | ○ | – |

Note. E-bracket (R99-07), adaptor (P7LF-D), surface connection socket (P7LF-06) are sold separately.

Ordering Information

E-bracket/Adapter/Socket Mounting

Quick-connect Terminal

| Number of poles | Model | Rated coil voltage | Minimum packing unit |
|-----------------|-----------------|----------------------------------|----------------------|
| 1 pole | G7L-1A-T | AC: 12, 24, 100/120, 200/240 | 20 pcs./tray |
| | | DC: 6, 12, 24, 48, 100 | |
| 2 poles | G7L-2A-T | AC: 12, 24, 50, 100/120, 200/240 | |
| | | DC: 6, 12, 24, 48, 100 | |

Upper Bracket Mounting

Quick-connect Terminal

| Number of poles | Model | Rated coil voltage | Minimum packing unit |
|-----------------|-------------------|----------------------------------|----------------------|
| 1 pole | G7L-1A-TUB | AC: 12, 24, 100/120, 200/240 | 20 pcs./tray |
| | | DC: 6, 12, 24, 48, 100 | |
| 2 poles | G7L-2A-TUB | AC: 12, 24, 50, 100/120, 200/240 | |
| | | DC: 6, 12, 24, 48, 100 | |

E-bracket/Adapter Mounting

Screw Terminal

| Number of poles | Model | Rated coil voltage | Minimum packing unit |
|-----------------|-----------------|------------------------------|----------------------|
| 1 pole | G7L-1A-B | AC: 12, 24, 100/120, 200/240 | 20 pcs./tray |
| | | DC: 6, 12, 24, 48, 100 | |
| 2 poles | G7L-2A-B | AC: 12, 24, 100/120, 200/240 | |
| | | DC: 12, 24, 48, 100 | |

Upper Bracket Mounting

Screw Terminal

| Number of poles | Model | Rated coil voltage | Minimum packing unit |
|-----------------|-------------------|----------------------------------|----------------------|
| 1 pole | G7L-1A-BUB | AC: 24, 100/120, 200/240 | 20 pcs./tray |
| | | DC: 6, 12, 24, 48, 100 | |
| 2 poles | G7L-2A-BUB | AC: 12, 24, 50, 100/120, 200/240 | |
| | | DC: 6, 12, 24, 48, 100 | |

PCB Mounting

| Number of poles | Model | Rated coil voltage | Minimum packing unit |
|-----------------|-----------------|--------------------------|----------------------|
| 1 pole | G7L-1A-P | AC: 100/120, 200/240 | 20 pcs./tray |
| | | DC: 12, 24, 48, 100 | |
| 2 poles | G7L-2A-P | AC: 24, 100/120, 200/240 | |
| | | DC: 6, 12, 24, 48, 100 | |

DIN Track Mounting Accessories

| Applicable products | Name | Model | Minimum packing unit |
|-----------------------------------|-----------|------------------|----------------------|
| Adaptor Surface Connection Socket | DIN Track | PPF-100N | 10 pcs. |
| | | PPF-50N | |
| | | PPF-100N2 | |
| | End plate | PPF-M | |
| | Spacer | PPF-S | |

Note. Order the models above in increments of the minimum quantity packaged.

E-bracket/Adapter/Socket Mounting (with test button)

Quick-connect Terminal

| Number of poles | Model | Rated coil voltage | Minimum packing unit |
|-----------------|------------------|--------------------------|----------------------|
| 1 pole | G7L-1A-TJ | AC: 24, 100/120, 200/240 | 20 pcs./tray |
| | | DC: 12, 24, 48, 100 | |
| 2 poles | G7L-2A-TJ | AC: 24, 100/120, 200/240 | |
| | | DC: 6, 12, 24, 48, 100 | |

Upper Bracket Mounting (with test button)

Quick-connect Terminal

| Number of poles | Model | Rated coil voltage | Minimum packing unit |
|-----------------|--------------------|----------------------------------|----------------------|
| 1 pole | G7L-1A-TUBJ | AC: 24, 100/120, 200/240 | 20 pcs./tray |
| | | DC: 6, 12, 24, 48, 100 | |
| 2 poles | G7L-2A-TUBJ | AC: 12, 24, 50, 100/120, 200/240 | |
| | | DC: 6, 12, 24, 48, 100 | |

E-bracket/Adapter Mounting (with test button)

Screw Terminal

| Number of poles | Model | Rated coil voltage | Minimum packing unit |
|-----------------|------------------|------------------------------|----------------------|
| 1 pole | G7L-1A-BJ | AC: 12, 24, 100/120, 200/240 | 20 pcs./tray |
| | | DC: 12, 24 | |
| 2 poles | G7L-2A-BJ | AC: 24, 100/120, 200/240 | |
| | | DC: 12, 24, 48, 100 | |

Upper Bracket Mounting (with test button)

Screw Terminal

| Number of poles | Model | Rated coil voltage | Minimum packing unit |
|-----------------|--------------------|--------------------------|----------------------|
| 1 pole | G7L-1A-BUBJ | AC: 24, 100/120, 200/240 | 20 pcs./tray |
| | | DC: 6, 12, 24, 48 | |
| 2 poles | G7L-2A-BUBJ | AC: 24, 100/120, 200/240 | |
| | | DC: 6, 12, 24, 48, 100 | |

Note 1. Please add the coil rated voltage (V) to the model number when ordering.

Example: G7L-1A-T AC12

In addition, the delivered product and its package will be marked with voltage specification as "□□ VDC".

Note 2. Refer to the precautions on **PCB Relays** provided in **General**

Information of the Relay Product Data Book, and "w-□-3" for coil characteristics of AC operation.

E-bracket/Adaptor/Socket/Cover

| Applicable Relay models | Name | Model | Minimum packing unit |
|--|-------------------------|----------------|----------------------|
| G7L-1A-T G7L-1A-TJ G7L-1A-B G7L-1A-BJ G7L-2A-T G7L-2A-TJ G7L-2A-B G7L-2A-BJ | E-bracket | R99-07 | 10 pcs. |
| G7L-1A-T G7L-1A-TJ G7L-2A-T G7L-2A-TJ | Adapter | P7LF-D | 1 pcs. |
| G7L-1A-T G7L-1A-TJ G7L-2A-T G7L-2A-TJ | Front-connecting Socket | P7LF-06 | 1 pcs. |
| G7L-1A-B G7L-1A-BJ G7L-1A-BUB G7L-1A-BUBJ G7L-2A-B G7L-2A-BJ G7L-2A-BUB G7L-2A-BUBJ | Cover | P7LF-C | 1 pcs. |

Note. Order the models above in increments of the minimum quantity packaged.

■ Ratings

Coil

| Item | Rated current (mA) | Coil resistance (Ω) | Coil inductance (H) | | Must operate voltage | Must release voltage | Max. permissible voltage | Power consumption (VA-W) |
|----------------|--------------------|---------------------|-------------------------------|--------------|----------------------|----------------------|--------------------------|--------------------------|
| | | | Armature ON | Armature OFF | | | | |
| Rated voltage | | | On the basis of rated voltage | | | | | |
| 12 VAC | 142 | / | / | / | 75% max. | 15% min. | 110% | Approx. 1.7 to 2.5 |
| 24 VAC | 71 | | | | | | | |
| 50 VAC | 34 | | | | | | | |
| 100 to 120 VAC | 17.0 to 20.4 | | | | | | | |
| 200 to 240 VAC | 8.5 to 10.2 | | | | | | | |
| 6 VDC | 317 | 18.9 | 0.09 | 0.21 | 75% max. | 15% min. | 110% | Approx. 1.9 |
| 12 VDC | 158 | 75 | 0.37 | 0.88 | | | | |
| 24 VDC | 79 | 303 | 1.42 | 3.54 | | | | |
| 48 VDC | 40 | 1220 | 6.1 | 15.3 | | | | |
| 100 VDC | 19 | 5260 | 21.3 | 60.0 | | | | |

- Note 1. The rated current and coil resistance are measured at a coil temperature of 23°C with tolerances of +15%/-20% for AC rated current and ±15% for DC coil resistance.
 2. The inductances shown above are reference values.
 3. Performance characteristic data are measured at a coil temperature of 23°C.
 4. The maximum allowable coil voltage refers to the maximum value in a varying range of operating power voltage, measured at ambient temperature 23°C.
 5. The "to" (for example "100 to 120") represents the range of rated voltages.

Contacts

| Item | Contact Form load | G7L-1A-T□ G7L-1A-B□ | | G7L-2A-T□ G7L-2A-B□ | | G7L-1A-P G7L-2A-P | |
|------------------------|-------------------|------------------------|-----------------------------|------------------------|-----------------------------|----------------------|-----------------------------|
| | | Resistive load | Inductive load (cosφ = 0.4) | Resistive load | Inductive load (cosφ = 0.4) | Resistive load | Inductive load (cosφ = 0.4) |
| Contact type | Double break | | | | | | |
| Contact material | Ag alloy | | | | | | |
| Rated load | 30 A at 220 VAC | 25 A at 220 VAC | 25 A at 220 VAC | | 20 A at 220 VAC | | |
| Rated carry current | 30 A | | 25 A | | 20 A | | |
| Max. switching voltage | 250 VAC | | | | | | |
| Max. switching current | 30 A | | 25 A | | 20 A | | |

Note. When using B-series (screw) products, since the screw diameter of the contact terminal is M4, be careful that the contact current should be 20 A or less according to JET standard (electrical appliance and material control law of Japan).

■ Characteristics

| | | |
|--|---|---|
| Contact resistance *1 | 50 mΩ max. | |
| Operate time *2 | 30 ms max. | |
| Release time *3 | 30 ms max. | |
| Max. operating frequency | Mechanical | 1,800 operations/hr |
| | Rated load | 1,800 operations/hr |
| Insulation resistance *3 | 100 MΩ min | |
| Dielectric strength | Between coil and contacts | 4,000 VAC min., 50/60 Hz for 1 min |
| | Between contacts of same polarity | 2,000 VAC, 50/60 Hz for 1 min |
| Between contacts of different polarity (DPST-NO model) | | |
| Impulse withstand voltage | 10,000 V between coil and contact *4 | |
| Vibration resistance | Destruction | 10 to 55 to 10 Hz, 0.75 mm single amplitude (1.5 mm double amplitude) |
| | Malfunction | 10 to 55 to 10 Hz, 0.75 mm single amplitude (1.5 mm double amplitude) |
| Shock resistance | Destruction | 1,000 m/s ² |
| | Malfunction | 100 m/s ² |
| Endurance | Mechanical | 1,000,000 operations min. (at 1,800 operations/hr) |
| | Electrical *5 | 100,000 operations min. (at 1,800 operations/hr under rated load) |
| Failure rate (P level) (reference value *6) | 100 mA at 5 VDC | |
| Weight | Approx. 90 g: Quick-connect terminal models Approx. 100 g: PCB terminal models Approx. 120 g: Screw terminal models | |

- Note. The values given above are initial values.
 *1. Measurement conditions: 5 VDC, 1 A, voltage drop method.
 *2. Measurement conditions: Rated operating voltage applied, not including contact bounce. Ambient temperature: 23°C
 *3. Measurement conditions: The insulation resistance was measured with a 500-VDC megohmmeter at the same locations as the dielectric strength was measured. JEC-212 (1981) Standard Impulse Wave Type (1.2x50μs).
 *4. Ambient temperature: 23°C
 *5. Ambient temperature: 23°C
 *6. This value was measured at a switching frequency of 60 operations/min.

| | |
|-------------------------------|---|
| Ambient operating temperature | -25°C to 60°C (with no icing or condensation) |
| Ambient operating humidity | 5% to 85% |

■ Engineering Data

G7L-1A-T (TJ) (TUB) (TUBJ) G7L-1A-B (BJ) (BUB) (BUBJ) Maximum Switching Power

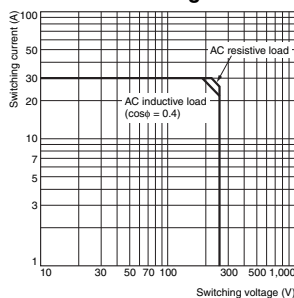

G7L-2A-T (TJ) (TUB) (TUBJ) G7L-2A-B (BJ) (BUB) (BUBJ) Maximum Switching Power

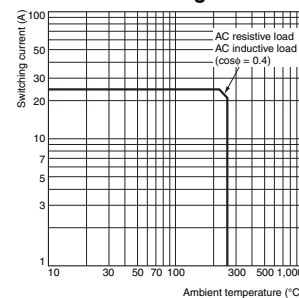

G7L-1A-P G7L-2A-P Maximum Switching Power

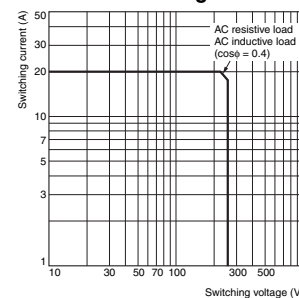

Ambient Temperature vs. Operate and Release Voltage G7L-1A VAC (60 Hz)

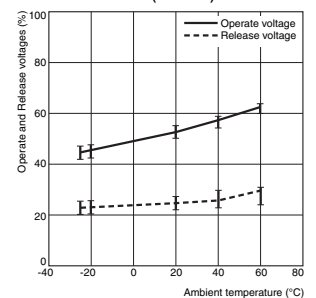

Endurance

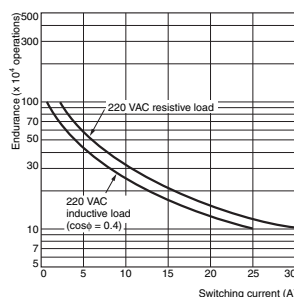

Endurance

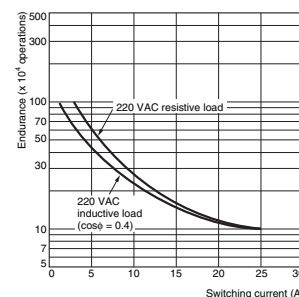

Endurance

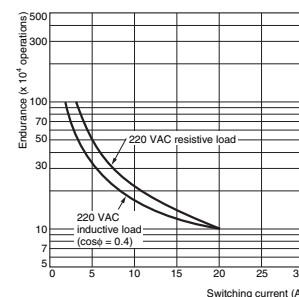

G7L-1A VDC

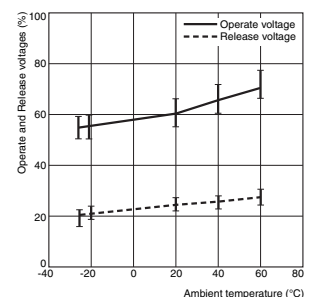

Ambient Temperature vs. Coil Temperature Rise G7L-1A 120 VAC (50 Hz)

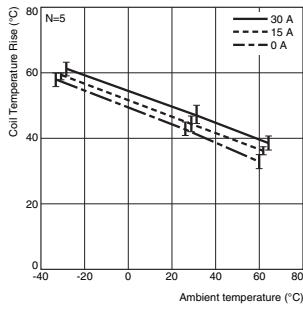

G7L-1A VDC

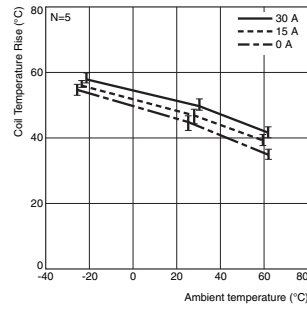

Shock Malfunction G7L-2A-T (TUB) 100 to 120 VAC

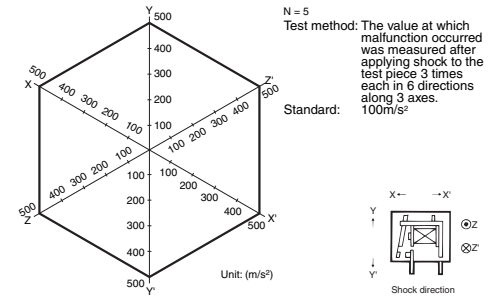

Momentary Voltage Drop Test G7L-2A-T (TUB) 100 to 120 VAC

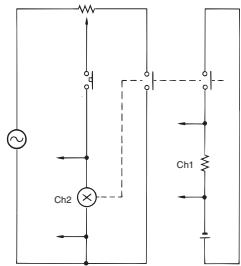

Wave resulted from test

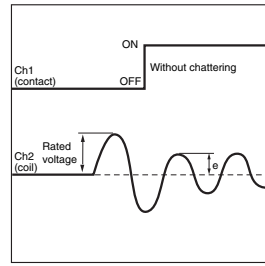

Voltage distribution of wave e which chattering does not occur.

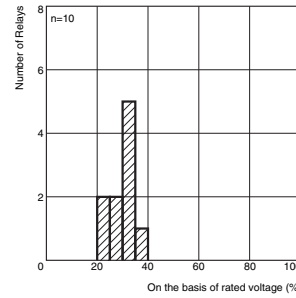

Characteristic variation resulted from different mounting directions G7L-2A-T (TUB) 100 to 120 VAC

Operate time

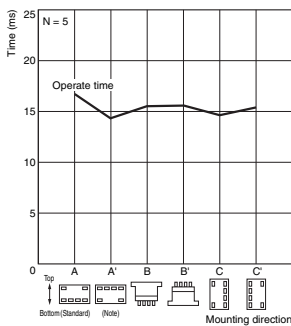

Release time

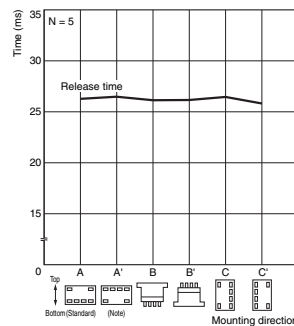

Operate voltage

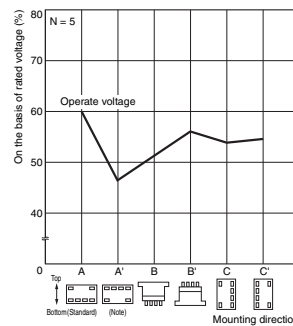

Release voltage

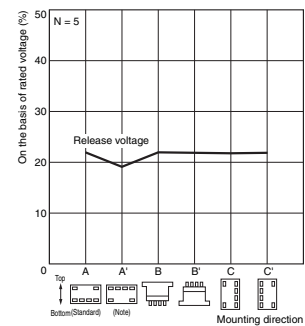

(Note.) The mounting direction A' deteriorates switching performance.

Actual Load Endurance Test G7L-2A 100 to 200 VAC Operate and Release voltages N = 5

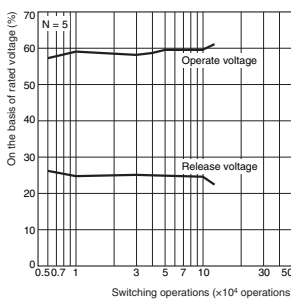

Contact resistance

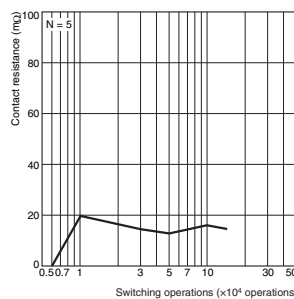

Operate and Release voltages N = 5

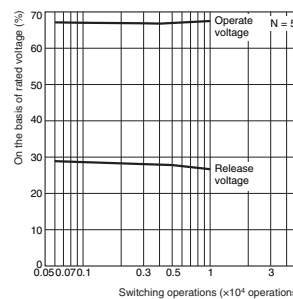

Contact resistance

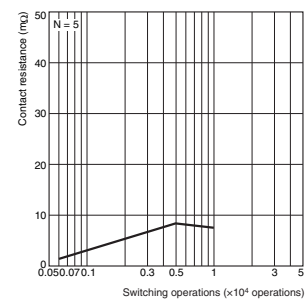

Load conditions

- 1 φ 220 VAC

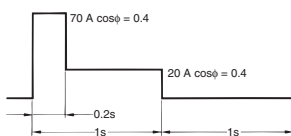

- Applied coil voltage: 100% of rated voltage

Load conditions

- 1 φ 220 VAC

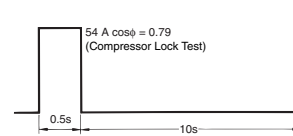

- Applied coil voltage: 100% of rated voltage

G7L-2A 100 to 200 VAC Operate and Release voltages N = 5

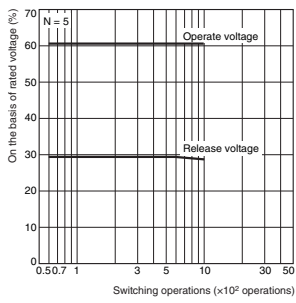

Contact resistance

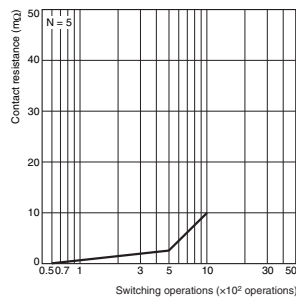

Operate and Release voltages N = 5

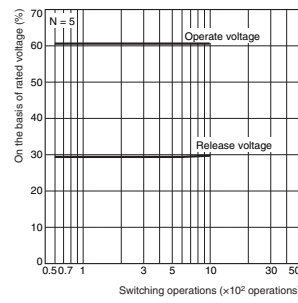

Contact resistance

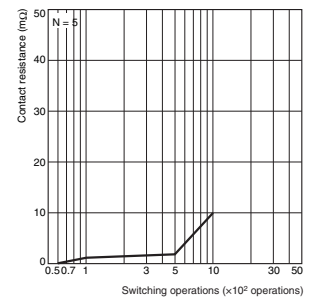

Load conditions

- 1 ϕ 220 VAC

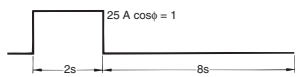

- Applied coil voltage: 75% of rated voltage

Load conditions

- 1 ϕ 220 VAC

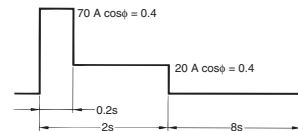

- Applied coil voltage: 75% of rated voltage

Dimensions

- E-bracket Mounting
- Quick-connect Terminals

Note. E-brackets are sold separately.

G7L-1A-T

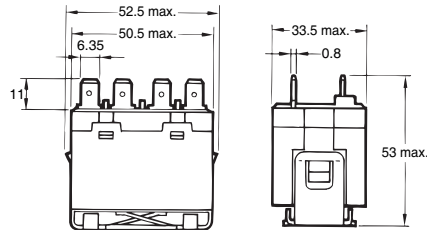
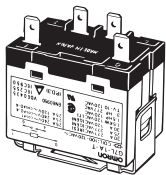

Terminal Arrangement/ Internal Connections (Top View)

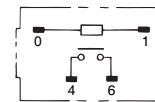

(No coil polarity)
Note. Refer to page 12 for the coil internal connection diagram

G7L-2A-T

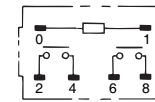
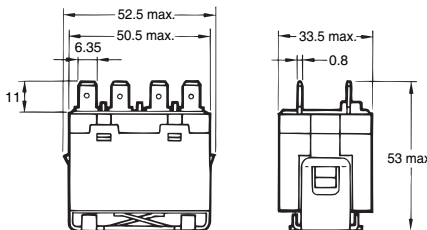
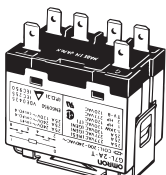

(No coil polarity)
Note. Refer to page 12 for the coil internal connection diagram

Mounting Holes

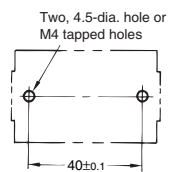

G7L-1A-TJ (with Test Button)

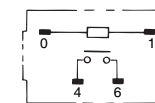
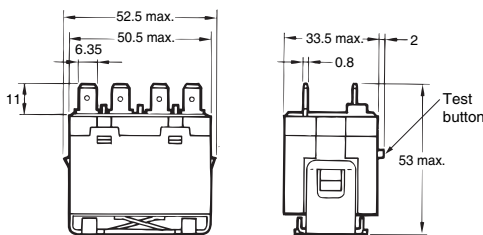
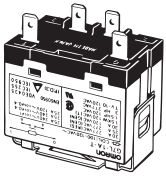

(No coil polarity)
Note. Refer to page 12 for the coil internal connection diagram

G7L-2A-TJ (with Test Button)

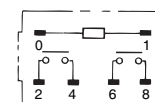
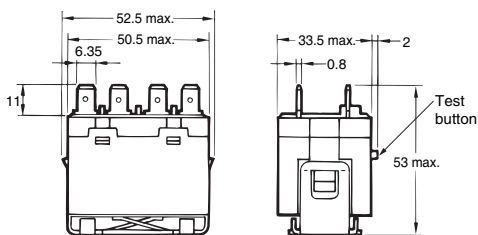
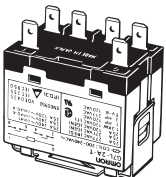

(No coil polarity)
Note. Refer to page 12 for the coil internal connection diagram

● Adapter Mounting Quick-connect Terminals

- Note 1. The DIN Track Mounting Adapter and DIN tracks are sold separately.
 Note 2. The DIN Track Mounting Adapter can be track-mounted or screw-mounted.

G7L-1A-T

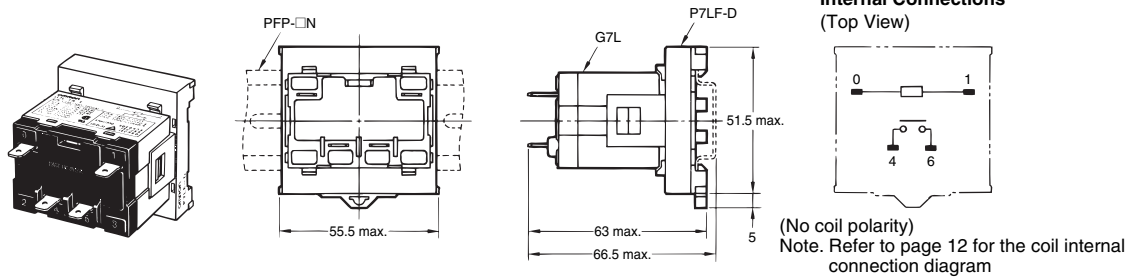

G7L-2A-T

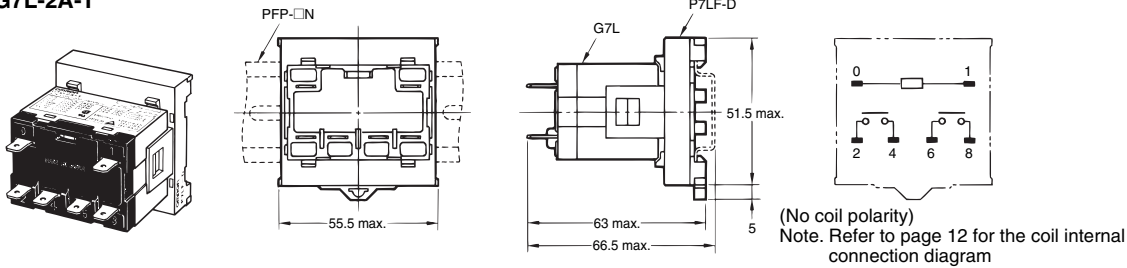

Mounting Holes

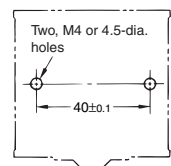

G
7
L

G7L-1A-TJ (with Test Button)

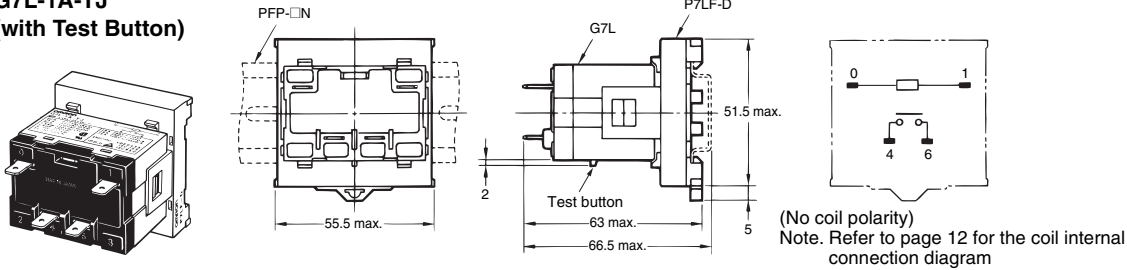

G7L-2A-TJ (with Test Button)

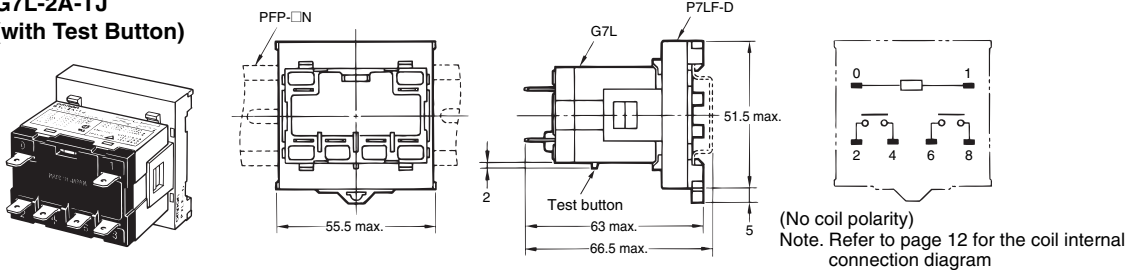

● Front-connecting Socket Mounting Quick-connect Terminals

- Note 1. The Front-connecting Socket and DIN tracks are sold separately.
 Note 2. The Front-connecting Socket can be track-mounted or screw-mounted.

G7L-1A-T

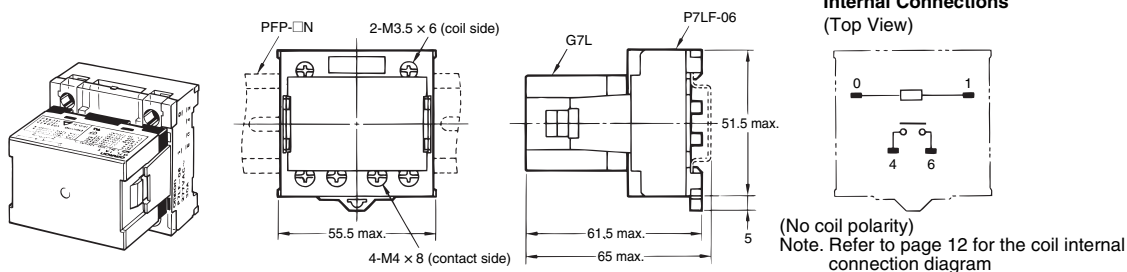

Mounting Holes

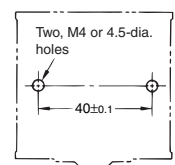

G7L-2A-T

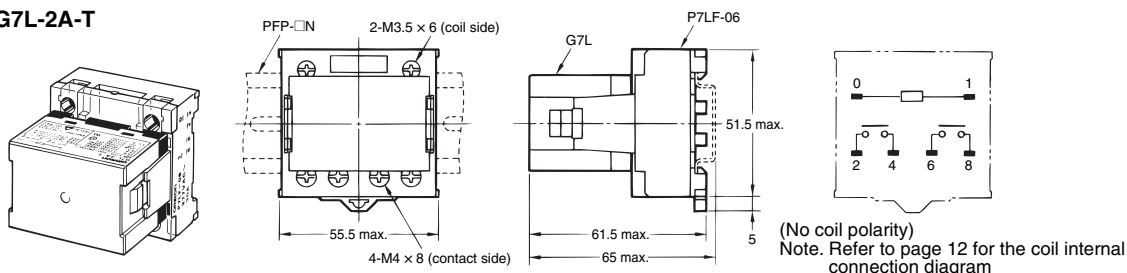

G7L-1A-TJ (with Test Button)

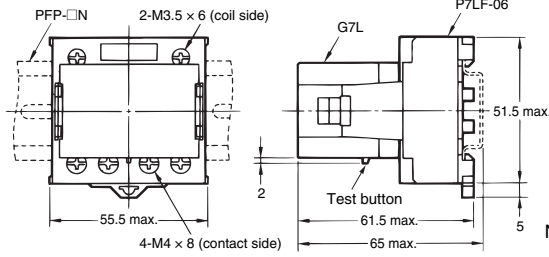
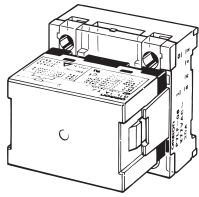

Terminal Arrangement/ Internal Connections (Top View)

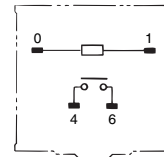

(No coil polarity)
Note. Refer to page 12 for the coil internal connection diagram

Mounting Holes

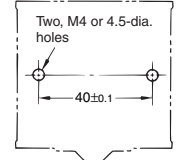

G7L-2A-TJ (with Test Button)

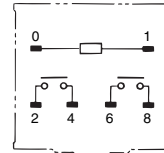
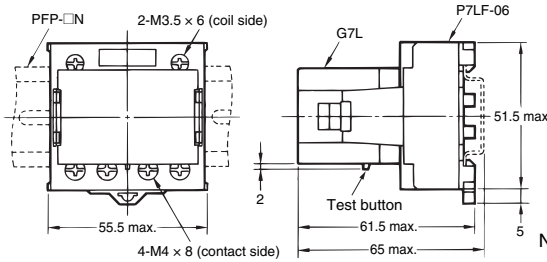
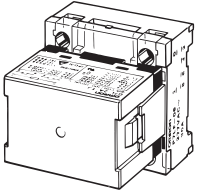

(No coil polarity)
Note. Refer to page 12 for the coil internal connection diagram

● Upper Bracket Mounting Quick-connect Terminals

G7L-1A-TUB

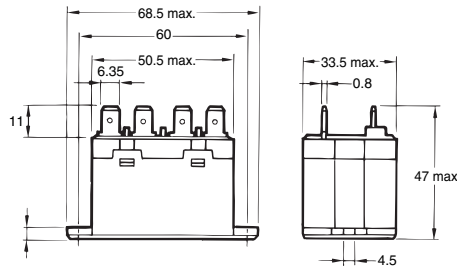
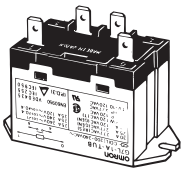

Terminal Arrangement/ Internal Connections (Top View)

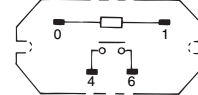

(No coil polarity)
Note. Refer to page 12 for the coil internal connection diagram

G7L-2A-TUB

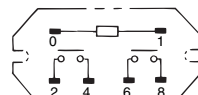
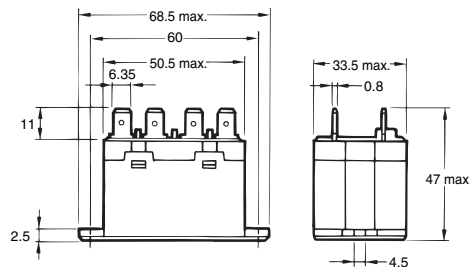
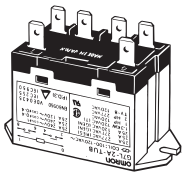

(No coil polarity)
Note. Refer to page 12 for the coil internal connection diagram

Mounting Holes

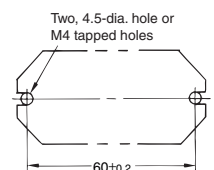

G7L-1A-TUBJ (with Test Button)

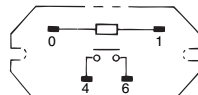
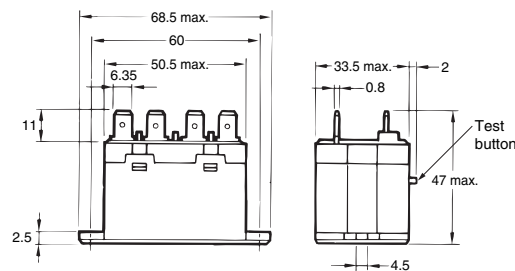
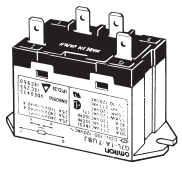

(No coil polarity)
Note. Refer to page 12 for the coil internal connection diagram

G7L-2A-TUBJ (with Test Button)

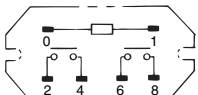
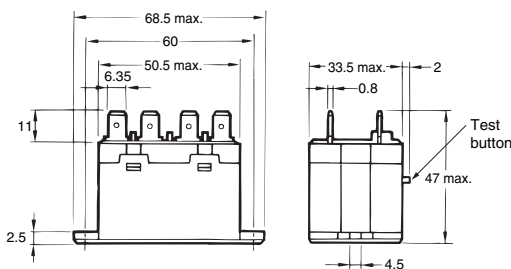
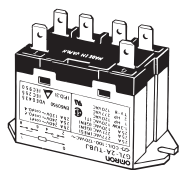

(No coil polarity)
Note. Refer to page 12 for the coil internal connection diagram

E-bracket Mounting Screw Terminals

Note. E-brackets are sold separately.

G7L-1A-B

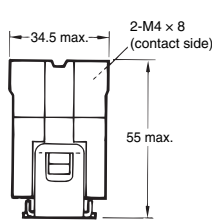
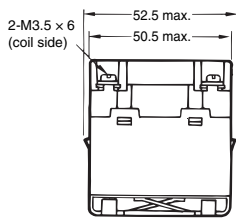
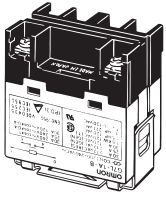

Terminal Arrangement/ Internal Connections (Top View)

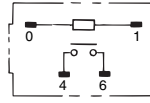

(No coil polarity)
Note. Refer to page 12 for the coil internal connection diagram

G7L-2A-B

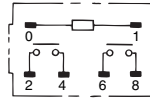
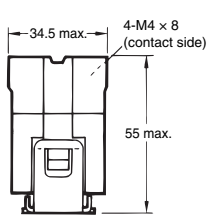
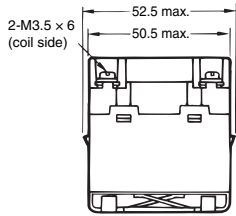
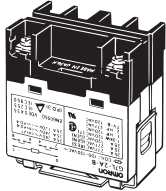

(No coil polarity)
Note. Refer to page 12 for the coil internal connection diagram

Mounting Holes

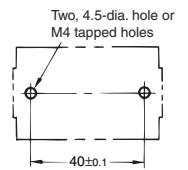

G7L-1A-BJ (with Test Button)

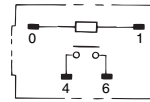
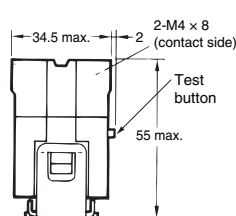
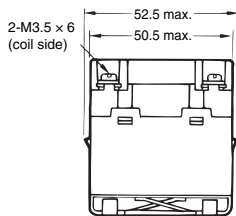
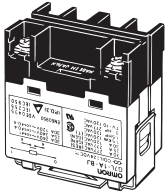

(No coil polarity)
Note. Refer to page 12 for the coil internal connection diagram

G7L-2A-BJ (with Test Button)

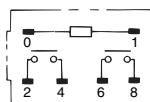
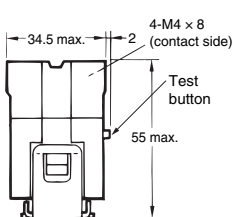
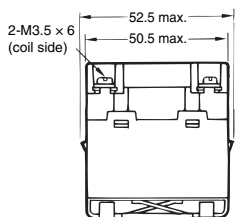
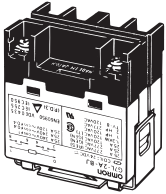

(No coil polarity)
Note. Refer to page 12 for the coil internal connection diagram

Adapter Mounting Screw Terminals

Note 1. The DIN Track Mounting Adapter and DIN tracks are sold separately.
2. The DIN Track Mounting Adapter can be track-mounted or screw-mounted.

G7L-1A-B

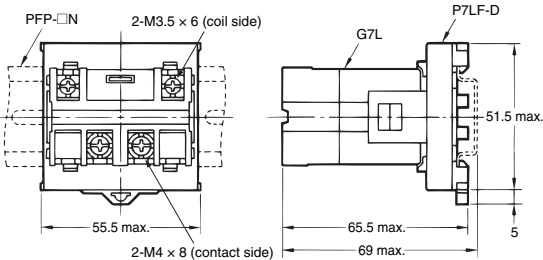
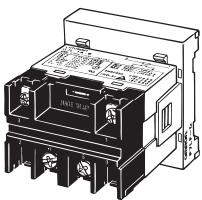

Terminal Arrangement/ Internal Connections (Top View)

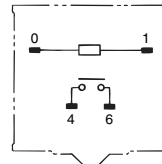

(No coil polarity)
Note. Refer to page 12 for the coil internal connection diagram

Mounting Holes

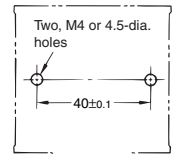

G7L-2A-B

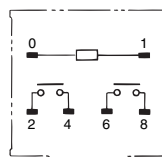
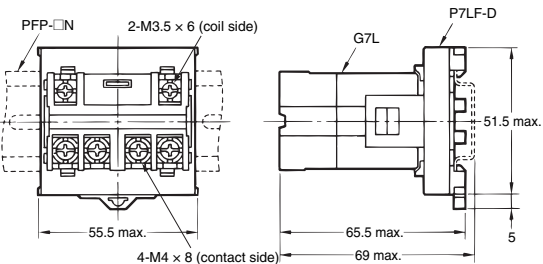
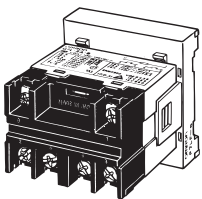

(No coil polarity)
Note. Refer to page 12 for the coil internal connection diagram

G7L-1A-BJ (with Test Button)

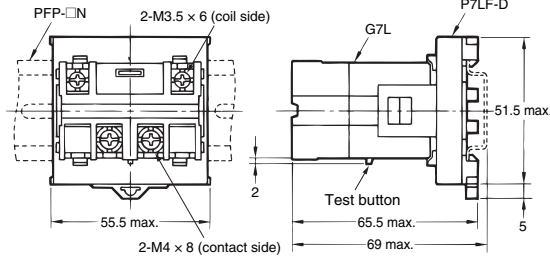
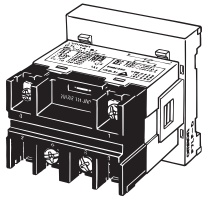

Terminal Arrangement/ Internal Connections (Top View)

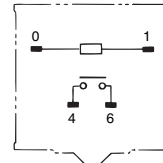

(No coil polarity)
Note. Refer to page 12 for the coil internal connection diagram

Mounting Holes

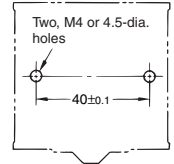

G7L-2A-BJ (with Test Button)

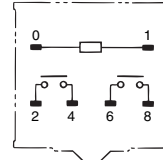
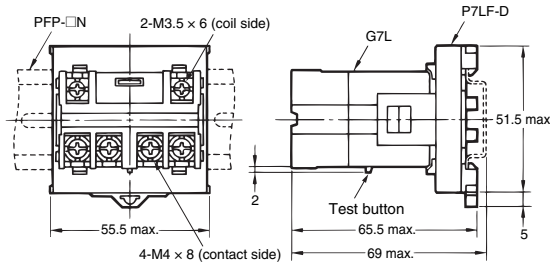
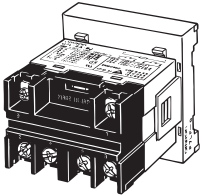

(No coil polarity)
Note. Refer to page 12 for the coil internal connection diagram

● Upper Bracket Mounting Screw Terminals

G7L-1A-BUB

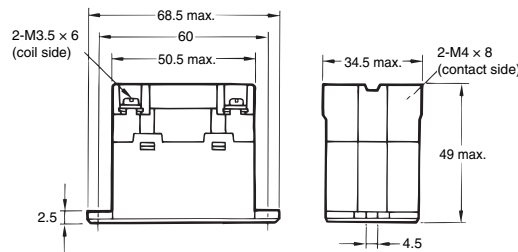
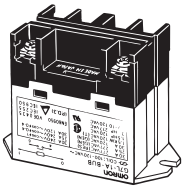

Terminal Arrangement/ Internal Connections (Top View)

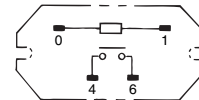

(No coil polarity)
Note. Refer to page 12 for the coil internal connection diagram

G7L-2A-BUB

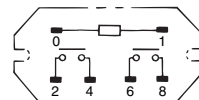
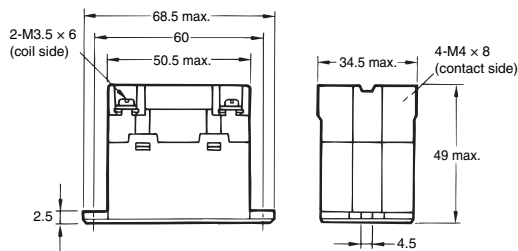
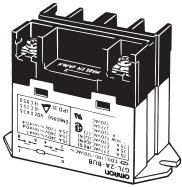

(No coil polarity)
Note. Refer to page 12 for the coil internal connection diagram

Mounting Holes

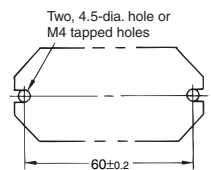

G7L-1A-BUBJ (with Test Button)

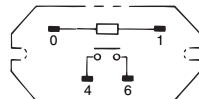
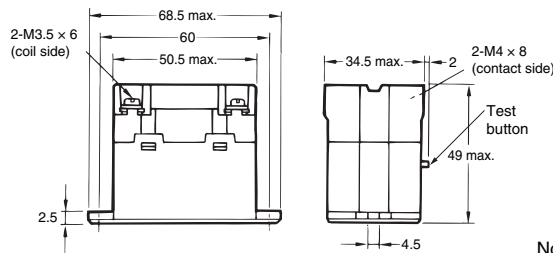
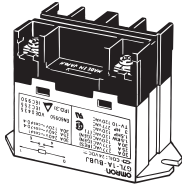

(No coil polarity)
Note. Refer to page 12 for the coil internal connection diagram

G7L-2A-BUBJ (with Test Button)

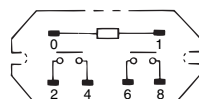
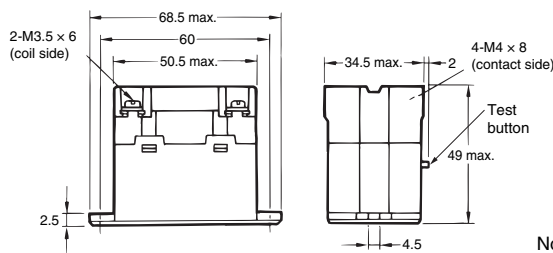
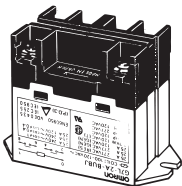

(No coil polarity)
Note. Refer to page 12 for the coil internal connection diagram

● PCB Mounting PCB Terminals

G7L-1A-P

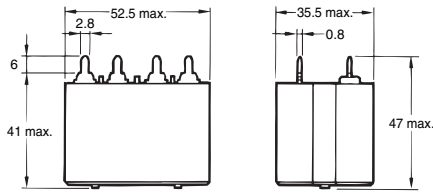
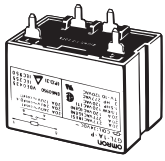

Terminal Arrangement/ Internal Connections (Top View)

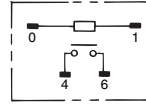

(No coil polarity)
Note. Refer to page 12 for the coil internal connection diagram

PCB Mounting Holes (Bottom View)

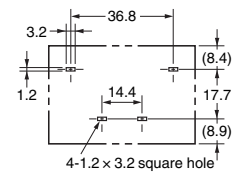

G7L-2A-P

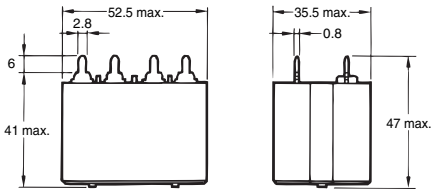
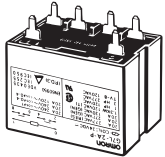

Terminal Arrangement/ Internal Connections (Top View)

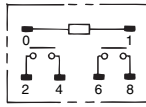

(No coil polarity)
Note. Refer to page 12 for the coil internal connection diagram

PCB Mounting Holes (Bottom View)

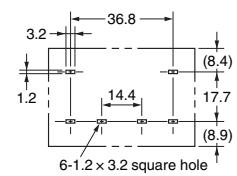

● E-bracket R99-07 (E KANAGU) FOR G7L

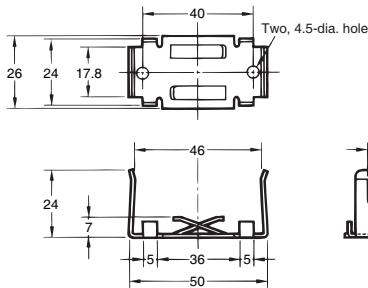
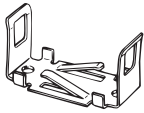

Mounting Holes

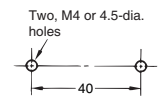

● Adapter P7LF-D

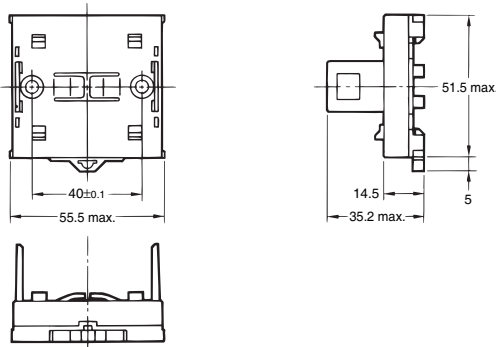
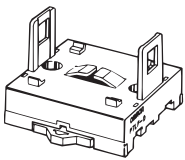

Mounting Holes

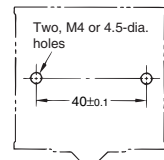

● Front-connecting Socket P7LF-06

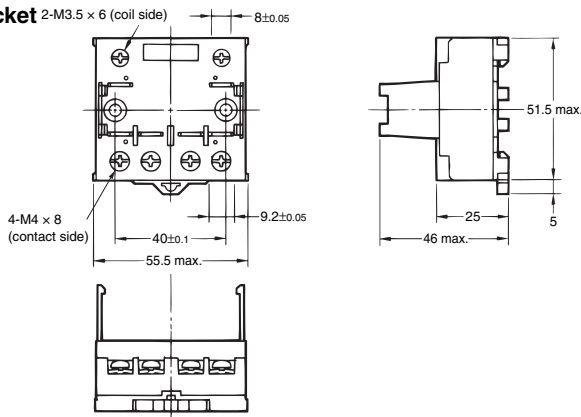
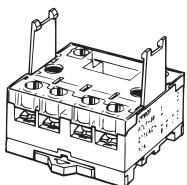

Mounting Holes

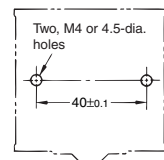

● Cover P7LF-C

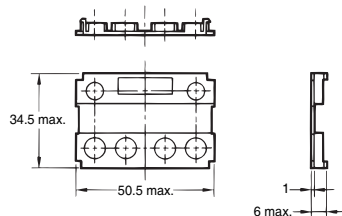
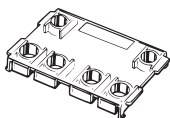

Put the P7LF-C cover onto the terminals in order to protect the user from electric shock.

Approved Standards

· A variety of Safety Standard approved products for standard models.

UL approval  (File No. E41643)

| Model | Coil ratings | Contact ratings | Number of test operations |
|--|-------------------------------|------------------------------|---------------------------|
| | | SPST-NO | |
| G7L-1A-T□ G7L-1A-B□ G7L-1A-P G7L-2A-T□ G7L-2A-B□ G7L-2A-P | 12 to 240 VAC 6 to 220 VDC | 30 A, 277 VAC (RES) 40°C | 100,000 |
| | | 1.5 kW, 120 VAC (T) 40°C | 6,000 |
| | | 1.5 HP, 120 VAC 40°C | 1,000 |
| | | 3 HP 277 VAC 40°C | 100,000 |
| | | 20 FLA/120 LRA, 120 VAC 40°C | 30,000 |
| 17 FLA/102 LRA, 277 VAC 40°C | | | |
| | | TV-10, 120 VAC 40°C | 25,000 |

CSA approval  (File No. LR31928)

| Model | Coil ratings | Contact ratings | Number of test operations |
|------------------------------------|-------------------------------|--------------------------------|---------------------------|
| | | SPST-NO | |
| G7L-1A-P | 12 to 240 VAC 6 to 220 VDC | 2.4 kW, 120 VAC (T) 40°C | 6,000 |
| | | 1.5 HP, 120 VAC (T) 40°C | 1,000 |
| | | 3 HP 277 VAC 40°C | |
| | | 20.5 FLA/105 LRA, 120 VAC 85°C | 100,000 |
| | | TV-10, 120 VAC 40°C | 25,000 |
| G7L-1A-T□ G7L-1A-B□ | 12 to 240 VAC | 30 A, 277 VAC (RES) 40°C | 100,000 |
| | | 2.4 kW, 120 VAC (T) 40°C | 6,000 |
| G7L-2A-T□ G7L-2A-B□ G7L-2A-P | 6 to 220 VDC | 1.5 HP, 120 VAC 40°C | 1,000 |
| | | 3 HP 277 VAC 40°C | |
| | | 20.5 FLA/105 LRA, 120 VAC 85°C | 100,000 |
| | | TV-10, 120 VAC 40°C | 25,000 |

●Reference

UL Approved Type

- UL508 Industrial Control Devices
- UL1950 Information processing equipment
(Including office equipment)

CSA Approved Type.....

- CSA C22.2 No.1, 14
Industrial Control Devices
- CSA C22.2 No.950 Information processing equipment
(Including office equipment)

TÜV EN/IEC Standard Approved Type

- EN61810-1 Relay
- EN60950 Information processing equipment
(Including office equipment)
- IEC950 Information processing equipment
(Including office equipment)

EN/IEC, TÜV Approval  (File No. R50059083)

| Model | Coil ratings | Contact ratings | Approved switching operations |
|-----------|--------------|-----------------------------------|-------------------------------|
| | | SPST-NO | |
| G7L-1A-B□ | | 30 A, 250 VAC ~ (cosφ = 1) 60°C | 50,000 |
| | | 25 A, 250 VAC ~ (cosφ = 0.4) 60°C | |
| G7L-2A-B□ | | 30 A, 120 VAC ~ (cosφ = 0.4) 60°C | 50,000 |
| | | DPST-NO | |
| G7L-1A-T□ | | 25 A, 277 VAC ~ (cosφ = 1) 60°C | 50,000 |
| | | 25 A, 277 VAC ~ (cosφ = 0.4) 60°C | |
| G7L-2A-T□ | | 25 A, 240 VAC ~ (cosφ = 1) 60°C | 50,000 |
| | | 25 A, 240 VAC ~ (cosφ = 0.4) 60°C | |
| G7L-1A-P | | 25 A, 277 VAC ~ (cosφ = 1) 60°C | 50,000 |
| | | 25 A, 277 VAC ~ (cosφ = 0.4) 60°C | |
| G7L-2A-P | | 20 A, 240 VAC ~ (cosφ = 1) 60°C | 50,000 |
| | | 20 A, 240 VAC ~ (cosφ = 0.4) 60°C | |

G
7
L

■Precautions

● Please refer to “PCB Relays Common Precautions” for general precautions.

Correct Use

● Installation

- Although there are not specific limits on the installation site, it should be as dry and dust-free as possible.
- Using in an atmosphere of high temperature, high humidity and corrosive gas may deteriorate its performance characteristic caused by condensation or corrosive products, resulting in failure or burn damage of the Relay.
- PCB Terminal-equipped Relays weigh approximately 100 g. Be sure that the PCB is strong enough to support them. We recommend dual-side through-hole PCBs to reduce solder cracking from heat stress.
- Relays with test buttons must be mounted facing down. Be careful not to touch the test button accidentally. Doing so may turn ON the contact.
- Be sure to use the test button for test purposes only (with test-button models). The test button is used for Relay circuit tests, such as circuit continuity tests. Do not attempt to switch the load with the test button.

● Micro Loads

- The G7L is used for switching power loads, such as motor, transformer, solenoid, lamp, and heater loads. Do not use the G7L for switching micro loads, such as signals.

● Soldering PCB Terminals

- Do not perform automatic soldering but solder manually.
- Do not wash down the entire Relay because it does not have an airtight construction.

● Connecting

- Refer to the following table when connecting a wire with a crimpstyle terminal to the G7L.

| | Screw terminals | Front-connecting Socket |
|---------|-----------------|-------------------------|
| Coil | | |
| Contact | | |

- Allow suitable slack on leads when wiring, and do not apply excessive force to the terminals.

● Tightening torque

Coil: 0.78 to 1.18 N · m

Contact: 0.98 to 1.37 N · m

| Type | Receptacle terminals* | Positive housing |
|------------------------------------|---|--|
| #250 terminals (width: 6.35 mm) | AMP 170333-1 (170327-1) AMP 170334-1 (170328-1) AMP 170335-1 (170329-1) | AMP 172076-1 natural color AMP 172076-4 yellow AMP 172076-5 green AMP 172076-6 blue |

* The numbers shown in parentheses are for air-feeding.

Note 1. The current should be 25 A when using receptacle terminals.

Note 2. Use receptacle terminals or positive housing for cable wiring.

● Reference Data

- The ratio of rated voltage between 100 to 120 VAC are values measured on the basis of 100 VAC.

● Operating Coil

(Coil internal connections diagram)

- AC Coil

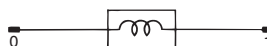

- DC Coil

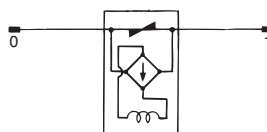

- If a transistor drives the G7L check the leakage current, and connect a bleeder resistor if necessary.
- The AC coil is provided with a built-in full-wave rectifier. If a triac, such as an SSR, drives the G7L, the G7L may not release. Be sure to perform a trial operation with the G7L and the triac before applying them to actual use.

When connecting with screws, if the screws are not sufficiently tightened, the lead wire can become detached and may lead to abnormal heating or fire caused by faulty contact.

- Mounting Torque
0.98N · m
Tighten with two M4 screws when mounting.
(Top bracket type)
- Do not apply excessive force when mounting or dismounting the Faston receptacle. Insert and remove terminals carefully one at a time. Do not insert terminals at an angle, or insert/remove multiple terminals at the same time.
- Do not connect to the terminals by soldering

● DIN Track Mounting Adapter and Front-connecting Socket

(DIN Track Mounting)

- The DIN Track Mounting Adapter and Front-connecting Socket can be mounted on the G7L with just one hand and dismantled with ease by using a screwdriver.
- To support the G7L mounted on a DIN Track Mounting Adapter or Front-connecting Socket, use the PFP-M End Plate. Put the End Plate onto the DIN Track Mounting Adapter or Front-connecting Socket so that the surface mark of the End Plate faces upwards. Then tighten the screw of the End Plate securely with a screwdriver.

(Screw Mounting)

- Screw-mount the DIN Track Mounting Adapter or Front-connecting Socket securely after opening screw mounting holes on them.
- When cutting or opening holes on the panel after the Front-connecting Socket is mounted, take proper measures so that the cutting chips will not fall onto the Relay terminals. When cutting or opening holes on the upper part of the panel, mask the Front-connecting Socket properly with a cover.

Application examples provided in this document are for reference only. In actual applications, confirm equipment functions and safety before using the product. Consult your OMRON representative before using the product under conditions which are not described in the manual or applying the product to nuclear control systems, railroad systems, aviation systems, vehicles, combustion systems, medical equipment, amusement machines, safety equipment, and other systems or equipment that may have a serious influence on lives and property if used improperly. Make sure that the ratings and performance characteristics of the product provide a margin of safety for the system or equipment, and be sure to provide the system or equipment with double safety mechanisms.

Note: Do not use this document to operate the Unit.