

CCM04 MKII

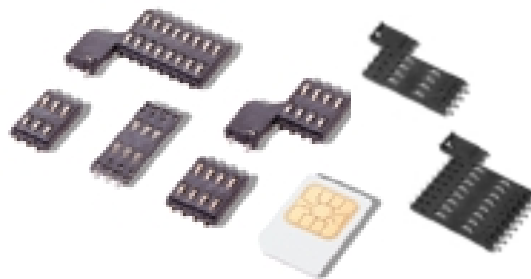

The CCM04 without card guidance is used where space is at a premium and the card guidance can be built around the connector (rather than provided by the connector itself).

The CCM04 low profile without card guidance is dedicated to applications where the overall height of the connector is paramount. A range of low profile CCM04 connectors are available with 1.25 mm thick moldings.

The wide choice of contact configurations and molding heights suit a broad range of applications.

Features

- Available in a variety of molding heights from 1.25 mm to 5 mm.
- The integrated card detection switch (optional) is sealed against dust and grit.
- By using an inlay finish in the contact area, the life of the precious metal is extended by more than 10 times that of standard gold plating.
- The height of the contact above the insulator is 0.75 mm, so allowing a wider tolerance for the card entry slot.
- The contact area is spooned to reduce the risk of accidental (or deliberate) damage, and to optimize the electrical connection with the card.
- The tip of the contact is protected by the molding so that it cannot catch on the card as the card is being inserted.
- The contact design ensures a consistent and reliable contact force over the life of the connector.
- Robustly formed printed circuit tails are well protected by the insulator body: a coplanarity of ± 0.05 mm is guaranteed.
- The moldings are made from high temperature thermoplastic suited for infrared and convection soldering processes.
- With tape and reel packaging as standard, the connectors are designed to be automatically picked & placed.

Construction	
Contacts	Copper alloy
Plating	Contact area : Gold alloy inlay Terminals : Tin lead (2 μ min)
Moldings	High temp. thermoplastic UL 94V-0 rated
Mechanical data	
Number of Contacts	6, 8 or 16
Mechanical life	50,000 cycles min
Durability of inlay	5,000 cycles min (see note 1)
Contact force	0.25 N min / 0.5 N max
Card detection switch actuation force	0.8 N max for actuation (end travel switch actuates when card is 0.9 mm from card stop) 1.8 N max for complete depression
Vibration 50m/s ²	Frequency 10 to 500 Hz. Acceleration Duration 6 hours - amplitude 0.35 mm Max electrical discontinuity 1 μ s
Shock	Peak value 500 m/s ² - Duration 11 ms 3 shocks in each direction of each axis Max electrical discontinuity 1 μ s
Electrical data	
Insulation resistance	1,000 M Ω min
Contact resistance max	100 m Ω max
Switching current	10 μ A min / 1 A max
Dielectric strength	750 Vrms min
Card detection switch	Normally open (closes on card insertion)
Switch contact resistance	100m Ω max
Dielectric switch contacts	250 Vrms min
Maximum switch power	0.2 VA
Environmental data	
Operating temperature	-40°C to +85°C
Soldering temperature	Temperature/time profile acc. to CECC00802 para. 6.1, Fig. 3 with peak temperature 250°C
Damp heat	IEC 512 test number 11c (10 days)
Salt mist	IEC 512 test number 11f (96 hours)
Card detection switch	Sealed IP 54 For CCM04 1889 & 1905 Sealed against dust for other versions

Note 1: Inlay (precious metal) rating is based on a very abrasive card being used and is intended to represent worst case.

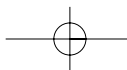

CCM04 MKII

Ordering code					
Molding Height	SMT Tails	Without Switch		With Switch	
		2 x 3 contacts	2 x 4 contacts	2 x 4 contacts	2 x 8 contacts
1.25 mm	Standard	CCM04-1801	CCM04-1814	CCM04-1889	CCM04-1905
1.25 mm	Straight	CCM04-1800*	CCM04-1813*	CCM04-1888*	
2.00 mm	Standard	CCM04-5004**	CCM04-1415*		
2.75 mm	Straight	CCM04-1200	CCM04-1217*	CCM04-1316	CCM04-1333*
2.75 mm	Standard	CCM04-1201	CCM04-1218	CCM04-1317	CCM04-1334
3.50 mm	Standard	CCM04-1202	CCM04-1219*	CCM04-1318	
4.25 mm	Standard	CCM04-1203*	CCM04-1220	CCM04-1319*	
5.00 mm	Standard		CCM04-1221	CCM04-1320	

*Note: On request

**Note: Replaced by CCM04-5102 (see page 53)

Packaging

Connectors without a switch are packaged in accordance with EIA 481-2 or IEC 286-3.

Connectors with a switch are packaged in accordance with EIA 481-3 or IEC 286-3

Standard packaging is in tape and reel. A modification code is added to the part number that indicates reel packaging and the number of components per reel (which varies according to the molding height).

Example: A CCM04 with 8 contacts plus switch and a molding height of 3.50 mm has a part number CCM04-1318-R751.

Molding Height	SMT Tails	Without Switch		With Switch		N° reels per box
		2 x 3 contacts	2 x 4 contacts	2 x 4 contacts	2 x 8 contacts	
1.25 mm	Standard	R182 (1800pcs)	R132 (1300pcs)	R102 (1000pcs)	R651 (650pcs)	5
1.25 mm	Straight	R182 (1800pcs)	R132 (1300pcs)	R102 (1000pcs)		5
2.00 mm	Standard	R122 (1200pcs)	R901 (900pcs)			5
2.75 mm	Straight	R122 (1200pcs)	R901 (900pcs)	R801 (800pcs)	R451 (450pcs)	5
2.75 mm	Standard	R122 (1200pcs)	R901 (900pcs)	R801 (800pcs)	R451 (450pcs)	5
3.50 mm	Standard	R112 (1100pcs)	R801 (800pcs)	R751 (750pcs)		5
4.25 mm	Standard	R951 (950pcs)	R701 (700pcs)	R651 (650pcs)		5
5.00 mm	Standard		R651 (650pcs)	R601 (600pcs)		5

R = Reel

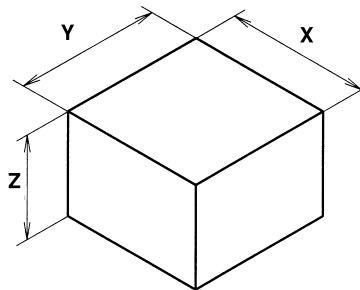
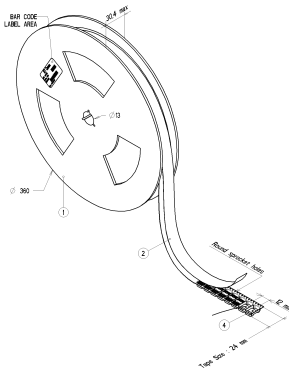

Reel Diameter	Reel Width	X	Y	Z
360 mm	24.4 mm	344 mm	350 mm	152



Cannon

Dimensions are shown in mm
Dimensions subject to change

www.ittcannon.com/ccm

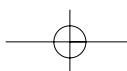

CCM04 MK II Low Profile

Dimensional Drawings

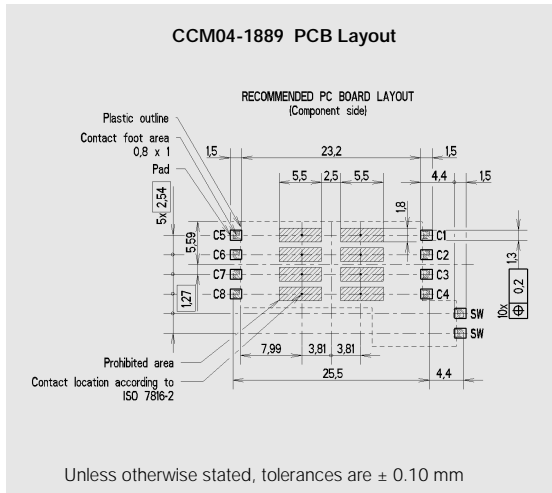
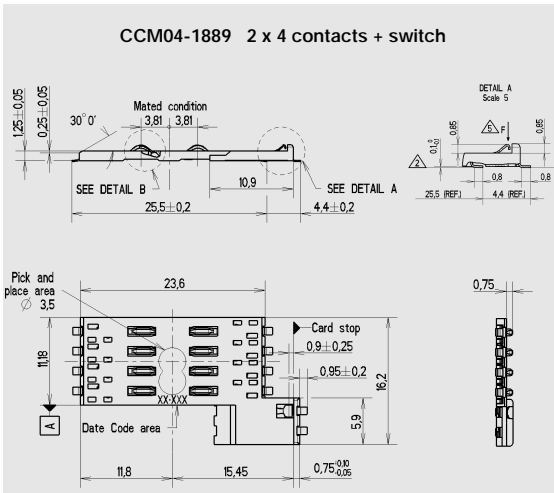
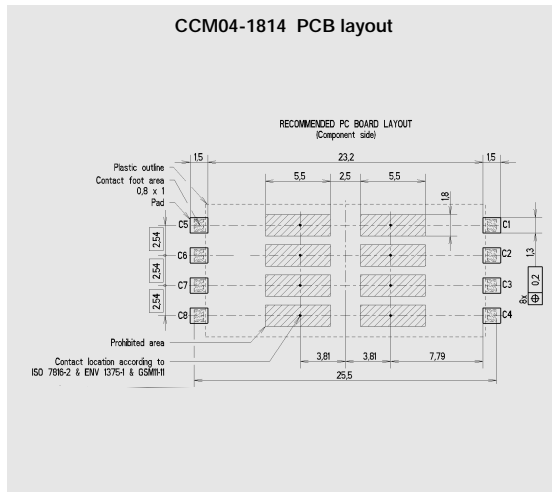
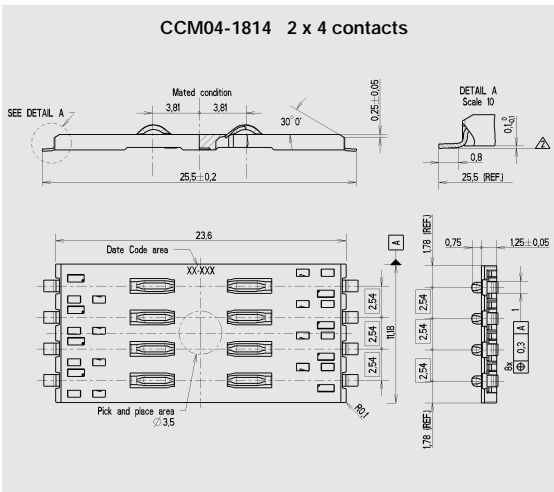
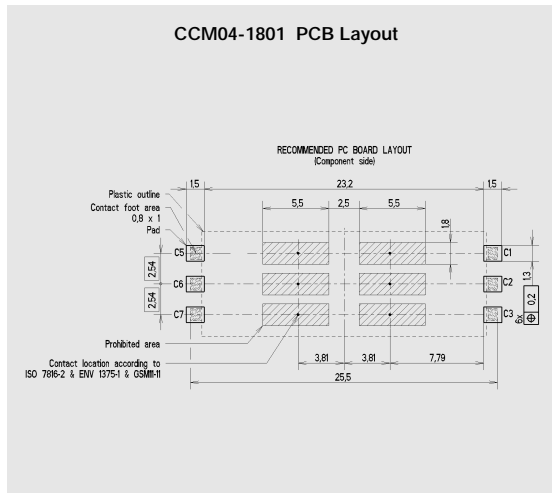
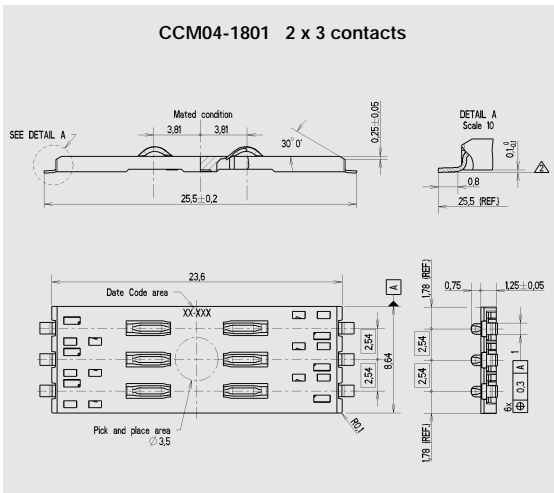

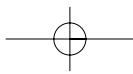

CCM04 MK II Low Profile

Dimensional Drawings

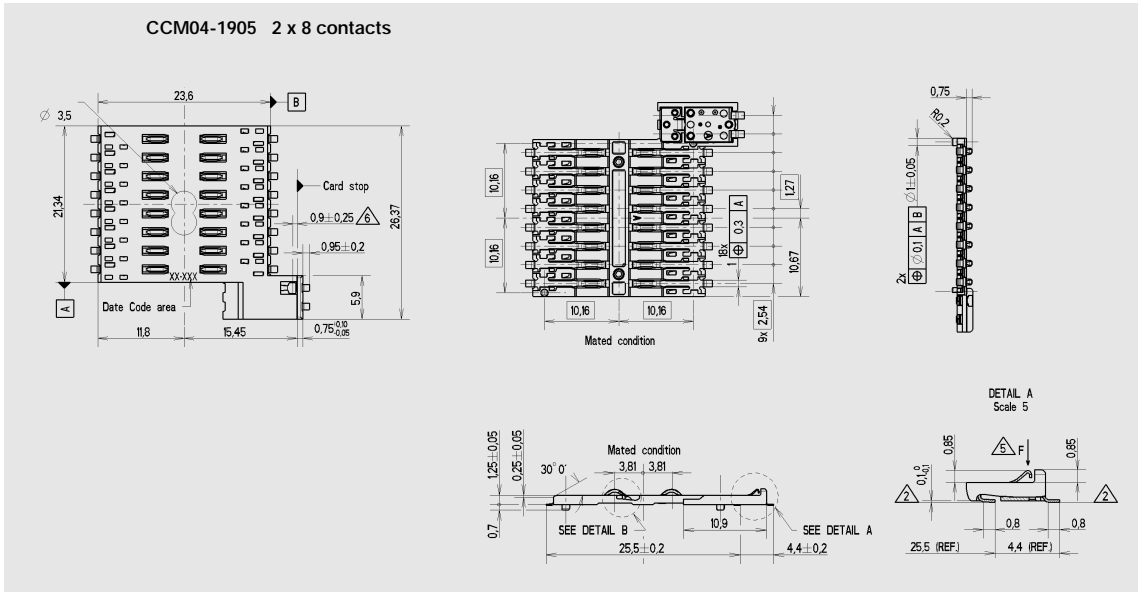

PCB Layout

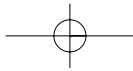
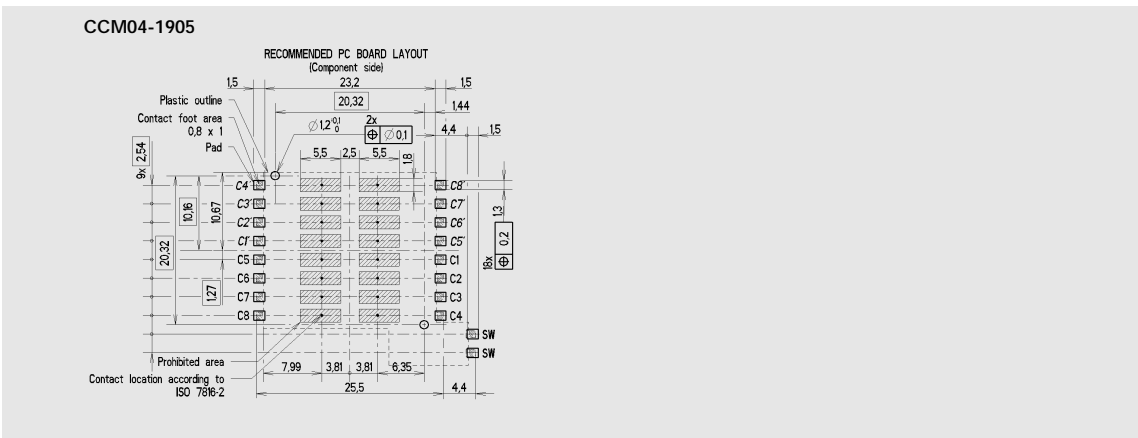

CCM04 MK II

Dimensional Drawings

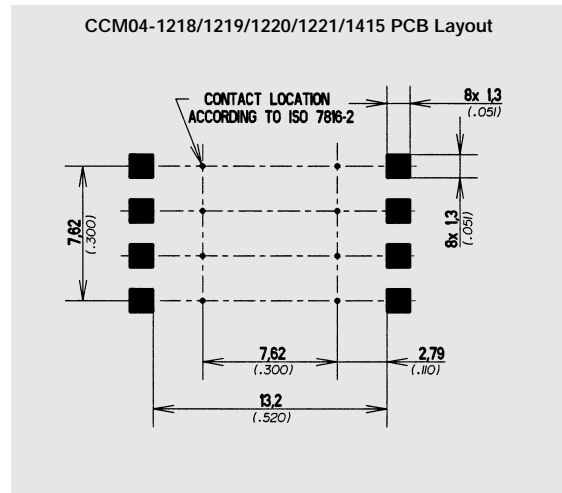
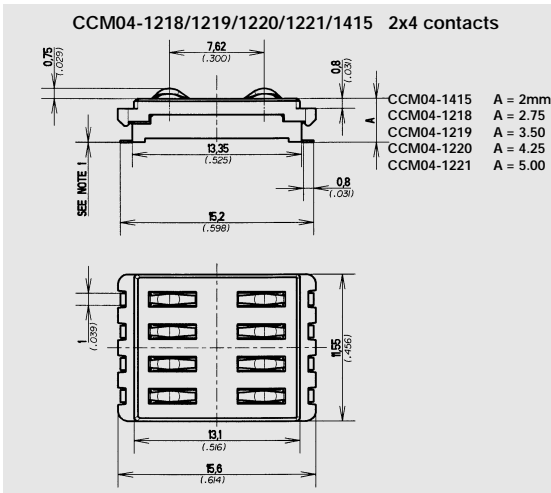
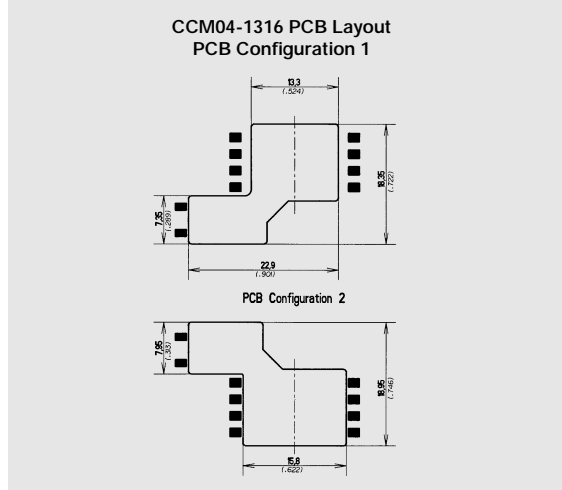
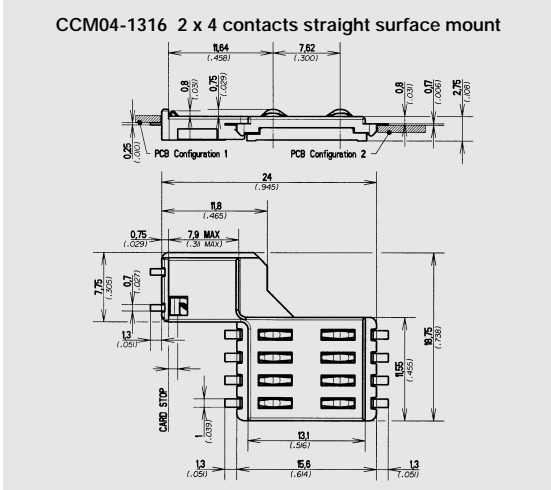
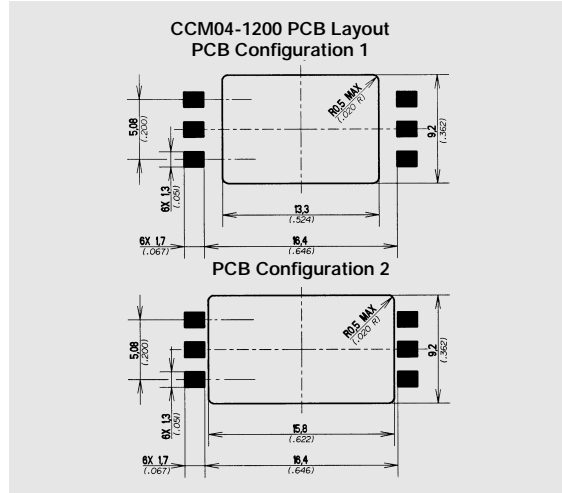
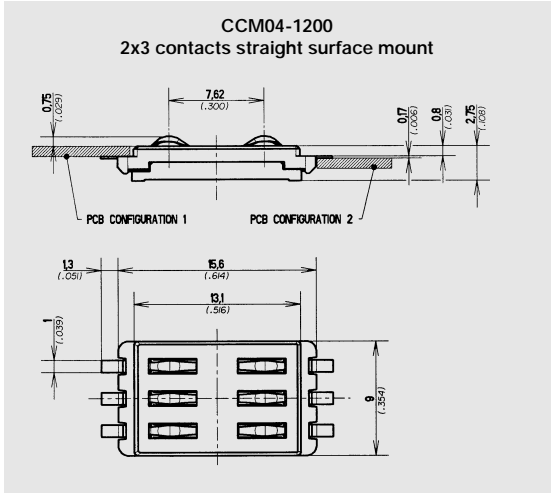

CCM04 MK II

Dimensional Drawings

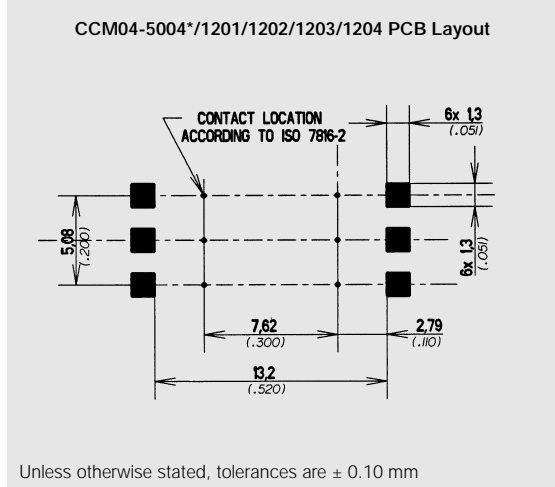
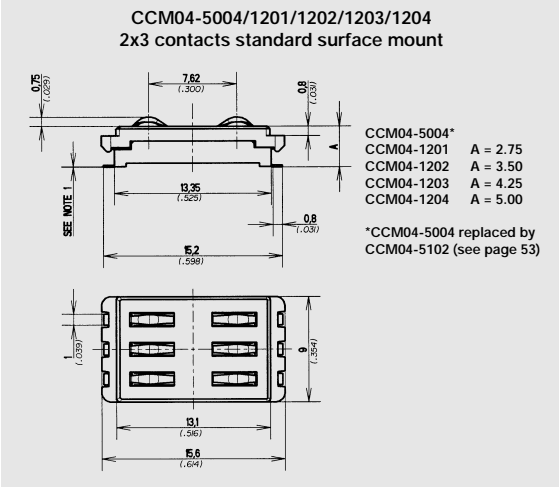
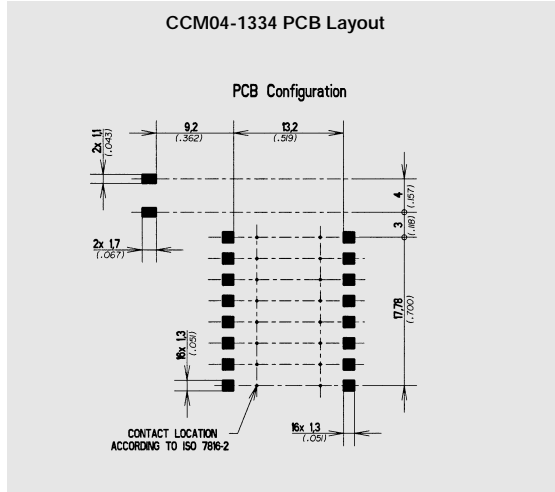
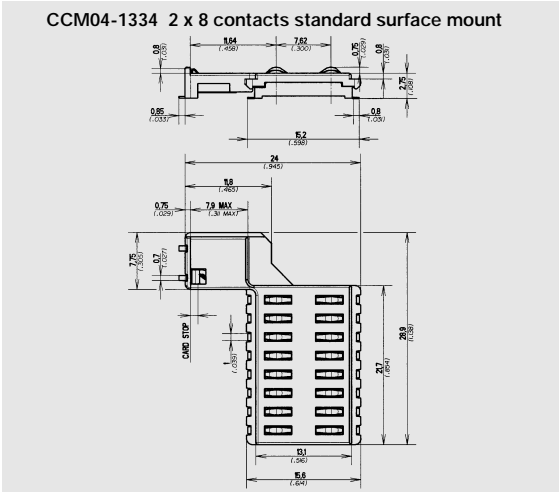
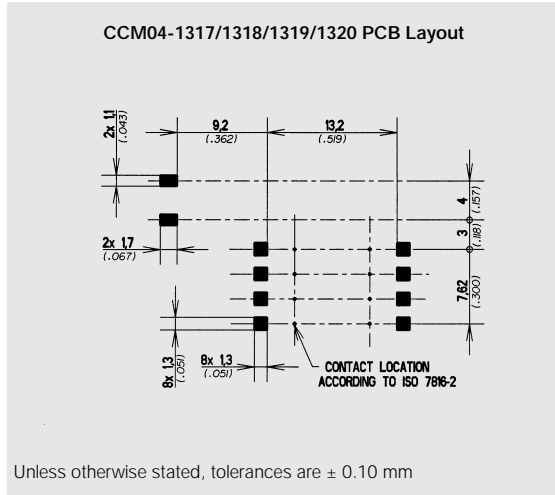
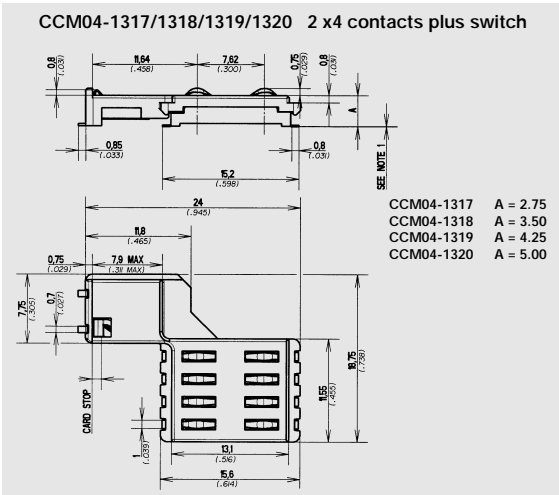

CCM04 MK III Miniature Connectors



Introducing a new range of CCM04 connectors designed to interface with either full or SIM/SAM smart cards and designed to minimize space usage on the PCB while maximizing price economy.

Features

- Available with 6 or 8 contacts.
- By using an inlay finish in the contact area, the life of the precious metal is extended by up to 10 times that of a standard gold plating.
- The contact area is spooned to reduce the risk of accidental (or deliberate) damage and to optimize the electrical connection with the card.
- The insulators, molded from high temperature thermoplastic, are suited for infrared and convection soldering processes.
- With tape and reel packaging as standard, the connectors are designed to be automatically pick and placed.
- Gold plating versions are also available.

Construction

Insulator	High temperature thermoplastic UL 94V.0
Contacts	Copper Alloy
Contact finish	Gold Alloy Inlay (Au / Ag / Pd)
PC Tail plating	Tin lead (2 μ m min) Sn / Pb

Mechanical data

Mechanical life	50,000 cycles minimum
Precious metal	5000 cycles minimum (see note 1)
Contact force	0.25N min / 0.5N max
Contact travel	0.75mm

Electrical data

Insulation resistance	1000 M Ω min
Contact resistance max	100 m Ω max
Switching current	10 μ A min / 1 A max
Dielectric strength	500 Vrms min

Environmental data

Operating temperature	-40°C to +85°C
Soldering temperature	Temperature/time profile acc. to CECC00802 para. 6.1, Fig. 3 with peak temperature
Salt mist	IEC 512 test number 11f (96 hours)
Damp heat	IEC 512 test number 11c (10 days)

CCM04 MK III

6 Contacts Versions

Part Number	N° of Contacts	Total Height	Total Length	Terminal Design	Contact Plating		Insulator Width	Packaging	Modification Code
					Inlay	Gold			
CCM04-4105	6	1.90	11.8	SMT IN	X		7.62	2400	R242
CCM04-5137	6	1.90	11.8	SMT IN		X	7.62	2400	R242
CCM04-4118	6	1.90	14.3	SMT OUT	X		7.62	2400	R242
CCM04-5102*	6	1.90	15.2	SMT OUT		X	7.62	2400	R242
CCM04-5111	6	1.90	14.3	SMT OUT		X	7.62	2400	R242
CCM04-4106	6	2.10	11.8	SMT IN	X		7.62	1900	R192
CCM04-5116	6	2.10	11.8	SMT IN		X	7.62	1900	R192
CCM04-4119	6	2.10	14.3	SMT OUT	X		7.62	1900	R192
CCM04-5112	6	2.10	14.3	SMT OUT		X	7.62	1900	R192
CCM04-4120	6	2.40	14.3	SMT OUT	X		7.62	1900	R192
CCM04-5120	6	2.40	14.3	SMT OUT		X	7.62	1900	R192
CCM04-5106	6	2.50	11.8	SMT IN		X	7.62	1900	R192
CCM04-5114	6	2.50	11.8	SMT IN	X		7.62	1900	R192
CCM04-4121	6	2.65	14.3	SMT OUT	X		7.62	1900	R192
CCM04-5121	6	2.65	14.3	SMT OUT		X	7.62	1900	R192
CCM04-5115	6	2.80	11.8	SMT IN		X	7.62	1900	R192
CCM04-5134	6	2.80	11.8	SMT IN	X		7.62	1900	R192
CCM04-4122*	6	2.90	14.3	SMT OUT	X		7.62	1600	R162
CCM04-5122*	6	2.90	14.3	SMT OUT		X	7.62	1600	R162

8 Contacts Versions

Part Number	N° of Contacts	Total Height	Total Length	Terminal Design	Contact Plating		Insulator Width	Packaging	Modification Code
					Inlay	Gold			
CCM04-4135*	8	1.90	11.8	SMT IN	X		10.16	2400	R242
CCM04-5123*	8	1.90	11.8	SMT IN		X	10.16	2400	R242
CCM04-4148*	8	1.90	14.3	SMT OUT	X		10.16	2400	R242
CCM04-5129*	8	1.90	14.3	SMT OUT		X	10.16	2400	R242
CCM04-4136	8	2.10	11.8	SMT IN	X		10.16	1900	R192
CCM04-5113	8	2.10	11.8	SMT IN		X	10.16	1900	R192
CCM04-4149	8	2.10	14.3	SMT OUT	X		10.16	1900	R192
CCM04-5130	8	2.10	14.3	SMT OUT		X	10.16	1900	R192
CCM04-4150	8	2.40	14.3	SMT OUT	X		10.16	1900	R192
CCM04-5131	8	2.40	14.3	SMT OUT		X	10.16	1900	R192
CCM04-5109	8	2.50	11.8	SMT IN	X		10.16	1900	R192
CCM04-5125	8	2.50	11.8	SMT IN		X	10.16	1900	R192
CCM04-4151	8	2.65	14.3	SMT OUT	X		10.16	1900	R192
CCM04-5132	8	2.65	14.3	SMT OUT		X	10.16	1900	R192
CCM04-5108	8	2.80	11.8	SMT IN	X		10.16	1900	R192
CCM04-5127	8	2.80	11.8	SMT IN		X	10.16	1900	R192
CCM04-4152*	8	2.90	14.3	SMT OUT	X		10.16	1600	R162
CCM04-5133*	8	2.90	14.3	SMT OUT		X	10.16	1600	R162

Note: *Versions on request

CCM04 MK III

2 x 3 contacts SMT IN

Height	Inlay	Gold
1.90 mm	CCM04-4105	CCM04-5137

Height	Inlay	Gold
2.1 mm	CCM04-4106	CCM04-5116

Dimensional Drawings

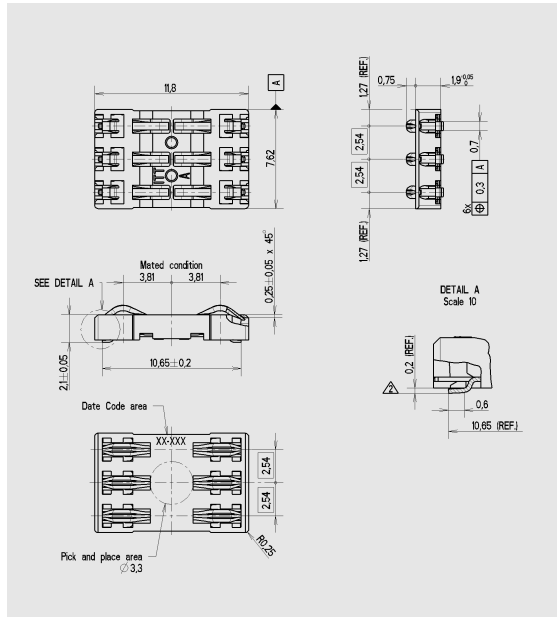
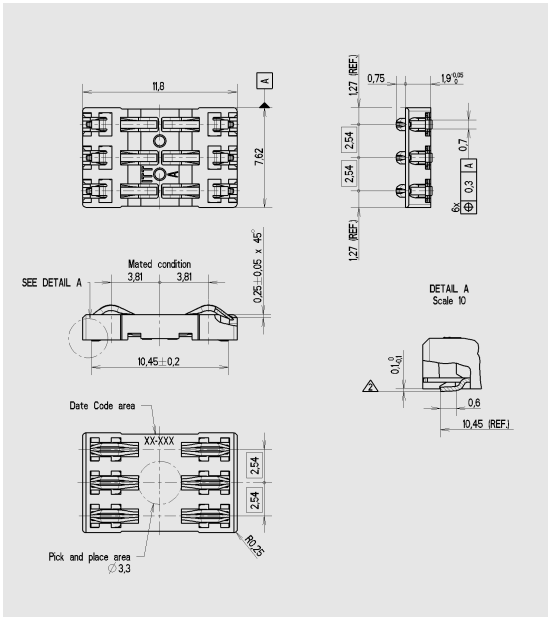

PCB Layout

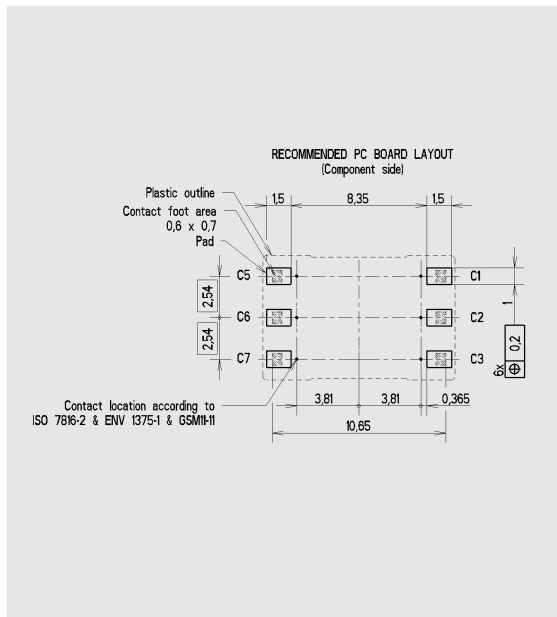
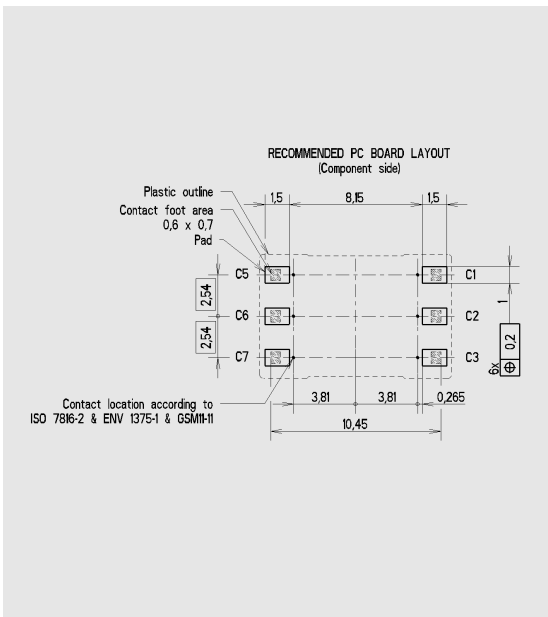

Note: * Versions on request



Cannon

Dimensions are shown in mm
Dimensions subject to change

www.ittcannon.com/ccm

CCM04 MK III

2 x 3 contacts SMT IN

Height A	Height B	Inlay	Gold
2.4 mm	0.5 mm	CCM04-4107*	CCM04-5117*
2.5 mm	0.6 mm	CCM04-5114	CCM04-5106
2.65 mm	0.75 mm	CCM04-4108*	CCM04-5118*
2.9 mm	1 mm	CCM04-4109*	CCM04-5119*
3.15 mm	1.25 mm	CCM04-4110*	CCM04-5107*

Height	Inlay	Gold
2.8 mm	CCM04-5134	CCM04-5115

Dimensional Drawings

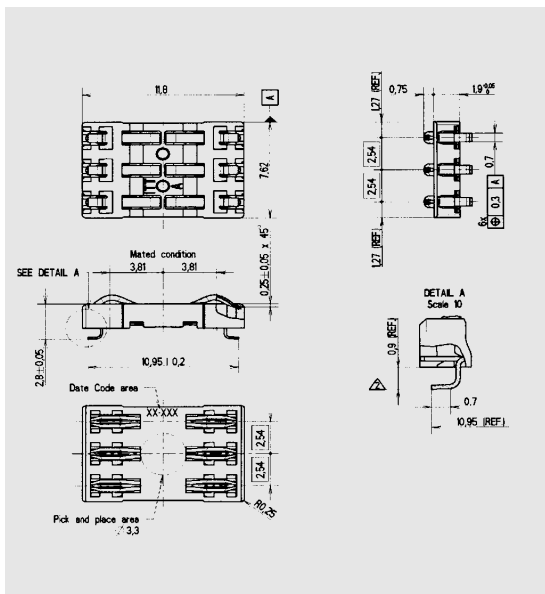
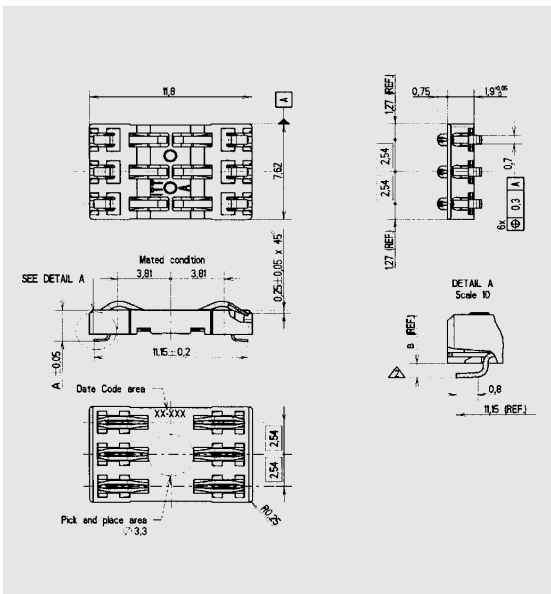

PCB Layout

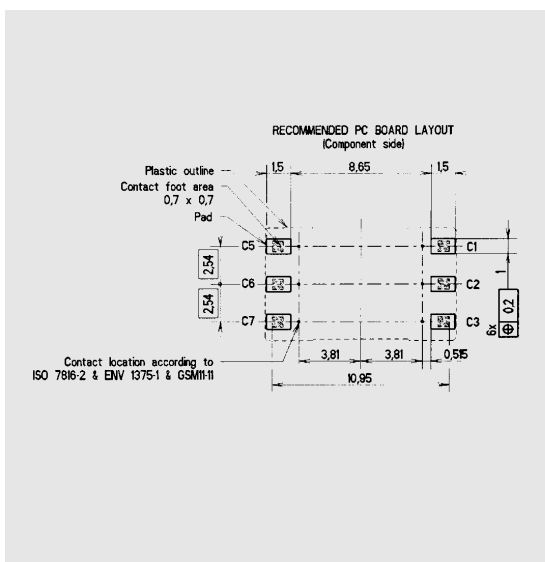
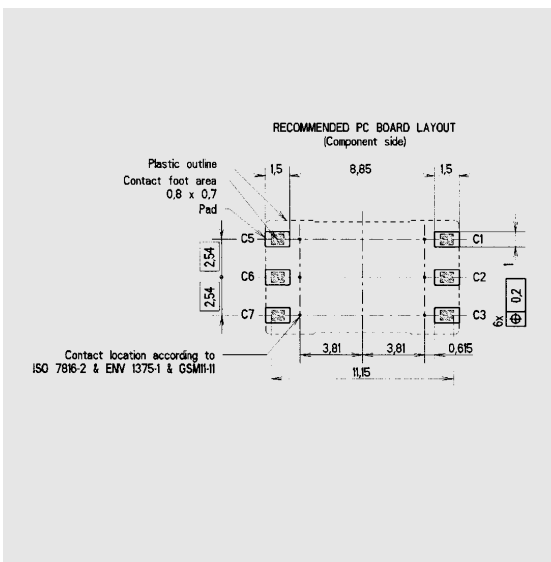

Note: * Versions on request



Cannon

Dimensions are shown in mm
Dimensions subject to change

www.ittcannon.com

CCM04 MK III

2 x 3 contacts SMT OUT

Height A	Height B	Inlay	Gold
1.9 mm	0.1 mm	CCM04-4118	CCM04-5111
2.1 mm	0.2 mm	CCM04-4119	CCM04-5112
2.4 mm	0.5 mm	CCM04-4120	CCM04-5120
2.65 mm	0.75 mm	CCM04-4121	CCM04-5121
2.9 mm	1.0 mm	CCM04-4122*	CCM04-5122*

2 x 3 contacts SMT OUT LONG

Height	Inlay	Gold
1.9 mm		CCM04-5102*

Dimensional Drawings

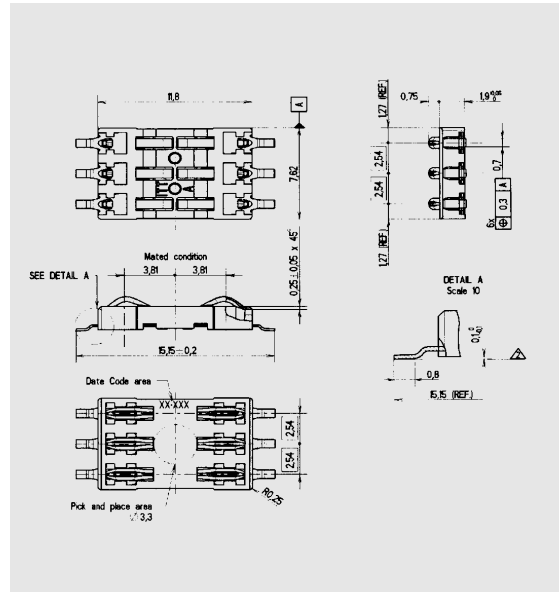
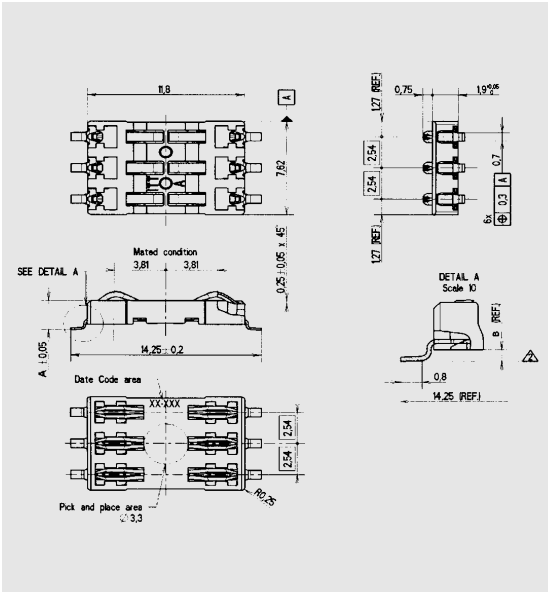

PCB Layout

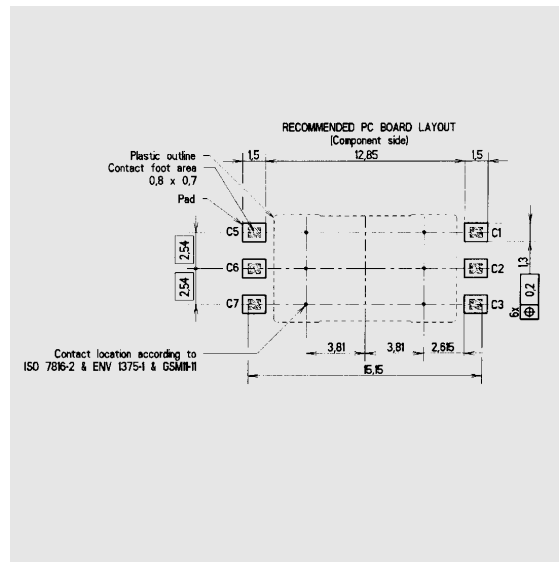
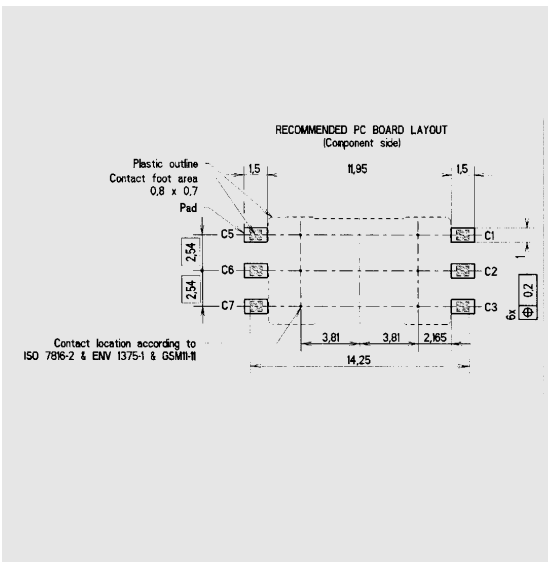

Note: * Versions on request



Cannon

Dimensions are shown in mm
Dimensions subject to change

www.ittcannon.com

CCM04 MK III

2 x 4 contacts SMT IN

Height	Inlay	Gold
1.90 mm	CCM04-4135	CCM04-5123

Height	Inlay	Gold
2.1 mm	CCM04-4136	CCM04-5113

Dimensional Drawings

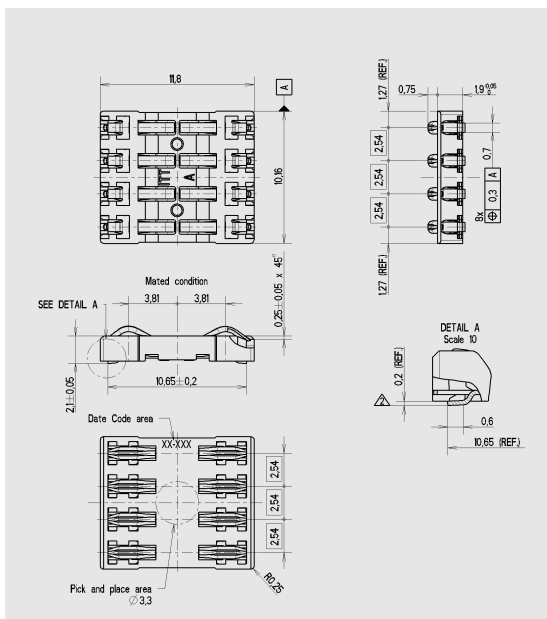
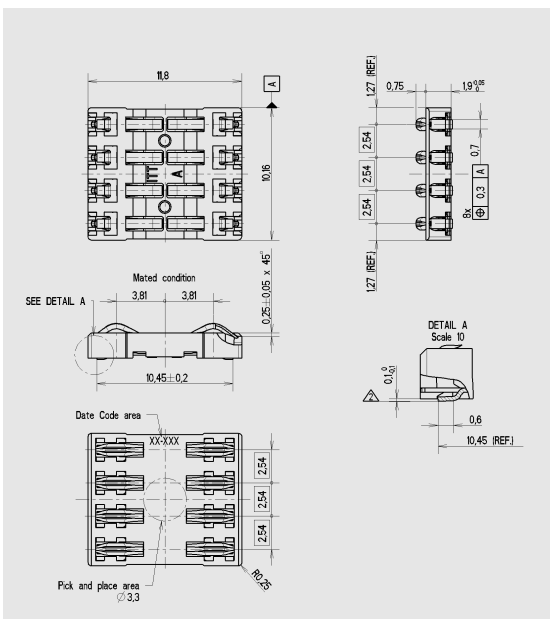

PCB Layout

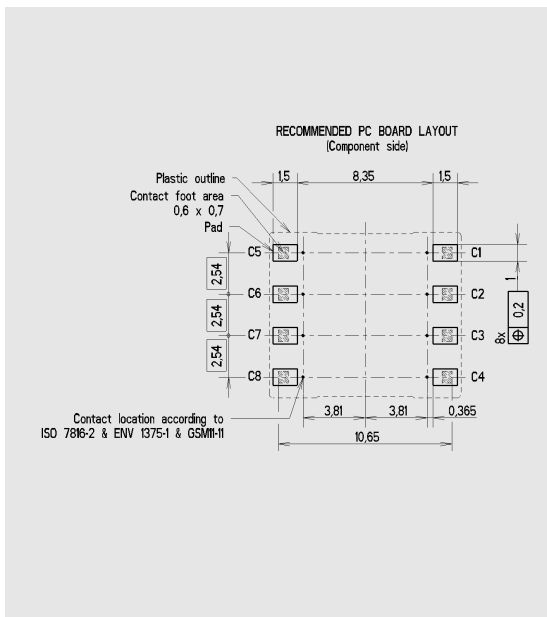
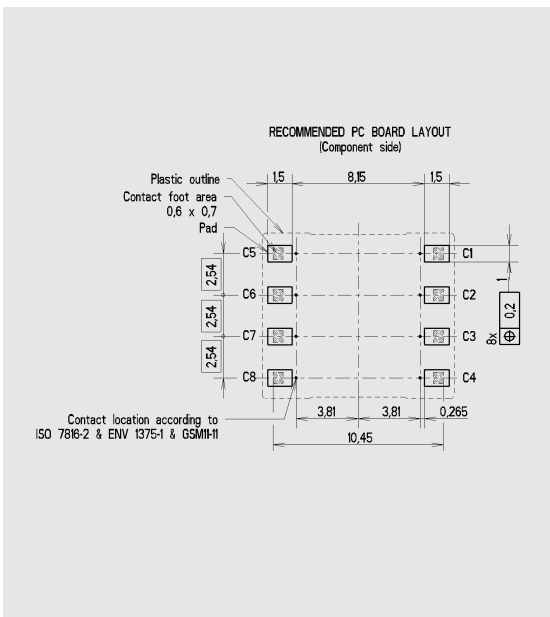

CCM04 MK III

2 x 4 contacts SMT IN

Height A	Height B	Inlay	Gold
2.4 mm	0.5 mm	CCM04-4137*	CCM04-5124*
2.5 mm	0.6 mm	CCM04-5109	CCM04-5125
2.65 mm	0.75 mm	CCM04-4138*	CCM04-5126*
2.9 mm	1.0 mm	CCM04-4139*	CCM04-5128*
3.15 mm	1.25 mm	CCM04-4140	CCM04-5135*

Height	Inlay	Gold
2.8 mm	CCM04-5108	CCM04-5127

Dimensional Drawings

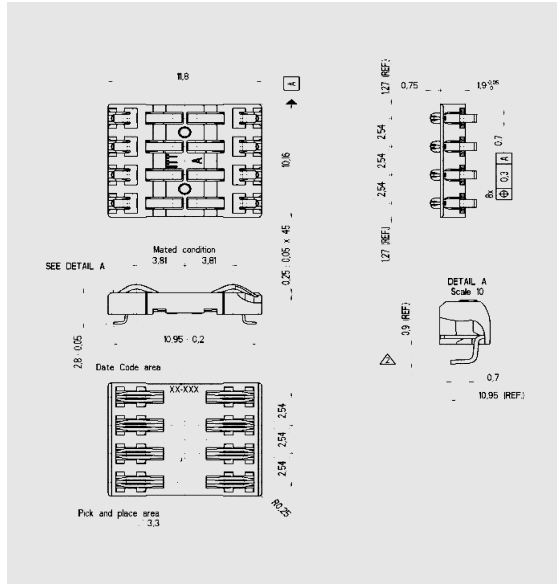
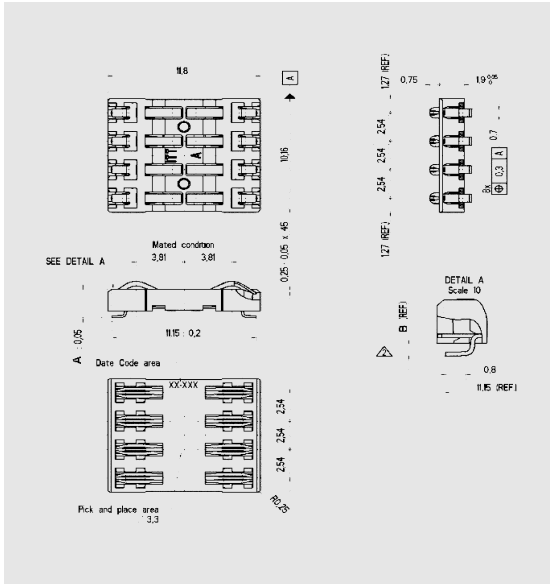

PCB Layout

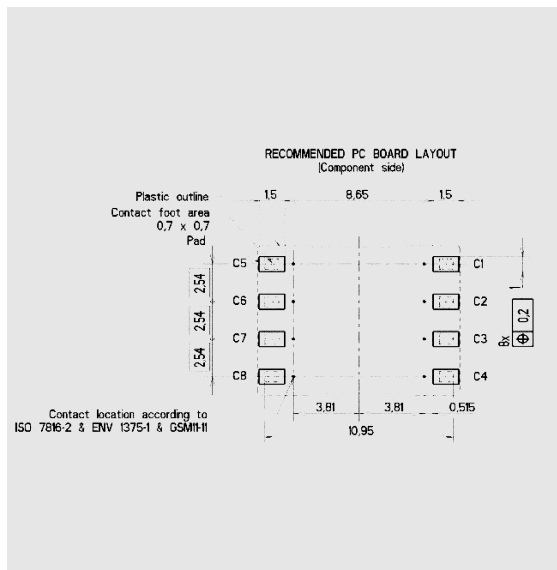
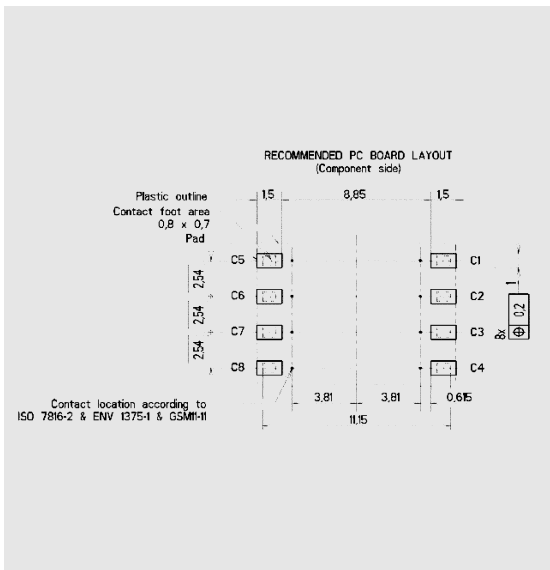

Note: * Versions on request

CCM04 MK III

2 x 4 contacts SMT OUT

Height A	Height B	Inlay	Gold
1.9 mm	0.1 mm	CCM04-4148	CCM04-5129
2.1 mm	0.2 mm	CCM04-4149	CCM04-5130
2.4 mm	0.5 mm	CCM04-4150	CCM04-5131
2.65 mm	0.75 mm	CCM04-4151	CCM04-5132
2.9 mm	1.0 mm	CCM04-4152*	CCM04-5133*

Dimensional Drawings

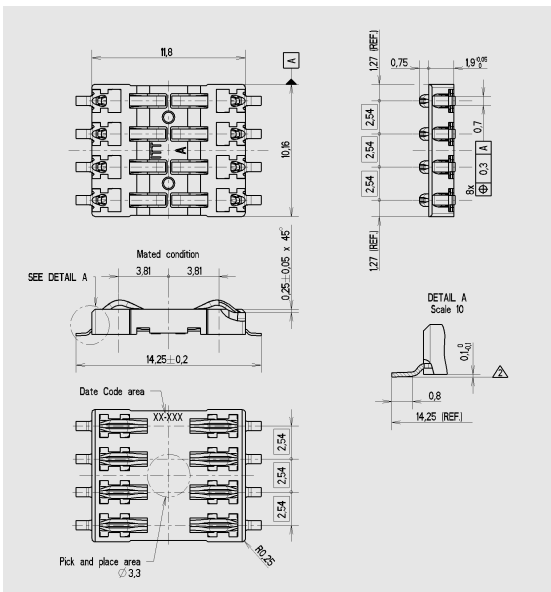

PCB Layout

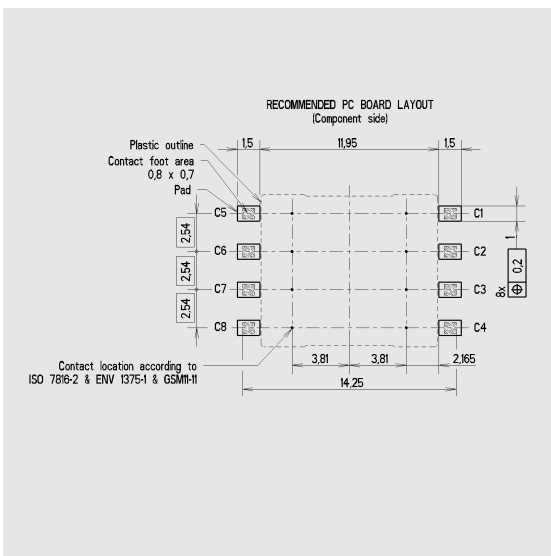

Note: * Versions on request



Cannon

Dimensions are shown in mm
Dimensions subject to change

www.ittcannon.com/ccm