

REFERENCE TABLE

TYPE NO.	DESCRIPTION	STOCK NO.	OUTLINE DRWG. NO.	CONNECTION DIAG. NO.
N74LS51N	Dual 2-Wide 2-Input AOI Gate	55673H	1	B39
N74LS54N	4-Wide 2-Input AOI Gate	55674F	1	B42
N74LS55N	2-Wide 4-Input AOI Gate	55675D	1	B218
N74LS73N	Dual J-K Master-Slave F/F	55676B	1	B52
N74LS74N	Dual D-Type Edge-Triggered F/F	55677X	1	B53
N74LS75N	Quad Bistable Latch	55678R	2	B54
N74LS76N	Dual J-K Master-Slave F/F	55679G	2	B55
N74LS78N	Dual J-K Negative Edge-Triggered F/F	55680X	2	B219
N74LS83AN	4-Bit Binary Full Adder	55681H	2	B58
N74LS85N	4-Bit Magnitude Comparator	55682F	2	B59
N74LS86N	Quad 2-Input Exclusive OR Gate	55683D	1	B60
N74LS90N	Decade Counter	55684B	1	B61
N74LS92N	Divide-By-Twelve Counter	55685X	1	B63
N74LS93N	4-Bit Binary Counter	55686R	1	B64
N74LS95BN	4-Bit Left-Right Shift Register	55687G	1	B66
N74LS96N	5-Bit Shift Register	55688E	2	B67
N74LS107N	Dual J-K Master-Slave F/F	55689C	1	B69
N74LS109N	Dual J-K Positive Edge-Triggered F/F	55690F	2	B70
N74LS112N	Dual J-K Negative Edge-Triggered F/F	55691D	2	B180
N74LS113N	Dual J-K Negative Edge-Triggered F/F	55692B	1	B181
N74LS114N	Dual J-K Negative Edge-Triggered F/F	55693X	1	B182
N74LS123N	Retriggerable Monostable Multivibrator	55694R	2	B74
N74LS125N	Quad Bus Buffer Gate w/Tri-state outputs	55695G	1	B75
N74LS126N	Quad Bus Buffer Gate w/Tri-state outputs	55696E	1	B76
N74LS132N	Quad Schmitt Trigger	55697C	1	B78
N74LS136N	Quad Exclusive OR O/C	55698A	1	B223
N74LS138N	3 to 1 of 8 Line Decoder/Demux	55699X	2	B186
N74LS139N	Dual 2 to 10 of 4 line Decoder/Demux	55700A	2	B187
N74LS145N	BCD-Decimal Decoder/Driver with o/c	55701X	2	B79
N74LS151N	8-Line to 1-Line Mux	55702H	2	B83
N74LS153N	Dual 4-Line to 1-Line Mux	55703F	2	B84
N74LS155N	Dual 2-Line to 4-Line Decoder/Demux	55704D	2	B86
N74LS157N	Quad 2-Input Data Selector (non-inv.)	55705B	2	B88
N74LS158N	Quad 2-Input Data Selector (inv.)	55706X	2	B89
N74LS160N	Synchronous 4-Bit Decade Counter	55707R	2	B90
N74LS161N	Synchronous 4-Bit Binary Counter	55708G	2	B91
N74LS162N	Synchronous 4-Bit Decade Counter	55709E	2	B92
N74LS163N	Synchronous 4-Bit Binary Counter	55710H	2	B93
N74LS164N	8-Bit Parallel Out Serial Shift Register	55711F	1	B94
N74LS170N	4 x 4 Register File	55712D	2	B97
N74LS173N	Quad D-Type F/F (Tri-State) (8T10)	55713B	2	B98
N74LS174N	Hex D-Type F/F with Clear	55714X	2	B99
N74LS175N	Quad D-Type Edge-Triggered F/F	55715R	2	B100
N74LS181N	4-Bit A/U	55716G	3	B106
N74LS190N	Synchronous UP/Down Counter (BCD)	55717E	2	B108
N74LS191N	Synchronous Up/Down Counter (Binary)	55718C	2	B109
N74LS192N	Synchronous Decade Up/Down Counter	55719A	2	B110
N74LS193N	Synchronous 4-Bit Binary Up/Down Counter	55720D	2	B111
N74LS194N	4-Bit Bidirectional Universal Shift Reg.	55721B	2	B112
N74LS195AN	4-Bit Parallel-Access Shift Reg.	55722X	2	B113
N74LS196N	Presetable Decade Counter/Latch (8290)	55723R	1	B114
N74LS197N	Presetable Binary Counter/Latch (8291)	55724G	1	B115
N74LS221N	Dual Monostable Multivibrator	55725E	2	B118
N74LS240N	Octal Inverter—3 State	55726C	2	B226
N74LS241N	Octal Buffer—2 State	55727A	2	B227
N74LS242N		55728X	1	B228
N74LS243N		55729H	2	B229
N74LS244N		55730X	4	B230
N74LS251N	Data Selector/Mux with 3-State outputs	55731R	2	B193
N74LS253N	Dual 4-Line to 1-Line Data Selector/Mux	55732G	2	B194
N74LS257N	Quad 2-Line to 1-Line Data Selector/Mux	55733E	2	B195
N74LS258N	Quad 2-Line to 1-Line Data Selector/Mux	55734C	2	B196

PLEASE QUOTE STOCK NO.
AND MANUFACTURERS PART NO. WHEN ORDERING



Signetics

Outline Drawings



III GEMINI

FOR CURRENT PRICES PHONE
HARLOW (0279) 29644



PLEASE QUOTE STOCK NO.
AND MANUFACTURERS PART NO. WHEN ORDERING

ITT GEMINI

Signetics

Outline Drawings

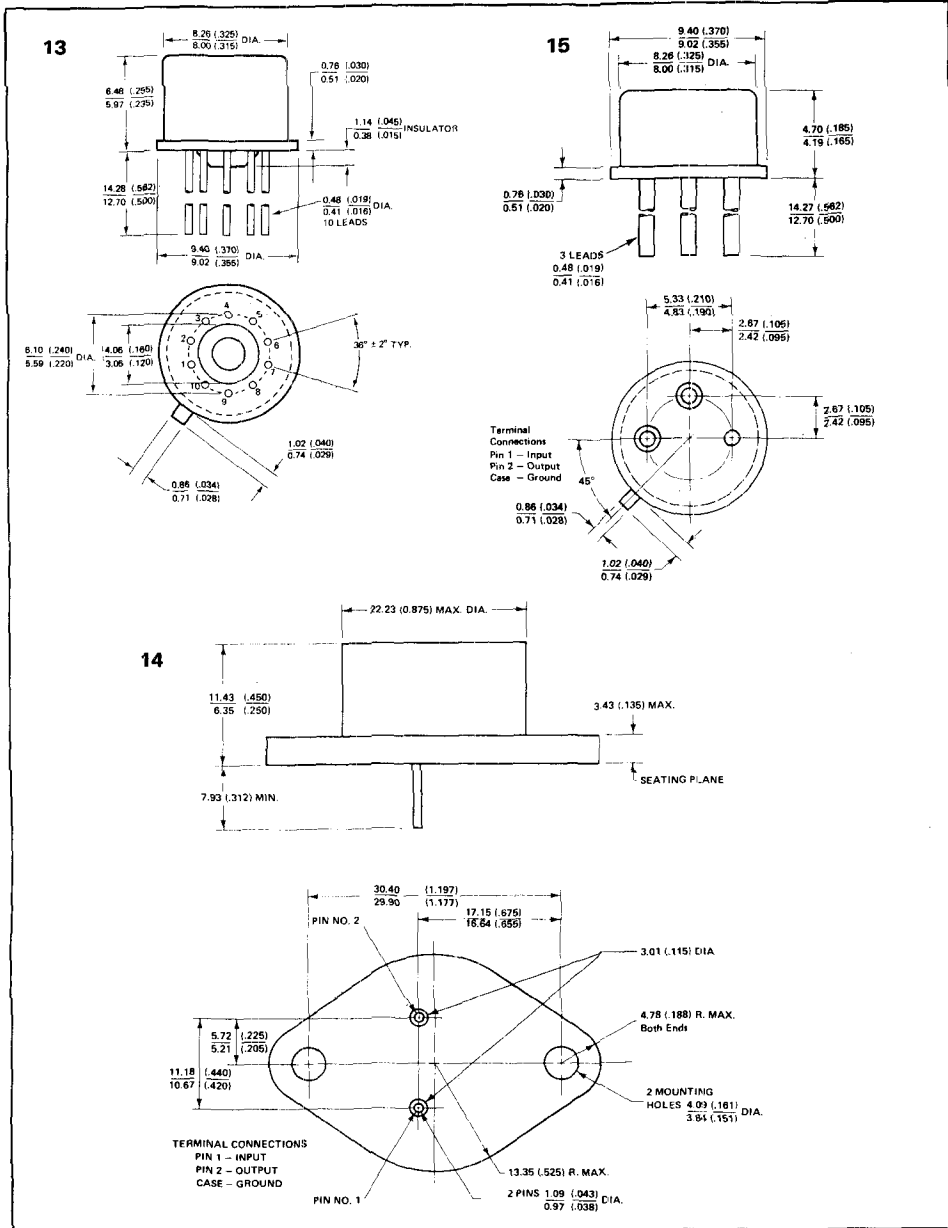

ITT GEMINI

FOR CURRENT PRICES PHONE
HARLOW (0279) 29644

16

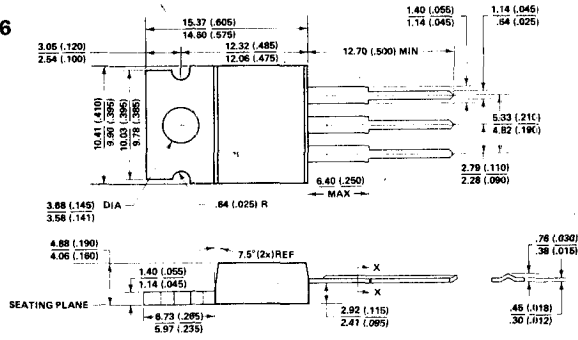

17



19



PLEASE QUOTE STOCK NO.
AND MANUFACTURER PART NO. WHEN ORDERING

TTT GEMINI

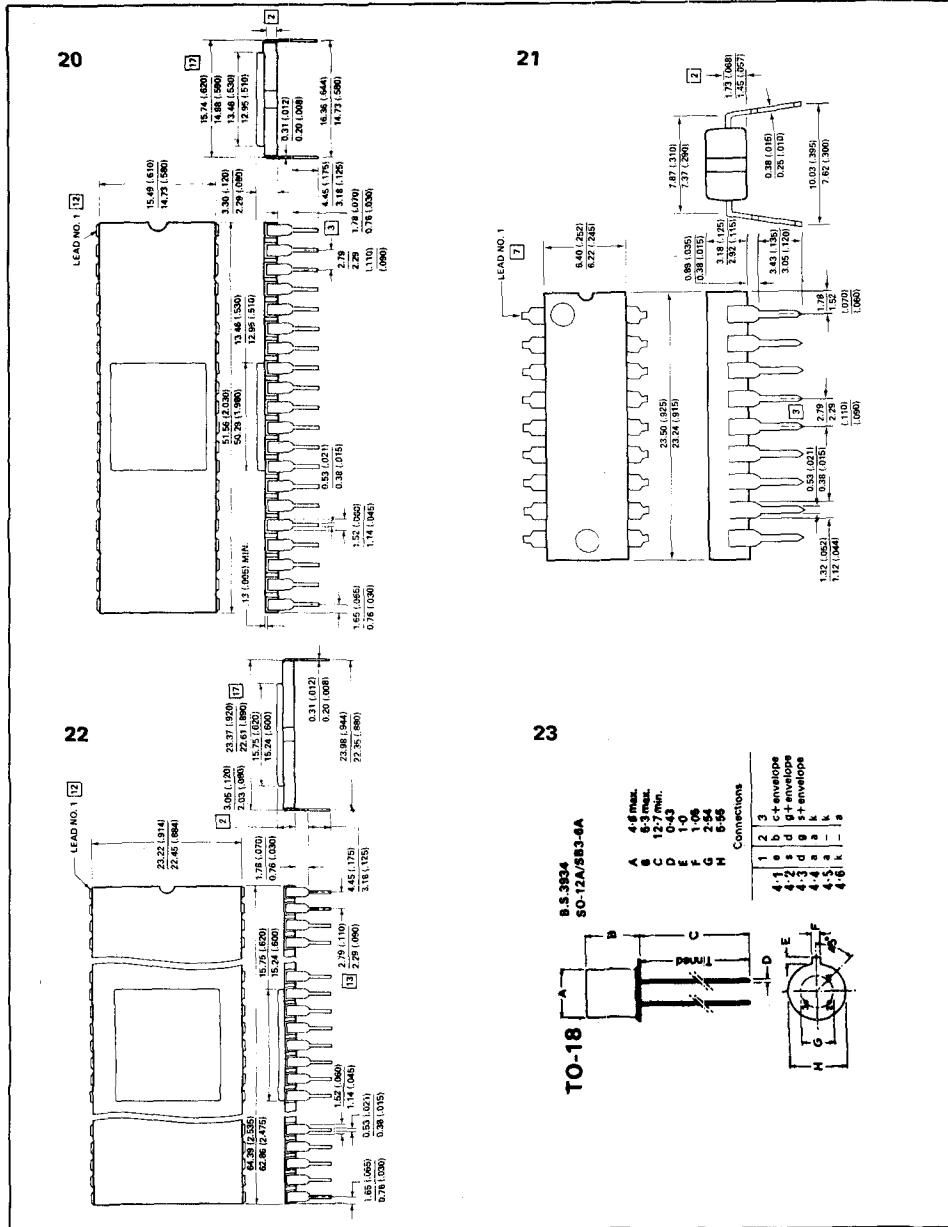

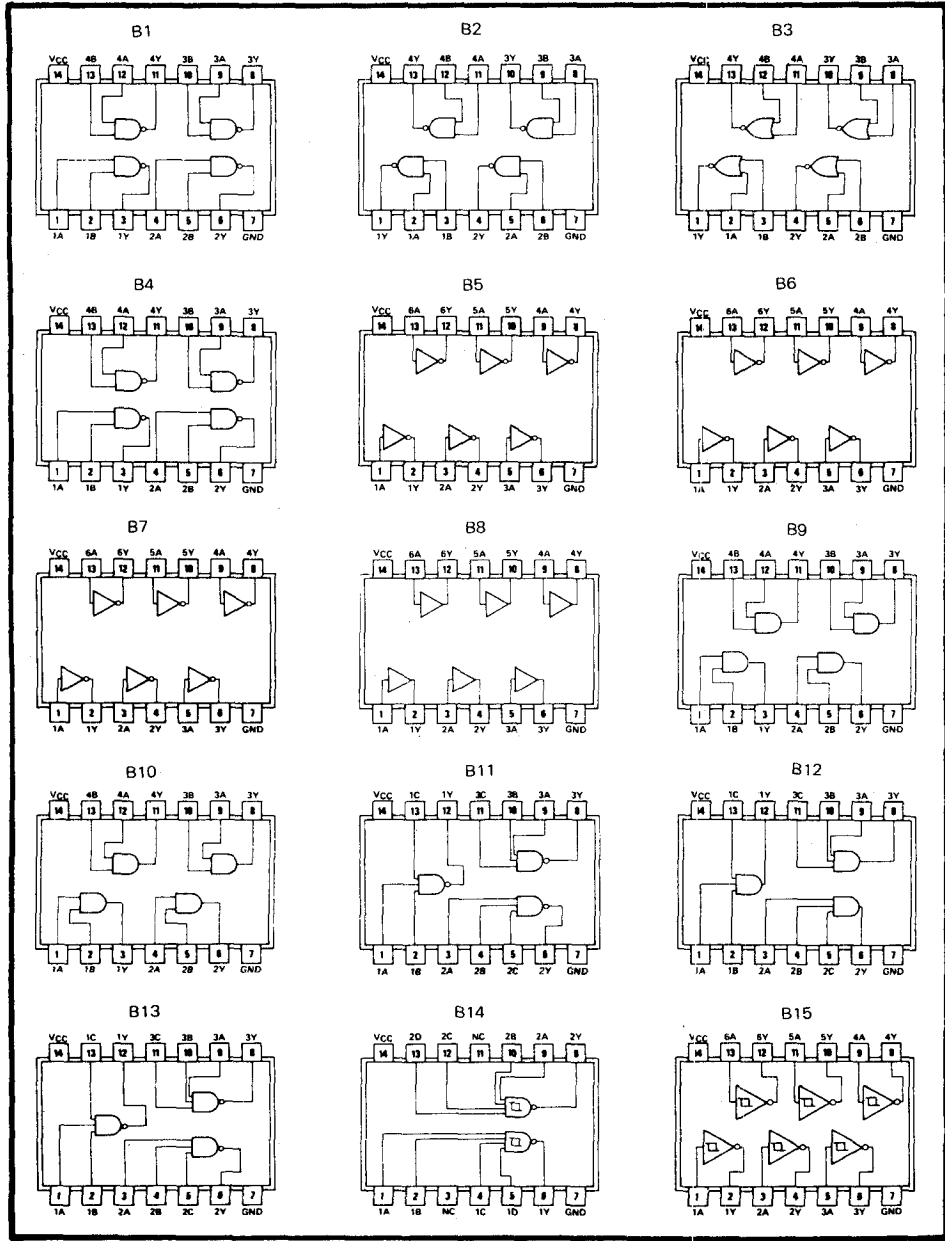

PLEASE QUOTE STOCK NO.
AND MANUFACTURERS PART NO. WHEN ORDERING



Signetics

Connection Diagram

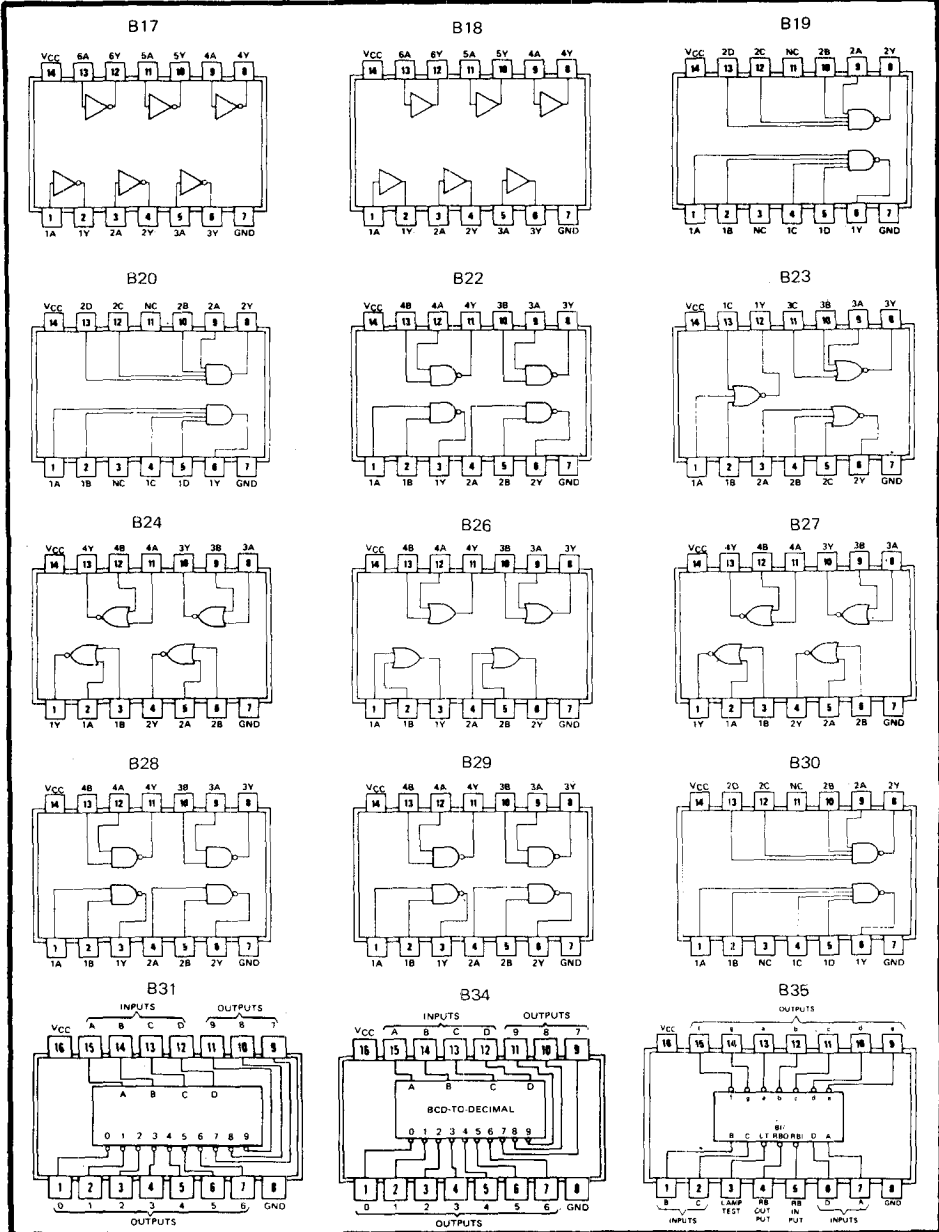

TTL GEMINI

FOR CURRENT PRICES PHONE
HARLOW (0279) 29644

Signetics

Connection Diagram

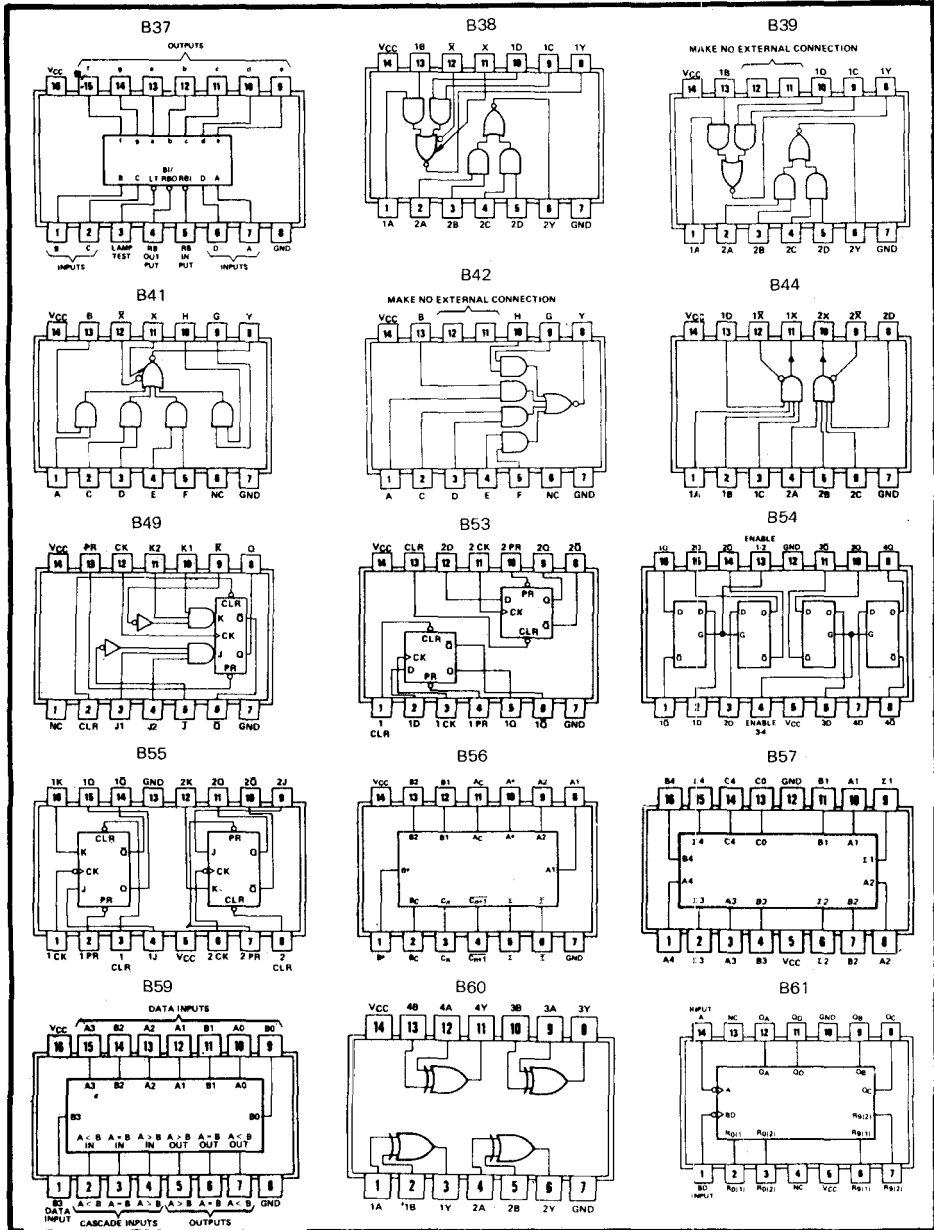

PLEASE QUOTE STOCK NO.
AND MANUFACTURERS PART NO. WHEN ORDERING



Signetics

Connection Diagram

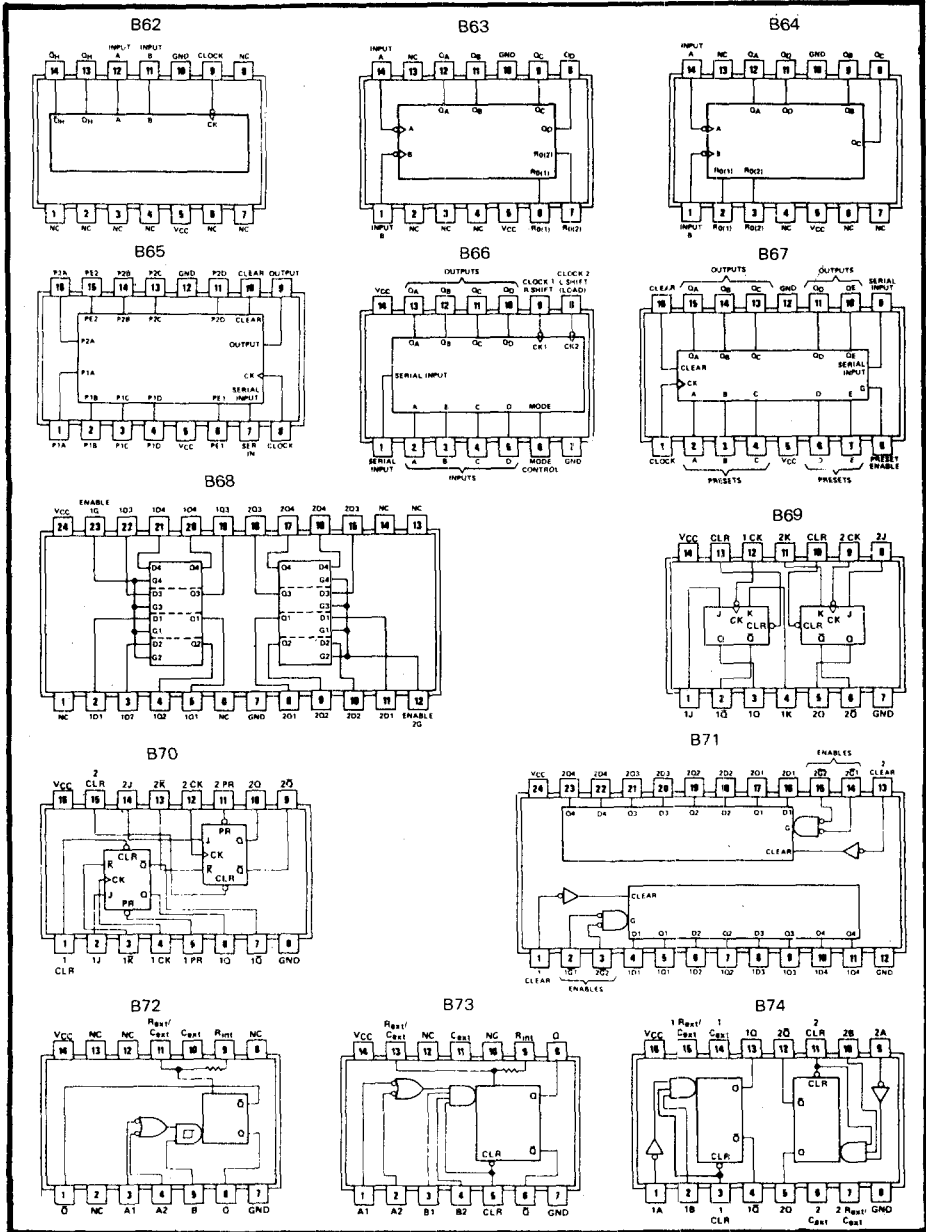

FOR CURRENT PRICES PHONE
HARLOW (0279) 29644

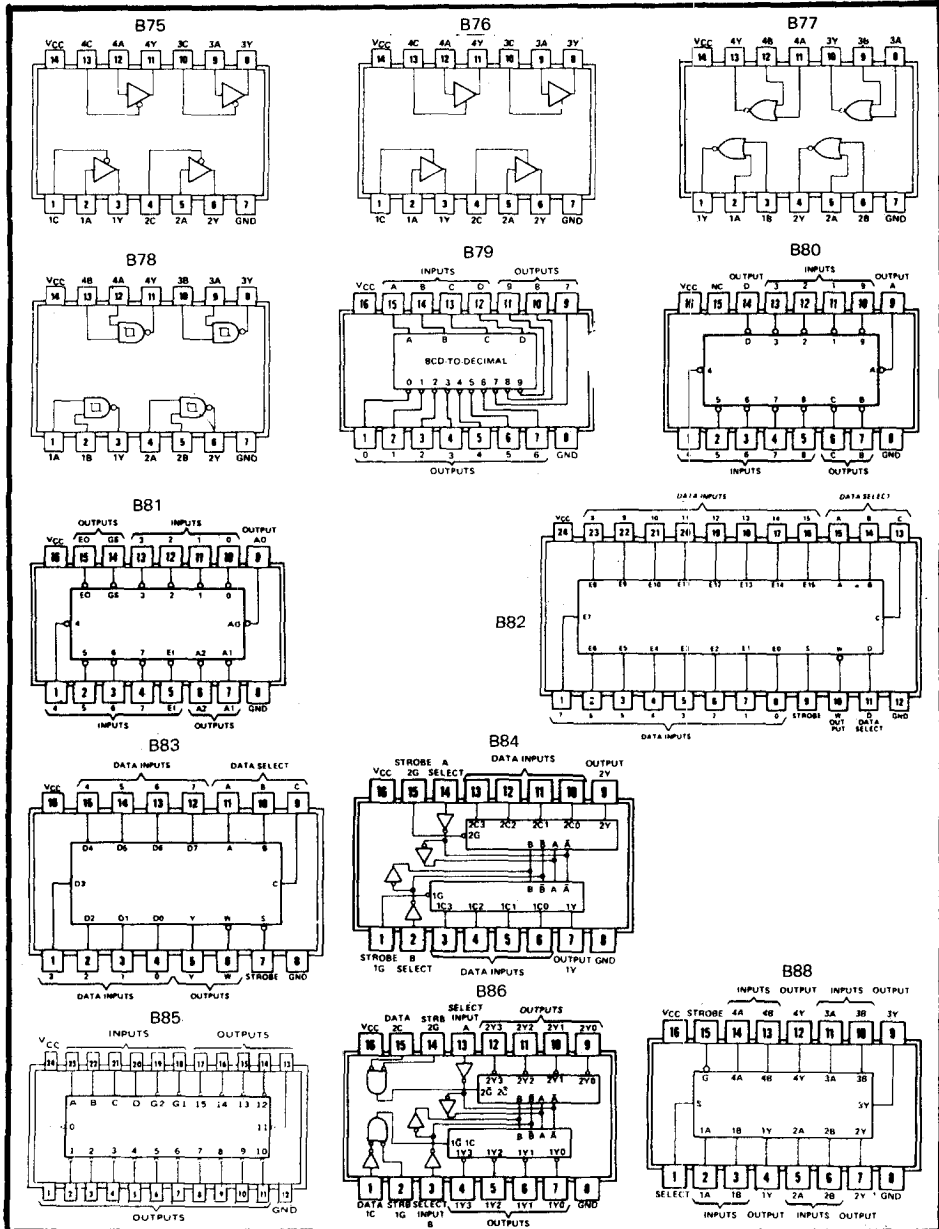

PLEASE QUOTE STOCK NO.
AND MANUFACTURERS PART NO. WHEN ORDERING

III GEMINI

Signetics

Connection Diagram

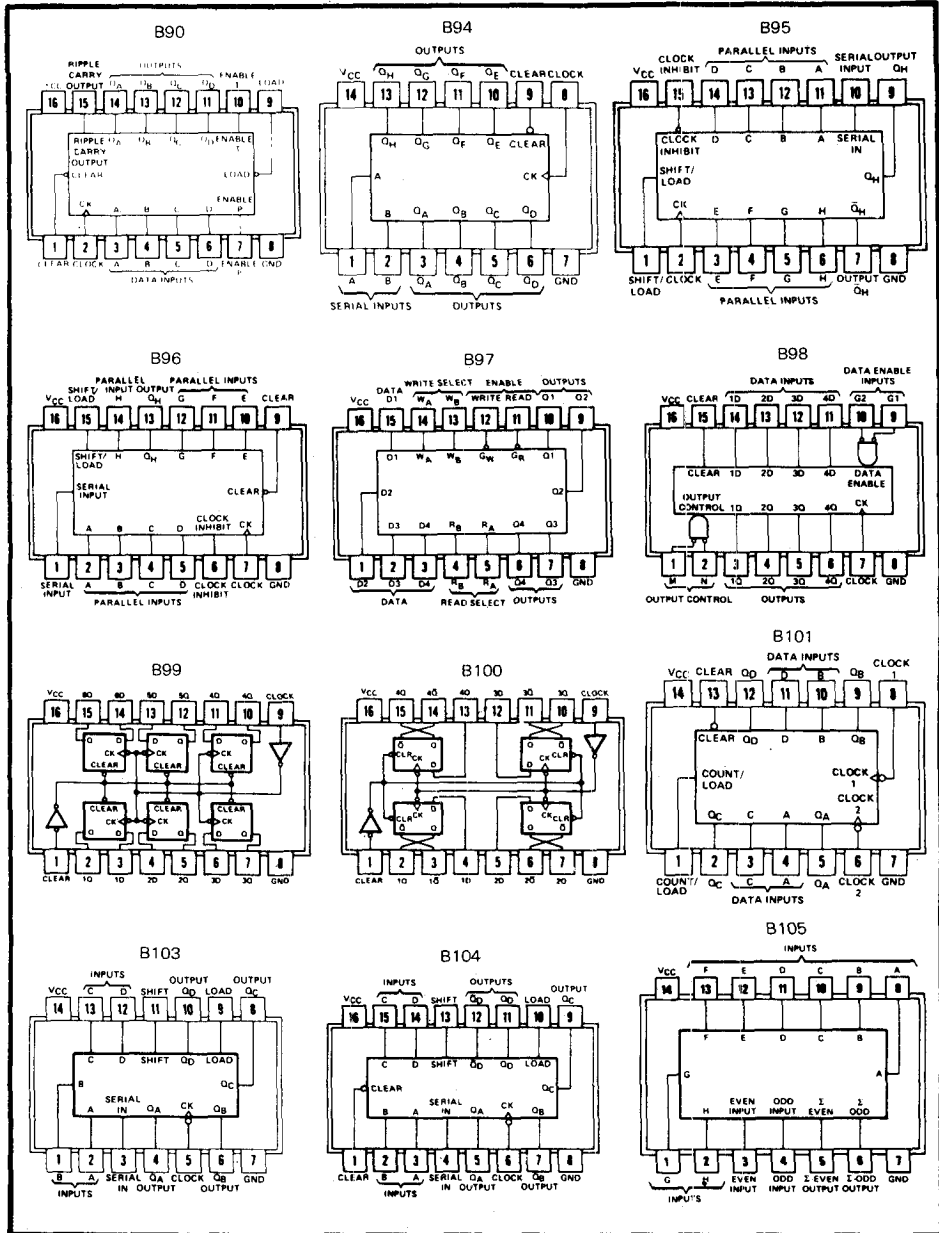

GEMINI

FOR CURRENT PRICES PHONE HARLOW (0279) 29644

Signetics

Connection Diagram

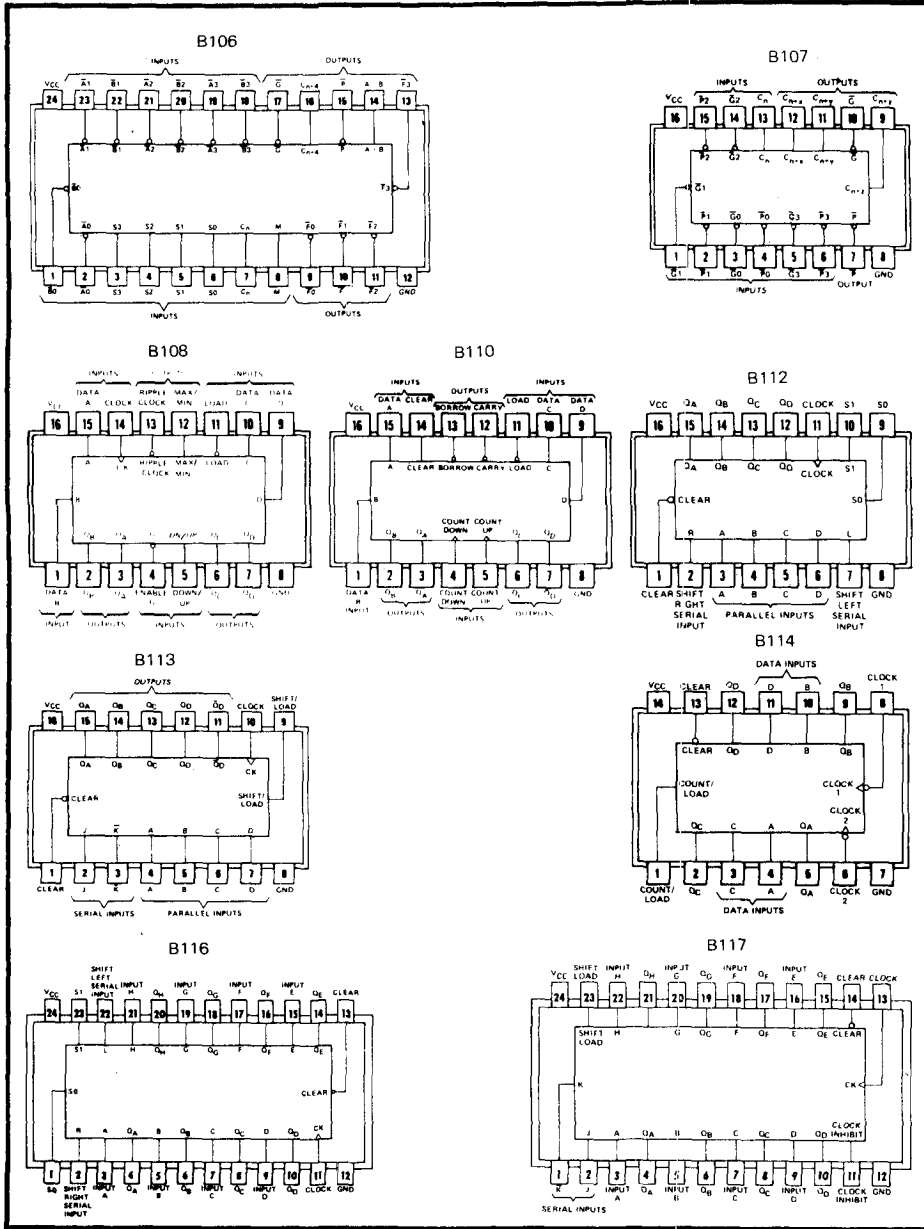

PLEASE QUOTE STOCK NO.
AND MANUFACTURERS PART NO. WHEN ORDERING



Signetics

Connection Diagram

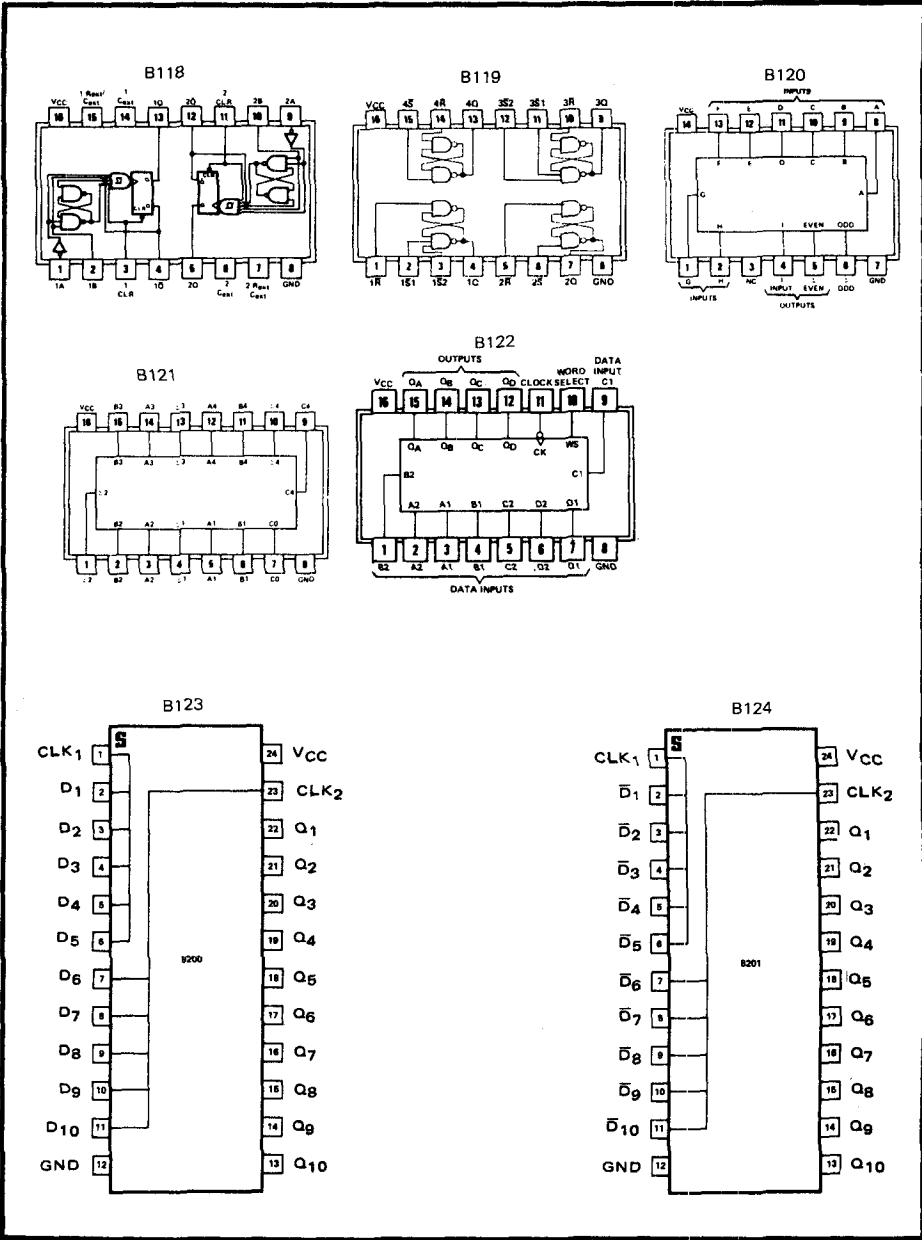

ITT GEMINI

FOR CURRENT PRICES PHONE HARLOW (0279) 29644

Signetics

Connection Diagram

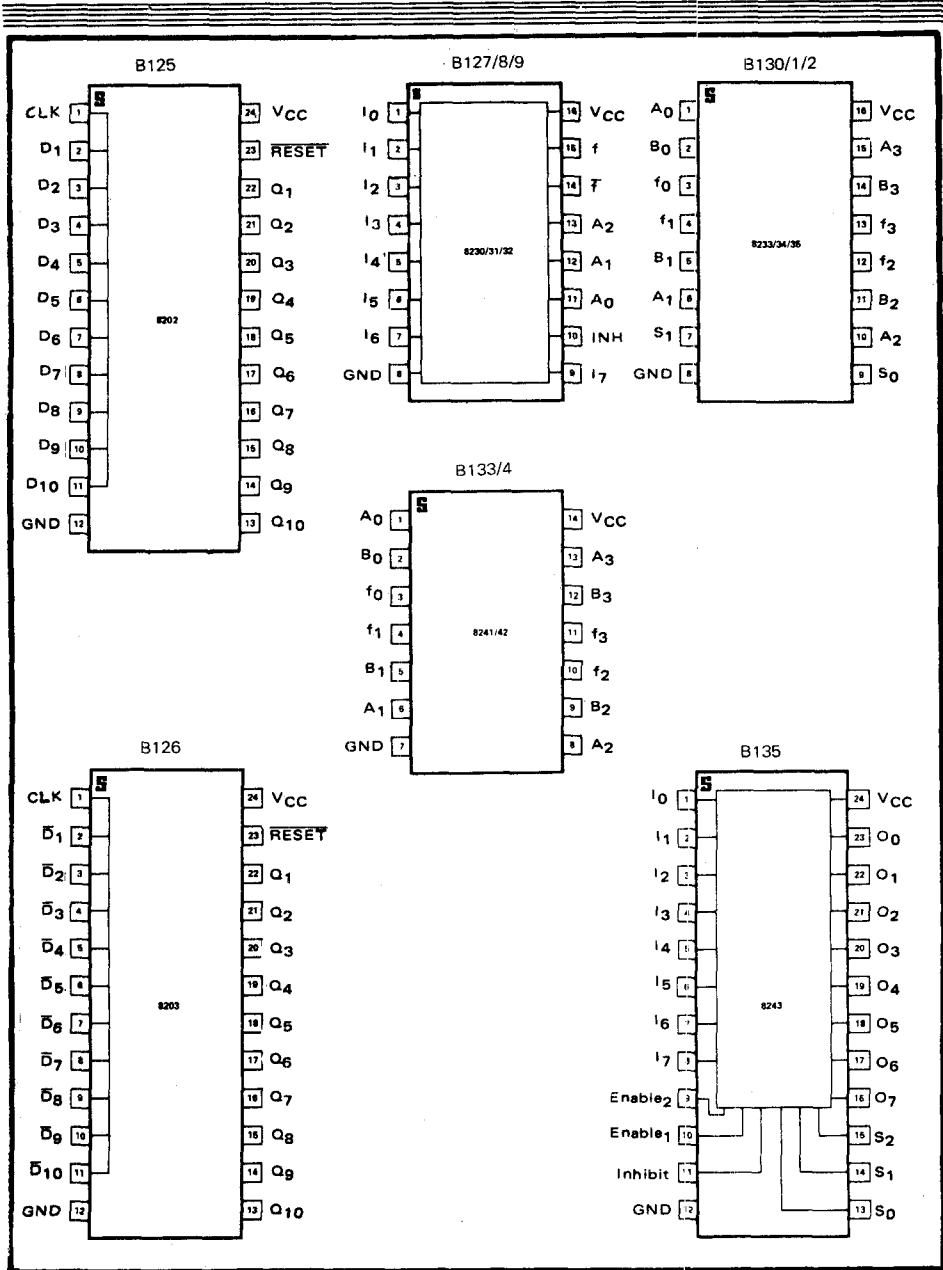

PLEASE QUOTE STOCK NO.
AND MANUFACTURERS PART NO. WHEN ORDERING



Signetics

Connection Diagram

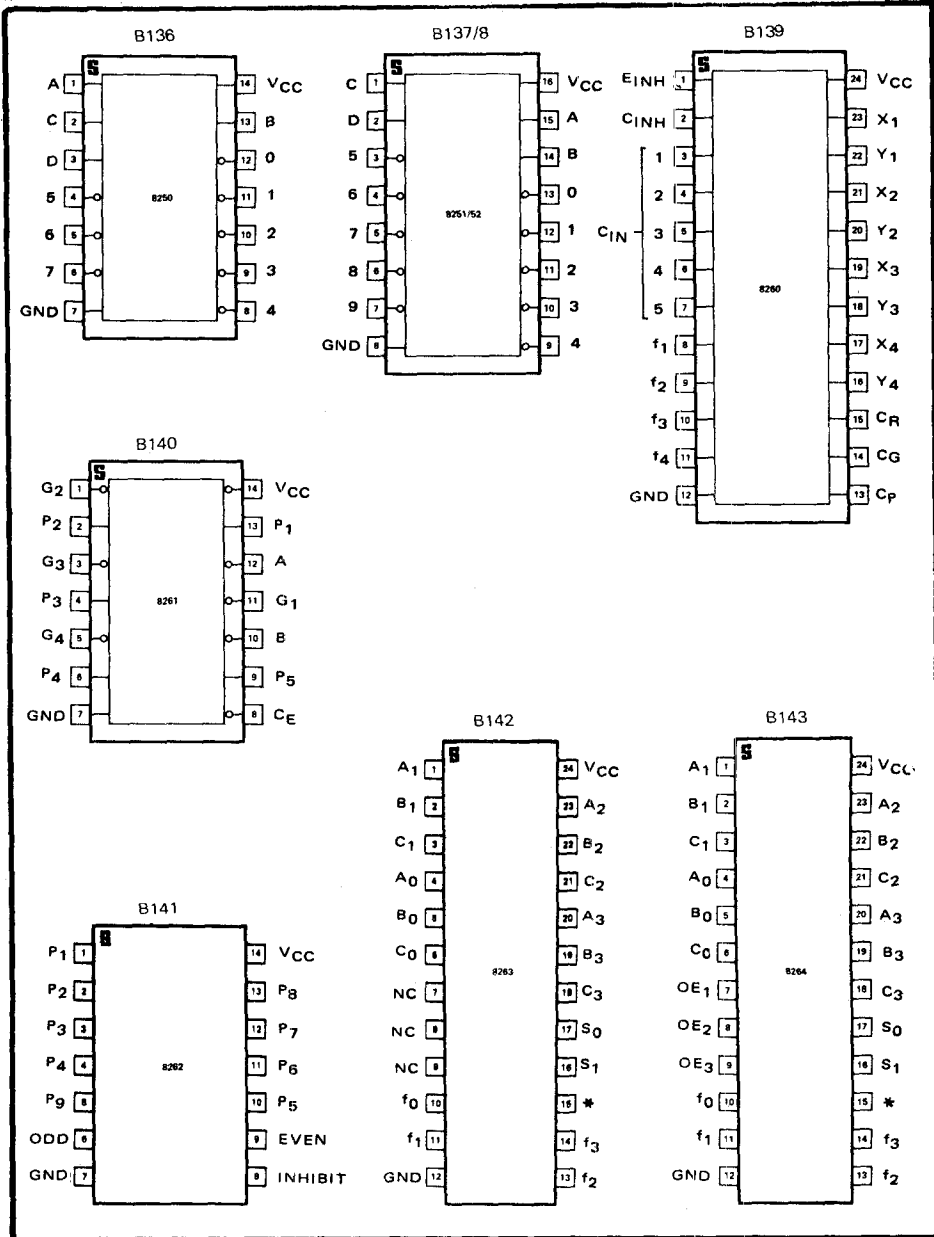

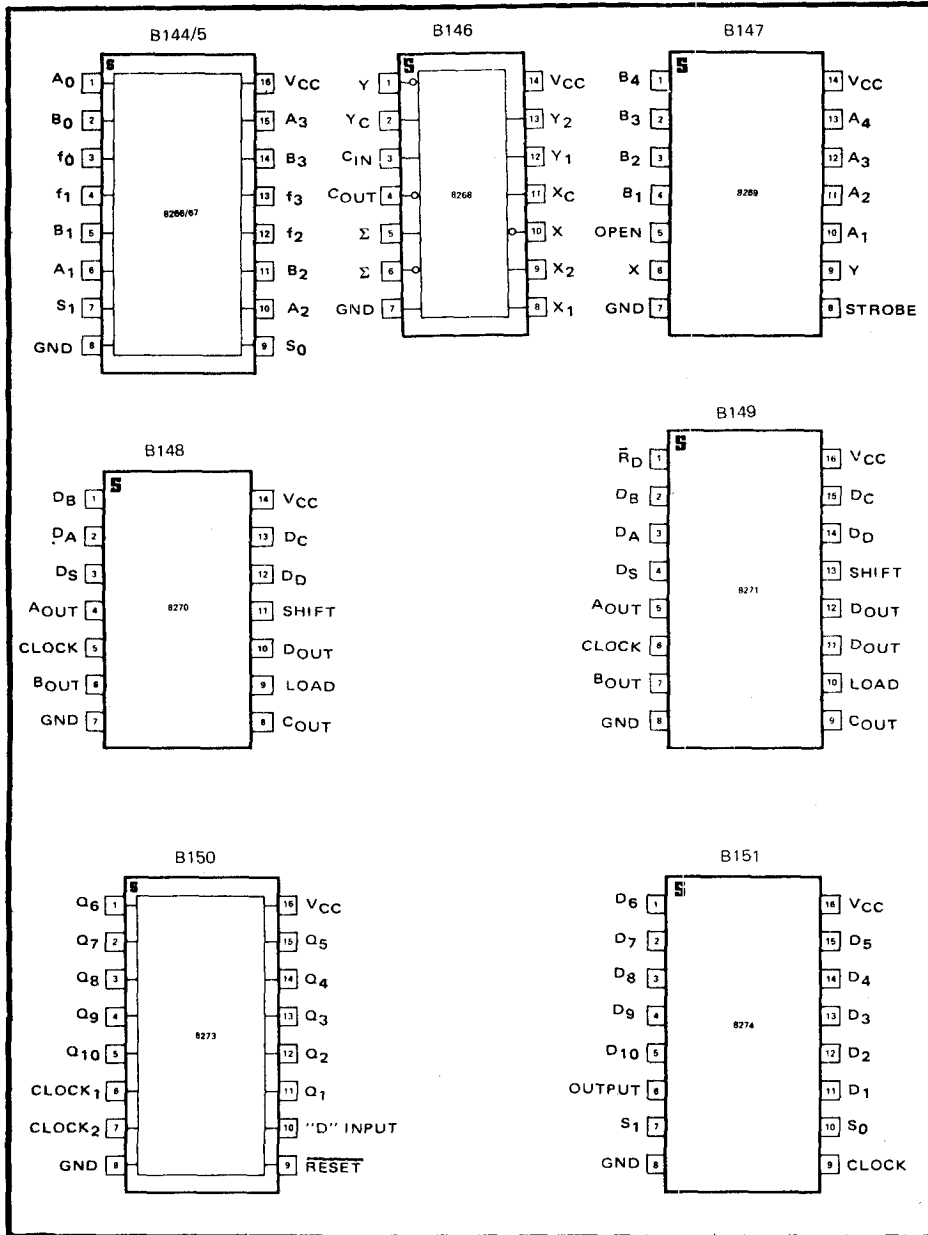

PLEASE QUOTE STOCK NO.
AND MANUFACTURERS PART NO. WHEN ORDERING



Signetics

Connection Diagram

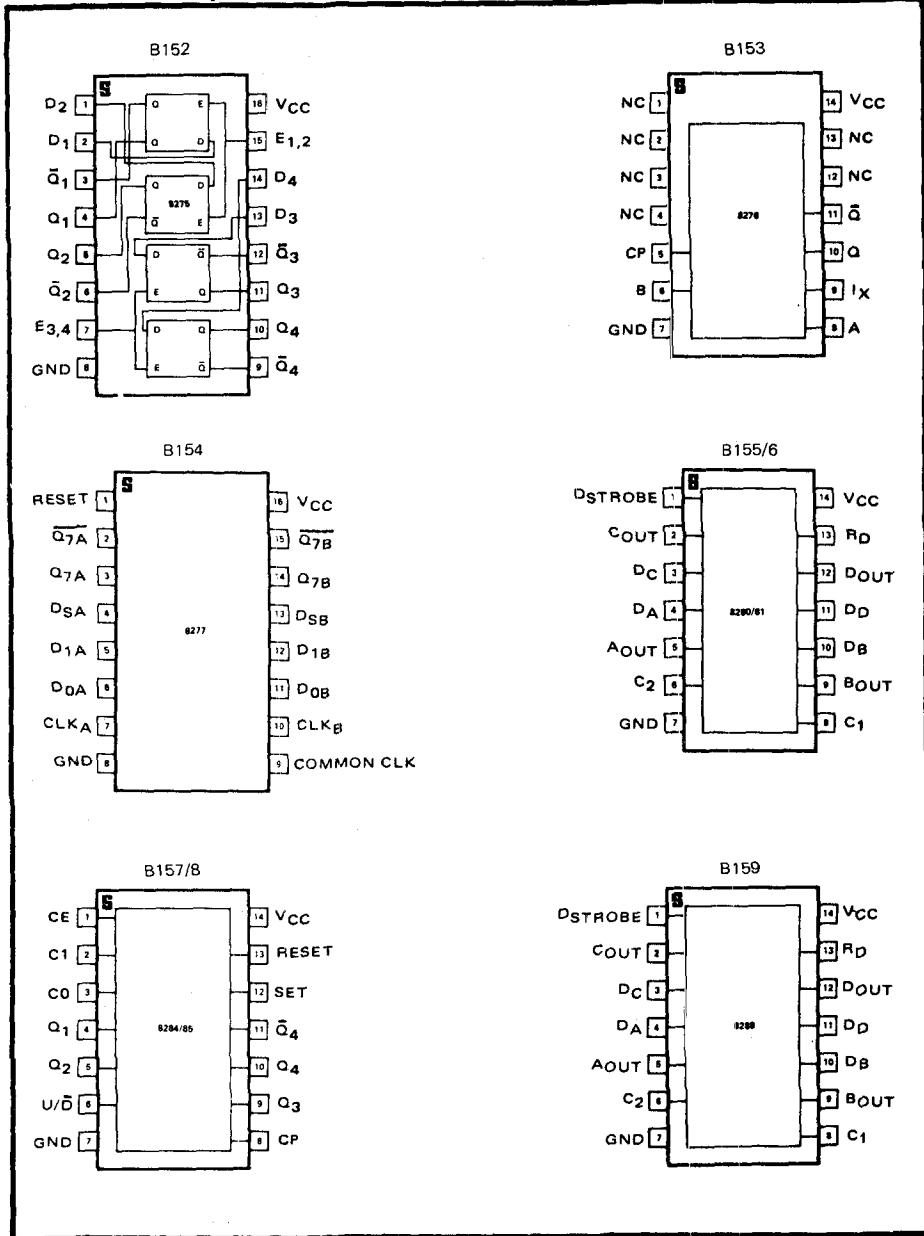

ITT GEMINI

FOR CURRENT PRICES PHONE HARLOW (0279) 29644

Signetics

Connection Diagram

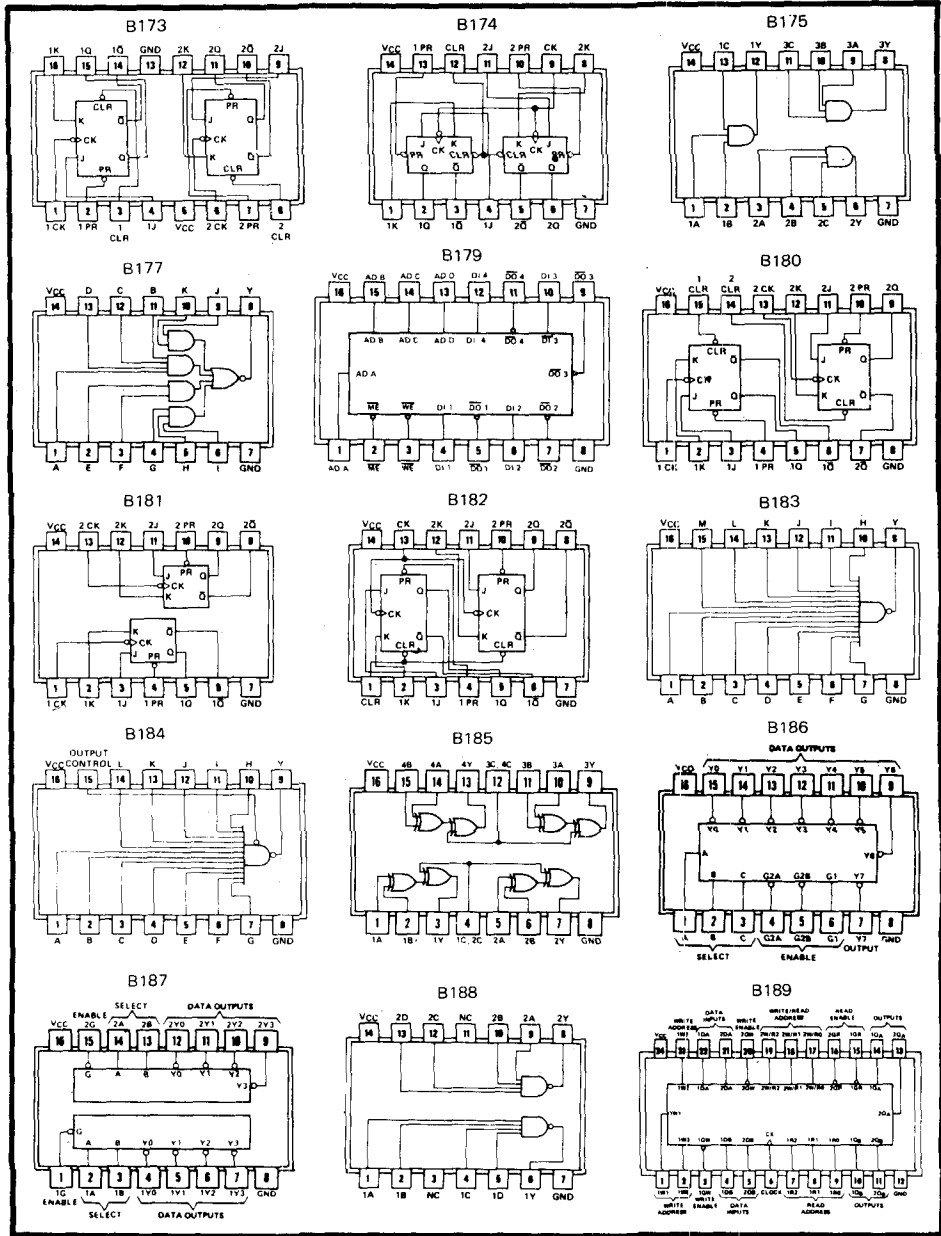

FOR CURRENT PRICES PHONE
HARLOW (0279) 29644

Signetics

Connection Diagram

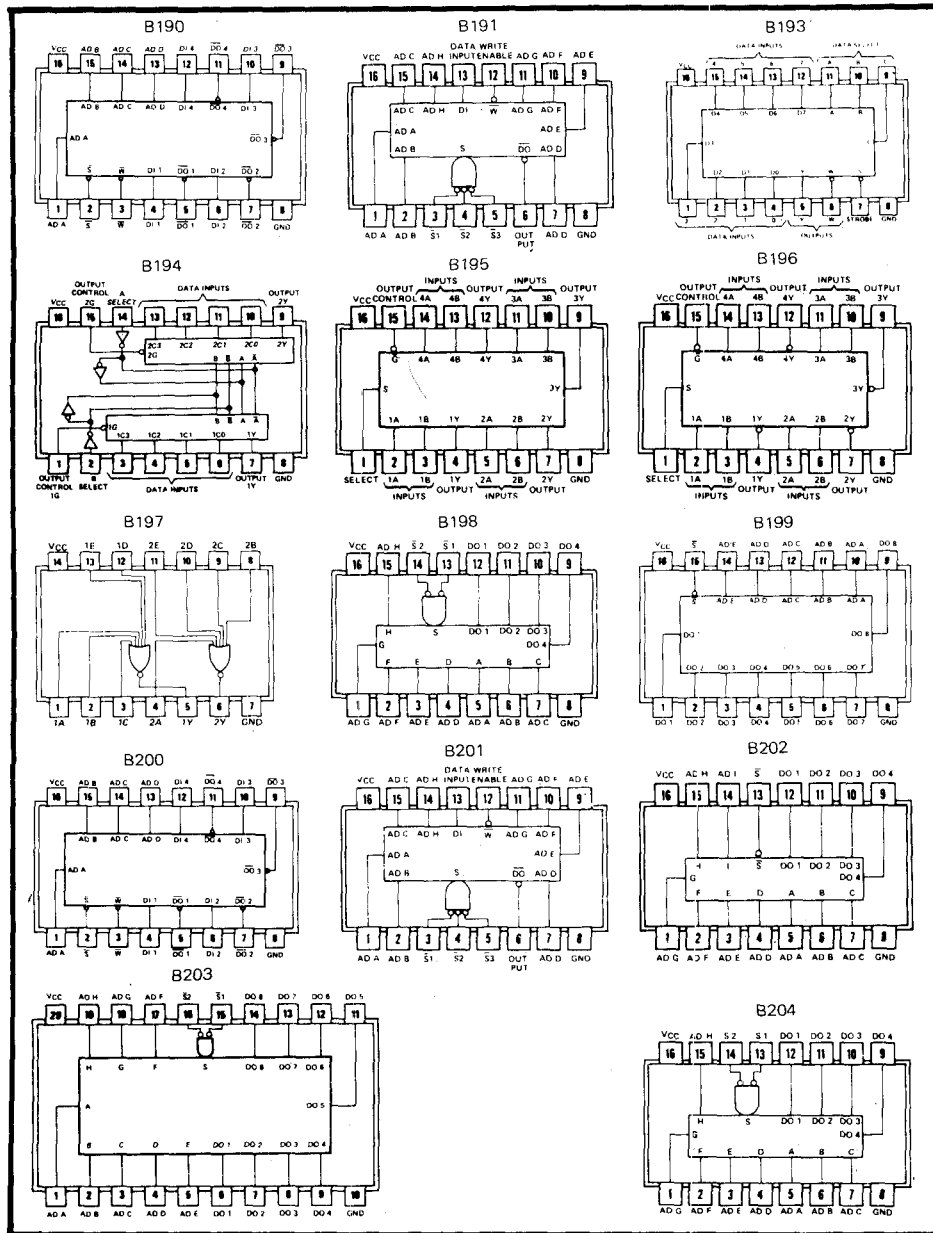

PLEASE QUOTE STOCK NO.
AND MANUFACTURERS PART NO. WHEN ORDERING

ITT GEMINI

Signetics

Connection Diagram

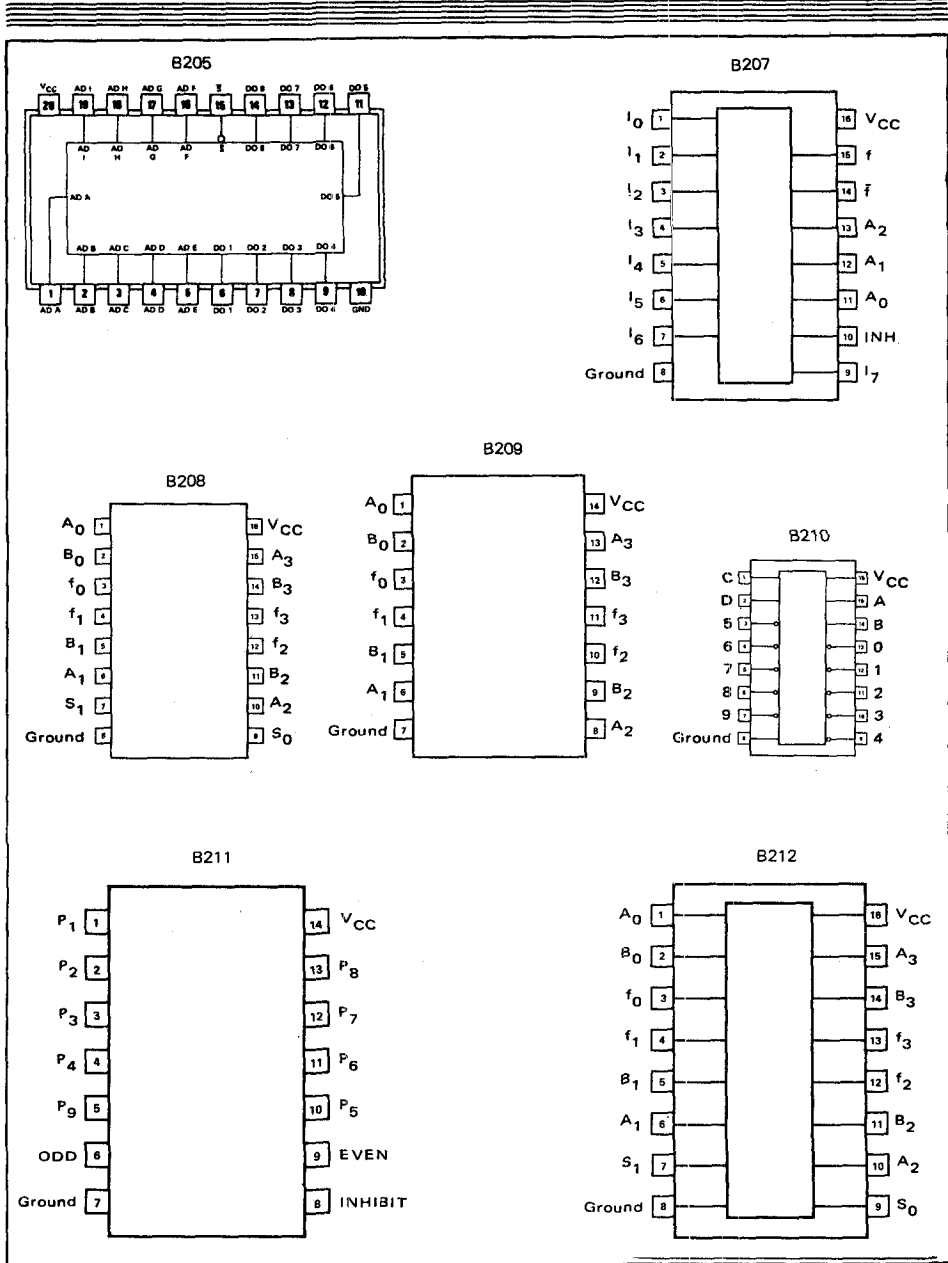

FOR CURRENT PRICES PHONE HARLOW (0279) 29644

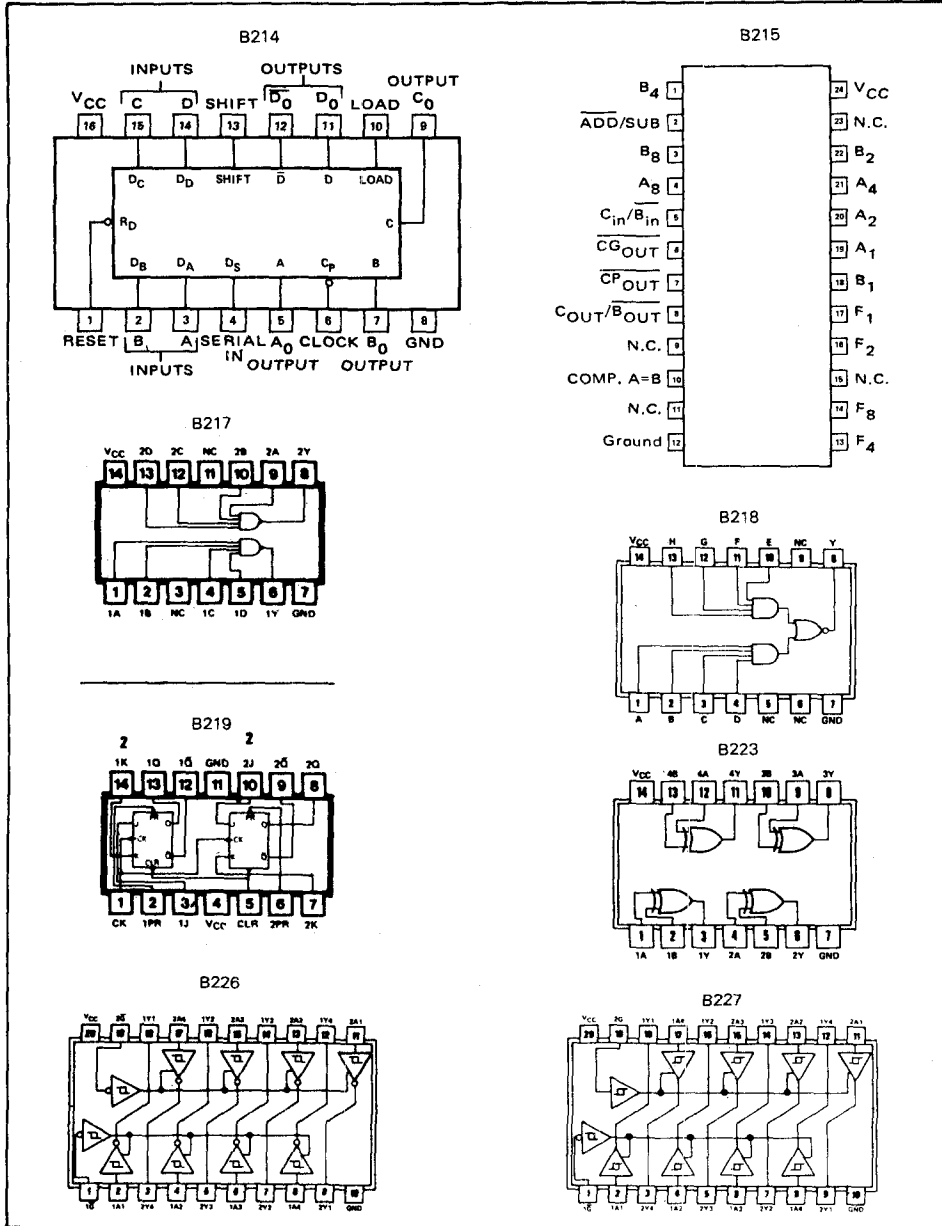

PLEASE QUOTE STOCK NO.
AND MANUFACTURERS PART NO. WHEN ORDERING



Signetics

Connection Diagram

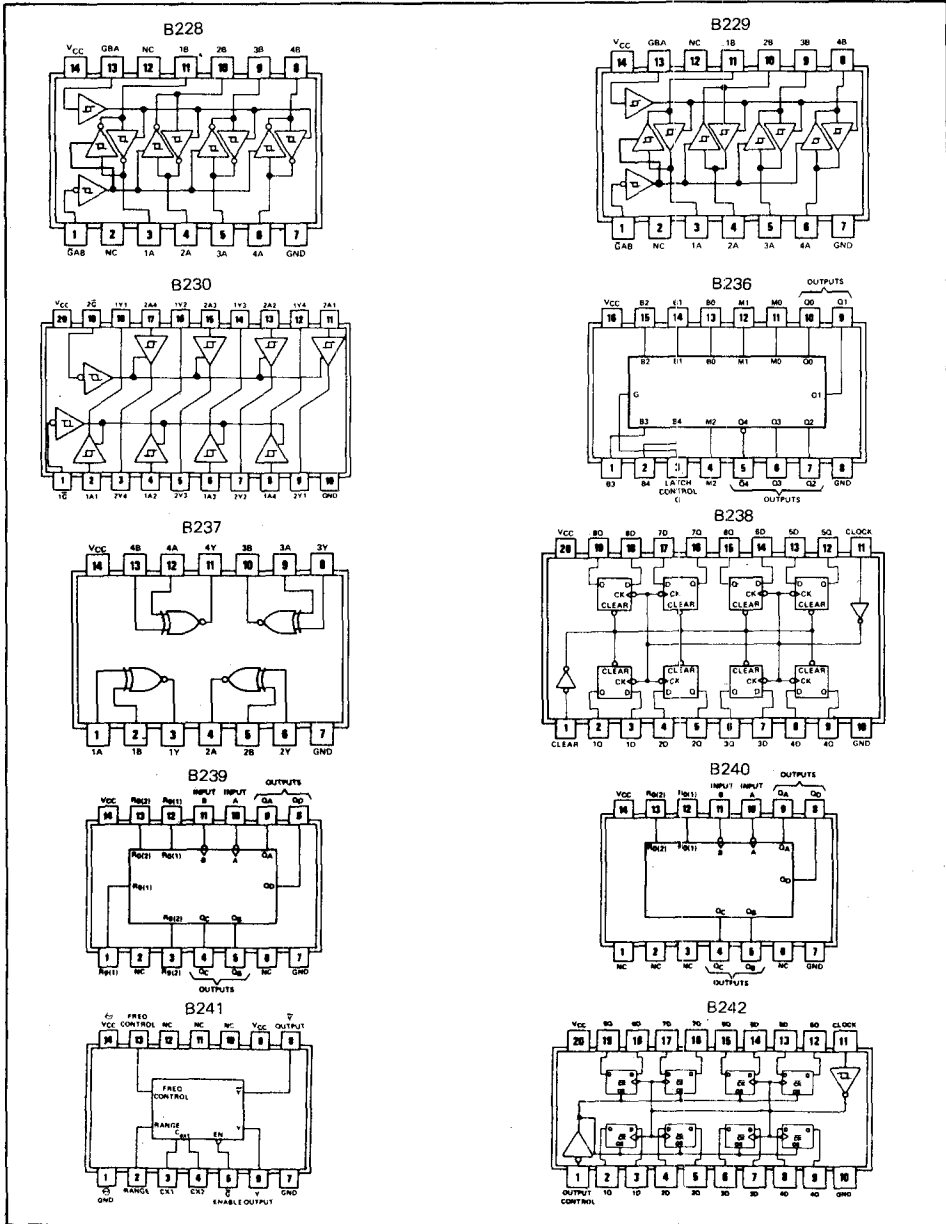

LIT GEMINI

FOR CURRENT PRICES PHONE HARLOW (0279) 29644

Signetics

Connection Diagram

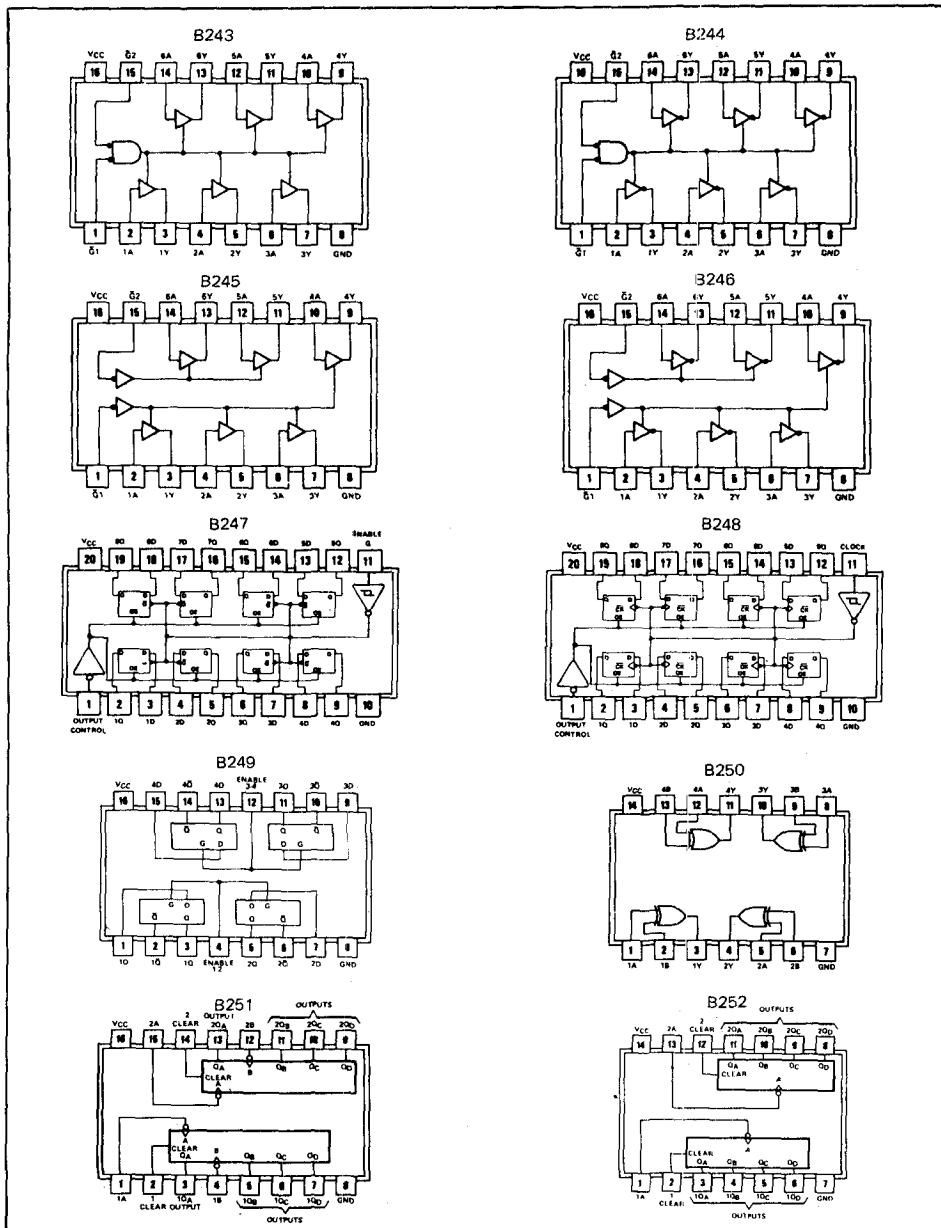

PLEASE QUOTE STOCK NO.
AND MANUFACTURERS PART NO. WHEN ORDERING



Signetics

Connection Diagram

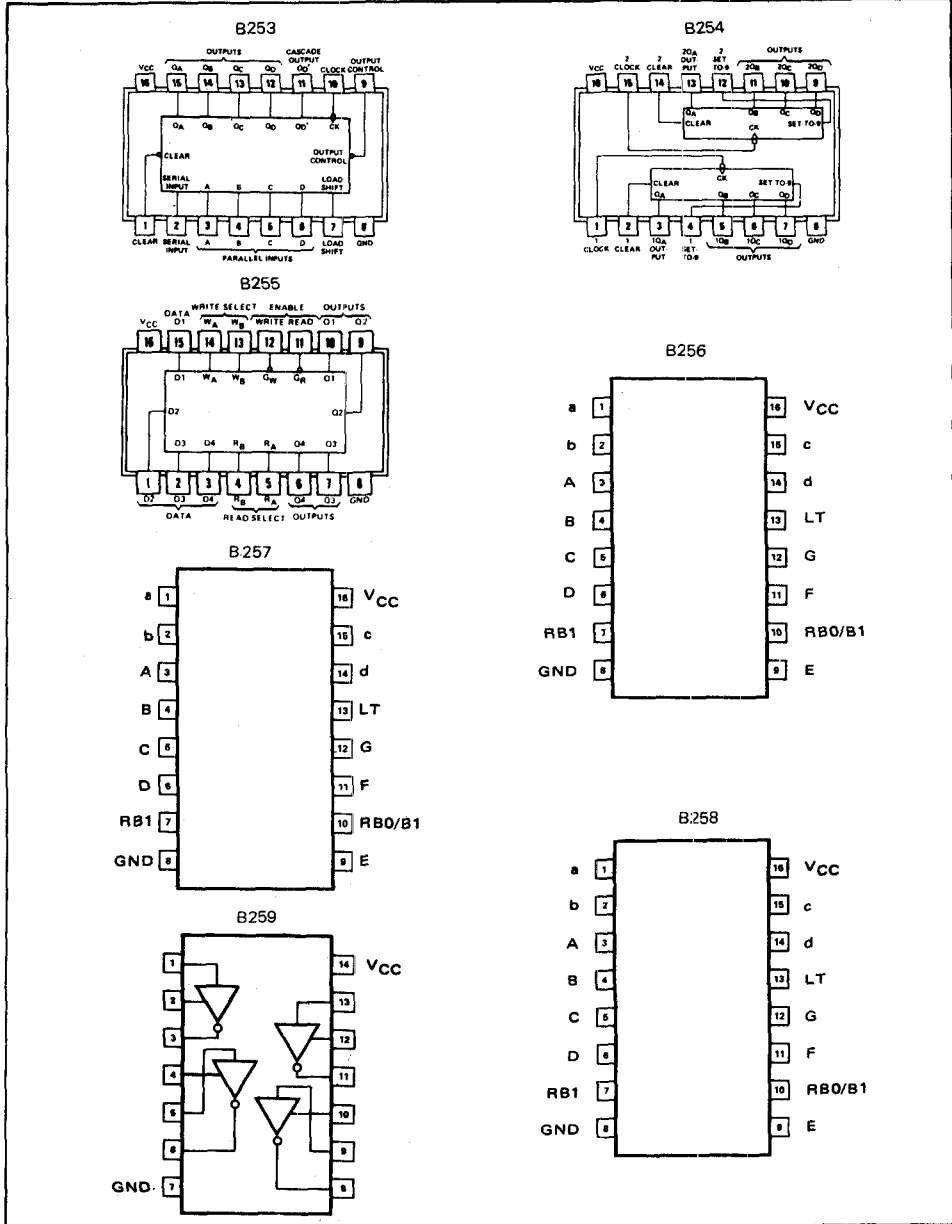

FOR CURRENT PRICES PHONE HARLOW (0279) 29644