



Is Now Part of



ON Semiconductor®

To learn more about ON Semiconductor, please visit our website at
www.onsemi.com

Please note: As part of the Fairchild Semiconductor integration, some of the Fairchild orderable part numbers will need to change in order to meet ON Semiconductor's system requirements. Since the ON Semiconductor product management systems do not have the ability to manage part nomenclature that utilizes an underscore (_), the underscore (_) in the Fairchild part numbers will be changed to a dash (-). This document may contain device numbers with an underscore (_). Please check the ON Semiconductor website to verify the updated device numbers. The most current and up-to-date ordering information can be found at www.onsemi.com. Please email any questions regarding the system integration to Fairchild_questions@onsemi.com.

ON Semiconductor and the ON Semiconductor logo are trademarks of Semiconductor Components Industries, LLC dba ON Semiconductor or its subsidiaries in the United States and/or other countries. ON Semiconductor owns the rights to a number of patents, trademarks, copyrights, trade secrets, and other intellectual property. A listing of ON Semiconductor's product/patent coverage may be accessed at www.onsemi.com/site/pdf/Patent-Marking.pdf. ON Semiconductor reserves the right to make changes without further notice to any products herein. ON Semiconductor makes no warranty, representation or guarantee regarding the suitability of its products for any particular purpose, nor does ON Semiconductor assume any liability arising out of the application or use of any product or circuit, and specifically disclaims any and all liability, including without limitation special, consequential or incidental damages. Buyer is responsible for its products and applications using ON Semiconductor products, including compliance with all laws, regulations and safety requirements or standards, regardless of any support or applications information provided by ON Semiconductor. "Typical" parameters which may be provided in ON Semiconductor data sheets and/or specifications can and do vary in different applications and actual performance may vary over time. All operating parameters, including "Typicals" must be validated for each customer application by customer's technical experts. ON Semiconductor does not convey any license under its patent rights nor the rights of others. ON Semiconductor products are not designed, intended, or authorized for use as a critical component in life support systems or any FDA Class 3 medical devices or medical devices with a same or similar classification in a foreign jurisdiction or any devices intended for implantation in the human body. Should Buyer purchase or use ON Semiconductor products for any such unintended or unauthorized application, Buyer shall indemnify and hold ON Semiconductor and its officers, employees, subsidiaries, affiliates, and distributors harmless against all claims, costs, damages, and expenses, and reasonable attorney fees arising out of, directly or indirectly, any claim of personal injury or death associated with such unintended or unauthorized use, even if such claim alleges that ON Semiconductor was negligent regarding the design or manufacture of the part. ON Semiconductor is an Equal Opportunity/Affirmative Action Employer. This literature is subject to all applicable copyright laws and is not for resale in any manner.

KA5Q-SERIES

KA5Q0765RT/KA5Q12656RT/KA5Q1265RF/

KA5Q1565RF

Fairchild Power Switch(FPS)

Features

- Quasi Resonant Converter Controller
- Internal Burst Mode Controller for Stand-by Mode
- Pulse by Pulse Current Limiting
- Over Current Latch Protection
- Over Voltage Protection (Vsync: Min. 11V)
- Internal Thermal Shutdown Function
- Under Voltage Lockout
- Internal High Voltage Sense FET
- Auto-Restart Mode

Description

The Fairchild Power Switch(FPS) product family is specially designed for an off-line SMPS with minimal external components. The Fairchild Power Switch(FPS) consist of high voltage power SenseFET and current mode PWM controller IC. PWM controller features integrated fixed oscillator, under voltage lock out, leading edge blanking, optimized gate turn-on/turn-off driver, thermal shut down protection, over voltage protection, temperature compensated precision current sources for loop compensation and fault protection circuit. compared to discrete MOSFET and controller or RCC switching converter solution, a Fairchild Power Switch(FPS) can reduce total component count, design size, and weight and at the same time increase & efficiency, productivity, and system reliability. It has a basic platform well suited for cost-effective design in quasi resonant converter as C-TV power supply.

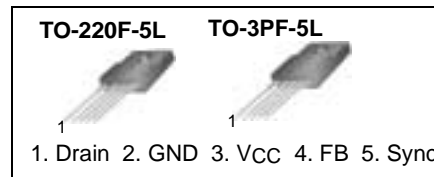

Internal Block Diagram

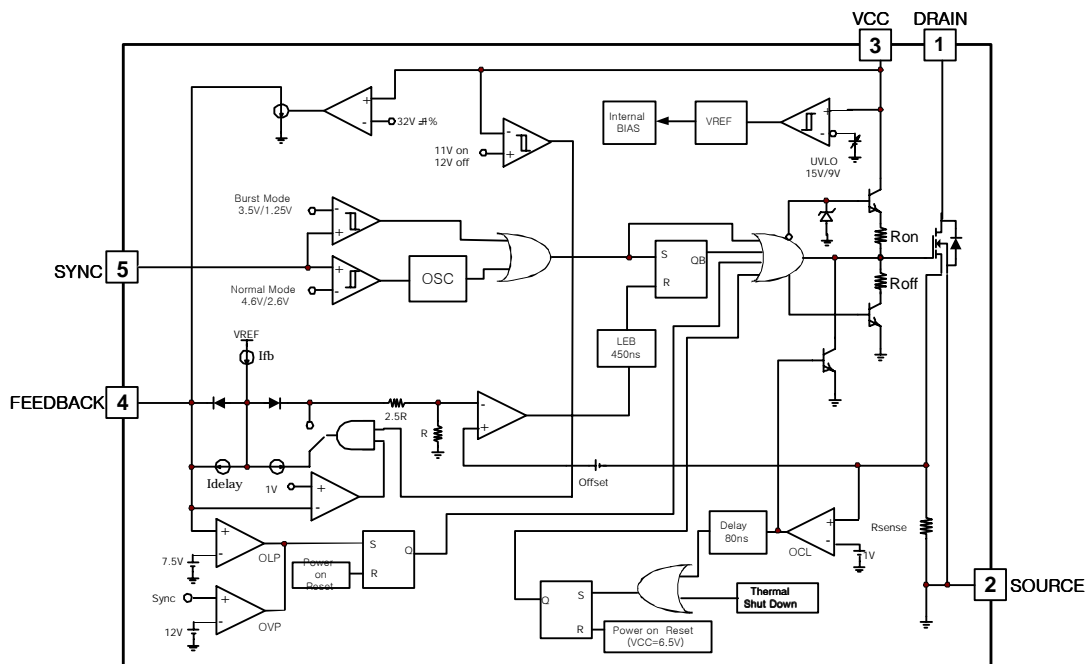

Absolute Maximum Ratings

(Ta=25°C, unless otherwise specified)

Characteristic	Symbol	Value	Unit
KA5Q0765RT			
Drain-source Voltage	V _{DSS}	650	V
Drain-Gate Voltage(R _{GS} =1MΩ)	V _{DGR}	650	V
Gate-Source(GND) Voltage	V _{GS}	±30	V
Drain Current Pulsed ⁽¹⁾	I _{DM}	15	ADC
Continuous Drain Current (T _c = 25°C)	I _D	3.8	ADC
Continuous Drain Current (T _c = 100°C)	I _D	2.4	ADC
Single Pulsed Avalanch Current ⁽³⁾ (Energy ⁽²⁾)	I _{AS} (EAS)	20(570)	A(mJ)
Maximum Supply Voltage	V _{CC,MAX}	40	V
Input Voltage Range	V _{FB}	-0.3 to V _{CC}	V
	V _{Sync}	-0.3 to 13	V
Total Power Dissipation	P _D	47	W
Operating Junction Temperature.	T _J	+160	°C
Operating Ambient Temperature.	T _A	-25 to +85	°C
Storage Temperature Range.	T _{STG}	-55 to +150	°C
Thermal Resistance	R _{thjc}	2.7	°C/W
ESD Capability, HBM Model (All pins)		2.0	kV
ESD Capability, Machine Model (All pins)		300	V
KA5Q12656RT			
Drain-source Voltage	V _{DSS}	650	V
Drain-Gate Voltage(R _{GS} =1MΩ)	V _{DGR}	650	V
Gate-Source(GND) Voltage	V _{GS}	±30	V
Drain Current Pulsed ⁽¹⁾	I _{DM}	21	ADC
Continuous Drain Current (T _c = 25°C)	I _D	5.3	ADC
Continuous Drain Current (T _c = 100°C)	I _D	3.4	ADC
Single Pulsed Avalanch Current(Energy ⁽²⁾)	I _{AS} (EAS)	30(950)	A(mJ)
Maximum Supply Voltage	V _{CC,MAX}	40	V
Input Voltage Range	V _{FB}	-0.3 to V _{CC}	V
	V _{Sync}	-0.3 to 13	V
Total Power Dissipation	P _D	55	W
Operating Junction Temperature.	T _J	+160	°C
Operating Ambient Temperature.	T _A	-25 to +85	°C
Storage Temperature Range.	T _{STG}	-55 to +150	°C
Thermal Resistance	R _{thjc}	2.7	°C/W
ESD Capability, HBM Model (All pins)		2.0	kV
ESD Capability, Machine Model (All pins)		300	V

Absolute Maximum Ratings (Continued)

(Ta=25°C, unless otherwise specified)

Characteristic	Symbol	Value	Unit
KA5Q1265RF			
Drain-source Voltage	V _{DSS}	650	V
Drain-Gate Voltage(R _{GS} =1MΩ)	V _{DGR}	650	V
Gate-Source(GND) Voltage	V _{GS}	±30	V
Drain Current Pulsed ⁽¹⁾	I _{DM}	36	ADC
Continuous Drain Current (T _c = 25°C)	I _D	8.3	ADC
Continuous Drain Current (T _c = 100°C)	I _D	5.3	ADC
Single Pulsed Avalanch Current(Energy ⁽²⁾)	I _{AS} (EAS)	33(950)	A(mJ)
Maximum Supply Voltage	V _{CC,MAX}	40	V
Input Voltage Range	V _{FB}	-0.3 to V _{CC}	V
	V _{Sync}	-0.3 to 13	V
Total Power Dissipation	P _D	95	W
Operating Junction Temperature.	T _J	+160	°C
Operating Ambient Temperature.	T _A	-25 to +85	°C
Storage Temperature Range.	T _{STG}	-55 to +150	°C
Thermal Resistance	R _{thjc}	2.7	°C/W
ESD Capability, HBM Model (All pins)		2.0	kV
ESD Capability, Machine Model (All pins)		300	V
KA5Q1565RF			
Drain-source Voltage	V _{DSS}	650	V
Drain-Gate Voltage(R _{GS} =1MΩ)	V _{DGR}	650	V
Gate-Source(GND) Voltage	V _{GS}	±30	V
Drain Current Pulsed ⁽¹⁾	I _{DM}	60	ADC
Continuous Drain Current (T _c = 25°C)	I _D	10.3	ADC
Continuous Drain Current (T _c = 100°C)	I _D	6.6	ADC
Single Pulsed Avalanch Current(Energy ⁽²⁾)	I _{AS} (EAS)	36(1050)	A(mJ)
Maximum Supply Voltage	V _{CC,MAX}	40	V
Input Voltage Range	V _{FB}	-0.3 to V _{CC}	V
	V _{Sync}	-0.3 to 13	V
Total Power Dissipation	P _D	98	W
Operating Junction Temperature.	T _J	+160	°C
Operating Ambient Temperature.	T _A	-25 to +85	°C
Storage Temperature Range.	T _{STG}	-55 to +150	°C
Thermal Resistance	R _{thjc}	2.7	°C/W
ESD Capability, HBM Model (All pins)		2.0	kV
ESD Capability, Machine Model (All pins)		300	V

Note:

1. Repetitive rating : Pulse width limited by maximum junction temperature
2. L = 10mH, V_{DD} =50V, R_G = 27Ω, starting T_J = 25°C
3. L = 13uH, starting T_J = 25°C

Electrical Characteristics (SFET part)

(Ta=25°C unless otherwise specified)

Parameter	Symbol	Conditions	Min.	Typ.	Max.	Unit
KA5Q0765RT						
Drain-Source Breakdown Voltage	BVDSS	VGS=0V, ID=50μA	650	-	-	V
Zero Gate Voltage Drain Current	IDSS	VDS=Max., Rating, VGS=0V	-	-	200	μA
		VDS=0.8Max., Rating, VGS=0V, TC=85°C	-	-	300	μA
Static Drain-Source on Resistance ⁽¹⁾	RDS(on)	VGS=10V, ID=4.0A	-	1.3	1.6	Ω
Input Capacitance	Ciss	VGS=0V, VDS=25V, f = 1MHz	-	1110	-	pF
Output Capacitance	Coss		-	105	-	
Reverse Transfer Capacitance	Crss		-	50	-	
Turn on Delay Time	td(on)	VDD=0.5BVDSS, ID=7.0A (MOSFET switching time are essentially independent of operating temperature)	-	25	-	nS
Rise Time	tr		-	55	-	
Turn Off Delay Time	td(off)		-	80	-	
Fall Time	tf		-	50	-	
Total Gate Charge (Gate-Source+Gate-Drain)	Qg	VGS=10V, ID=7.0A, VDS=0.5BVDSS(MOSFET Switching time are Essentially independent of Operating temperature)	-	57	74	nC
Gate-Source Charge	Qgs		-	9.3	-	
Gate-Drain (Miller) Charge	Qgd		-	29.3	-	
KA5Q12656RT/KA5Q1265RF						
Drain-Source Breakdown Voltage	BVDSS	VGS=0V, ID=50μA	650	-	-	V
Zero Gate Voltage Drain Current	IDSS	VDS=Max., Rating, VGS=0V	-	-	200	μA
		VDS=0.8Max., Rating, VGS=0V, TC=85°C	-	-	300	μA
Static Drain-Source on Resistance ⁽¹⁾	RDS(on)	VGS=10V, ID=6A	-	0.7	0.9	Ω
Input Capacitance	Ciss	VGS=0V, VDS=25V, f = 1MHz	-	1820	-	pF
Output Capacitance	Coss		-	185	-	
Reverse Transfer Capacitance	Crss		-	32	-	
Turn on Delay Time	td(on)	VDD=0.5BVDSS, ID=12.0A (MOSFET switching time are essentially independent of operating temperature)	-	38	-	nS
Rise Time	tr		-	120	-	
Turn Off Delay Time	td(off)		-	200	-	
Fall Time	tf		-	100	-	
Total Gate Charge (Gate-Source+Gate-Drain)	Qg	VGS=10V, ID=12.0A, VDS=0.5BVDSS(MOSFET Switching time are Essentially independent of Operating temperature)	-	60	78	nC
Gate-Source Charge	Qgs		-	10	-	
Gate-Drain (Miller) Charge	Qgd		-	30	-	

Absolute Maximum Ratings (SFET Part)

(Ta=25°C, unless otherwise specified)

Characteristic	Symbol	Test condition	Min.	Typ.	Max.	Unit
KA5Q1565RF						
Drain-Source Breakdown Voltage	BVDSS	VGS=0V, ID=50μA	650	-	-	V
Zero Gate Voltage Drain Current	IDSS	VDS=Max., Rating, VGS=0V	-	-	200	μA
		VDS=0.8Max., Rating, VGS=0V, TC=85°C	-	-	300	μA
Static Drain-Source on Resistance ^(Note)	RDS(ON)	VGS=10V, ID=7.3A	-	0.5	0.65	W
Input Capacitance	Ciss	VGS=0V, VDS=25V, f=1MHz	-	2580	-	pF
Output Capacitance	Coss		-	270	-	
Reverse Transfer Capacitance	Crss		-	50	-	
Turn on Delay Time	td(on)	VDD=0.5BVDSS, ID=14.6A (MOSFET switching time are essentially independent of operating temperature)	-	50	-	nS
Rise Time	tr		-	155	-	
Turn Off Delay Time	td(off)		-	270	-	
Fall Time	tf		-	125	-	
Total Gate Charge (Gate-Source+Gate-Drain)	Qg	VGS=10V, ID=14.6A, VDS=0.8BVDSS (MOSFET switching time are essentially independent of operating temperature)	-	90	117	nC
Gate-Source Charge	Qgs		-	15	-	
Gate-Drain (Miller) Charge	Qgd		-	45	-	

Note:

1. Pulse test: Pulse width ≤ 300μS, duty cycle ≤ 2%

Electrical Characteristics (Control Part)

(Ta=25°C unless otherwise specified)

Parameter	Symbol	Conditions	Min.	Typ.	Max.	Unit
UVLO SECTION						
Start Threshold Voltage	V _{START}	V _{FB} =GND	14	15	16	V
Stop Threshold Voltage	V _{STOP}	V _{FB} =GND	8	9	10	V
OSCILLATOR SECTION						
Initial Frequency	F _{OSC}	-	18	20	22	kHz
Voltage Stability	F _{STABLE}	12V ≤ V _{CC} ≤ 23V	0	1	3	%
Temperature Stability (Note2)	ΔF _{OSC}	-25°C ≤ Ta ≤ 85°C	0	±5	±10	%
Maximum Duty Cycle	D _{MAX}	-	92	95	98	%
Minimum Duty Cycle	D _{MIN}	-	-	-	0	%
FEEDBACK SECTION						
Feedback Source Current	I _{FB}	V _{FB} =GND	0.7	0.9	1.1	mA
Shutdown Feedback Voltage	V _{SD}	V _{FB} ≥ 6.9V	6.9	7.5	8.1	V
Shutdown Delay Current	I _{DELAY}	V _{FB} =5V	4	5	6	μA
SYNC. SECTION						
Normal Sync High Threshold Voltage	V _{NSH}	V _{CC} =16V, V _{fb} =5V	4.0	4.6	5.2	V
Normal Sync Low Threshold Voltage	V _{NSL}	V _{CC} =16V, V _{fb} =5V	2.3	2.6	2.9	V
Burst Sync High Threshold Voltage	V _{BSH}	V _{CC} =10.5V, V _{fb} =0V	3.2	3.6	4.0	V
Burst Sync Low Threshold Voltage	V _{BSL}	V _{CC} =10.5V, V _{fb} =0V	1.1	1.3	1.5	V
BURST MODE SECTION						
Burst Mode Low Threshold Voltage	V _{BURL}	V _{FB} =0V	10.4	11.0	11.6	V
Burst Mode High Threshold Voltage	V _{BURH}	V _{FB} =0V	11.4	12.0	12.6	V
Burst Mode Enable Feedback Voltage	V _{BEN}	V _{CC} =10.5V	0.7	1.0	1.3	V
Burst Mode Peak Current Limit(Note4)	I _{BURPK}	V _{CC} =10.5V, V _{FB} =0V	0.65	0.85	1.1	A
CURRENT LIMIT(SELF-PROTECTION)SECTION						
Peak Current Limit (Note4)	I _{OVER}	KA5Q0765RT	4.40	5.00	5.60	A
		KA5Q12656RT	5.28	6.00	6.72	
		KA5Q1265RF	7.04	8.00	8.96	
		KA5Q1565RF	10.12	11.50	12.88	
PROTECTION SECTION						
Over Voltage Protection	V _{OV} P	V _{SYNC} ≥ 11V	11	12	13	V
Over Current Latch voltage(Note3)	V _{OCL}	-	0.9	1.0	1.1	V
Thermal Shutdown Tempature(Note2)	T _{SD}	-	140	160	-	°C

Electrical Characteristics (Control Part) (Continued)

(Ta=25°C unless otherwise specified)

Parameter	Symbol	Conditions	Min.	Typ.	Max.	Unit
TOTAL DEVICE SECTION						
Start Up Current	I _{START}	V _{FB} =GND, V _{CC} =14V	-	0.1	0.2	mA
Operating Supply Current(Note1)	I _{OP}	V _{FB} =GND, V _{CC} =16V	-	10	18	mA
	I _{OP(MIN)}	V _{FB} =GND, V _{CC} =12V				
	I _{OP(MAX)}	V _{FB} =GND, V _{CC} =28V				
PRIMARY SIDE REGULATION SECTION (ONLY KA5Q0765RT/KA5Q12656RT)						
Primary Regulation Threshold Voltage	V _{PR}	I _{FB} =700uA, V _{FB} =4V	32.0	32.5	33.0	V
Primary Regulation Transconductance	G _{PR}	-	2.0	2.6	-	mA/V

Note:

1. These parameters is the Current Flowing in the Control IC.
2. These parameters, although guaranteed, are not 100% tested in production
3. These parameters, although guaranteed, are tested in EDS(wafer test) process
4. These parameters are indicated Inductor Current.

Typical Performance Characteristics

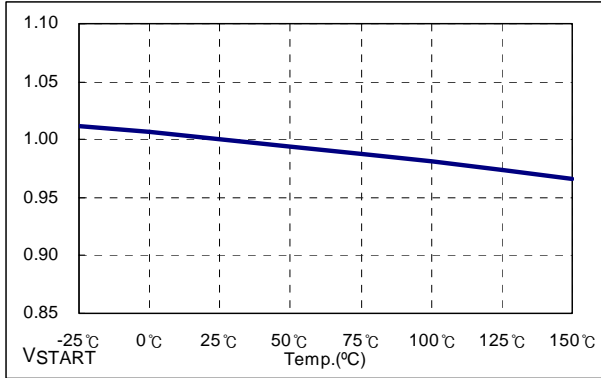

Figure 1. Start Threshold Voltage

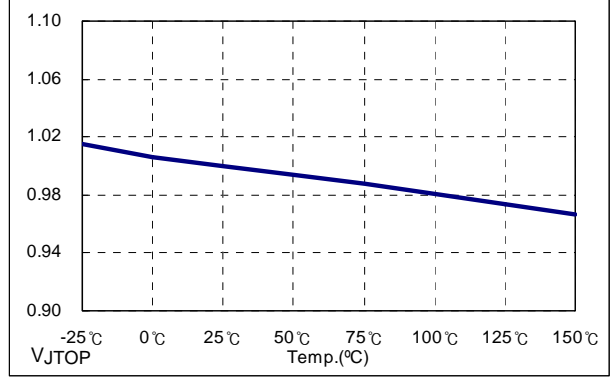

Figure 2. Stop Threshold Voltage

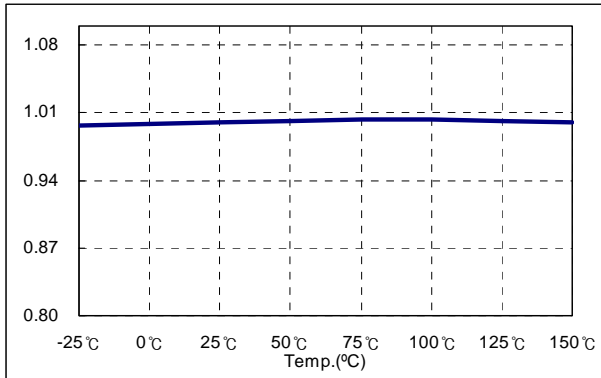

Figure 3. Start Up Current

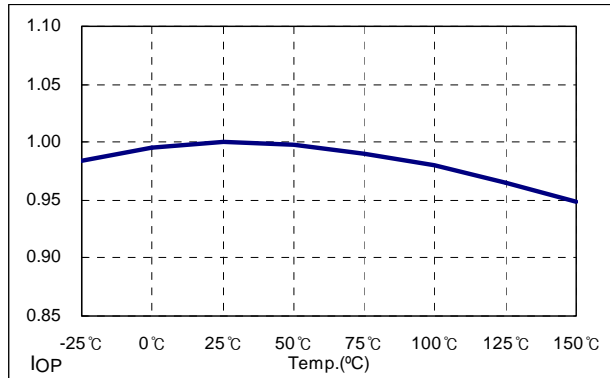

Figure 4. Operating Supply Current

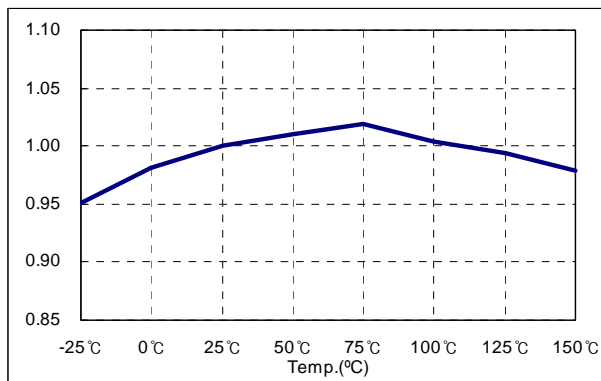

Figure 5. Initial Frequency

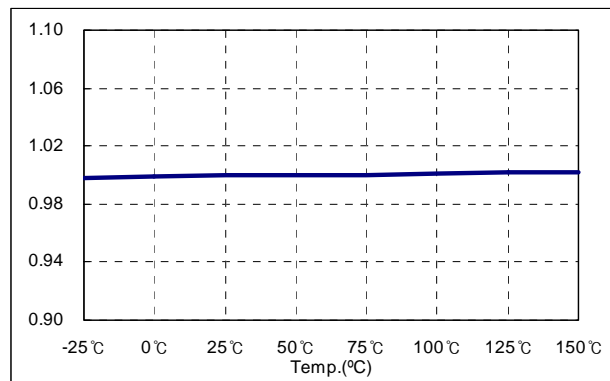

Figure 6. Maximum Duty

Typical Performance Characteristics (Continued)

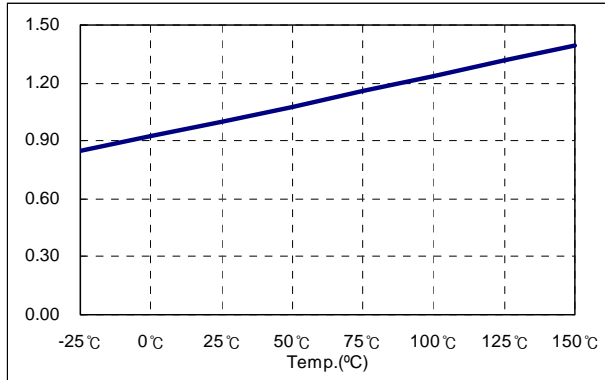

Figure 7. Feedback Offset Voltage

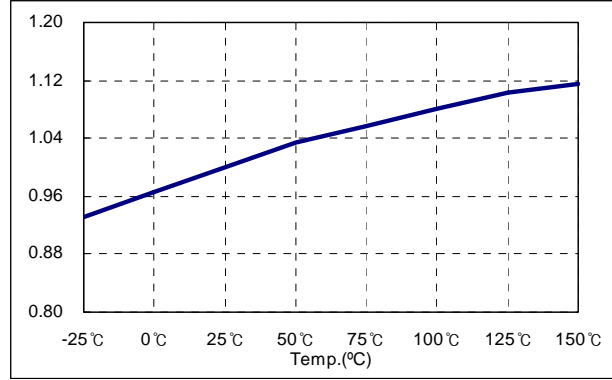

Figure 8. Feedback Source Current

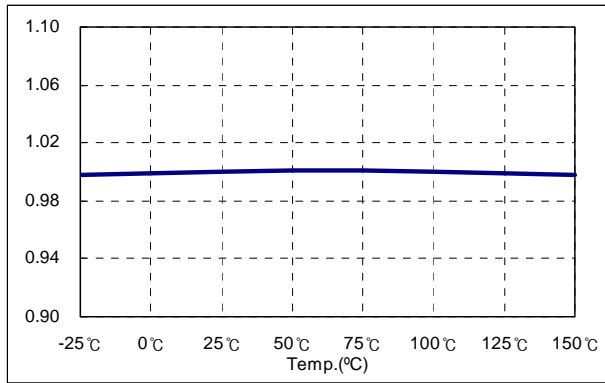

Figure 9. Over Voltage Protection

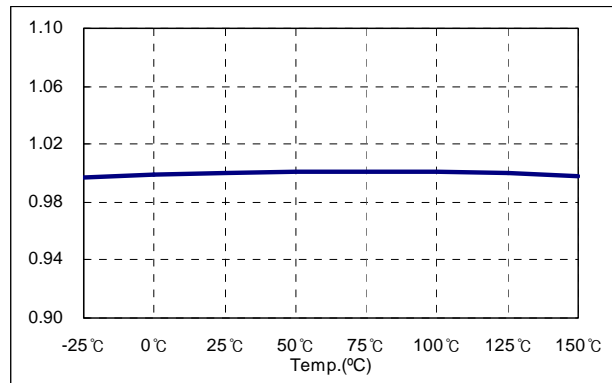

Figure 10. Shutdown Feedback Voltage

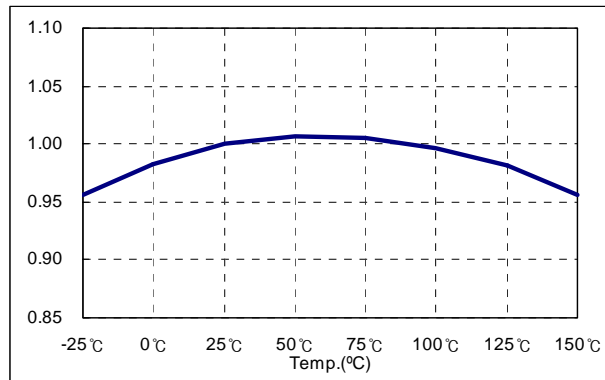

Figure 11. Shutdown Delay Current

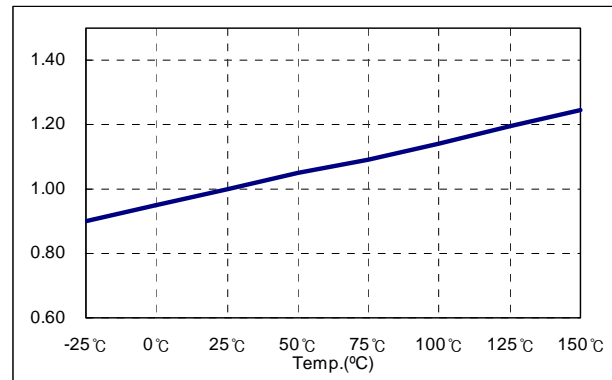

Figure 12. Burst mode Enable Feedback Voltage

Typical Performance Characteristics (Continued)

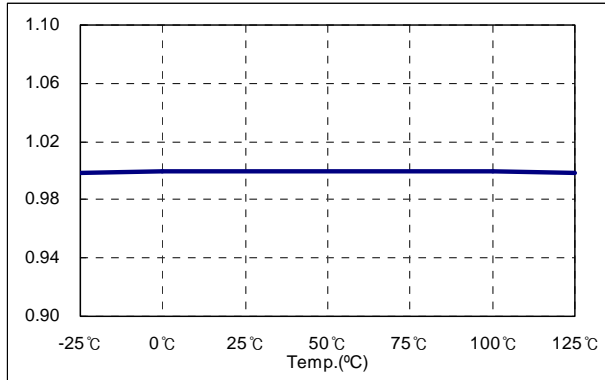

Figure 13. Burst mode Low Threshold Voltage

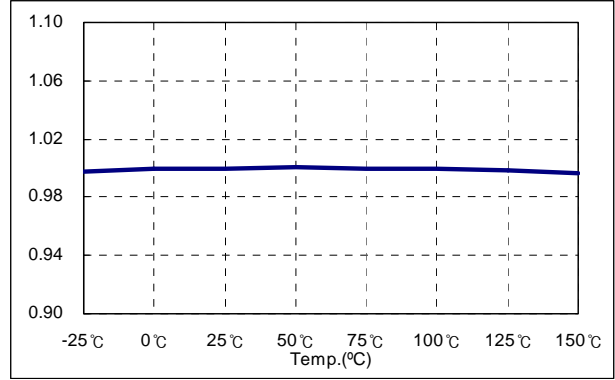

Figure 14. Burst mode High Threshold Voltage

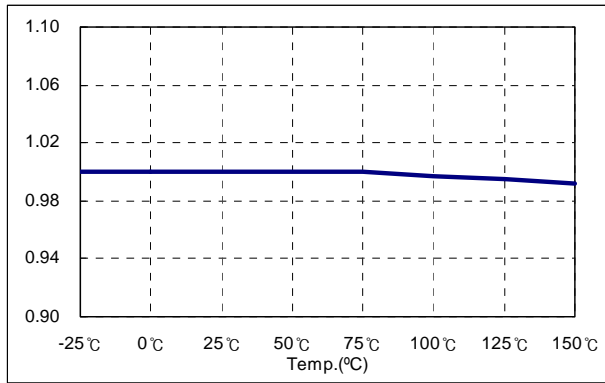

Figure 15. Burst Sync. High Threshold Voltage

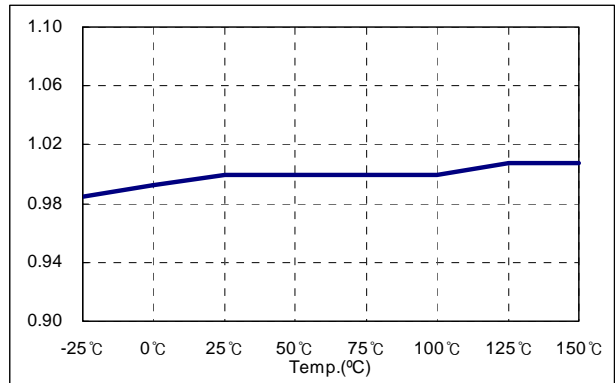

Figure 16. Burst Sync. Low Threshold Voltage

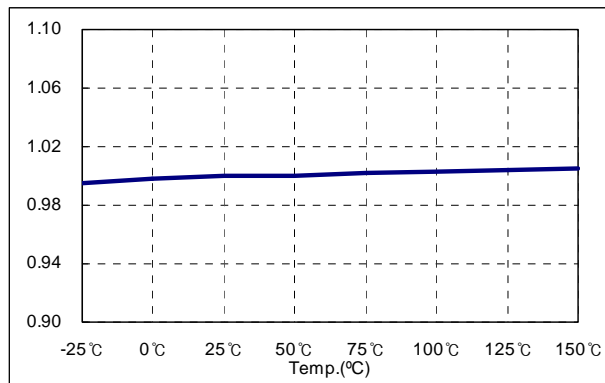

Figure 17. Primary Regulation Threshold Voltage

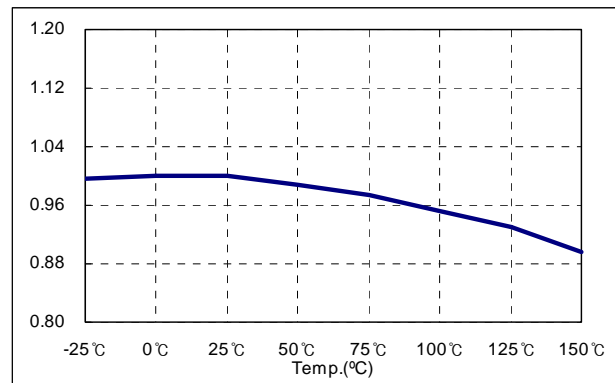

Figure 18. Primary Regulation Transconductance

Typical Performance Characteristics (Continued)

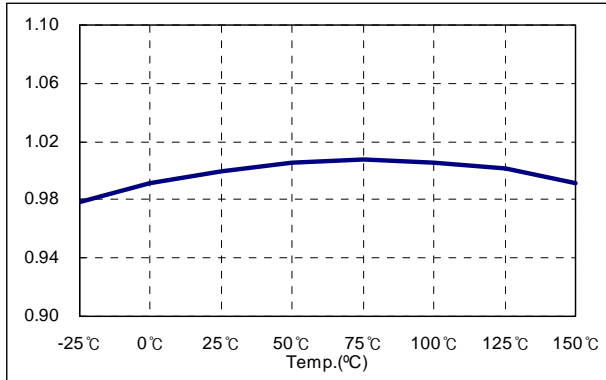

Figure 19. Peak Current Limit

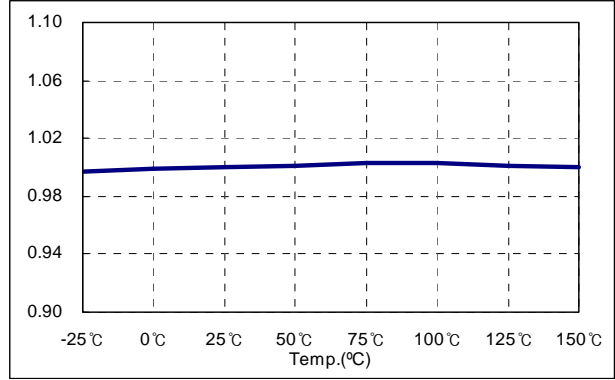

Figure 20. Burst mode Peak Current Limit

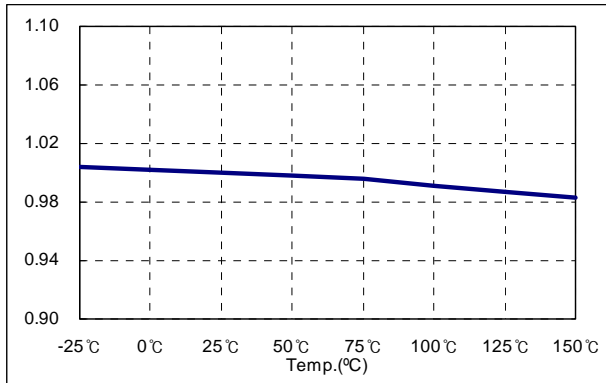

Figure 21. Normal Sync. High Threshold Voltage

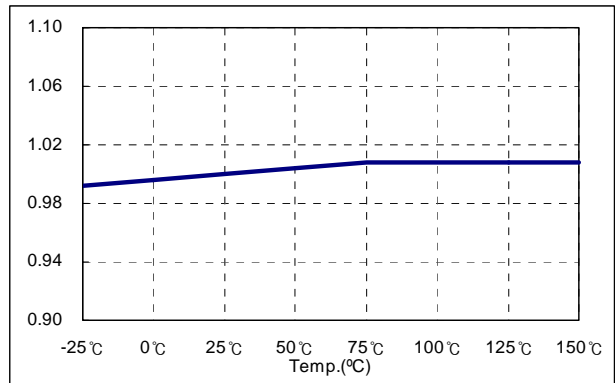
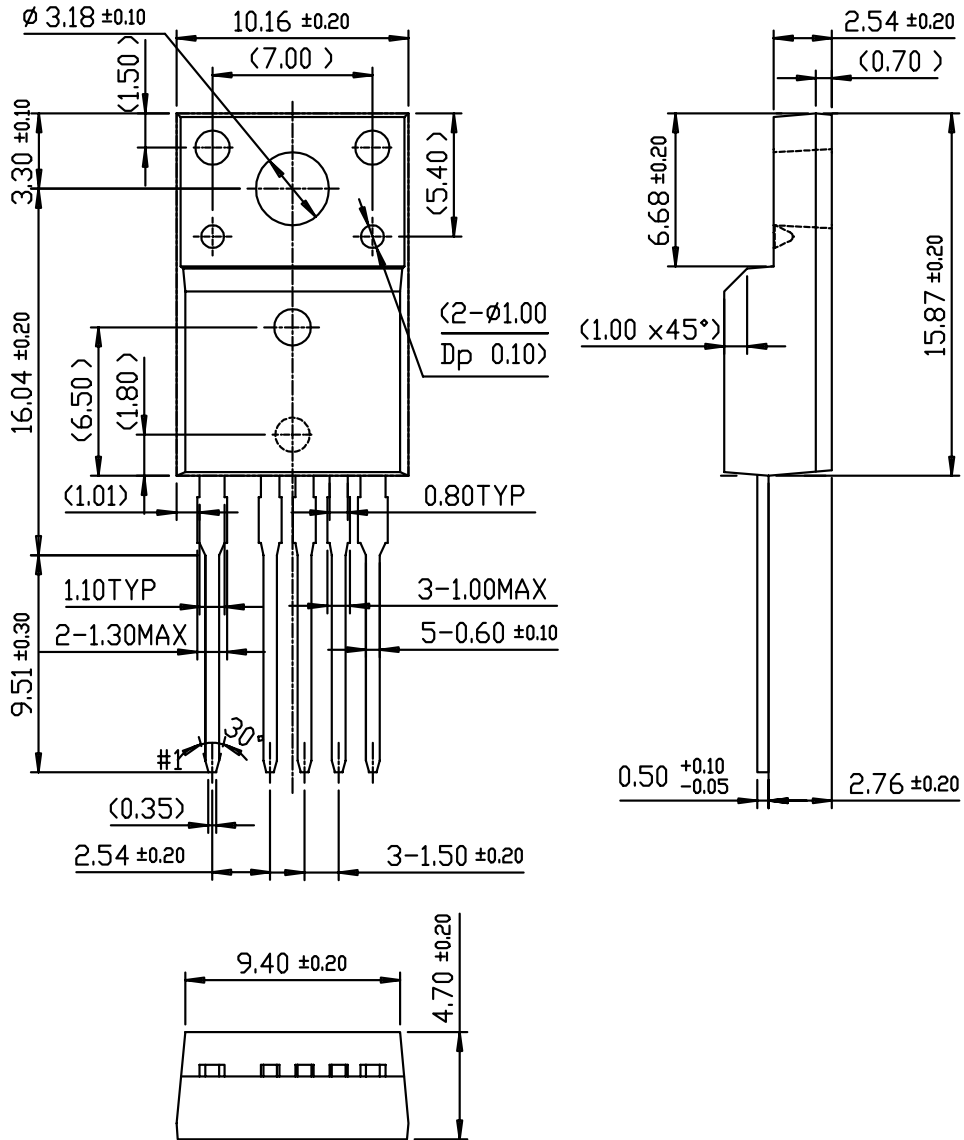

Figure 22. Normal Sync. Low Threshold Voltage

Package Dimensions

TO-220F-5L



Package Dimensions (Continued)

TO-220F-5L(Forming)

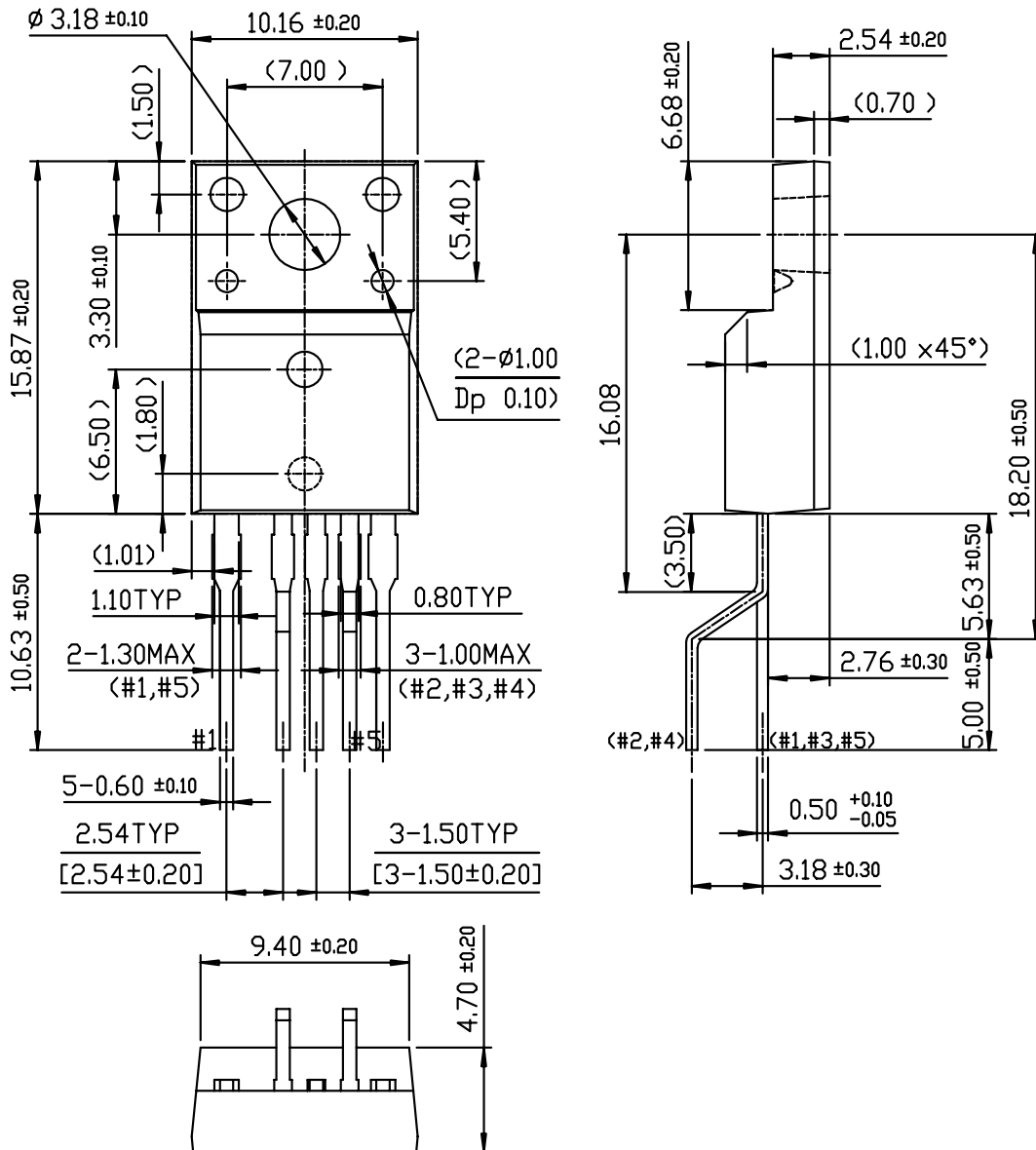

Package Dimensions (Continued)

TO-3PF-5L

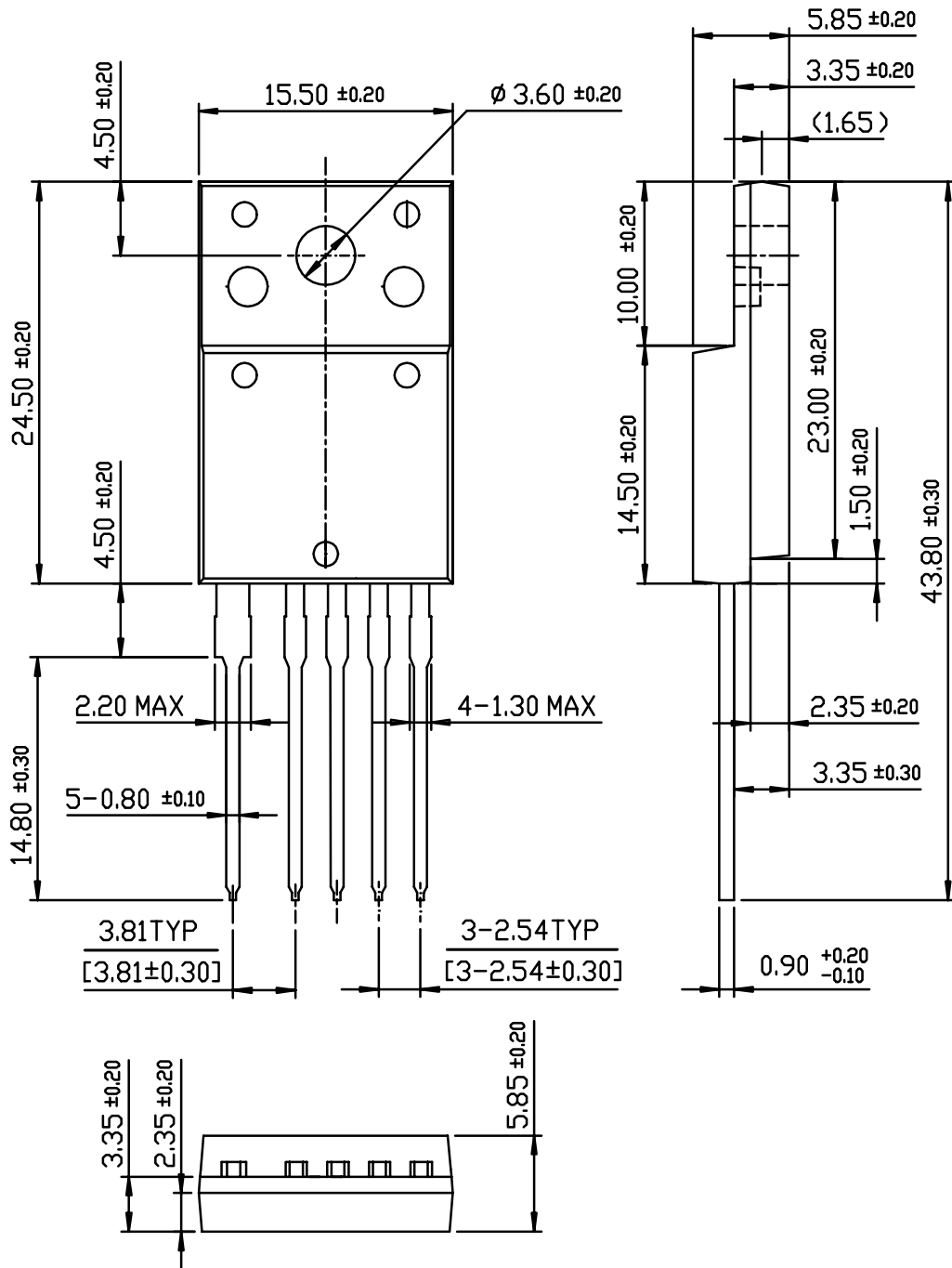

Package Dimensions (Continued)

TO-3PF-5L(Forming)

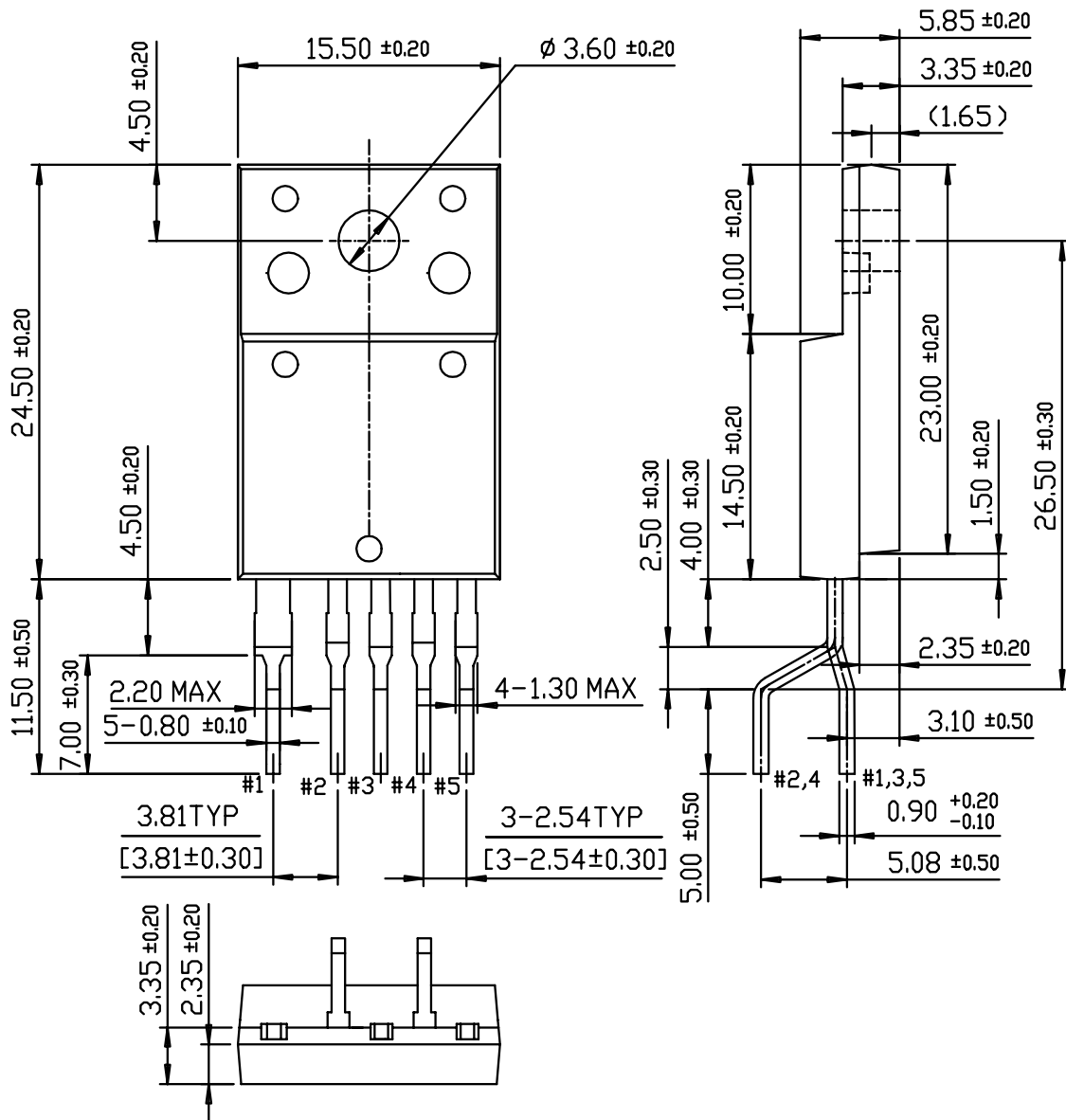

Ordering Information

Product Number	Package	Rating	IOVER
KA5Q0765RTTU	TO-220F-5L	650V, 7A	5A
KA5Q0765RTYDTU	TO-220F-5L (Forming)		
KA5Q12656RTTU	TO-220F-5L	650V, 12A	6A
KA5Q12656RTYDTU	TO-220F-5L (Forming)		
KA5Q1265RFTU	TO-3PF-5L	650V, 12A	8A
KA5Q1265RFYDTU	TO-3PF-5L (Forming)		
KA5Q1565RFTU	TO-3PF-5L	650V, 15A	11.5A
KA5Q1565RFYDTU	TO-3PF-5L (Forming)		

TU : Non Forming Type

YDTU : Forming Type

DISCLAIMER

FAIRCHILD SEMICONDUCTOR RESERVES THE RIGHT TO MAKE CHANGES WITHOUT FURTHER NOTICE TO ANY PRODUCTS HEREIN TO IMPROVE RELIABILITY, FUNCTION OR DESIGN. FAIRCHILD DOES NOT ASSUME ANY LIABILITY ARISING OUT OF THE APPLICATION OR USE OF ANY PRODUCT OR CIRCUIT DESCRIBED HEREIN; NEITHER DOES IT CONVEY ANY LICENSE UNDER ITS PATENT RIGHTS, NOR THE RIGHTS OF OTHERS.

LIFE SUPPORT POLICY

FAIRCHILD'S PRODUCTS ARE NOT AUTHORIZED FOR USE AS CRITICAL COMPONENTS IN LIFE SUPPORT DEVICES OR SYSTEMS WITHOUT THE EXPRESS WRITTEN APPROVAL OF THE PRESIDENT OF FAIRCHILD SEMICONDUCTOR CORPORATION. As used herein:

1. Life support devices or systems are devices or systems which, (a) are intended for surgical implant into the body, or (b) support or sustain life, and (c) whose failure to perform when properly used in accordance with instructions for use provided in the labeling, can be reasonably expected to result in a significant injury of the user.
2. A critical component in any component of a life support device or system whose failure to perform can be reasonably expected to cause the failure of the life support device or system, or to affect its safety or effectiveness.

ON Semiconductor and  are trademarks of Semiconductor Components Industries, LLC dba ON Semiconductor or its subsidiaries in the United States and/or other countries. ON Semiconductor owns the rights to a number of patents, trademarks, copyrights, trade secrets, and other intellectual property. A listing of ON Semiconductor's product/patent coverage may be accessed at www.onsemi.com/site/pdf/Patent-Marking.pdf. ON Semiconductor reserves the right to make changes without further notice to any products herein. ON Semiconductor makes no warranty, representation or guarantee regarding the suitability of its products for any particular purpose, nor does ON Semiconductor assume any liability arising out of the application or use of any product or circuit, and specifically disclaims any and all liability, including without limitation special, consequential or incidental damages. Buyer is responsible for its products and applications using ON Semiconductor products, including compliance with all laws, regulations and safety requirements or standards, regardless of any support or applications information provided by ON Semiconductor. "Typical" parameters which may be provided in ON Semiconductor data sheets and/or specifications can and do vary in different applications and actual performance may vary over time. All operating parameters, including "Typicals" must be validated for each customer application by customer's technical experts. ON Semiconductor does not convey any license under its patent rights nor the rights of others. ON Semiconductor products are not designed, intended, or authorized for use as a critical component in life support systems or any FDA Class 3 medical devices or medical devices with a same or similar classification in a foreign jurisdiction or any devices intended for implantation in the human body. Should Buyer purchase or use ON Semiconductor products for any such unintended or unauthorized application, Buyer shall indemnify and hold ON Semiconductor and its officers, employees, subsidiaries, affiliates, and distributors harmless against all claims, costs, damages, and expenses, and reasonable attorney fees arising out of, directly or indirectly, any claim of personal injury or death associated with such unintended or unauthorized use, even if such claim alleges that ON Semiconductor was negligent regarding the design or manufacture of the part. ON Semiconductor is an Equal Opportunity/Affirmative Action Employer. This literature is subject to all applicable copyright laws and is not for resale in any manner.

PUBLICATION ORDERING INFORMATION

LITERATURE FULFILLMENT:

Literature Distribution Center for ON Semiconductor
19521 E. 32nd Pkwy, Aurora, Colorado 80011 USA
Phone: 303-675-2175 or 800-344-3860 Toll Free USA/Canada
Fax: 303-675-2176 or 800-344-3867 Toll Free USA/Canada
Email: orderlit@onsemi.com

N. American Technical Support: 800-282-9855 Toll Free
USA/Canada
Europe, Middle East and Africa Technical Support:
Phone: 421 33 790 2910
Japan Customer Focus Center
Phone: 81-3-5817-1050

ON Semiconductor Website: www.onsemi.com
Order Literature: <http://www.onsemi.com/orderlit>
For additional information, please contact your local
Sales Representative