

TDK-Lambda

PXB15-xxWDxx

Dual Output 15 Watt DC/DC Converters

(with wide range input)



The PXB15 series is approved to UL/CSA/EN/IEC 60950-1.

Table of contents

Absolute Maximum Rating	P2	Thermal Consideration	P21
Output Specification	P2	Heat Sink Consideration	P21
Input Specification	P3	Remote ON/OFF Control	P22
General Specification	P4	Mechanical Data	P23
Characteristic Curves	P5	Recommended Pad Layout	P24
Testing Configurations	P17	Soldering Considerations	P25
EMC Consideration	P18	Packaging Information	P25
Input Source Impedance	P20	Part Number Structure	P26
Output Over Current Protection	P20	Safety and Installation Instruction	P26
Output Over Voltage Protection	P20	MTBF and Reliability	P26
Short Circuit Protection	P21		

Absolute Maximum Rating				
Parameter	Model	Min	Max	Unit
Input Voltage	24WDXX 48WDXX		36	V _{DC}
			75	
Transient (100mS)	24WDXX 48WDXX		50	
			100	
Input Voltage Variation (complies with ETS300 132 part 4.4)	All		5	V/mS
Operating Ambient Temperature (with derating)	All	-40	85	°C
Operating Case Temperature			105	°C
Storage Temperature	All	-55	125	°C

Output Specification					
Parameter	Model	Min	Typ	Max	Unit
Output Voltage (V _{in} = V _{in} (nom) ; Full Load ; T _A =25 °C)	XXWD05	4.95	5	5.05	V _{DC}
	XXWD12	11.88	12	12.12	
	XXWD15	14.85	15	15.15	
Output Regulation Line (V _{in} (min) to V _{in} (max) at Full Load) Load (0% to 100% of Full Load)	All	-0.5		+0.5	%
		-1.0		+1.0	
Cross Regulation Asymmetrical Load 25% / 100% of Full Load	All	-5		5	%
Output Ripple & Noise(See Page 17) Peak-to-Peak (20MHz bandwidth) (Measured with a 1uF M/C and a 10uF T/C)	All		100		mV _{P-P}
Temperature Coefficient	All	-0.02		+0.02	%/°C
Output Voltage Overshoot (V _{in} (min) to V _{in} (max) ; Full Load ; T _A =25 °C)	All		0	3	% V _{OUT}
Dynamic Load Response (V _{in} = V _{in} (nom) ; T _A =25 °C) Load step change from 75% to 100% or 100 to 75% of Full Load Peak Deviation	All		300		mV
	All		250		µS
Output Current	XXWD05	0		±1500	mA
	XXWD12	0		±625	
	XXWD15	0		±500	
Output Over Voltage Protection (Voltage Clamped)	XXWD05	5.6		7.0	V _{DC}
	XXWD12	13.5		19.6	
	XXWD15	16.8		20.5	
Output Over Current Protection	All		150		% FL.
Output Short Circuit Protection	All	Hiccup, automatic recovery			

Input Specification						
Parameter	Model	Min	Typ	Max	Unit	
Operating Input Voltage	24WDXX	9	24	36	V _{DC}	
	48WDXX	18	48	75		
Input Current (Maximum value at V _{in} = V _{in} (nom); Full Load)	24WD05			772	mA	
	24WD12			753		
	24WD15			744		
	48WD05			386		
	48WD12			382		
	48WD15			377		
Input Standby Current (Typical value at V _{in} = V _{in} (nom) ; No Load)	24WD05		20		mA	
	24WD12		25			
	24WD15		25			
	48WD05		15			
	48WD12		15			
	48WD15		20			
Under Voltage Lockout Turn-on Threshold	24WDXX			9	V _{DC}	
	48WDXX			18		
Under Voltage Lockout Turn-off Threshold	24WDXX		8		V _{DC}	
	48WDXX		16			
Input Reflected Ripple Current (See Page 17) (5 to 20MHz, 12μH source impedance)	All		30		mA _{P-P}	
Start Up Time (V _{in} = V _{in} (nom) and constant resistive load)						
	Power up	All		30	mS	
	Remote ON/OFF			30		
Remote ON/OFF Control (See Page 22) (The ON/OFF pin voltage is referenced to -V _{IN})	Negative Logic DC-DC ON(Short)	All	0	1.2	V _{DC}	
	DC-DC OFF(Open)		3	15		
	Positive Logic DC-DC ON(Open)		3	15		
	DC-DC OFF(Short)		0	1.2		
Remote Off Input Current	All		2.5		mA	
Input Current of Remote Control Pin	All	-0.5		1.0	mA	

General Specification					
Parameter	Model	Min	Typ	Max	Unit
Efficiency(See Page 17) ($V_{in} = V_{in(nom)}$; Full Load ; $T_A=25\text{ }^\circ\text{C}$)	24WD05		85		%
	24WD12		87		
	24WD15		88		
	48WD05		85		
	48WD12		86		
	48WD15		87		
Isolation Voltage Input to Output Input (Output) to Case	All	1600 1000			V_{DC}
Isolation Resistance	All	1			G Ω
Isolation Capacitance	All			1000	pF
Switching Frequency	All		400		KHz
Weight	All		15		g
MTBF(See Page 26) Bellcore TR-NWT-000332, $T_C=40\text{ }^\circ\text{C}$ MIL-HDBK-217F	All		1.330x10 ⁶ 5.630x10 ⁵		hours

Characteristic Curves

All test conditions are at 25 °C. PXB15-24WD05

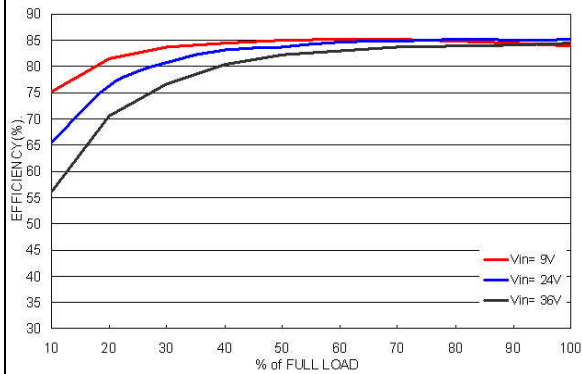

Efficiency versus Output Current

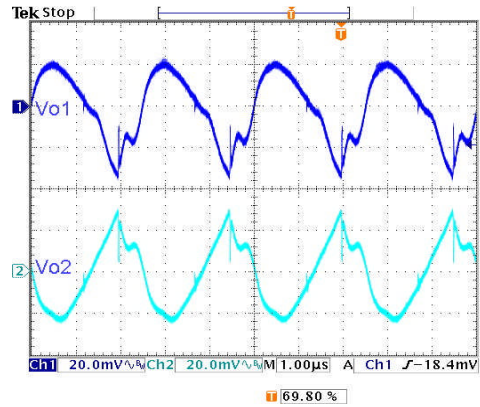

Typical Output Ripple and Noise.
Vin = Vin(nom) ; Full Load

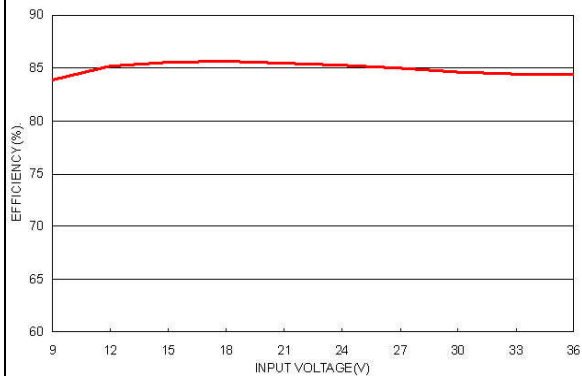

Efficiency versus Input Voltage. Full Load

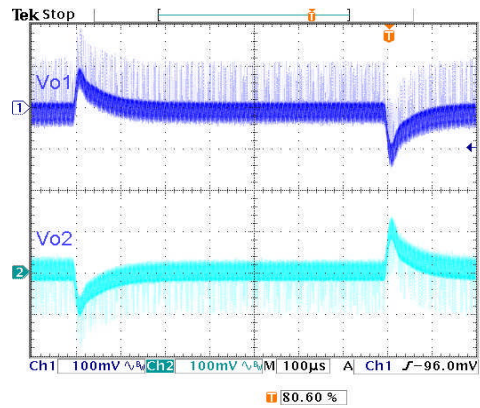

Transient Response to Dynamic Load Change from
100% to 75% to 100% of Full Load ; Vin = Vin(nom)

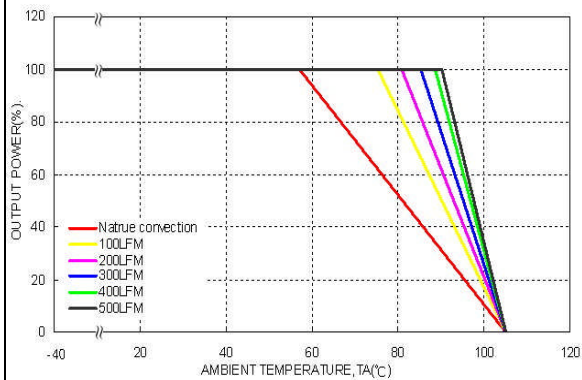

Derating Output Current versus Ambient Temperature and Airflow
Vin = Vin(nom)

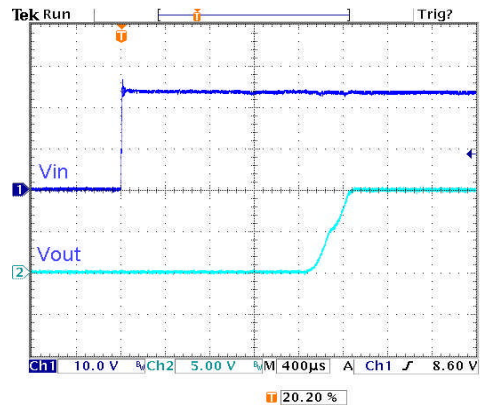

Typical Input Start-Up and Output Rise Characteristic
Vin = Vin(nom) ; Full Load

Characteristic Curves (Continued)

All test conditions are at 25 °C. PXB15-24WD05

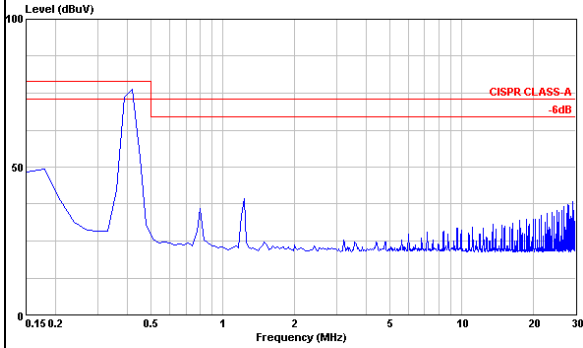

Conduction Emission of EN55022 Class A
 $V_{in} = V_{in(nom)}$; Full Load

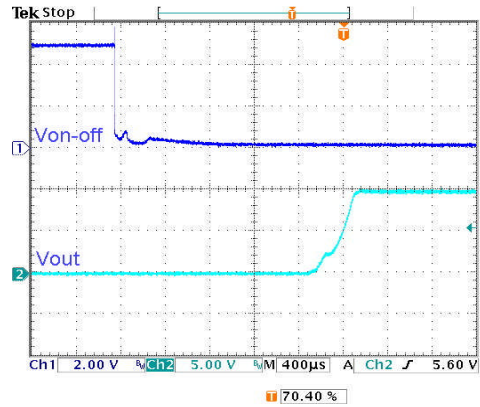

Using ON/OFF Voltage Start-Up and Vo Rise Characteristic
 $V_{in} = V_{in(nom)}$; Full Load

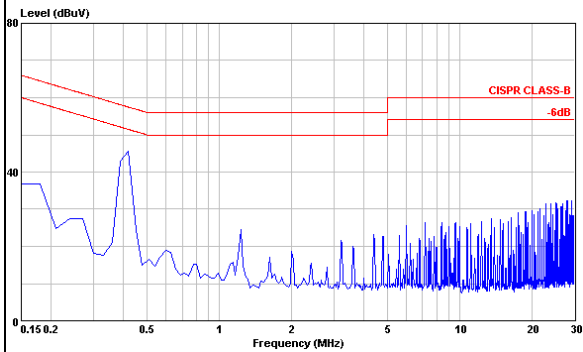

Conduction Emission of EN55022 Class B
 $V_{in} = V_{in(nom)}$; Full Load

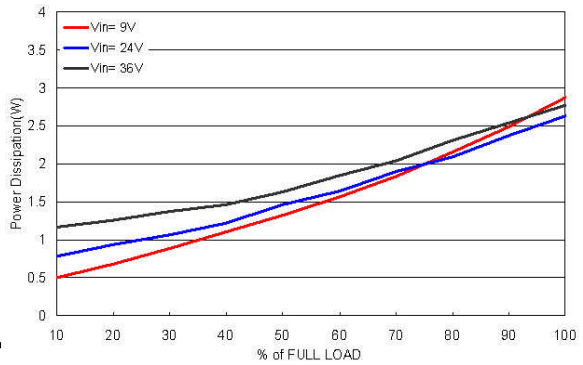

Power Dissipation versus Output Current

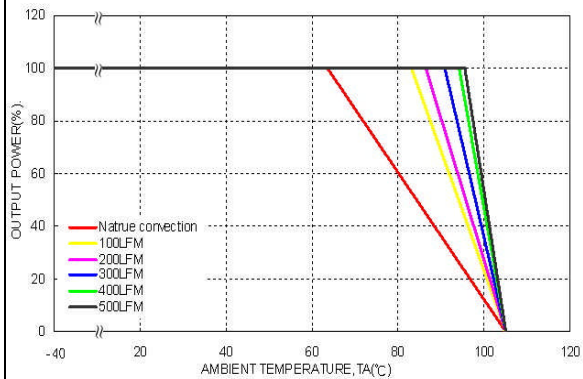

Derating Output Current Versus Ambient Temperature with Heat-Sink
and Airflow, $V_{in} = V_{in(nom)}$

Characteristic Curves (Continued)

All test conditions are at 25 °C. PXB15-24WD12

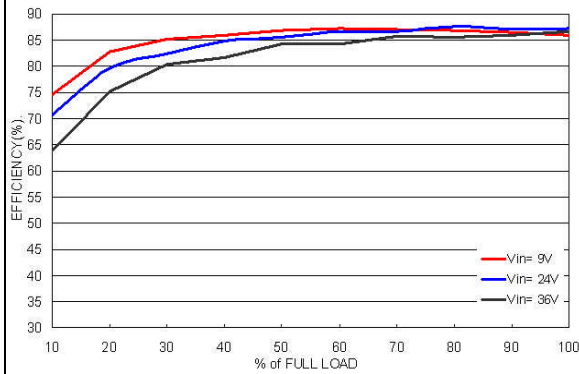

Efficiency versus Output Current

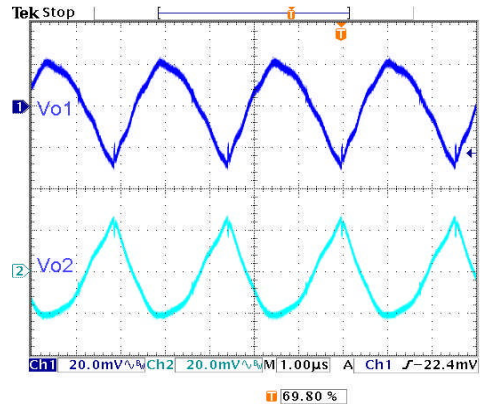

Typical Output Ripple and Noise.
Vin = Vin(nom) ; Full Load

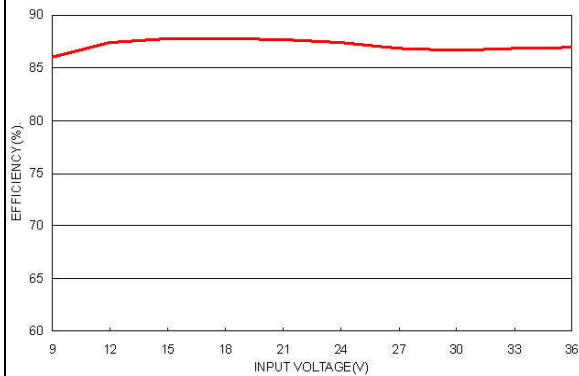

Efficiency versus Input Voltage. Full Load

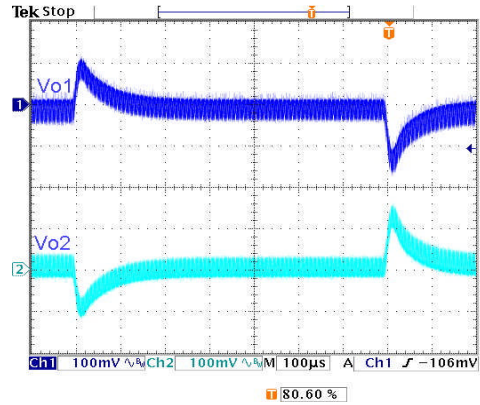

Transient Response to Dynamic Load Change from 100% to 75% to 100% of Full Load ; Vin = Vin(nom)

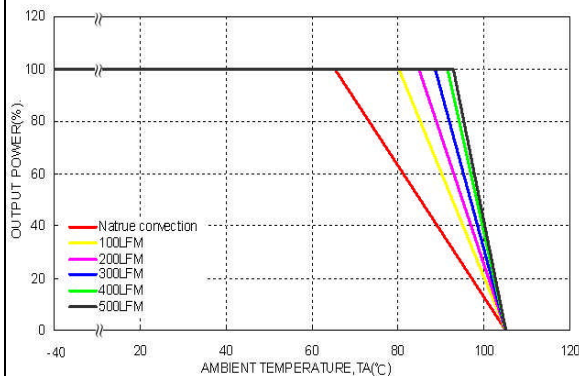

Derating Output Current versus Ambient Temperature and Airflow
Vin = Vin(nom)

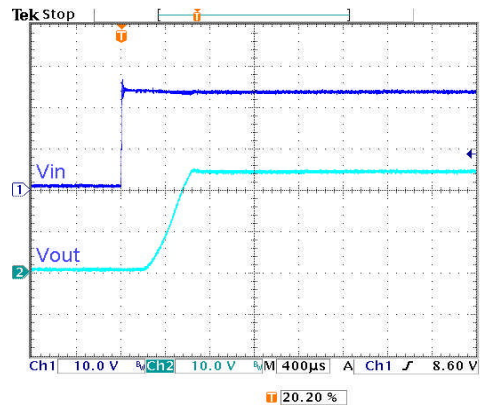

Typical Input Start-Up and Output Rise Characteristic
Vin = Vin(nom) ; Full Load

Characteristic Curves (Continued)

All test conditions are at 25 °C. PXB15-24WD12

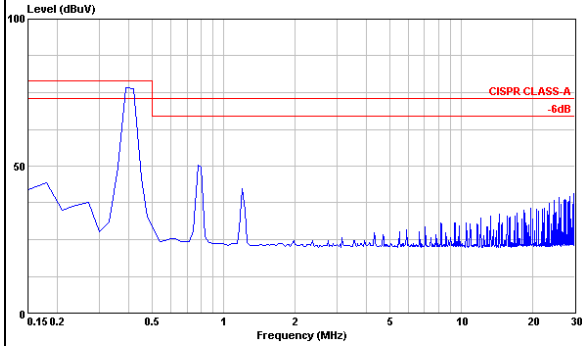

Conduction Emission of EN55022 Class A
 $V_{in} = V_{in(nom)}$; Full Load

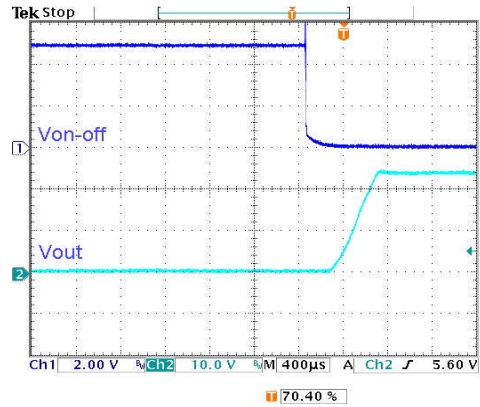

Using ON/OFF Voltage Start-Up and Vo Rise Characteristic
 $V_{in} = V_{in(nom)}$; Full Load

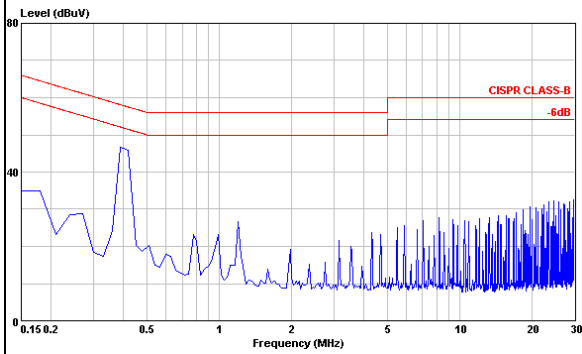

Conduction Emission of EN55022 Class B
 $V_{in} = V_{in(nom)}$; Full Load

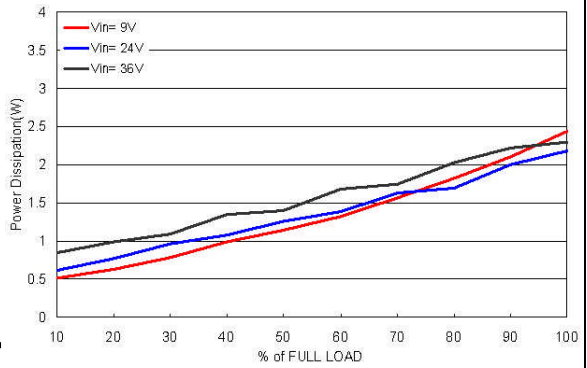

Power Dissipation versus Output Current

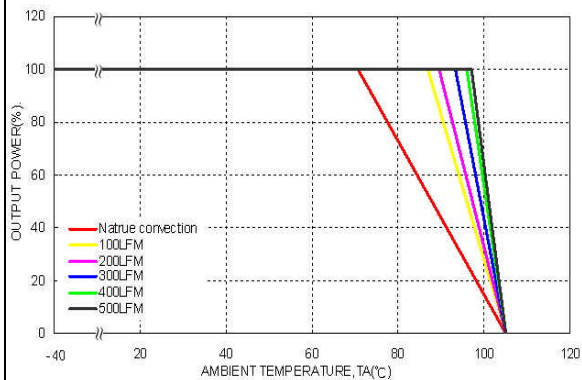

Derating Output Current Versus Ambient Temperature with Heat-Sink
and Airflow, $V_{in} = V_{in(nom)}$

Characteristic Curves (Continued)

All test conditions are at 25 °C. PXB15-24WD15

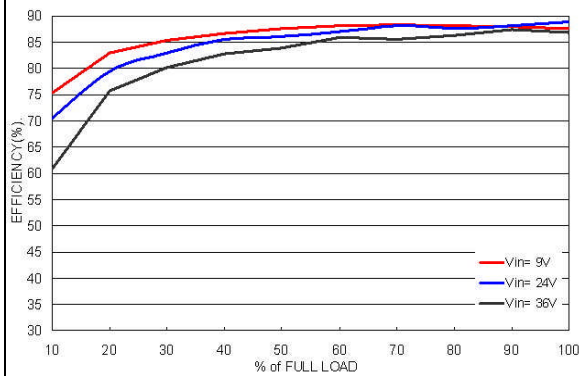

Efficiency versus Output Current

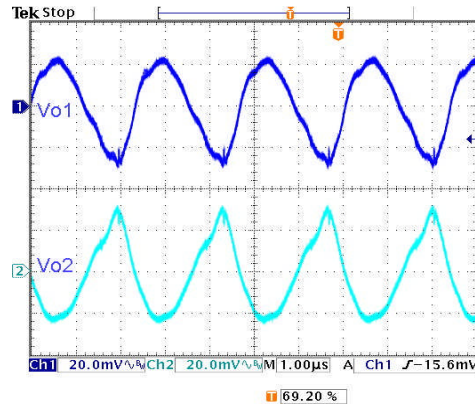

Typical Output Ripple and Noise.
Vin = Vin(nom) ; Full Load

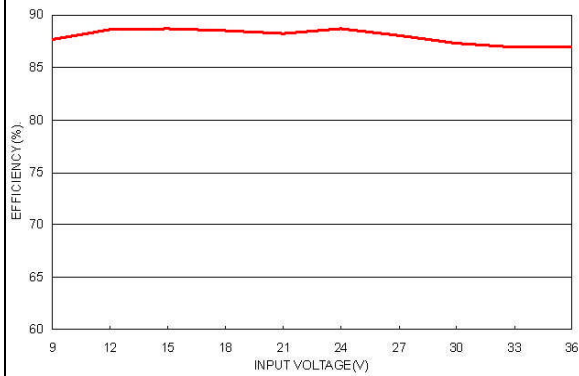

Efficiency versus Input Voltage, Full Load

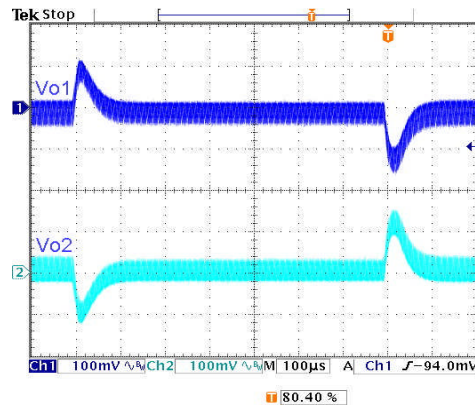

Transient Response to Dynamic Load Change from
100% to 75% to 100% of Full Load ; Vin = Vin(nom)

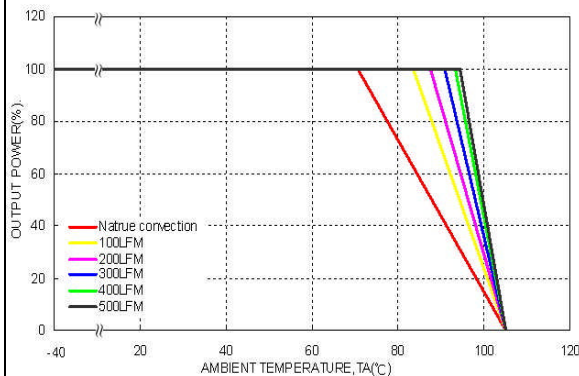

Derating Output Current versus Ambient Temperature and Airflow
Vin = Vin(nom)

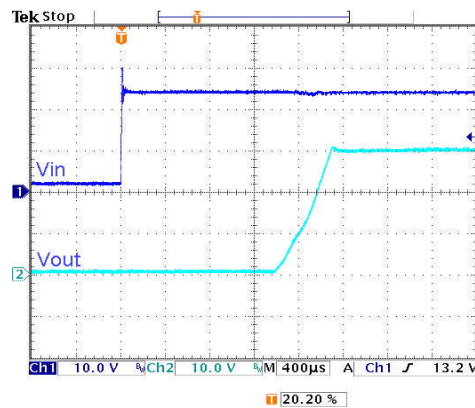

Typical Input Start-Up and Output Rise Characteristic
Vin = Vin(nom) ; Full Load

Characteristic Curves (Continued)

All test conditions are at 25 °C. PXB15-24WD15

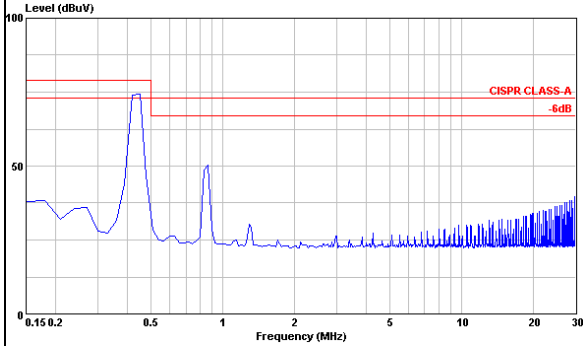

Conduction Emission of EN55022 Class A
 $V_{in} = V_{in(nom)}$; Full Load

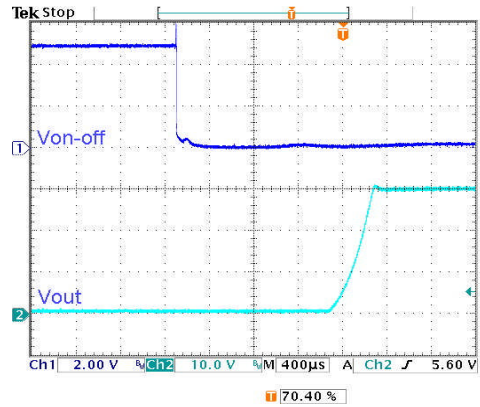

Using ON/OFF Voltage Start-Up and Vo Rise Characteristic
 $V_{in} = V_{in(nom)}$; Full Load

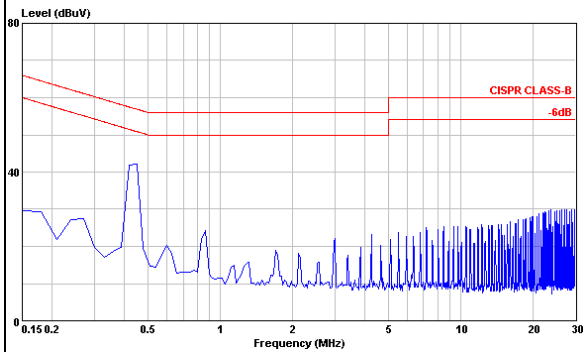

Conduction Emission of EN55022 Class B
 $V_{in} = V_{in(nom)}$; Full Load

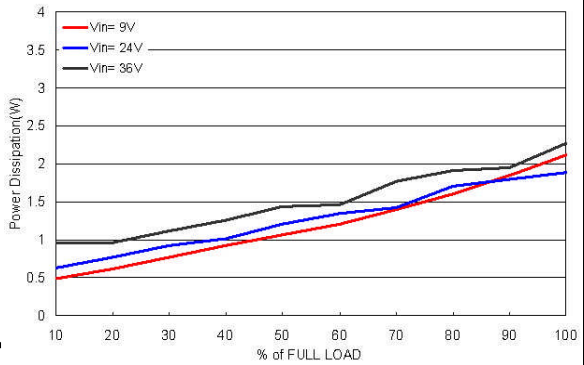

Power Dissipation versus Output Current

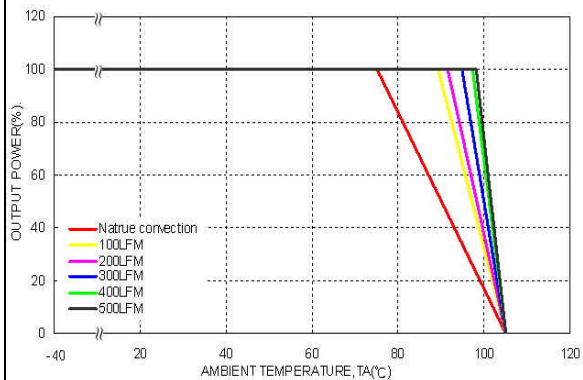

Derating Output Current Versus Ambient Temperature with Heat-Sink and Airflow, $V_{in} = V_{in(nom)}$

Characteristic Curves (Continued)

All test conditions are at 25 °C. PXB15-48WD05

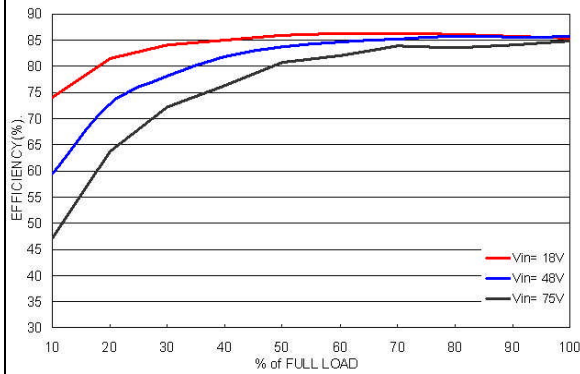

Efficiency versus Output Current

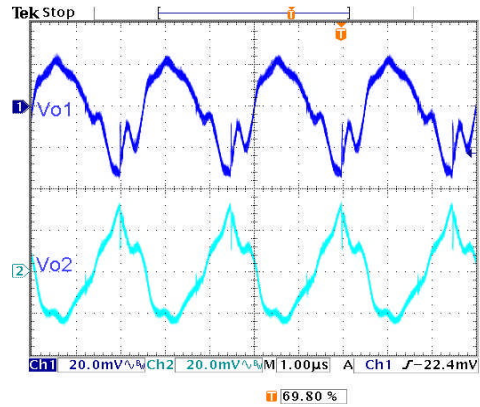

Typical Output Ripple and Noise.
Vin = Vin(nom); Full Load

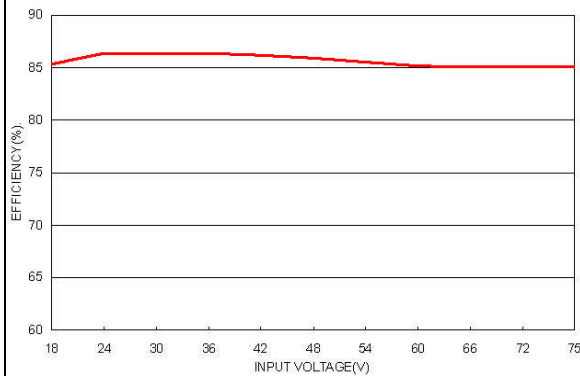

Efficiency versus Input Voltage, Full Load

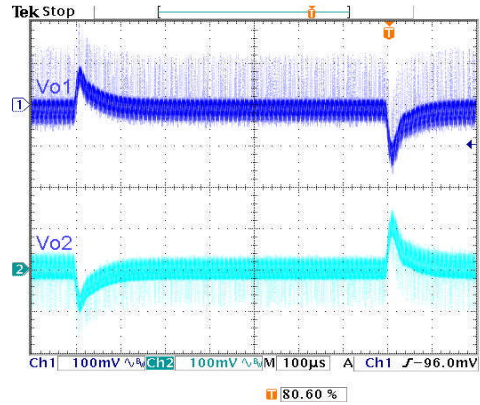

Transient Response to Dynamic Load Change from
100% to 75% to 100% of Full Load ; Vin = Vin(nom)

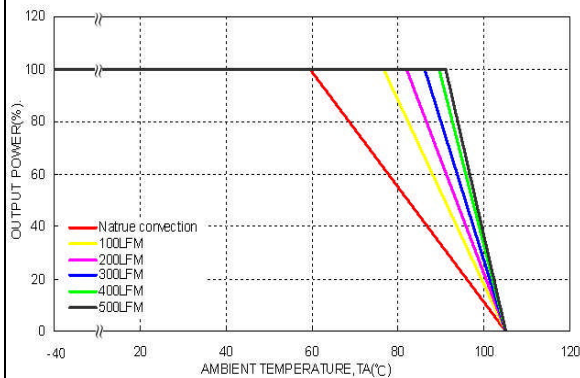

Derating Output Current versus Ambient Temperature and Airflow
Vin = Vin(nom)

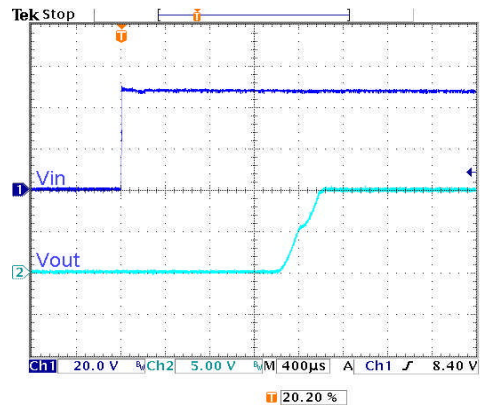

Typical Input Start-Up and Output Rise Characteristic
Vin = Vin(nom) ; Full Load

Characteristic Curves (Continued)

All test conditions are at 25 °C. PXB15-48WD05

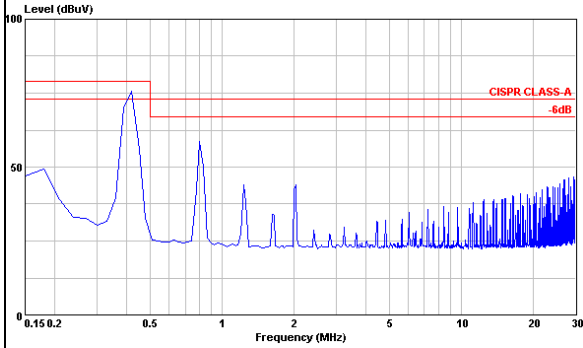

Conduction Emission of EN55022 Class A
 $V_{in} = V_{in(nom)}$; Full Load

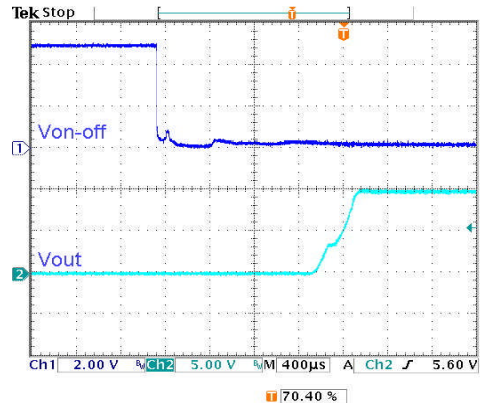

Using ON/OFF Voltage Start-Up and Vo Rise Characteristic
 $V_{in} = V_{in(nom)}$; Full Load

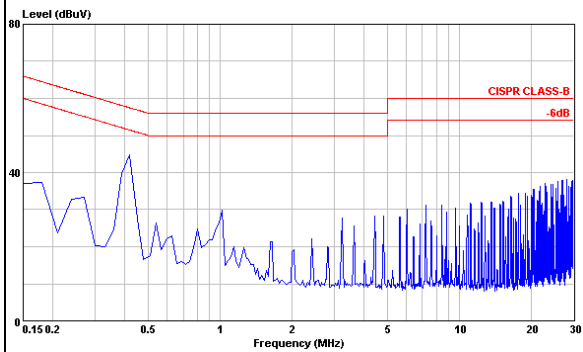

Conduction Emission of EN55022 Class B
 $V_{in} = V_{in(nom)}$; Full Load

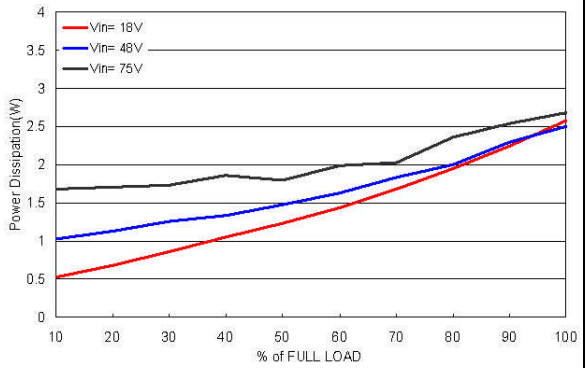

Power Dissipation versus Output Current

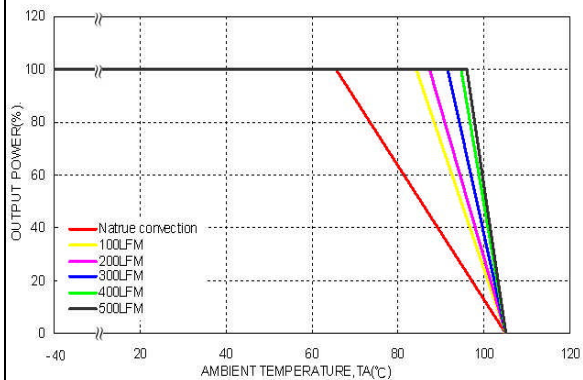

Derating Output Current Versus Ambient Temperature with Heat-Sink and Airflow, $V_{in} = V_{in(nom)}$

Characteristic Curves (Continued)

All test conditions are at 25 °C. PXB15-48WD12

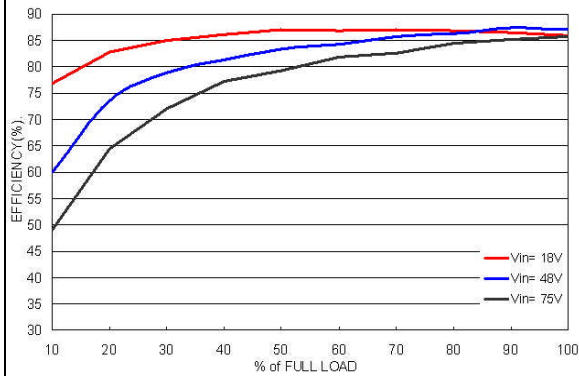

Efficiency versus Output Current

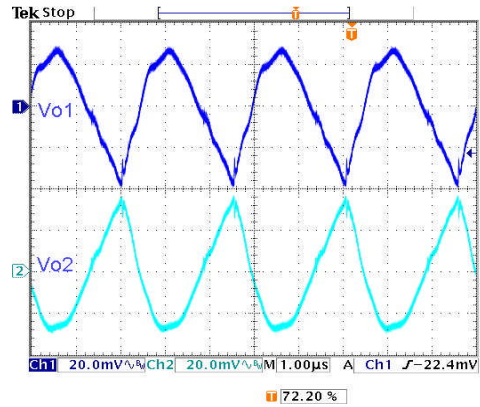

Typical Output Ripple and Noise.
Vin = Vin(nom) ; Full Load

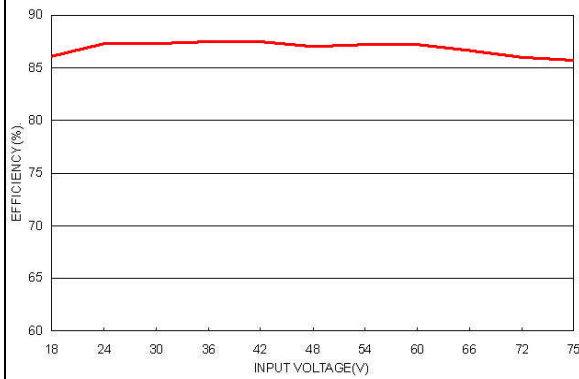

Efficiency versus Input Voltage, Full Load

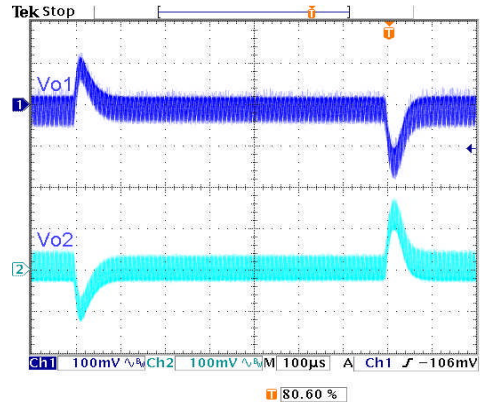

Transient Response to Dynamic Load Change from
100% to 75% to 100% of Full Load ; Vin = Vin(nom)

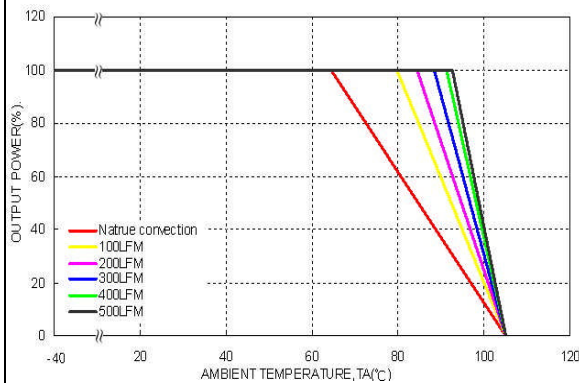

Derating Output Current versus Ambient Temperature and Airflow
Vin = Vin(nom)

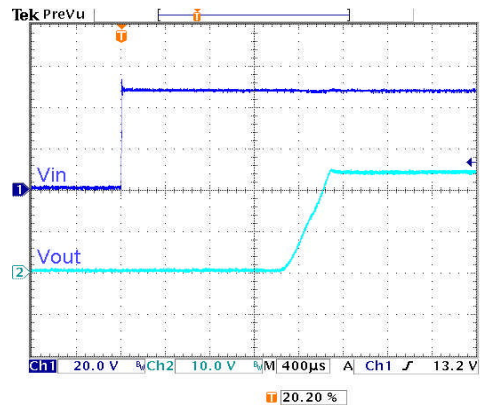

Typical Input Start-Up and Output Rise Characteristic
Vin = Vin(nom) ; Full Load

Characteristic Curves (Continued)

All test conditions are at 25 °C. PXB15-48WD12

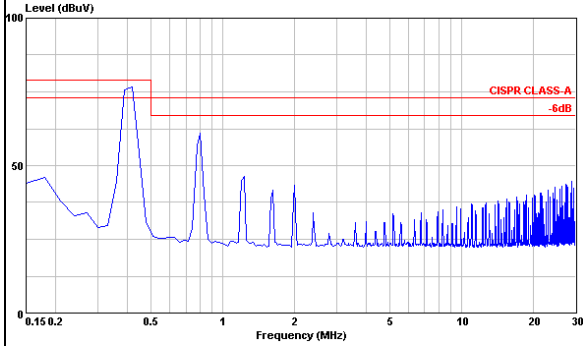

Conduction Emission of EN55022 Class A
 $V_{in} = V_{in(nom)}$; Full Load

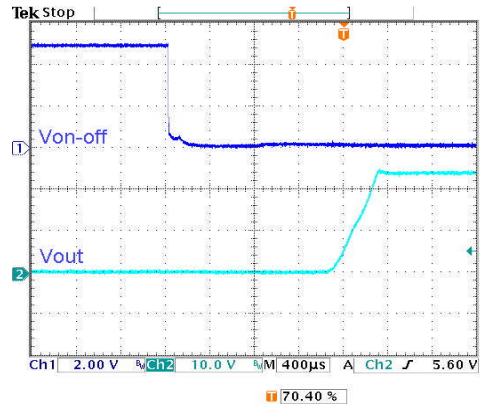

Using ON/OFF Voltage Start-Up and Vo Rise Characteristic
 $V_{in} = V_{in(nom)}$; Full Load

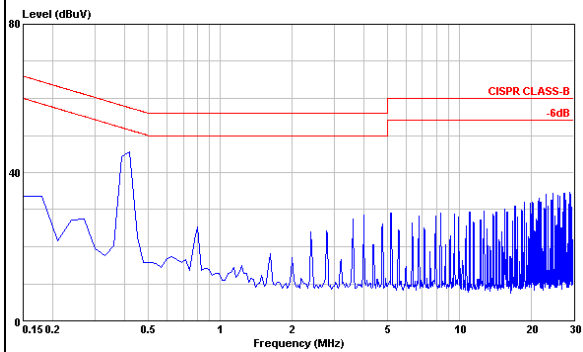

Conduction Emission of EN55022 Class B
 $V_{in} = V_{in(nom)}$; Full Load

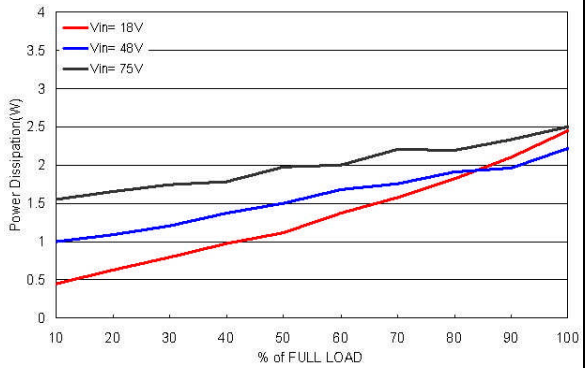

Power Dissipation versus Output Current

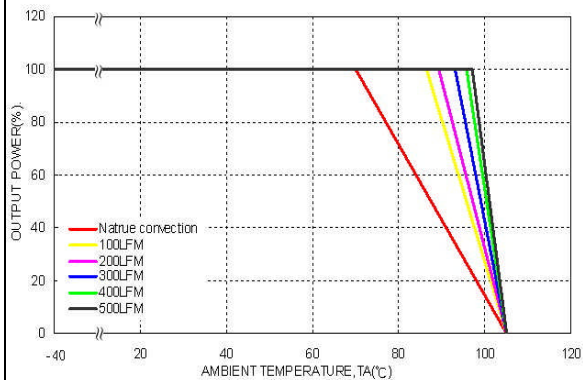

Derating Output Current Versus Ambient Temperature with Heat-Sink and Airflow, $V_{in} = V_{in(nom)}$

Characteristic Curves (Continued)

All test conditions are at 25 °C. PXB15-48WD15

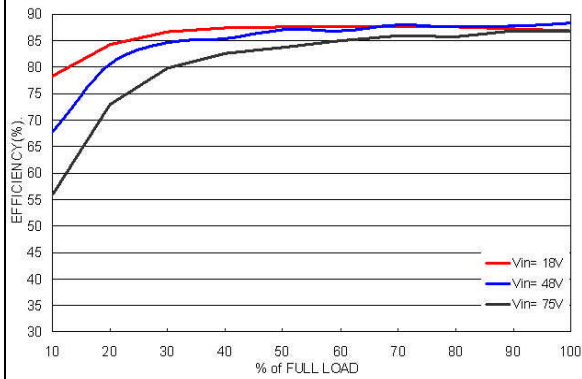

Efficiency versus Output Current

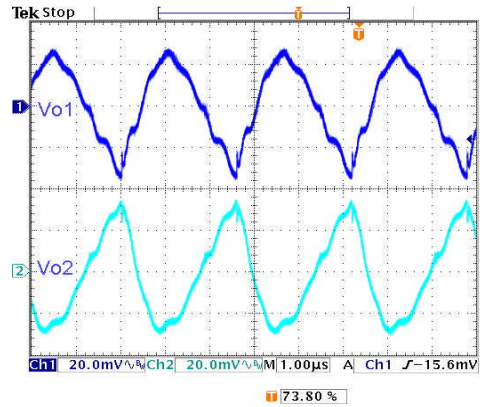

Typical Output Ripple and Noise.
Vin = Vin(nom) ; Full Load

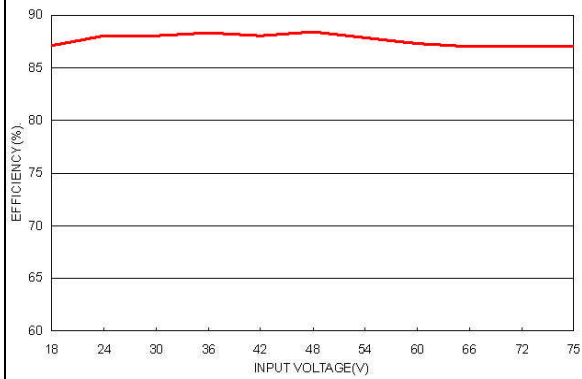

Efficiency versus Input Voltage, Full Load

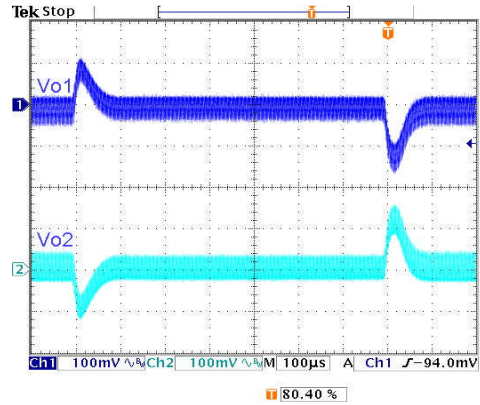

Transient Response to Dynamic Load Change from
100% to 75% to 100% of Full Load ; Vin = Vin(nom)

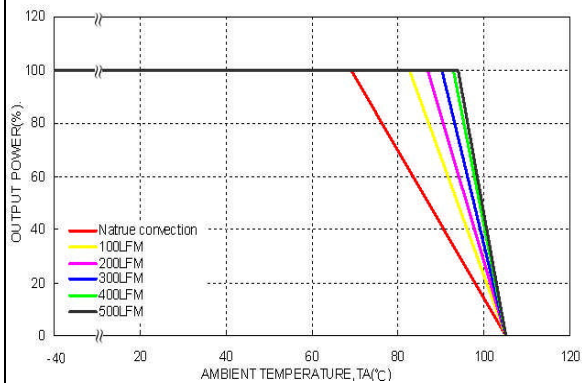

Derating Output Current versus Ambient Temperature and Airflow
Vin = Vin(nom)

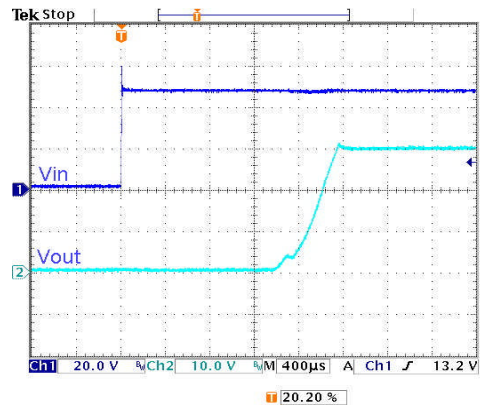

Typical Input Start-Up and Output Rise Characteristic
Vin = Vin(nom) ; Full Load

Characteristic Curves (Continued)

All test conditions are at 25 °C. PXB15-48WD15

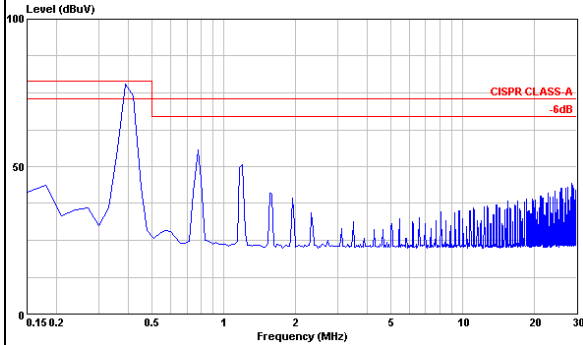

Conduction Emission of EN55022 Class A
 $V_{in} = V_{in(nom)}$; Full Load

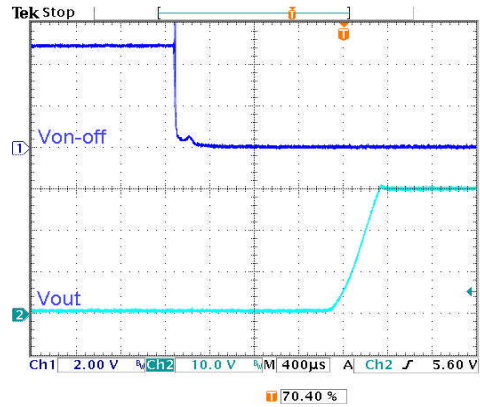

Using ON/OFF Voltage Start-Up and Vo Rise Characteristic
 $V_{in} = V_{in(nom)}$; Full Load

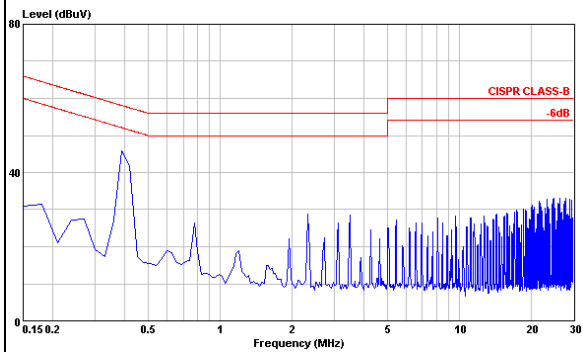

Conduction Emission of EN55022 Class B
 $V_{in} = V_{in(nom)}$; Full Load

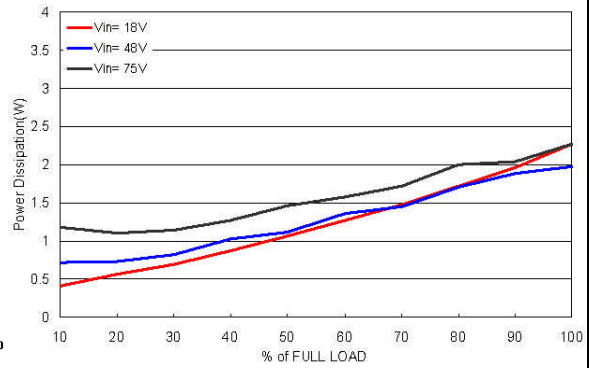

Power Dissipation versus Output Current

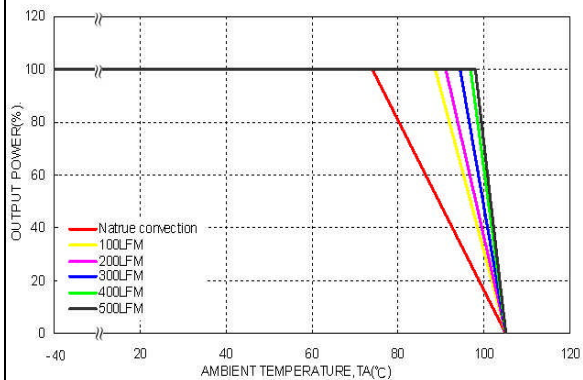

Derating Output Current Versus Ambient Temperature with Heat-Sink
and Airflow, $V_{in} = V_{in(nom)}$

Testing Configurations

Input reflected-ripple current measurement

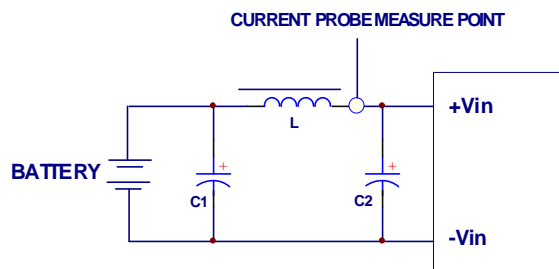

Component	Value	Voltage	Reference
L	12μH	---	---
C1	10μF	100V	Aluminum Electrolytic Capacitor
C2	10μF	100V	Aluminum Electrolytic Capacitor

Peak-to-peak output ripple & noise measurement

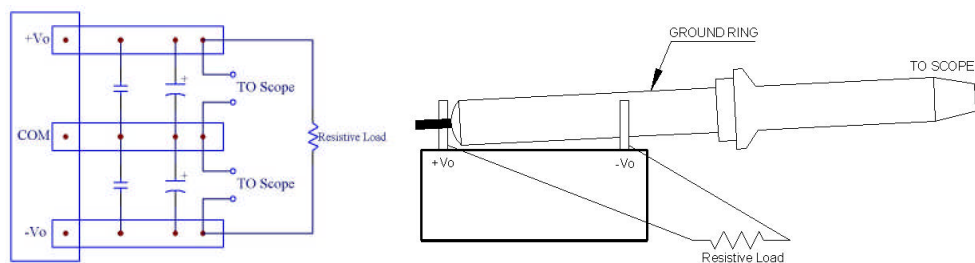

Output voltage and efficiency measurement

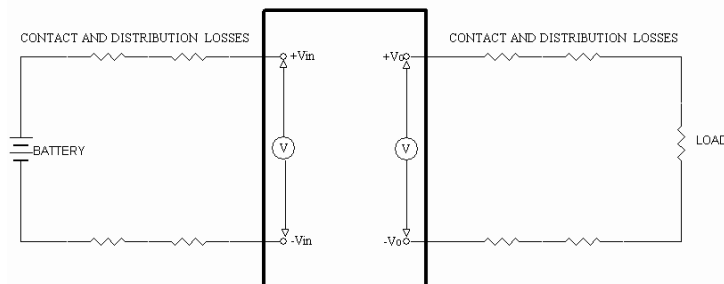

Note: All measurements are taken at the module terminals.

$$\text{Efficiency} = \left(\frac{V_o \times I_o}{V_{in} \times I_{in}} \right) \times 100\%$$

EMC considerations

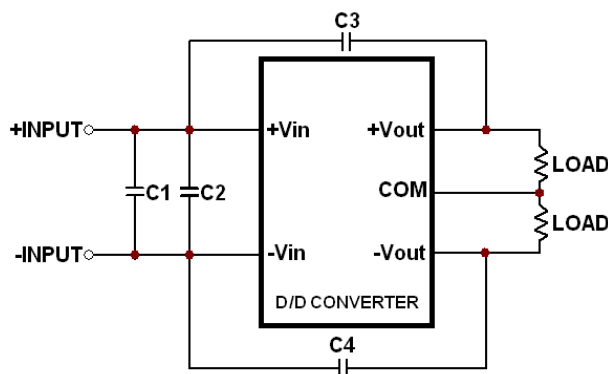

Suggested schematic for EN55022 conducted emission Class A limits

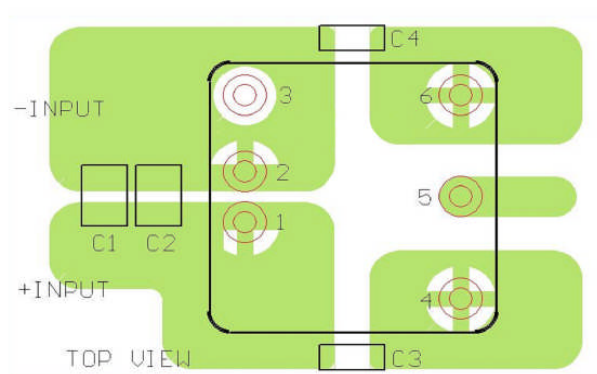

Recommended layout with input filter

To meet conducted emissions EN55022 CLASS A, the following components are needed:

PXB15-24WDXX

Component	Value	Voltage	Reference
C1	6.8uF	50V	1812 MLCC
C2	6.8uF	50V	1812 MLCC
C3,C4	470pF	3KV	1808 MLCC

PXB15-48WDXX

Component	Value	Voltage	Reference
C1	2.2uF	100V	1812 MLCC
C2	2.2uF	100V	1812 MLCC
C3,C4	470pF	3KV	1808 MLCC

EMC considerations (Continued)

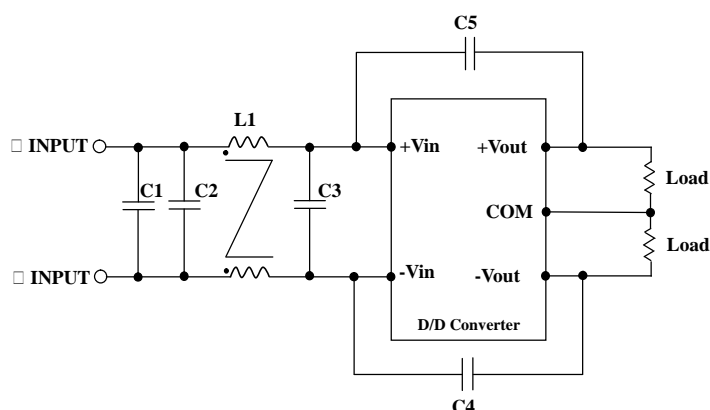

Suggested schematic for EN55022 conducted emission Class B limits

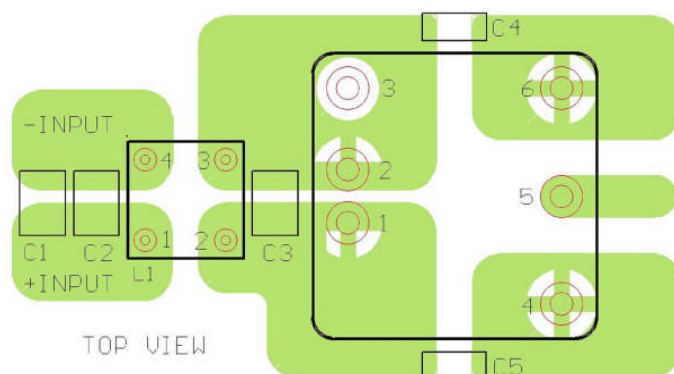

Recommended layout with input filter

To meet conducted emissions EN55022 CLASS B, the following components are needed:

PXB15-24WDXX

Component	Value	Voltage	Reference
C1,C3	6.8 μ F	50V	1812 MLCC
C2	----	----	----
C4,C5	470pF	3KV	1808 MLCC
L1	325 μ H	----	Common Choke

PXB15-48WDXX

Component	Value	Voltage	Reference
C1,C3	2.2 μ F	100V	1812 MLCC
C2	2.2 μ F	100V	1812 MLCC
C4,C5	1000pF	3KV	1808 MLCC
L1	325 μ H	----	Common Choke

Input Source Impedance

The power module should be connected to a low impedance input source. Highly inductive source impedance can affect the stability of the power module. The addition of an external C-L-C filter is recommended to minimize input reflected ripple current. The inductor is simulated source impedance of 12 μ H and capacitor is Nippon chemi-con KZE series 10 μ F/100V&10 μ F/100V. The capacitor must be located as close as possible to the input terminals of the power module for lower impedance.

Output Over Current Protection

When excessive output currents occur in the system, circuit protection is required on all power supplies. Normally, overload current is maintained at approximately 150 percent of rated current for PXB15W Dual output series.

Hiccup-mode is a method of operation in a power supply whose purpose is to protect the power supply from being damaged during an over-current fault condition. It also allows the power supply to restart when the fault is removed.

One of the problems resulting from over current is that excessive heat may be generated in power devices; especially MOSFET and Schottky diodes and the temperature of those devices may exceed their specified limits. A protection mechanism has to be used to prevent those power devices from being damaged.

Output Over Voltage Protection

The output over-voltage protection consists of a Zener diode that monitors the output voltage on the feedback loop. If the voltage on the output terminals exceeds the over-voltage protection threshold, then the Zener diode will send a signal to the control IC to limit the output voltage.

Short Circuit Protection

Continuous, hiccup and auto-recovery mode.
During a short circuit condition the converter will shut down. The average current during this condition will be very low and damage to this device should not occur.

Thermal Consideration

The power module operates in a variety of thermal environments. However, sufficient cooling should be provided to help ensure reliable operation of the unit. Heat is removed by conduction, convection, and radiation to the surrounding Environment. Proper cooling can be verified by measuring the point as shown in the figure below. The temperature at this location should not exceed 105 °C. When Operating, adequate cooling must be provided to maintain the test point temperature at or below 105 °C. Although the maximum point Temperature of the power modules is 105 °C, maintaining a lower operating temperature will increase the reliability of this device.

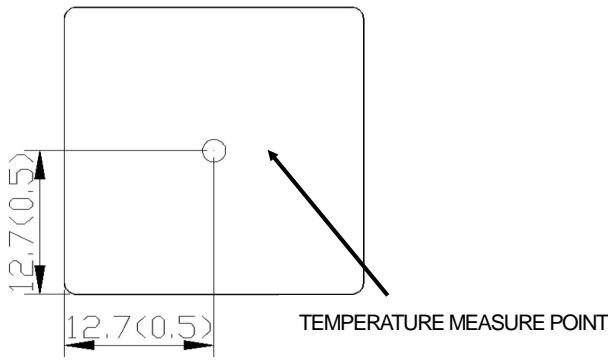

Heat Sink Consideration

The addition of a heat sink may be needed to decrease the temperature of the module; thus increasing its reliability.

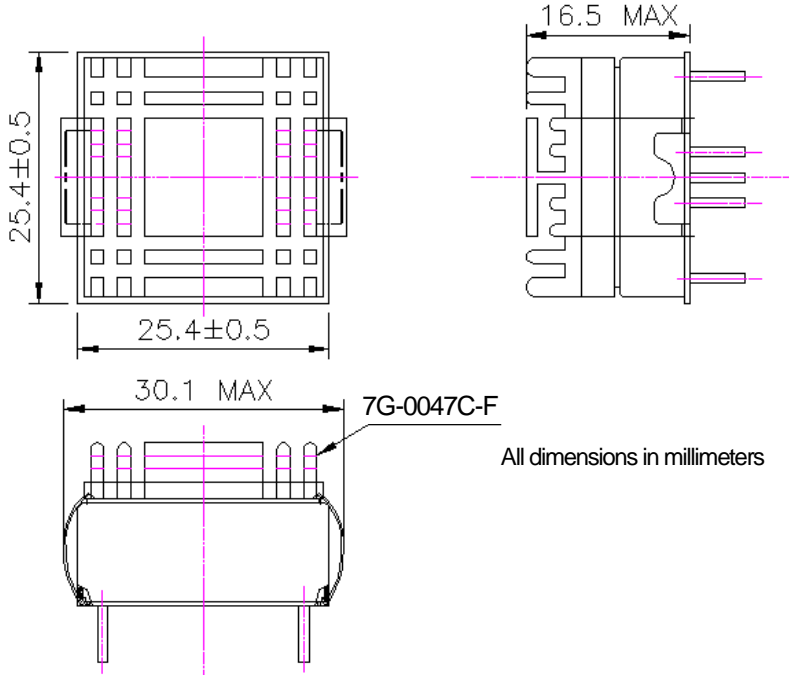

Remote ON/OFF Control

The Remote ON/OFF Pin is used to turn the DC/DC power module on and off. The user must connect a switch between the on/off pin and the Vi (-) pin. The switch can be an open collector transistor, FET, or Photo-Coupler. The switch must be capable of sinking up to 1 mA when using a low logic level voltage. When using a high logic level, the maximum signal voltage is 15V and the maximum allowable leakage current of the switch is 50 uA.

Remote ON/OFF Implementation Circuits

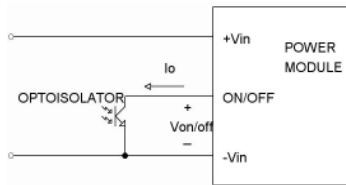

Isolated-Closure Remote ON/OFF

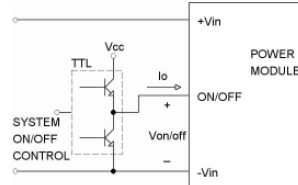

Level Control Using TTL Output

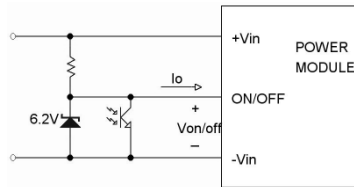

Level Control Using Line Voltage

There are two remote control options available, positive logic and negative logic.

a. Positive logic - The DC/DC module is turned on when the ON/OFF pin is at a high logic level. A low logic signal is needed to turn off the device.

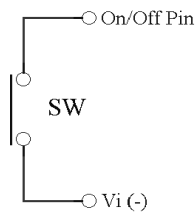

Low logic level

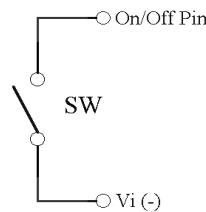

at High logic level

When PXB15W module is turned off at Low logic level

b. Negative logic - The DC/DC module is turned on when the ON/OFF pin is at low logic level. A high logic level signal is needed to turn off the device.

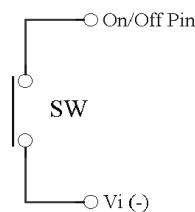

Low logic level

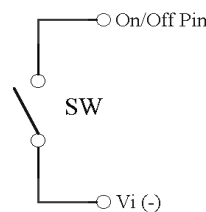

at High logic level

When PXB15W module is turned on at Low logic level

Mechanical Data

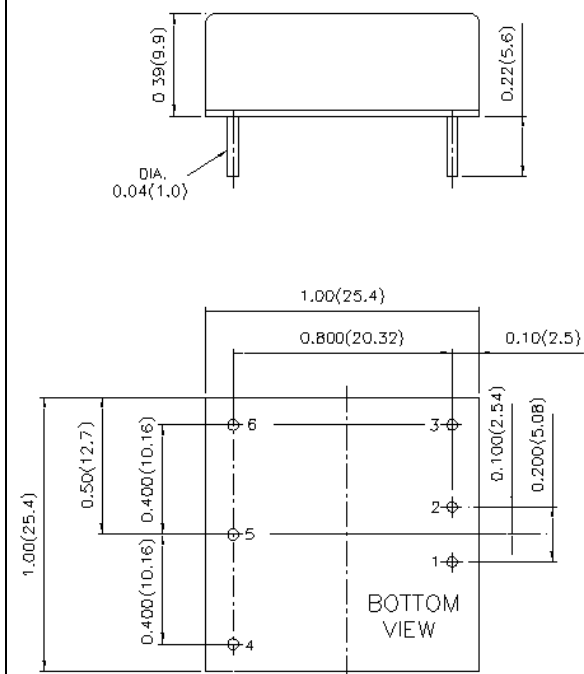

1. All dimensions in Inches (mm)
Tolerance: X.XX±0.02 (X.X±0.5)
X.XXX±0.01 (X.XX±0.25)
2. Pin pitch tolerance ±0.01(0.25)
3. Pin dimension tolerance ±0.004 (0.1)

PIN CONNECTION	
PIN	PXB15-WD Series
1	+ INPUT
2	- INPUT
3	ON/OFF
4	+VOUT
5	COMMON
6	-VOUT

OPTIONS	
Suffix	Description
P	+ INPUT
N	- INPUT
T	ON/OFF

-NT as standard. Delete suffix if not required

Recommended Pad Layout

Recommended Pad Layout

ALL Dimensions in inches (millimeters)

Tolerances:xx.xxx in ± 0.010 in (xx.xx mm ± 0.25 mm)

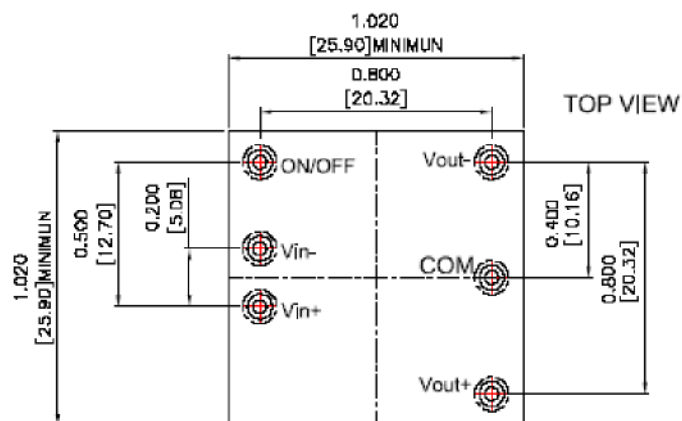

PAD SIZE (LEAD FREE RECOMMENDED)

PIN THROUGH HOLE: ϕ 0.047in(1.2mm)

TOP VIEW PAD: ϕ 0.079in(2.0mm)

BOTTOM VIEW PAD: ϕ 0.118in(3.0mm)

Soldering Considerations

Lead free wave solder profile for PXB15-xxWDxx-SERIES

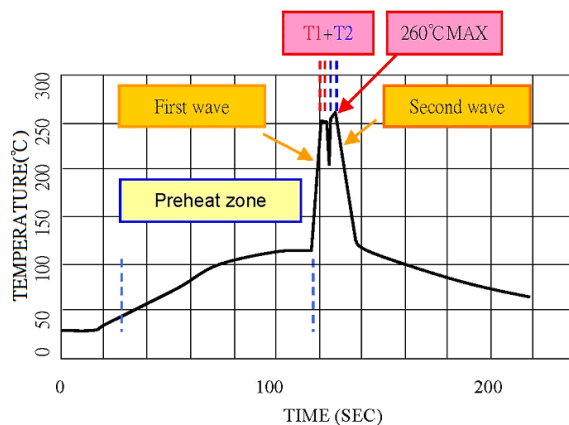

Zone	Reference Parameter.
Preheat zone	Rise temp. speed: 3 °C /sec max. Preheat temp.: 100~130 °C
Actual heating	Peak temp.: 250~260 °C Peak time(T1+T2 time): 4~6 sec

Reference Solder: Sn-Ag-Cu; Sn-Cu

Hand Welding: Soldering iron: Power 90W

Welding Time: 2~4 sec

Temp.: 380~400 °C

Packaging Information

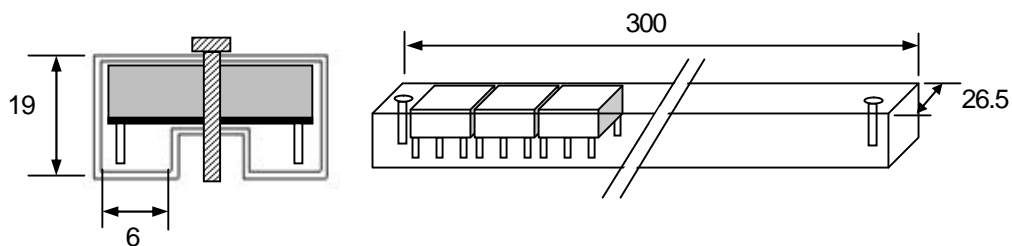

All dimensions in millimeters

10 PCS per TUBE

Part Number Structure

PXB 15 - 24W D 05 -A

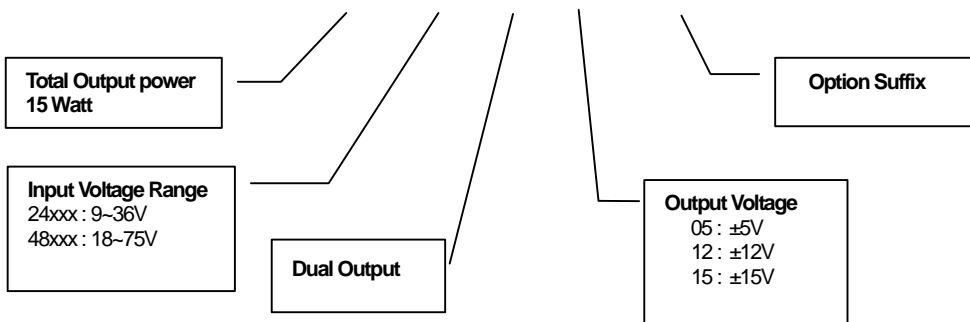

Model Number	Input Range	Output Voltage	Output Current	Input Current	Eff ⁽²⁾ (%)
			Full Load	Full Load ⁽¹⁾	
PXB15-24WD05	9 - 36 VDC	±5VDC	±1500mA	772mA	85
PXB15-24WD12	9 - 36 VDC	±12VDC	±625mA	753mA	87
PXB15-24WD15	9 - 36 VDC	±15VDC	±500mA	744mA	88
PXB15-48WD05	18 - 75 VDC	±5VDC	±1500mA	386mA	85
PXB15-48WD12	18 - 75 VDC	±12VDC	±625mA	382mA	86
PXB15-48WD15	18 - 75 VDC	±15VDC	±500mA	377mA	87

Note 1. Maximum value at nominal input voltage and full load.

Note 2. Typical value at nominal input voltage and full load.

Safety and Installation Instruction

Fusing Consideration

Caution: This power module is not internally fused. An input line fuse must always be used.

This encapsulated power module can be used in a wide variety of applications, ranging from simple stand-alone operation to an integrated part of sophisticated power architecture. For maximum flexibility, internal fusing is not included; however, to achieve maximum safety and system protection, always use an input line fuse. The safety agencies require a normal-blow fuse with maximum rating of 3A for PXB15-24WDXX modules and 1.5A for PXB15-48WDXX modules. Based on the information provided in this data sheet on Inrush energy and maximum DC input current; the same type of fuse with lower rating can be used. Refer to the fuse manufacturer's data for further information.

MTBF and Reliability

The MTBF of PXB15WD SERIES of DC/DC converters has been calculated using

Bellcore TR-NWT-000332 Case I: 50% stress, Operating Temperature at 40 °C (Ground fixed and controlled environment). The resulting figure for MTBF is 1.330×10⁶ hours.

MIL-HDBK 217F NOTICE2 FULL LOAD, Operating Temperature at 25 °C .. The resulting figure for MTBF is 5.630×10⁵ hours.