

ON Semiconductor

Is Now

onsemi™

To learn more about onsemi™, please visit our website at
www.onsemi.com

onsemi and **onsemi** and other names, marks, and brands are registered and/or common law trademarks of Semiconductor Components Industries, LLC dba "**onsemi**" or its affiliates and/or subsidiaries in the United States and/or other countries. **onsemi** owns the rights to a number of patents, trademarks, copyrights, trade secrets, and other intellectual property. A listing of **onsemi** product/patent coverage may be accessed at www.onsemi.com/site/pdf/Patent-Marking.pdf. **onsemi** reserves the right to make changes at any time to any products or information herein, without notice. The information herein is provided "as-is" and **onsemi** makes no warranty, representation or guarantee regarding the accuracy of the information, product features, availability, functionality, or suitability of its products for any particular purpose, nor does **onsemi** assume any liability arising out of the application or use of any product or circuit, and specifically disclaims any and all liability, including without limitation special, consequential or incidental damages. Buyer is responsible for its products and applications using **onsemi** products, including compliance with all laws, regulations and safety requirements or standards, regardless of any support or applications information provided by **onsemi**. "Typical" parameters which may be provided in **onsemi** data sheets and/or specifications can and do vary in different applications and actual performance may vary over time. All operating parameters, including "Typicals" must be validated for each customer application by customer's technical experts. **onsemi** does not convey any license under any of its intellectual property rights nor the rights of others. **onsemi** products are not designed, intended, or authorized for use as a critical component in life support systems or any FDA Class 3 medical devices or medical devices with a same or similar classification in a foreign jurisdiction or any devices intended for implantation in the human body. Should Buyer purchase or use **onsemi** products for any such unintended or unauthorized application, Buyer shall indemnify and hold **onsemi** and its officers, employees, subsidiaries, affiliates, and distributors harmless against all claims, costs, damages, and expenses, and reasonable attorney fees arising out of, directly or indirectly, any claim of personal injury or death associated with such unintended or unauthorized use, even if such claim alleges that **onsemi** was negligent regarding the design or manufacture of the part. **onsemi** is an Equal Opportunity/Affirmative Action Employer. This literature is subject to all applicable copyright laws and is not for resale in any manner. Other names and brands may be claimed as the property of others.

NCP582

Ultra-Fast, Low Noise 150 mA CMOS LDO Regulator with Enable

The NCP582 series of low dropout regulators are designed for portable battery powered applications which require precise output voltage accuracy, low quiescent current, and high ripple rejection. These devices feature an enable function and are offered in active low and active high with auto discharge.

The following ceramic capacitors are the recommended values to be used with these devices; for $V_{out} < 2.5$ V, $C_{in} = C_{out} = 1.0$ μ F, $V_{out} \geq 2.5$ V, $C_{in} = C_{out} = 0.47$ μ F.

Features

- Ultra-Low Dropout Voltage of 220 mV at 150 mA
- Low Output Noise of 30 μ Vrms without Noise Reduction Cap
- Excellent Line Regulation of 0.02%/V
- Excellent Load Regulation of 22 mV
- High Output Voltage Accuracy of $\pm 2\%$
- Low Iq Current of 75 μ A
- Very Low Shutdown Current
- Excellent Power Supply Rejection Ratio of 70 dB at $f = 1.0$ kHz
- Wide Output Voltage Range of 1.5 V to 3.3 V
- Fast Dynamic Performance
- Fold Back Protection Circuit
- Low Temperature Drift Coefficient on the Output Voltage of ± 100 ppm/ $^{\circ}$ C
- Input Voltage up to 6.5 V
- These are Pb-Free Devices

Typical Applications

- Portable Equipment
- Hand-Held Instrumentation
- Camcorders and Cameras

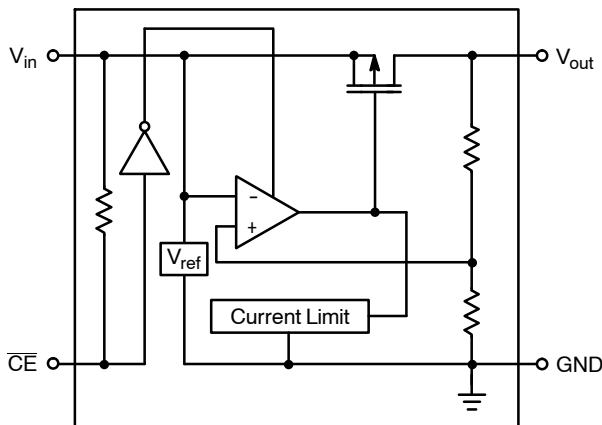

Figure 1. Simplified Block Diagram for Active Low

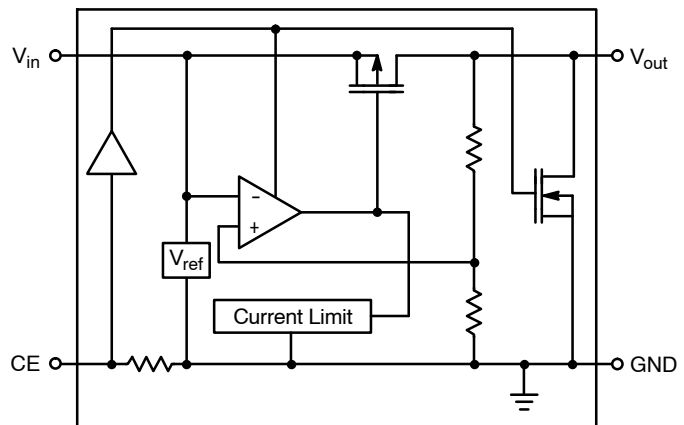

Figure 2. Simplified Block Diagram for Active High with Auto Discharge



ON Semiconductor®

<http://onsemi.com>

MARKING DIAGRAMS

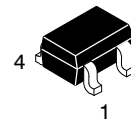

SC-82AB
SQ SUFFIX
CASE 419C

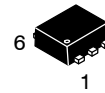
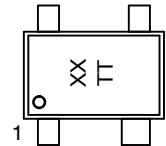

SOT-563
XV SUFFIX
CASE 463A

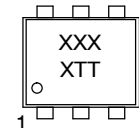

X = Device Code
T = Traceability Information

ORDERING INFORMATION

See detailed ordering and shipping information in the package dimensions section on page 10 of this data sheet.

NCP582

PIN FUNCTION DESCRIPTION

SOT-563 Pin	SC-82AB Pin	Symbol	Description
1	4	V _{in}	Power supply input voltage.
2	2	GND	Power supply ground.
3	3	V _{out}	Regulated output voltage.
4	–	NC	No connect.
5	–	GND	Power supply ground.
6	1	$\overline{\text{CE}}$ or CE	Chip enable pin.

MAXIMUM RATINGS

Rating	Symbol	Value	Unit
Input Voltage	V _{in}	6.5	V
Input Voltage ($\overline{\text{CE}}$ or CE Pin)	V _{CE}	–0.3 to V _{in} + 0.3	V
Output Voltage	V _{out}	–0.3 to V _{in} + 0.3	V
Output Current	I _{out}	200	mA
Power Dissipation SC-82AB SOT-563	P _D	150 500	mW
ESD Capability, Human Body Model, C = 100 pF, R = 1.5 k Ω	ESD _{HBM}	2000	V
ESD Capability, Machine Model, C = 200 pF, R = 0 Ω	ESD _{MM}	200	V
Operating Ambient Temperature Range	T _A	–40 to +85	°C
Maximum Junction Temperature	T _{J(max)}	125	°C
Storage Temperature Range	T _{stg}	–55 to +150	°C

Stresses exceeding Maximum Ratings may damage the device. Maximum Ratings are stress ratings only. Functional operation above the Recommended Operating Conditions is not implied. Extended exposure to stresses above the Recommended Operating Conditions may affect device reliability.

ELECTRICAL CHARACTERISTICS (V_{in} = V_{out} + 1.0 V, T_A = 25°C, unless otherwise noted.)

Characteristic	Symbol	Min	Typ	Max	Unit
Input Voltage	V _{in}	2.0	–	6.0	V
Output Voltage (I _{out} = 1.0 mA to 30 mA)	V _{out}	V _{out} X 0.980	–	V _{out} X 1.020	V
Line Regulation (I _{out} = 30 mA), (V _{out} > 1.7 V; V _{out} + 0.5 V ≤ V _{in} ≤ 6.0 V) (V _{out} = 1.5 V; 2.2 V ≤ V _{in} ≤ 6.0 V)	Reg _{line}	–	0.02	0.10	%/V
Load Regulation (I _{out} = 1.0 mA to 150 mA)	Reg _{load}	–	22	40	mV
Dropout Voltage (I _{out} = 150 mA) V _{out} = 1.5 V V _{out} = 1.8 V V _{out} = 2.5 V 2.8 V ≤ V _{out} ≤ 3.3 V	V _{DO}	–	0.38 0.32 0.28 0.22	0.70 0.55 0.50 0.35	V
Quiescent Current (I _{out} = 0 mA)	I _q	–	75	95	μA
Output Current	I _{out}	150	–	–	mA
Shutdown Current (V _{CE} = Gnd for Active High with Auto Discharge) (V _{CE} = V _{in} for Active Low)	I _{SD}	–	0.1	1.0	μA
Output Short Circuit Current (V _{out} = 0)	I _{lim}	–	40	–	mA
Ripple Rejection (I _{out} = 30 mA) (V _{out} > 1.7 V; V _{in} – V _{out} = 1.0 V) (V _{out} = 1.5 V; V _{in} – V _{out} = 1.2 V) f = 1.0 kHz f = 10 kHz	RR	–	70 60	–	dB
Enable Input Threshold Voltage High Low	V _{th_{enh}} V _{th_{enl}}	1.5 0	– –	V _{in} 0.3	V
Output Noise Voltage (Bandwidth = 10 Hz to 100 kHz)	V _n	–	30	–	μV _{rms}
Output Voltage Temperature Coefficient (I _{out} = 30 mA, –40°C ≤ T _A ≤ 85°C)	ΔV _{out} /ΔT	–	± 100	–	ppm/°C
N-Channel On Resistance for Auto Discharge	R _{Low}	–	60	–	Ω

TYPICAL CHARACTERISTICS

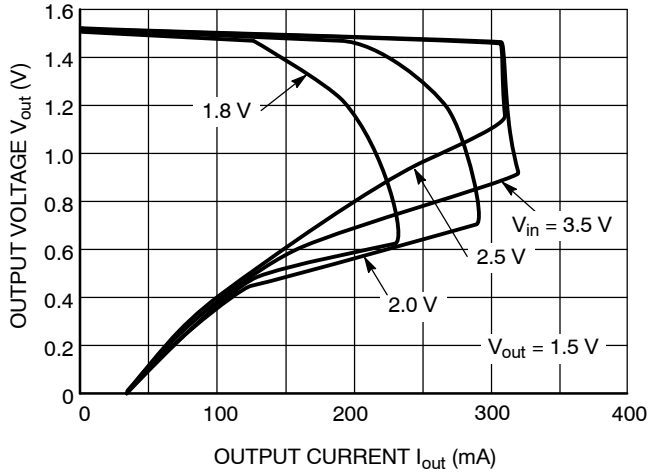

Figure 3. Output Voltage vs. Output Current

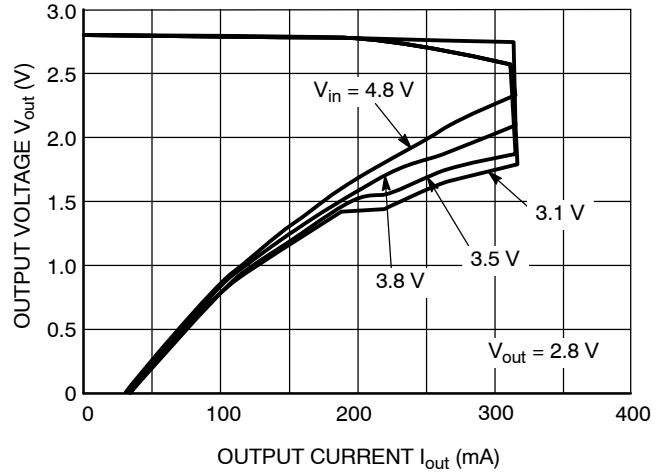

Figure 4. Output Voltage vs. Output Current

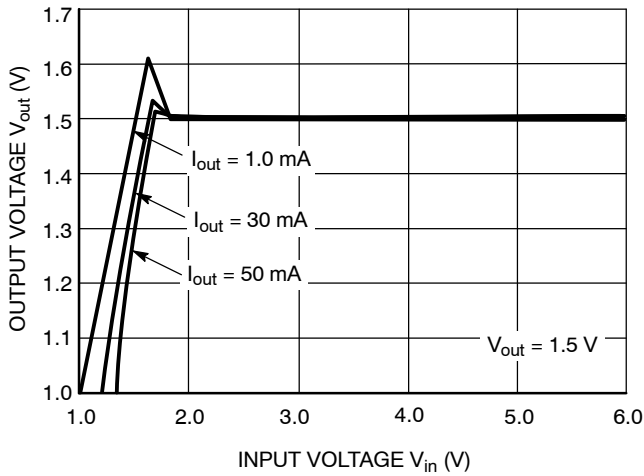

Figure 5. Output Voltage vs. Input Voltage

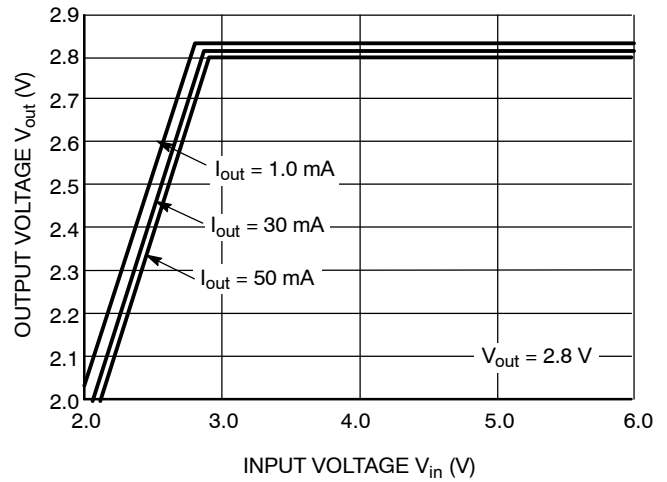

Figure 6. Output Voltage vs. Input Voltage

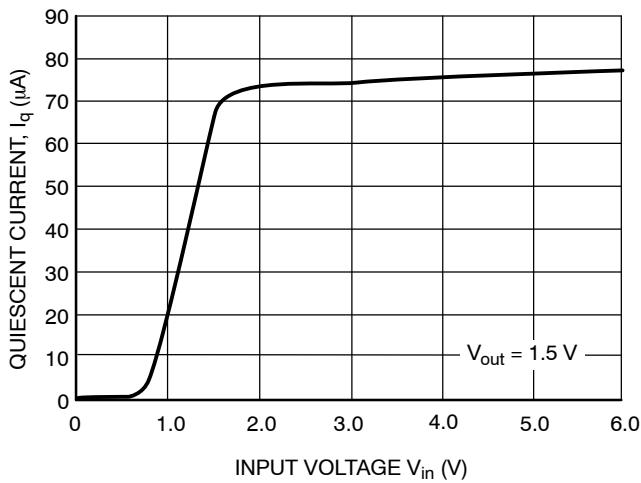

Figure 7. Quiescent Current vs. Input Voltage

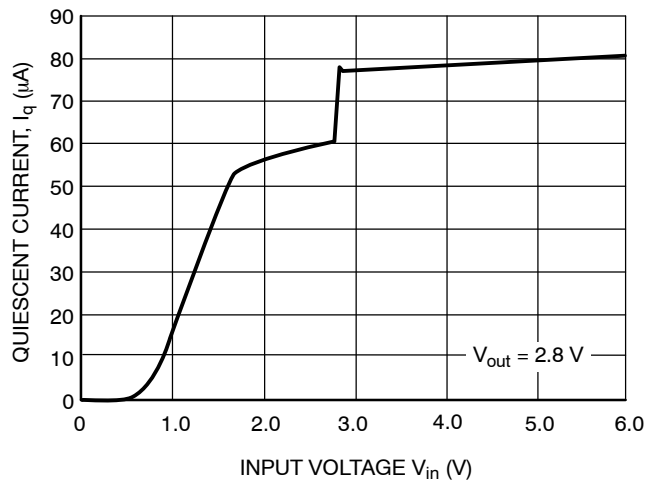

Figure 8. Quiescent Current vs. Input Voltage

TYPICAL CHARACTERISTICS

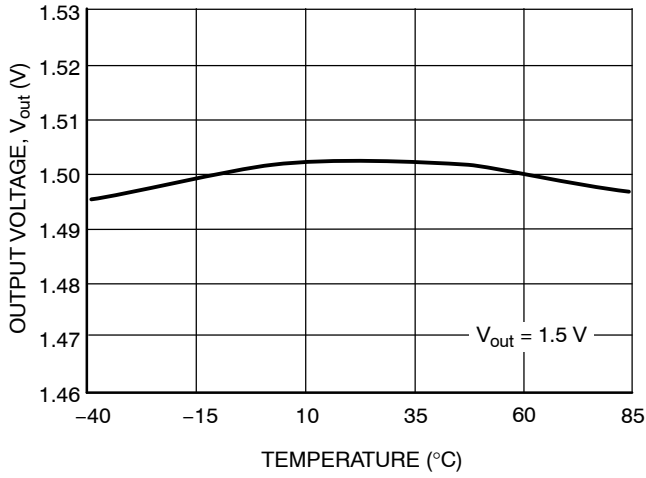

Figure 9. Output Voltage vs. Temperature

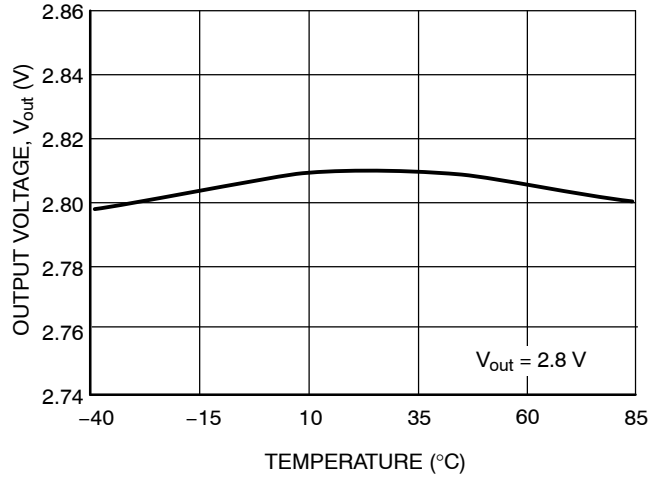

Figure 10. Output Voltage vs. Temperature

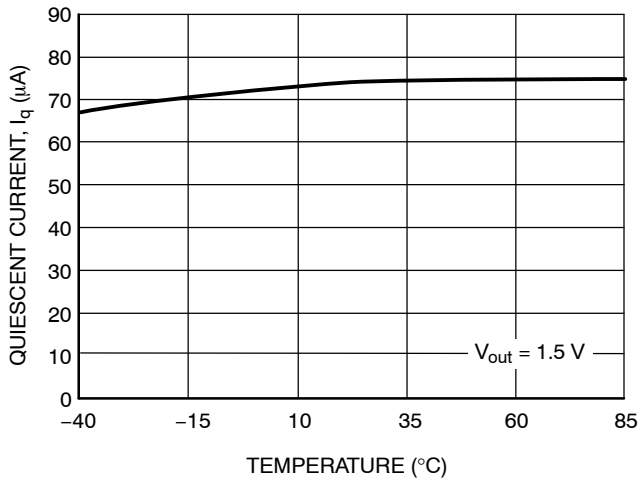

Figure 11. Quiescent Current vs. Temperature

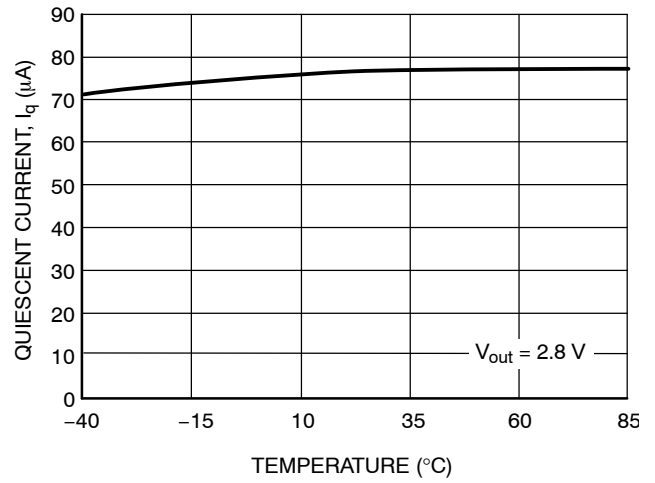

Figure 12. Quiescent Current vs. Temperature

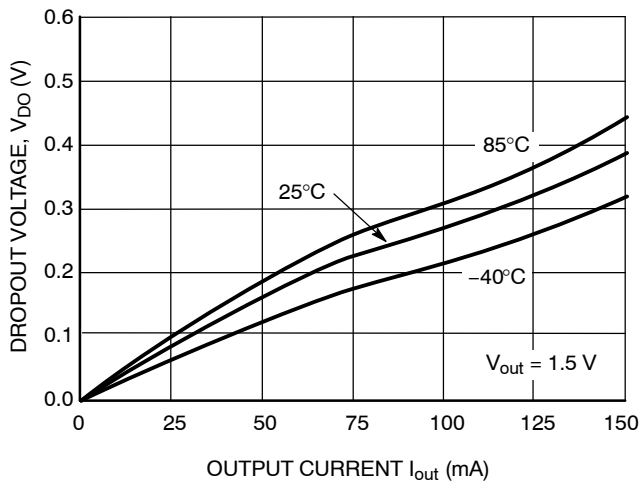

Figure 13. Dropout Voltage vs. Output Current

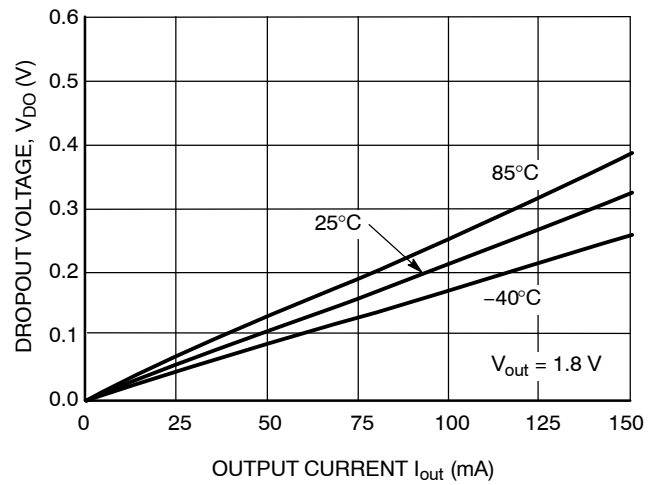

Figure 14. Dropout Voltage vs. Output Current

TYPICAL CHARACTERISTICS

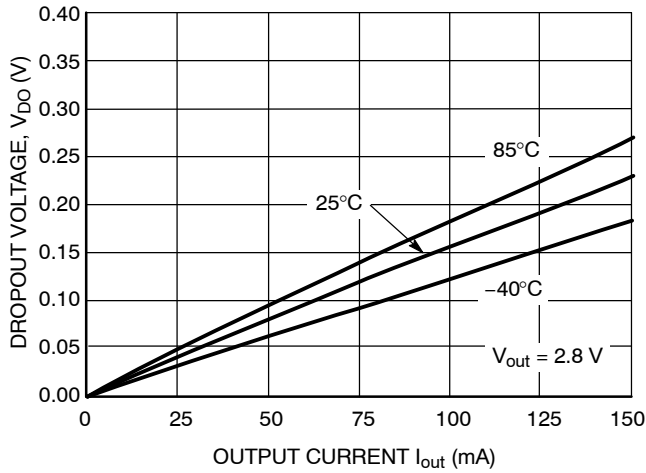

Figure 15. Dropout Voltage vs. Output Current

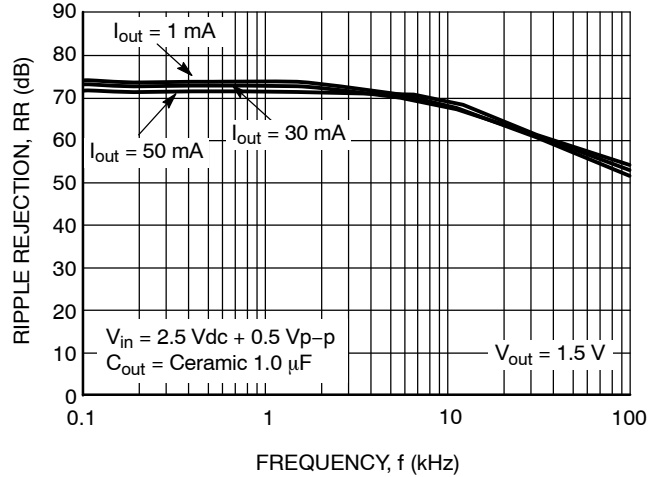

Figure 16. Ripple Rejection vs. Frequency

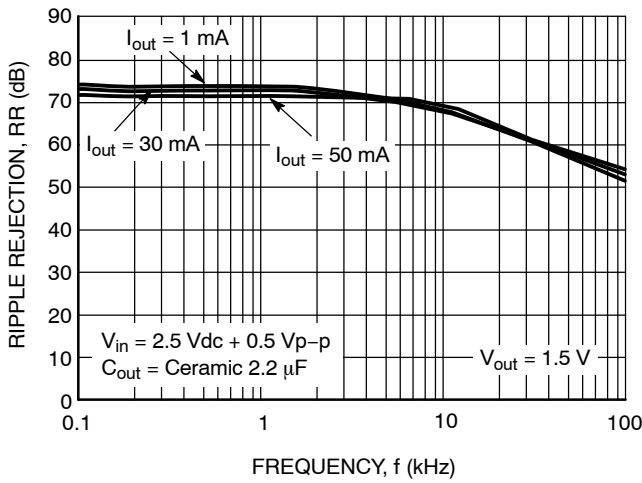

Figure 17. Ripple Rejection vs. Frequency

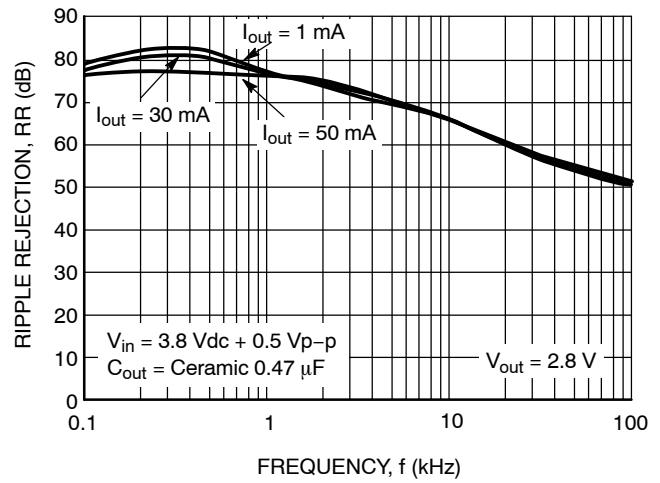

Figure 18. Ripple Rejection vs. Frequency

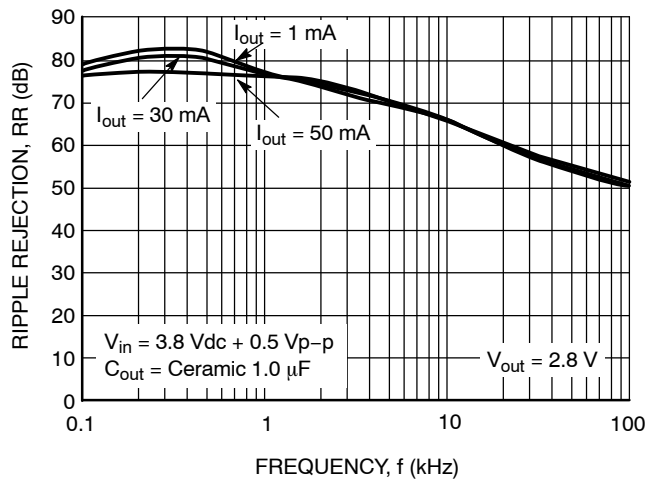

Figure 19. Ripple Rejection vs. Frequency

NCP582

TYPICAL CHARACTERISTICS

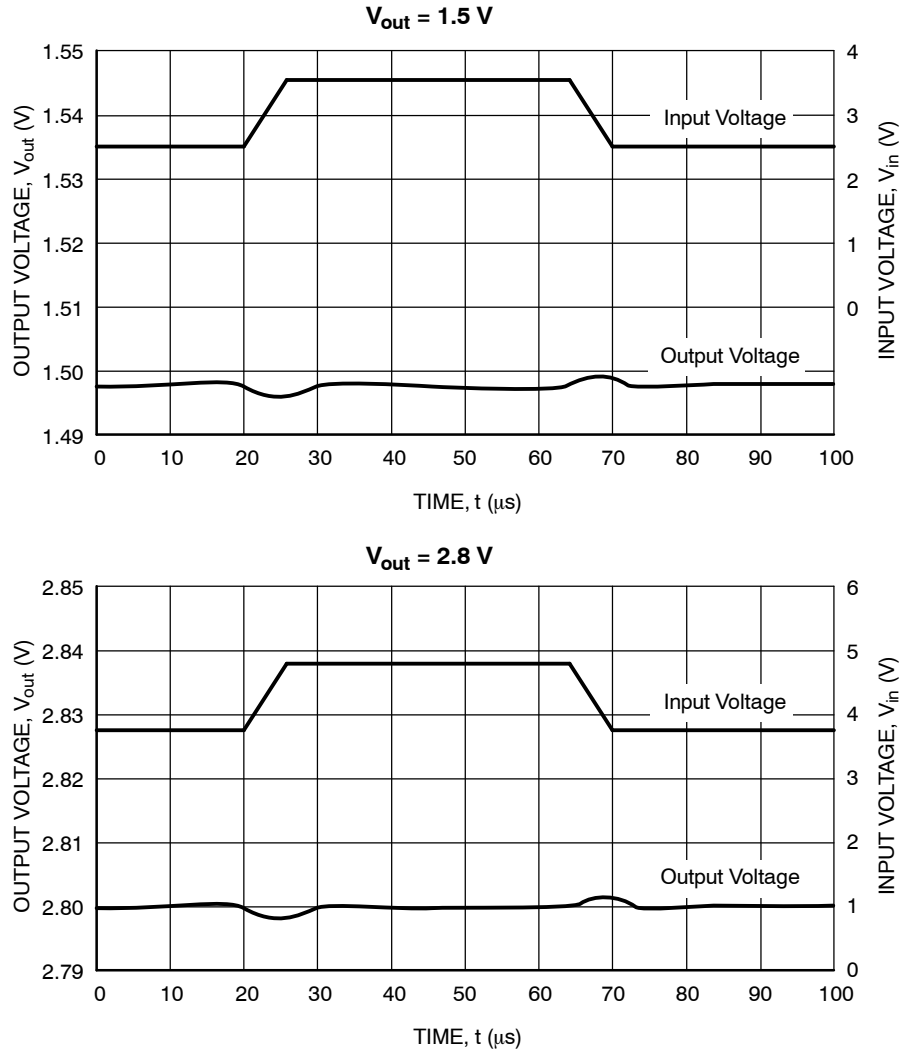
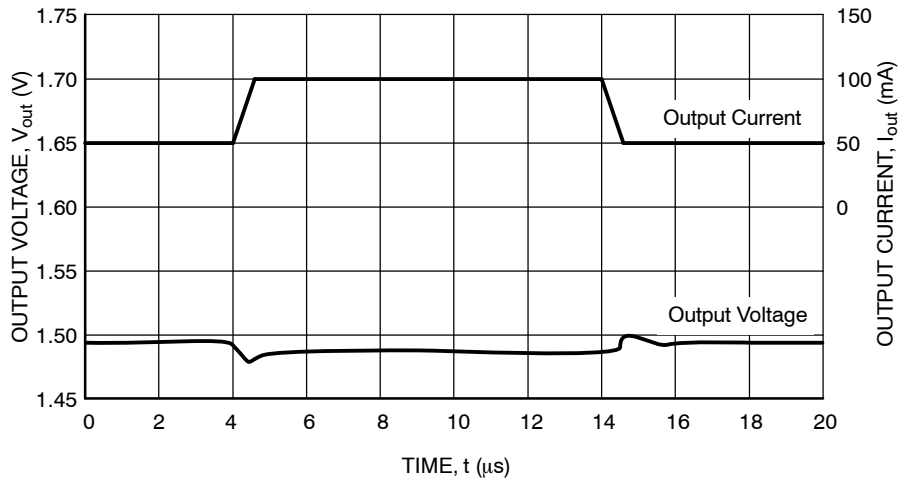

Figure 20. Input Transient Response
($I_{out} = 30\text{ mA}$, $C_{in} = 0$, $t_r = t_f = 5.0\text{ }\mu\text{s}$, $C_{out} = 0.47\text{ }\mu\text{F}$)

NCP582

TYPICAL CHARACTERISTICS

($V_{in} = 2.5\text{ V}$, $C_{out} = 1.0\ \mu\text{F}$, $V_{out} = 1.5\text{ V}$)



($V_{in} = 2.5\text{ V}$, $C_{out} = 2.2\ \mu\text{F}$, $V_{out} = 1.5\text{ V}$)

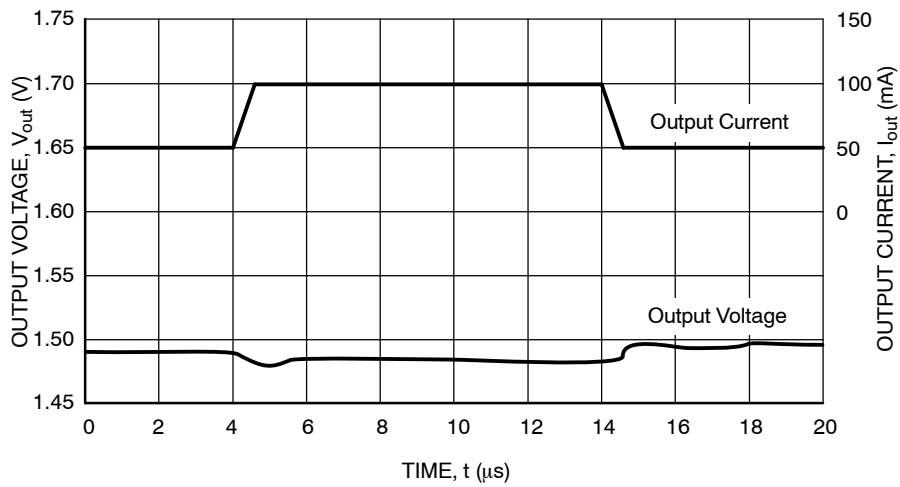
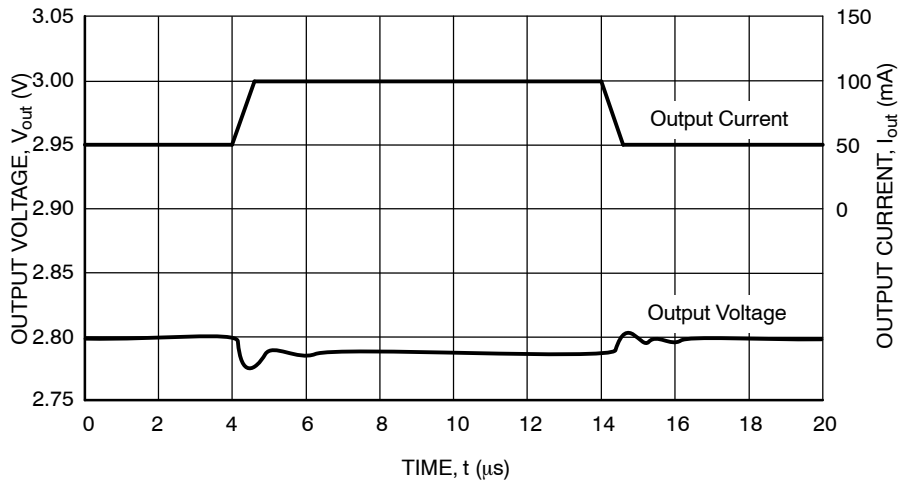

Figure 21. Load Transient Response
($t_r = t_f = 0.5\ \mu\text{s}$, $C_{in} = 1.0\ \mu\text{F}$)

NCP582

TYPICAL CHARACTERISTICS

($V_{in} = 3.8\text{ V}$, $C_{out} = 0.47\text{ }\mu\text{F}$, $V_{out} = 2.8\text{ V}$)



($V_{in} = 3.8\text{ V}$, $C_{out} = 1.0\text{ }\mu\text{F}$, $V_{out} = 2.8\text{ V}$)

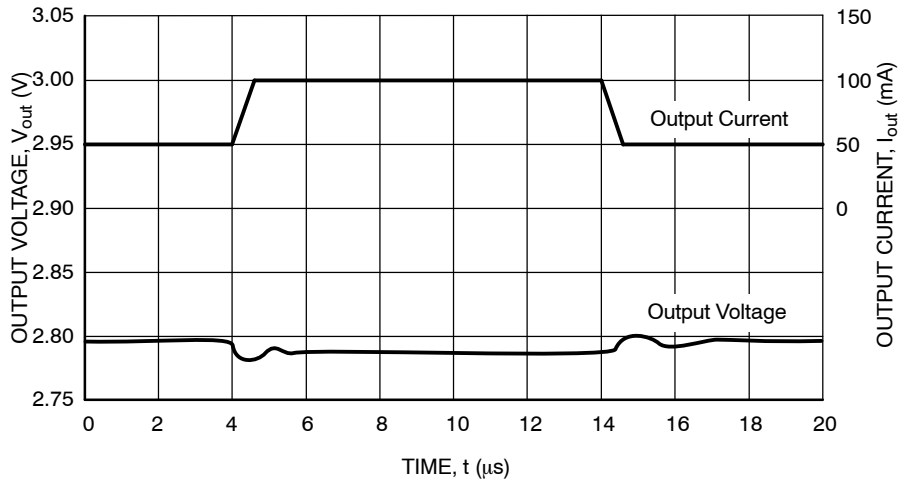

($V_{in} = 3.8\text{ V}$, $C_{out} = 2.2\text{ }\mu\text{F}$, $V_{out} = 2.8\text{ V}$)

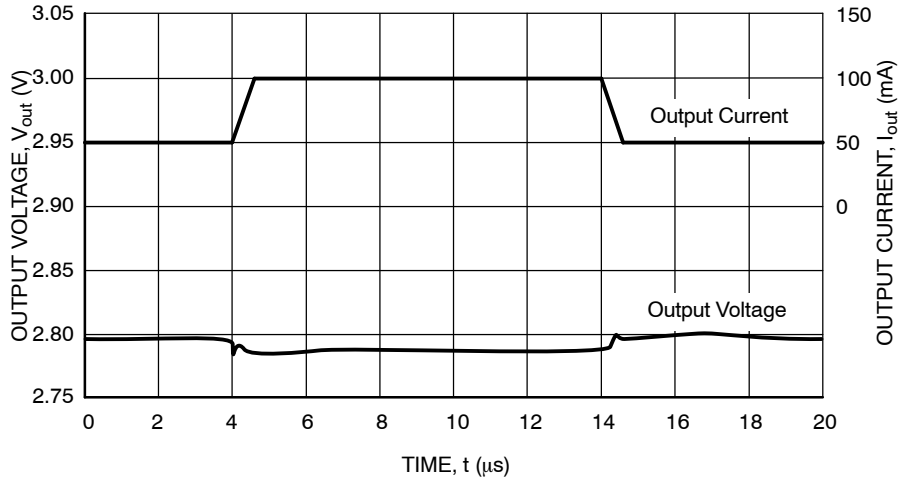

Figure 22. Load Transient Response
($t_r = t_f = 0.5\text{ }\mu\text{s}$, $C_{in} = 1.0\text{ }\mu\text{F}$)

NCP582

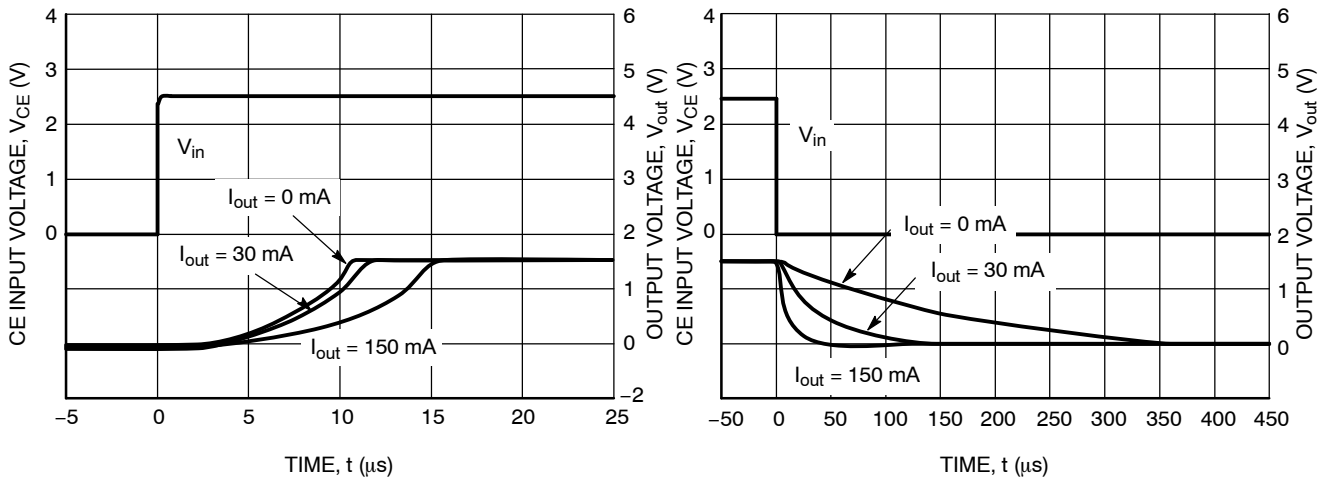

Figure 23. Turn-On/Off Speed with CE Pin (D Version)
 ($V_{out} = 1.5$ V, $V_{in} = 2.5$ V, $C_{in} = 1.0$ μ F, $C_{out} = 1.0$ μ F)

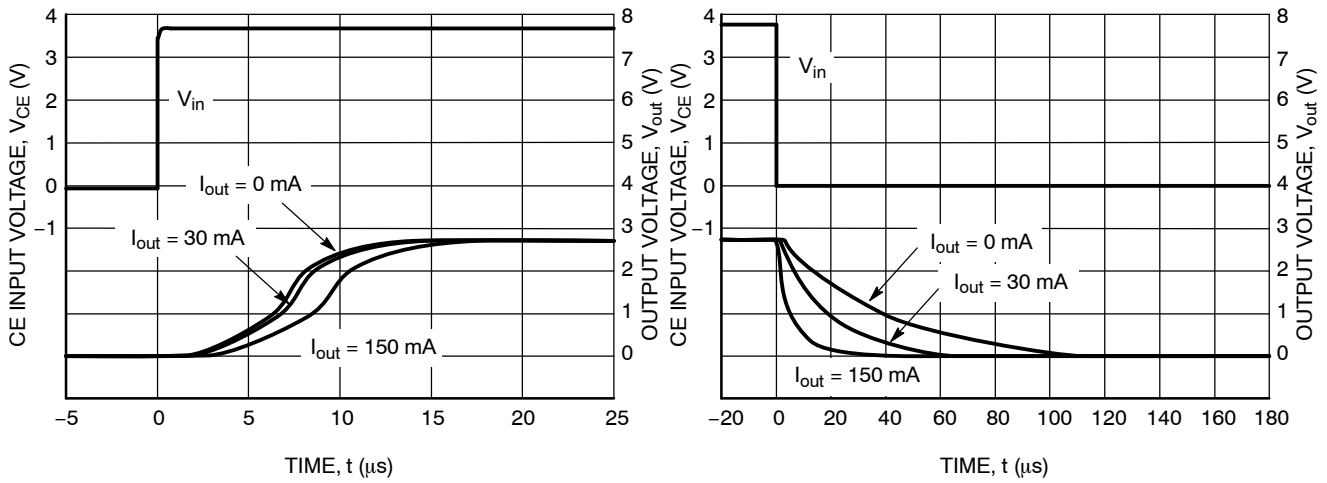

Figure 24. Turn-On/Off Speed with CE Pin (D Version)
 ($V_{out} = 2.8$ V, $V_{in} = 3.8$ V, $C_{in} = 0.47$ μ F, $C_{out} = 0.47$ μ F)

NCP582

APPLICATION INFORMATION

Input Decoupling

A 1.0 μF ceramic capacitor is the recommended value to be connected between V_{in} and GND. For PCB layout considerations, the traces of V_{in} and GND should be sufficiently wide in order to minimize noise and prevent unstable operation.

Output Decoupling

It is best to use a 1.0 μF capacitor value when $V_{\text{out}} < 2.5\text{ V}$ and a 0.47 μF when $V_{\text{out}} \geq 2.5\text{ V}$. For better

performance, select a capacitor with low Equivalent Series Resistance (ESR). For PCB layout considerations, place the output capacitor close to the output pin and keep the leads as short as possible.

Noise Decoupling

The NCP582 series are low noise regulators and reach a noise level of only 30 μV_{rms} between 10 Hz and 100 kHz.

ORDERING INFORMATION

Device	Output Type / Features	Nominal Output Voltage	Marking	Package	Shipping†
NCP582DSQ15T1G	Active High w/Auto Discharge	1.5	SF	SC-82AB (Pb-Free)	3000 Tape & Reel
NCP582DSQ18T1G	Active High w/Auto Discharge	1.8	SJ	SC-82AB (Pb-Free)	3000 Tape & Reel
NCP582DSQ25T1G	Active High w/Auto Discharge	2.5	TF	SC-82AB (Pb-Free)	3000 Tape & Reel
NCP582DSQ28T1G	Active High w/Auto Discharge	2.8	TJ	SC-82AB (Pb-Free)	3000 Tape & Reel
NCP582DSQ30T1G	Active High w/Auto Discharge	3.0	UA	SC-82AB (Pb-Free)	3000 Tape & Reel
NCP582DSQ33T1G	Active High w/Auto Discharge	3.3	UD	SC-82AB (Pb-Free)	3000 Tape & Reel
NCP582LSQ15T1G	Active Low	1.5	JF	SC-82AB (Pb-Free)	3000 Tape & Reel
NCP582LSQ18T1G	Active Low	1.8	JJ	SC-82AB (Pb-Free)	3000 Tape & Reel
NCP582LSQ25T1G	Active Low	2.5	KF	SC-82AB (Pb-Free)	3000 Tape & Reel
NCP582LSQ28T1G	Active Low	2.8	KJ	SC-82AB (Pb-Free)	3000 Tape & Reel
NCP582LSQ30T1G	Active Low	3.0	LA	SC-82AB (Pb-Free)	3000 Tape & Reel
NCP582LSQ33T1G	Active Low	3.3	LD	SC-82AB (Pb-Free)	3000 Tape & Reel
NCP582DXV15T2G	Active High w/Auto Discharge	1.5	F15D	SOT-563 (Pb-Free)	4000 Tape & Reel
NCP582DXV18T2G	Active High w/Auto Discharge	1.8	F18D	SOT-563 (Pb-Free)	4000 Tape & Reel
NCP582DXV25T2G	Active High w/Auto Discharge	2.5	F25D	SOT-563 (Pb-Free)	4000 Tape & Reel
NCP582DXV28T2G	Active High w/Auto Discharge	2.8	F28D	SOT-563 (Pb-Free)	4000 Tape & Reel
NCP582DXV29T2G	Active High w/Auto Discharge	2.9	F29D	SOT-563 (Pb-Free)	4000 Tape & Reel
NCP582DXV30T2G	Active High w/Auto Discharge	3.0	F30D	SOT-563 (Pb-Free)	4000 Tape & Reel
NCP582DXV33T2G	Active High w/Auto Discharge	3.3	F33D	SOT-563 (Pb-Free)	4000 Tape & Reel
NCP582LXV15T2G	Active Low	1.5	F15A	SOT-563 (Pb-Free)	4000 Tape & Reel
NCP582LXV18T2G	Active Low	1.8	F18A	SOT-563 (Pb-Free)	4000 Tape & Reel
NCP582LXV25T2G	Active Low	2.5	F25A	SOT-563 (Pb-Free)	4000 Tape & Reel
NCP582LXV28T2G	Active Low	2.8	F28A	SOT-563 (Pb-Free)	4000 Tape & Reel
NCP582LXV29T2G	Active Low	2.9	F29A	SOT-563 (Pb-Free)	4000 Tape & Reel
NCP582LXV30T2G	Active Low	3.0	F30A	SOT-563 (Pb-Free)	4000 Tape & Reel
NCP582LXV33T2G	Active Low	3.3	F33A	SOT-563 (Pb-Free)	4000 Tape & Reel

†For information on tape and reel specifications, including part orientation and tape sizes, please refer to our Tape and Reel Packaging Specification Brochure, BRD8011/D.

Other voltages are available. Consult your ON Semiconductor representative.

NCP582

PACKAGE DIMENSIONS

SOT-563
XV SUFFIX
CASE 463A-01
ISSUE F

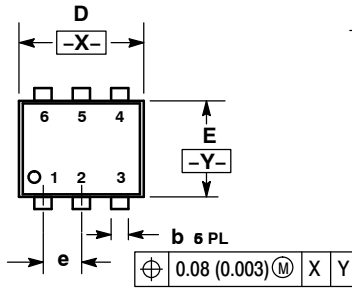

NOTES:

1. DIMENSIONING AND TOLERANCING PER ANSI Y14.5M, 1982.
2. CONTROLLING DIMENSION: MILLIMETERS
3. MAXIMUM LEAD THICKNESS INCLUDES LEAD FINISH THICKNESS. MINIMUM LEAD THICKNESS IS THE MINIMUM THICKNESS OF BASE MATERIAL.

DIM	MILLIMETERS			INCHES		
	MIN	NOM	MAX	MIN	NOM	MAX
A	0.50	0.55	0.60	0.020	0.021	0.023
b	0.17	0.22	0.27	0.007	0.009	0.011
C	0.08	0.12	0.18	0.003	0.005	0.007
D	1.50	1.60	1.70	0.059	0.062	0.066
E	1.10	1.20	1.30	0.043	0.047	0.051
e	0.5 BSC			0.02 BSC		
L	0.10	0.20	0.30	0.004	0.008	0.012
H _E	1.50	1.60	1.70	0.059	0.062	0.066

SOLDERING FOOTPRINT*

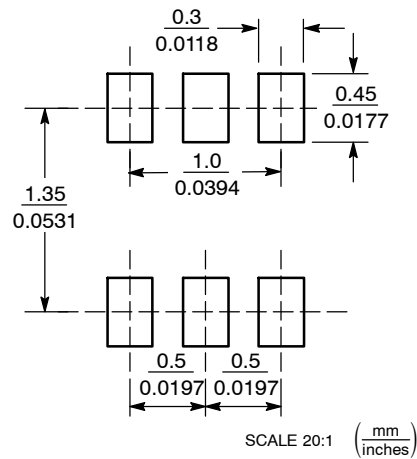

*For additional information on our Pb-Free strategy and soldering details, please download the ON Semiconductor Soldering and Mounting Techniques Reference Manual, SOLDERRM/D.

NCP582

PACKAGE DIMENSIONS

SC-82AB
SQ SUFFIX
CASE 419C-02
ISSUE E

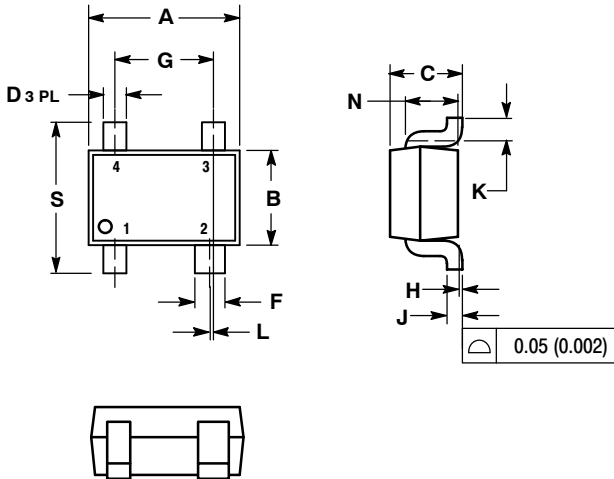

NOTES:

1. DIMENSIONING AND TOLERANCING PER ANSI Y14.5M, 1982.
2. CONTROLLING DIMENSION: MILLIMETER.
3. 419C-01 OBSOLETE. NEW STANDARD IS 419C-02.
4. DIMENSIONS A AND B DO NOT INCLUDE MOLD FLASH, PROTRUSIONS, OR GATE BURRS.

DIM	MILLIMETERS		INCHES	
	MIN	MAX	MIN	MAX
A	1.8	2.2	0.071	0.087
B	1.15	1.35	0.045	0.053
C	0.8	1.1	0.031	0.043
D	0.2	0.4	0.008	0.016
F	0.3	0.5	0.012	0.020
G	1.1	1.5	0.043	0.059
H	0.0	0.1	0.000	0.004
J	0.10	0.26	0.004	0.010
K	0.1	---	0.004	---
L	0.05 BSC		0.002 BSC	
N	0.2 REF		0.008 REF	
S	1.8	2.4	0.07	0.09

SOLDERING FOOTPRINT*

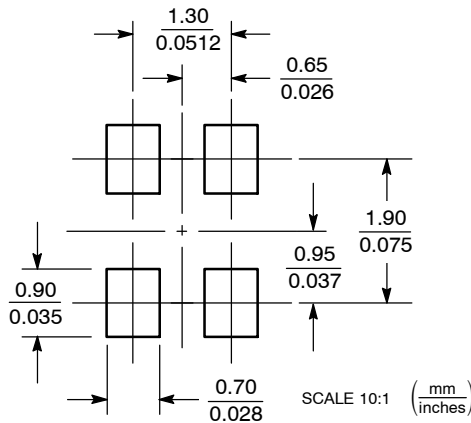

*For additional information on our Pb-Free strategy and soldering details, please download the ON Semiconductor Soldering and Mounting Techniques Reference Manual, SOLDERRM/D.

ON Semiconductor and are registered trademarks of Semiconductor Components Industries, LLC (SCILLC). SCILLC reserves the right to make changes without further notice to any products herein. SCILLC makes no warranty, representation or guarantee regarding the suitability of its products for any particular purpose, nor does SCILLC assume any liability arising out of the application or use of any product or circuit, and specifically disclaims any and all liability, including without limitation special, consequential or incidental damages. "Typical" parameters which may be provided in SCILLC data sheets and/or specifications can and do vary in different applications and actual performance may vary over time. All operating parameters, including "Typicals" must be validated for each customer application by customer's technical experts. SCILLC does not convey any license under its patent rights nor the rights of others. SCILLC products are not designed, intended, or authorized for use as components in systems intended for surgical implant into the body, or other applications intended to support or sustain life, or for any other application in which the failure of the SCILLC product could create a situation where personal injury or death may occur. Should Buyer purchase or use SCILLC products for any such unintended or unauthorized application, Buyer shall indemnify and hold SCILLC and its officers, employees, subsidiaries, affiliates, and distributors harmless against all claims, costs, damages, and expenses, and reasonable attorney fees arising out of, directly or indirectly, any claim of personal injury or death associated with such unintended or unauthorized use, even if such claim alleges that SCILLC was negligent regarding the design or manufacture of the part. SCILLC is an Equal Opportunity/Affirmative Action Employer. This literature is subject to all applicable copyright laws and is not for resale in any manner.

PUBLICATION ORDERING INFORMATION

LITERATURE FULFILLMENT:
Literature Distribution Center for ON Semiconductor
P.O. Box 5163, Denver, Colorado 80217 USA
Phone: 303-675-2175 or 800-344-3860 Toll Free USA/Canada
Fax: 303-675-2176 or 800-344-3867 Toll Free USA/Canada
Email: orderlit@onsemi.com

N. American Technical Support: 800-282-9855 Toll Free
USA/Canada
Europe, Middle East and Africa Technical Support:
Phone: 421 33 790 2910
Japan Customer Focus Center
Phone: 81-3-5773-3850

ON Semiconductor Website: www.onsemi.com
Order Literature: <http://www.onsemi.com/orderlit>

For additional information, please contact your local Sales Representative