



CSR1 & CSR2-B & E SERIES

POWER REGULATORS

CSR1/2-B/E

X10282

INTRODUCTION

The CSR Power Regulators are compact and robust units, which are capable of controlling single-phase mains driven loads of up to 15A. The CSR2 - series regulators come in two styles, open (type B) and enclosed (type E), with the enclosed version having its own integral heatsink. The regulator gives a fully adjustable output from zero to maximum voltage. The standard unit is rated for 110V and 230V ac, but other voltages are available on request.

APPLICATIONS

Suitable for conventional resistive heating elements such as ovens, quartz lamps, moulders and dryers. Also suitable for some inductive loads such as transformers, fans and motors.

RoHS Compliant
Directive
2002/95/EC

FEATURES

- Available in 6, 10, and 15 ampere ratings
- Compact and easy to use
- Simple installation - with or without heatsink
- Discrete component giving high reliability
- Cost effective

EXAMPLE - CSR2-15E



INSTALLATIONS

DIMENSIONS AND CONNECTIONS

CSR2 B SERIES

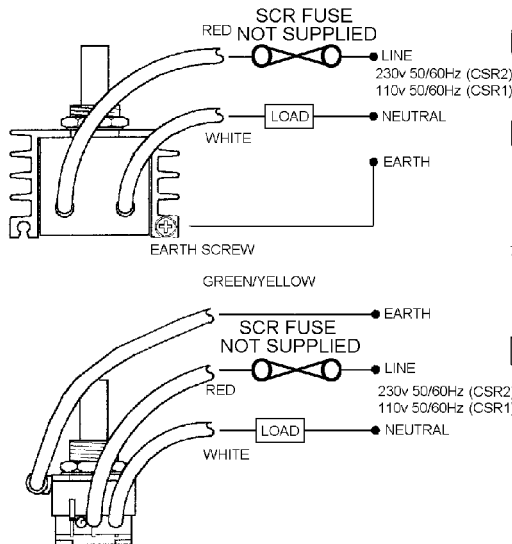
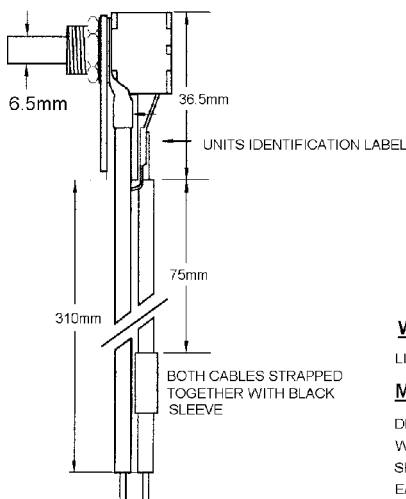
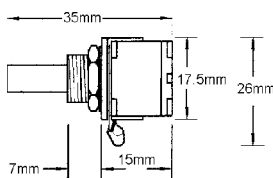

CSR2 E SERIES

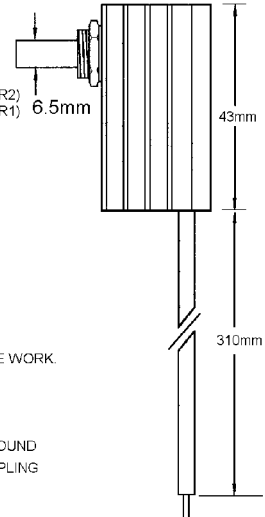
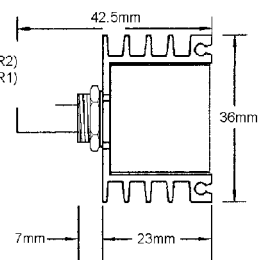

WARNING

LIVE TERMINALS - SWITCH OFF SUPPLY BEFORE COMMENCING ANY SERVICE WORK.

MOUNTING INSTRUCTIONS

DRILL A 10.3mm HOLE
WHEN FIXING CSR TO ADDITIONAL HEATSINK, A SMEAR OF HEATSINK COMPOUND SHOULD BE USED BETWEEN THE BONDED SURFACES TO AID THERMAL COUPLING
EARTH BONDING SHOULD BE ACHIEVED BETWEEN ALL MATING SURFACES

INSTALLATIONS

COOLING REQUIREMENTS

Heatsink rating v RMS maximum current

TO PREVENT IC OVERHEATING, THE CSR SHOULD BE FIXED FLUSH AND TIGHTLY TO A THERMALLY CONDUCTIVE PANEL OR HEATSINK WITH A SMEAR OF HEATSINK COMPOUND TO AID HEAT DISSIPATION

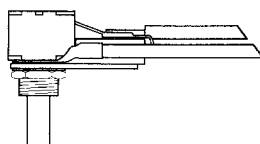

LOAD/AMPS	PANEL/HEATSINK RATING
BELOW 5	8°C/watt
AT 10	4°C/watt
AT 15	2°C/watt

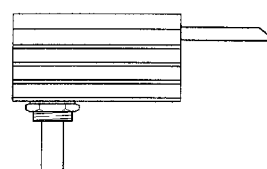
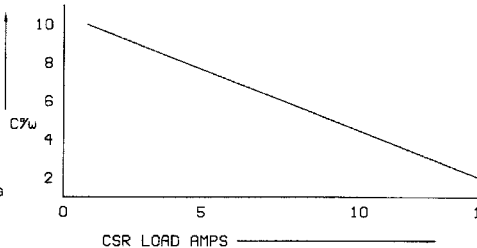

LOAD/AMPS	PANEL/HEATSINK RATING
BELOW 5	NONE
AT 10	4°C/watt
AT 15	2°C/watt

SPECIFICATIONS

UNIT TYPE

CSR1 (110V) & CSR2 (230V)

		6B	6E	10B	10E	15B	15E
Maximum on-state current, I _{max} (tab @ 70°C)	A (RMS)	6	6	10	10	15	15
Peak one cycle surge currents	A	100	100	120	120	150	150
Off - leakage current (maximum)	mA	----- 2 -----					
Minimum holding load current	mA	-----30-----					
RMS input voltage +/- 10% @ 50/60 Hz	V	----- 110 or 230 -----					
Repetitive peak voltage (tab @ 70°C)	V	----- 400 -----					
Hysteresis	%	----- 5 -----					
Total conduction phase angle (typical)	degrees	----- 0 to 160° -----					
Controlled phase angle (typical)	degrees	----- 30 to 160° -----					
Power transfer at I _{max} (efficiency)	%	----- 99 -----					
Tab surface operating range	°C	----- 0 to + 75 -----					
Storage temperature	°C	----- 0 to + 75 -----					
Insulation withstand capability (tab @ 70°C)	V	----- 1500 for 1 min. -----					
I ² t limiting values for fusing	A ² s	18	18	50	50	100	100
Mounting hole diameter (minimum)	mm	10.3	10.3	10.3	10.3	10.3	10.3

FUSING

It is recommended to use semiconductor (fast acting) type fuses or circuit breakers (semiconductor- MCB) for unit protection. On initial 'switch on' some loads may need an increased Factor of Safety (F of S) for unit and/or device protection. See SRA Data sheet for further information.

CE MARKING

This product family carries a "CE marking". These phase angle controllers need a suitable remote filter. For more information see *recommendations* section and contact our sales desk.

RECOMMENDATIONS

Other documents available on request, which may be appropriate for your applications:-

CODE	IDENTITY	DESCRIPTION
X10229	RFI	Filtering recommendation - addressing EMC Directive.
X10213	ITA	Interaction, uses for phase angle and for burst fire control.
X10255	SRA	Safety requirements - addressing the Low Voltage Directive (LVD) including :- Thermal data/cooling ; "Live" parts warning & Earth requirements; Fusing recommendations.
AP02/4	COS	UAL Conditions of sale.

NOTE It is recommended that installation and maintenance of this equipment should be done with reference to the current edition of the I.E.E. wiring regulations (BS7671) by suitably qualified/trained personnel. The regulations contain important requirements regarding safety of electrical equipment.
(For International Standard refer to I.E.C. directive IEC 950).

ORDER CODE: State part number: **CSR1 or 2** (Denotes supply voltage) + (current rating) + type 'B' or 'E'

Optional extras include: Knob, Dial, Heatsink compound, Filters.

Note: When ordering a filter, the current the CSR is to be used at will be required.



UNITED AUTOMATION LIMITED

1 Southport Business Park
Kew
Southport, PR8 4HQ
ENGLAND

Tel: 0044 (0) 1704 - 516500
Fax: 0044 (0) 1704 - 516501

e-mail: enquiry@united-automation.com

Page No. 2 of 2

Issue 3

Date 7/03/03



This document was created with Win2PDF available at <http://www.win2pdf.com>.
The unregistered version of Win2PDF is for evaluation or non-commercial use only.
This page will not be added after purchasing Win2PDF.